

ABERDEEN

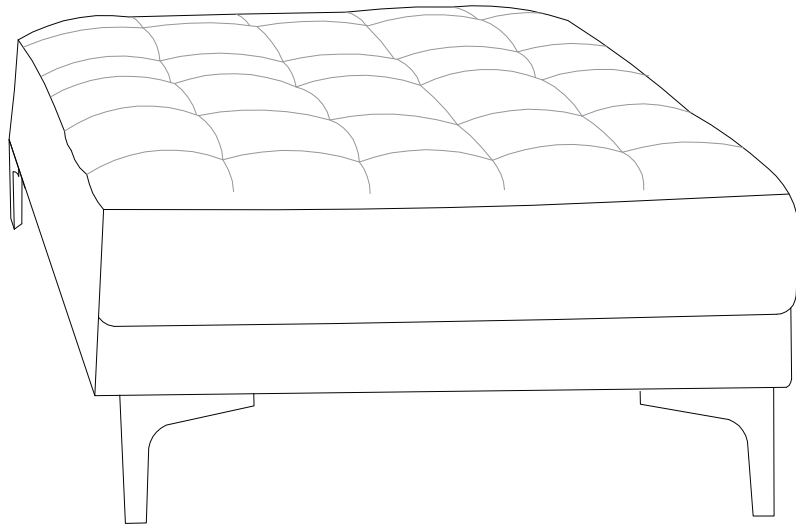

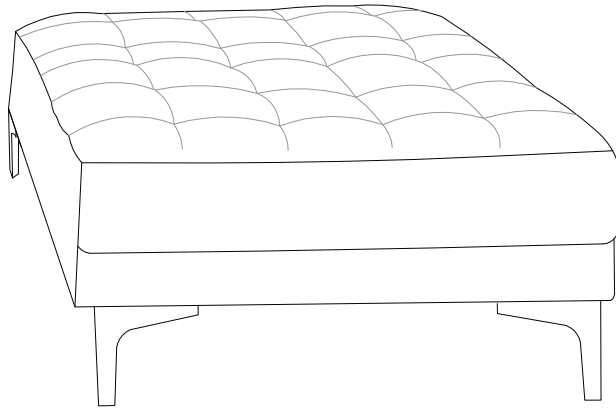

Assembly instructions for the ottoman, showing two steps with warnings, a 10-minute time limit, and a one-person requirement.

Step 1: A circular icon shows a screwdriver. A power drill is shown with a diagonal line through it, indicating it should not be used. A warning triangle with an exclamation mark is to the right. A clock icon with a circular arrow and the number 10' indicates a 10-minute time limit.

Step 2: A circular icon shows a rectangular block being placed on a textured mat. A diagram shows the block being secured with a screw. A warning triangle with an exclamation mark is to the right. A person icon and the number 1 indicate that one person is required for this step.

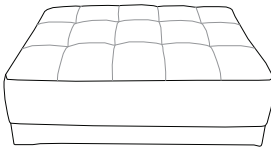
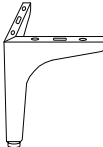
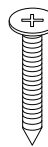
<p>A</p>  <p>x 1</p>	<p>B</p>  <p>x 4</p>	<p>C</p>  <p>M4 x 30</p> <p>x 16</p>
---	---	--

A

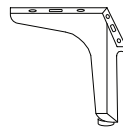
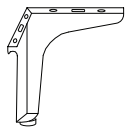
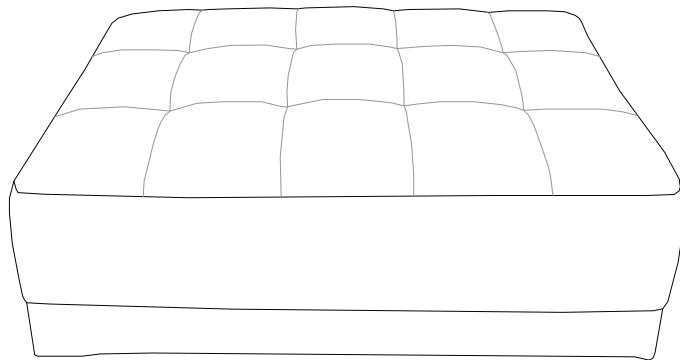

B x 4

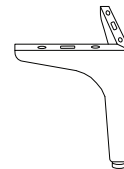
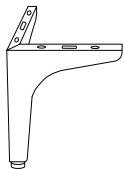

!

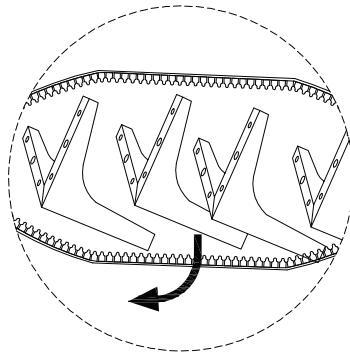
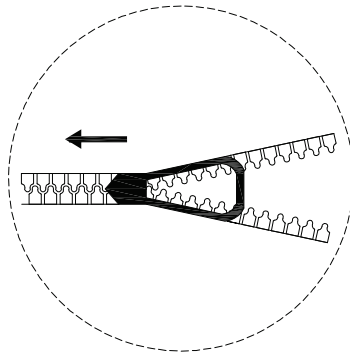
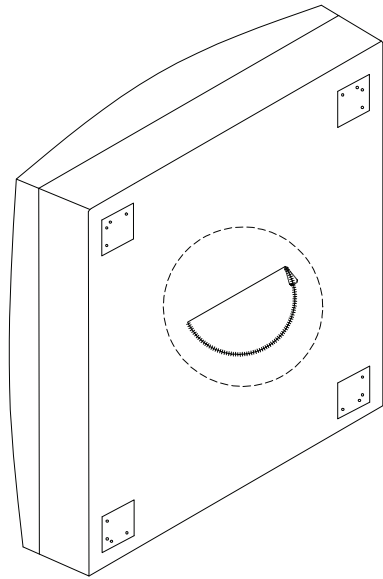

1

