

## SITIA RELAX SOFA

MODEL NO.:1403

RATED VOLTAGE: DC 29V

PUISSANCE NOMINALE: 50W

IMPORTE VENTE UNIQUE.COM

9/11 RUE JACQUARD 93310 LE PRE SAINT-GERVAIS FRANCE

### Maintenance and Notes

1. Please use it under the required voltage;
2. The working temperature is 0- 40°C;
3. According to the required "1 minute work/ 8 minutes rest", if continued operation is required, please make sure to operate no more than 2 minutes;
4. Do not disassemble by yourself, if there is any questions please contact our after-sales staff.
5. Do not operate near fire or in high temperature ambient
6. Do not expose to water or other conductive liquid electric shock hazard.

This appliance can be used by children aged from 8 years and above and persons with reduced physical, sensory or mental capabilities or lack of experience and knowledge if they have been given supervision or instruction concerning use of the appliance in a safe way and understand the hazards involved.

Children shall not play with the appliance. Cleaning and user maintenance shall not be made by children without supervision.

The appliance is only to be used with power supply unit provided with the appliance.

The external flexible cable of the transformer cannot be replaced, if the cord of this transformer is damaged, it is necessary to dispose the transformer and replaced by transformer of the same model.

### Leather Care & Maintenance

Because leather is a natural product, we recommend proper care during normal usage.

We recommend frequent dusting with a clean cloth to prevent the pores from clogging.

## CORRECT DISPOSAL OF THIS PRODUCT

	<p>This marking indicates that this product should not be disposed with other household wastes throughout the EU. To prevent possible harm to the environment or human health from uncontrolled waste disposal, recycle it responsibly to promote the sustainable reuse of material resources. To return your used device, please use the return and collection systems or contact the retailer where the product was purchased. They can take this product for environmental safe recycling.</p>
---	---



# NOTICE DE MONTAGE

## NOTE OF ASSEMBLY / INSTRUCCIONES DE MONTAJE / MONTAGE-ANLEITUNG

REFERENCE NO.: REFERENCE NO.: REFERENCIA NO: REFERENZ NR:	1403 LV
PRODUCT NAME: NOMBRE DEL PRODUCTO: PRODUCTOS: PRODUKTBEZEICHNUNG:	SITIA



- 1.Reperez les pieces constituant votre meuble
- 2.Regroupez et comptez la quincaillerie.
- 3.Munissez-vous de l'outillage necessaire
- 4.Amenagez-vous une zone de montage,la moquette ou couverture protegera des rayures
- 5.Procedez au montage,ne jamais forcer sur les assemblages,resserez-les apres quelques temps d'usage.

GARDEZ VOTRE NOTICE DE MONTAGE.

SI UNE PIECE VENAIT A MANQUER ELLE SERA LE MOYEN LE PLUS CLAIR POUR COMMUNIQUER AVEC VOTRE MAGASIN.



- 1.Identify the parts which make up your piece of furniture.
- 2.Gather the hardware parts and count them.
- 3.Have the necessary tools ready.
- 4.Organize a space for assembly,wall carpeting or a blanket will protect the furniture against scratches.
- 5.Mount the furniture,never force the parts to be assembled.

TIGHTEN THE SCREWS AFTFTER IT HAS BEEN USED FOR SOME TIME.

KEEP THE ASSEMBLY INSTRUCTION SINCE IT WILL HELP YOU WHEN YOU GET IN TOUCH THE STORE IF A PART SHOULD BE MISSING.



- 1.Localice las piezas que componen su mueble.
- 2.Reagrupe y cuente la tornilleria.
- 3.Prepare las herramientas necesarias.
- 4.Prepare una zona de montaje,la moqueta o una manta protgerá de arañazo.
- 5.Proceda al montaje,no forzar sobre los embalages,apretar los tornillos despues de algún tiempo de uso.

GUARDAR LAS INSRTUCCIONES DE MONTAJE.

SI UNA PIEZA LE FALTESE,SERA LA MANERA MAS FACIL DE COMUNICARSE CON SU PROVEEDOR.









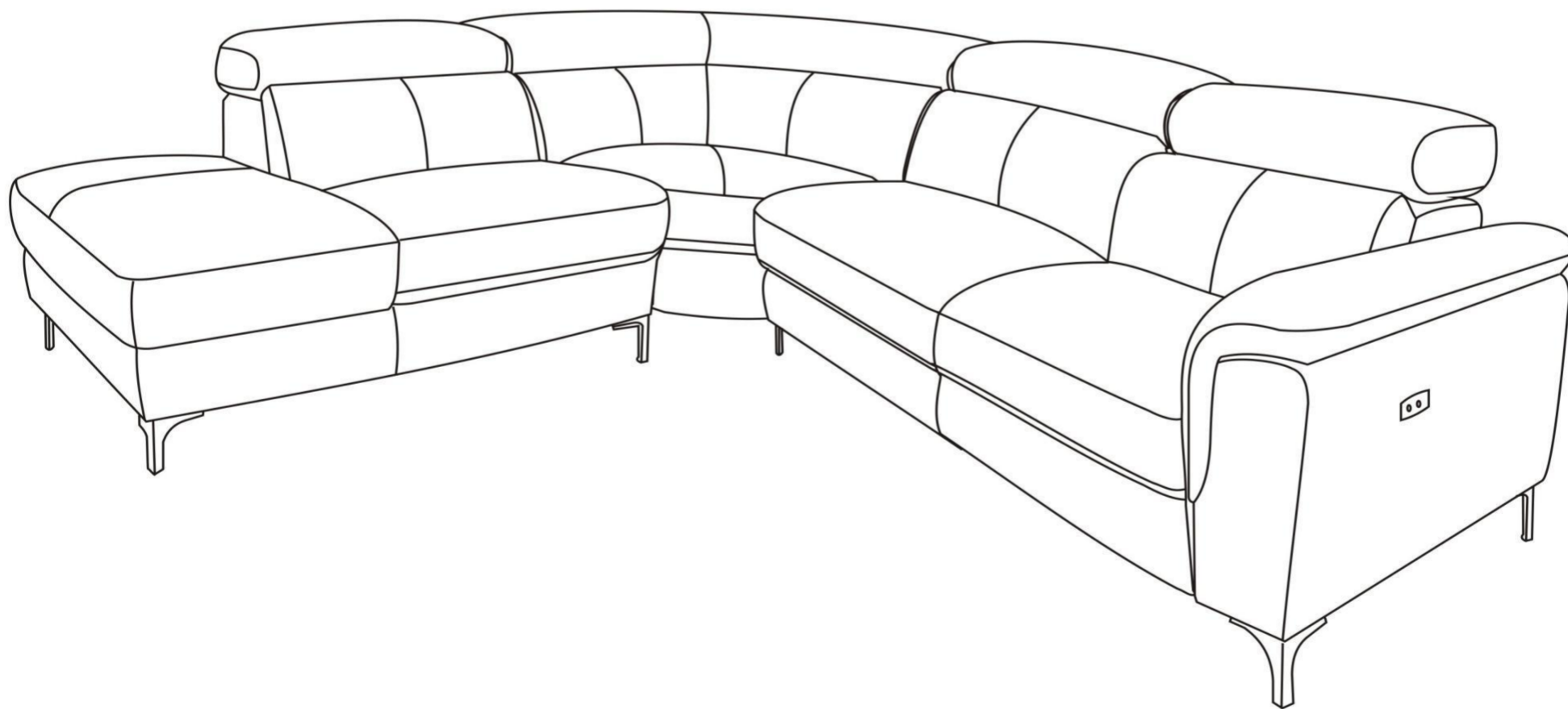

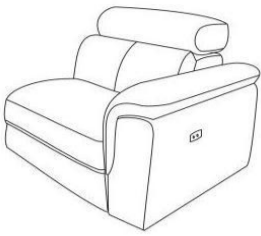

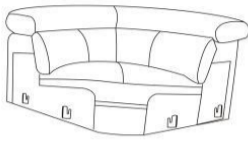
- 1.Bitte überprüfen Sie,ob alle Einzelteile Ihres Möbelstücks vorhanden sind.
- 2.Bitte überprüfen Sie,ob alle Schrauben und Verbindungsteile für die Montage vorhanden sind.
- 3.Halten Sie alle notwendigen Montage-Werkzeuge für ihren Einsatz gebrauchsbereit.
- 4.Bereiten Sie einen passen Ort für die Montage vor.Ein Teppichboden oder ähnliches schützt vor Kratzern.
- 5.Beginnen Sie mit der Montage.Lassen Sie sich Zeit und fügen Sie die Einzelteile nie mit Gewalt zusammen.

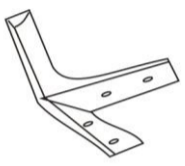
Um einen langfristigen und einwandfreien Gebrauch zu gewährleisten,ziehen Sie die einzelnen Schrauben regelmäßig nach längerer Nutzung des Möbelstücks fest.

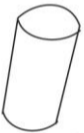
Bitte bewahren Sie diese Montageanleitung auf.Diese gewährleistet im Problemfall einen reibungslosen undschnellen Kommunikationsaustausch mit dem Kundeservice Ihres Geschäfts.



NOM NAME NOMBRE	ILLUSTRATION ILLUSTRATION IMAGEN	TAILLE SIZE TALLA	QUANTITÉ QUANTITY QUANTIDAD	NOM NAME NOMBRE	ILLUSTRATION ILLUSTRATION IMAGEN	TAILLE SIZE TALLA	QUANTITÉ QUANTITY QUANTIDAD
A		105x100x70/88cm	1pc	B		79x100x70/88cm	1pc
C		116x116x70cm	1pc	D		140x103x70/88cm	1pc
L1 LEG		13.5x13.5x12cm	13pcs	SCREW		H3.5cm	52pcs
L2 LEG		H12cm	3pc	L3 LEG		H10cm	1pc
 <p><b>TEMPS DE MONTAGE: 1/3 HEURE</b>  <b>TIEMPO DE MONTAJE: 1/3 HORA</b>  <b>SET-UP TIME: 1/3 HOUR</b></p>  <p><b>NOMBRE DE PERSONNES: 02</b>  <b>NUMERO DE PERSONAS: 02</b>  <b>NUMBER OF PERSONS: 02</b></p>  <p><b>POUR L'ENTRETIEN, UN CHIFFON DOUX SUFFIRA.</b>  <b>PARA EL CUIDADO GENERAL, UN PEDAZO DE PAÑO SERÁ SUFICIENTE.</b>  <b>FOR GENERAL CARE, A PIECE OF CLOTH WILL BE ENOUGH.</b></p>							

**1. Take off all the black plastic legs.**

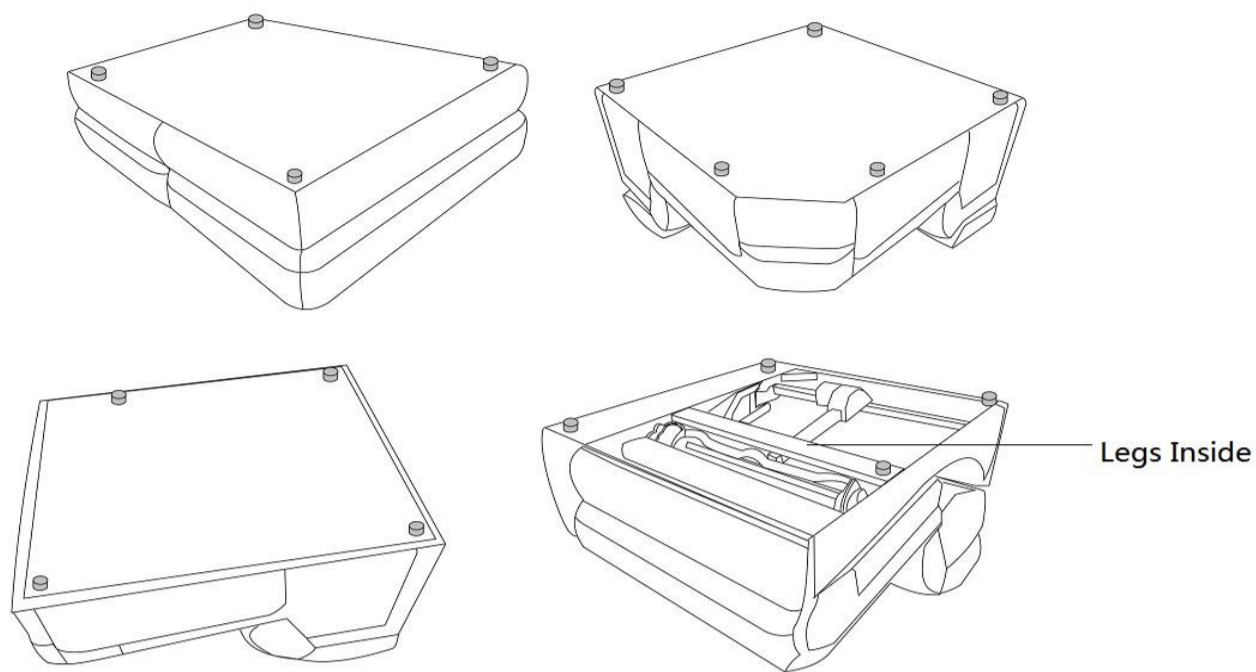

**2. Take the legs from bottom. Screw all the stainless legs**

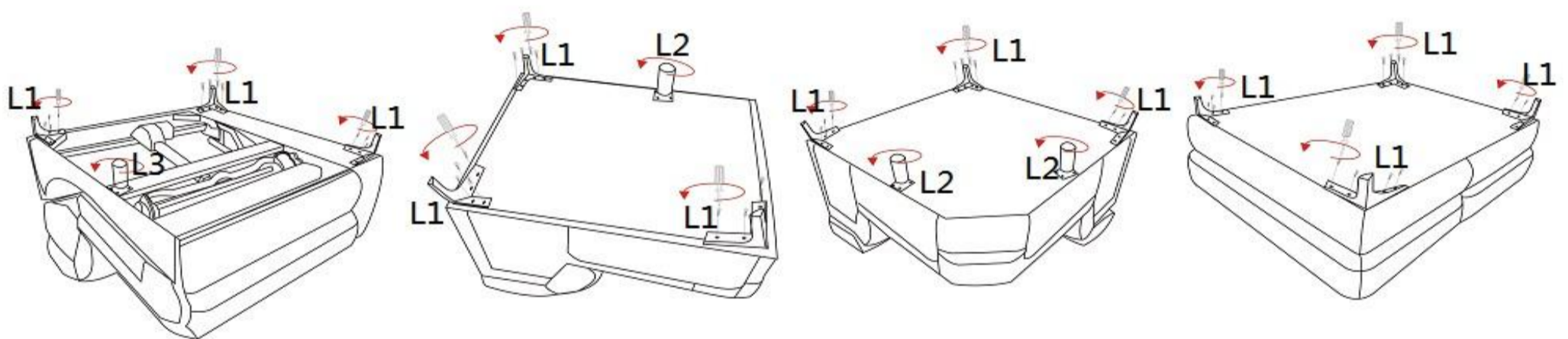

**3. Assemble the four parts together.**

