

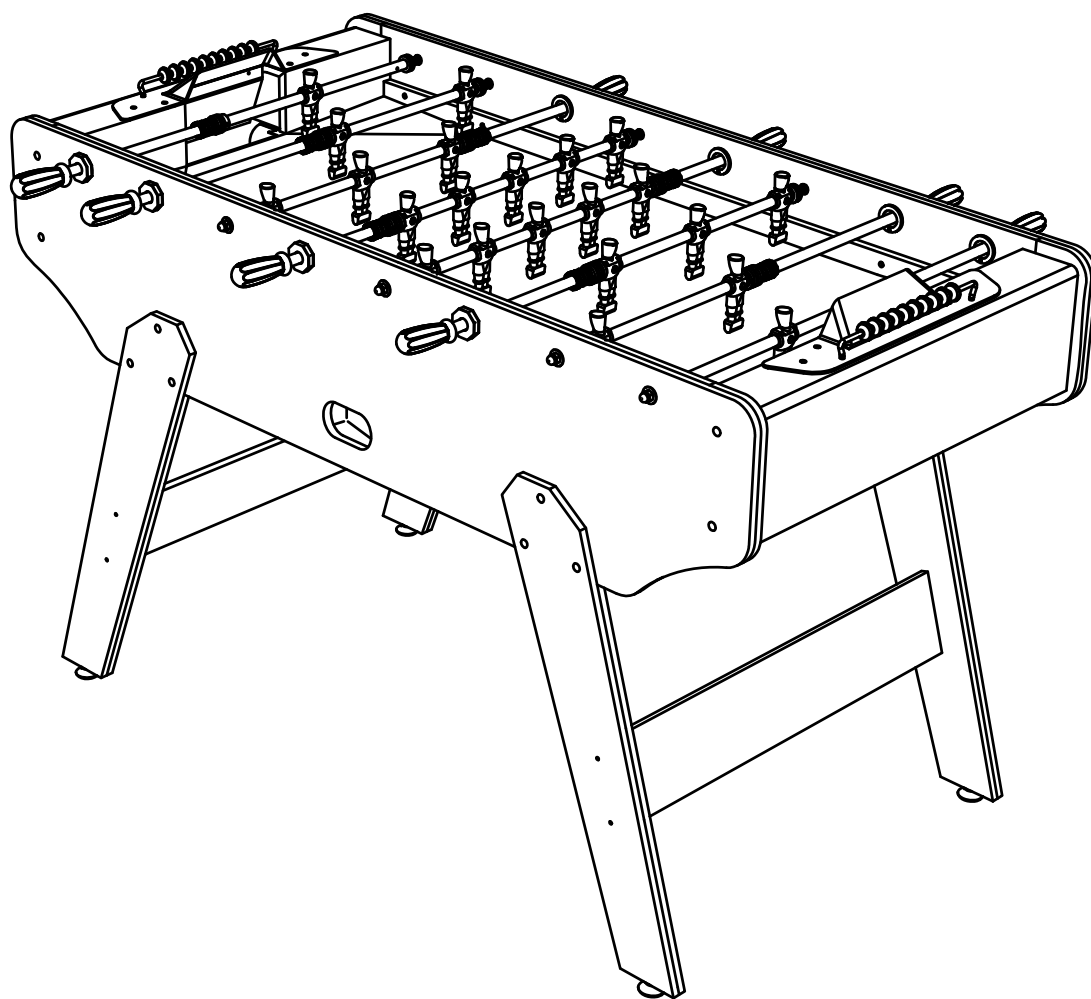

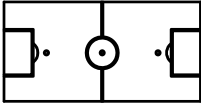

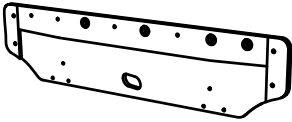

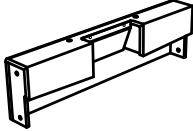

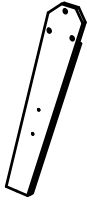
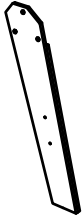

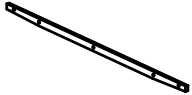



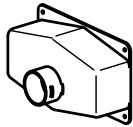

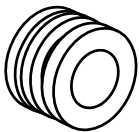
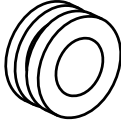



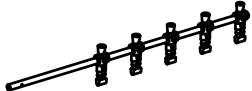

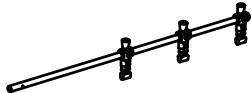
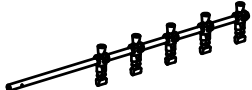

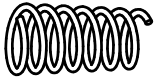
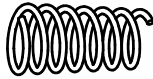



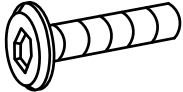



INSTRUCTION MANUAL FOR SOCCER TABLE GS-ST-1484

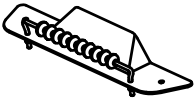
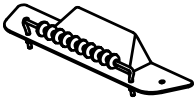

<p>#1</p>  <p>Playfield 1 pc</p>	<p>#2</p>  <p>Side Apron 2 pcs</p>	<p>#3</p>  <p>Goal end board 2 pcs</p>	<p>#4</p>  <p>R Leg 2 pcs</p>
<p>#5</p>  <p>L Leg 2 pcs</p>	<p>#6</p>  <p>Field support brace 2 pcs</p>	<p>#7</p>  <p>Leg end panel 2 pcs</p>	<p>#8</p>  <p>Decorative batten-1 2 pcs</p>
<p>#9</p>  <p>Decorative batten-2 2 pcs</p>	<p>#10</p>  <p>Decorative batten-3 2 pcs</p>	<p>#11</p>  <p>Goal Box 2 pcs</p>	<p>#12</p>  <p>Ball catcher 2 pcs</p>
<p>#13</p>  <p>Rod handle 8 pcs</p>	<p>#14</p>  <p>Plastic washer 6 pcs</p>	<p>#15</p>  <p>Plastic washer 2 pcs</p>	<p>#16</p>  <p>Plastic washer 8 pcs</p>
<p>#17</p>  <p>1-man rod(red or white) 1 pc</p>	<p>#18</p>  <p>2-man rod(red or white) 1 pc</p>	<p>#19</p>  <p>3-man rod(red or white) 1 pc</p>	<p>#20</p>  <p>5-man rod(red or white) 1 pc</p>
<p>#21</p>  <p>1-man rod(blue or black) 1 pc</p>	<p>#22</p>  <p>2-man rod(blue or black) 1 pc</p>	<p>#23</p>  <p>3-man rod(blue or black) 1 pc</p>	<p>#24</p>  <p>5-man rod(blue or black) 1 pc</p>

<p>#25</p>  <p>support rod 8 pcs</p>	<p>#26</p>  <p>Spring-1 8 pcs</p>	<p>#27</p>  <p>Spring-2 8 pcs</p>	<p>#28</p>  <p>Nut 8 pcs</p>
<p>#29</p>  <p>Washer 5/16" 16 pcs</p>	<p>#30</p>  <p>Player Rod Bearing-A 8 pcs</p>	<p>#31</p>  <p>Player Rod Bearing-B 8 pcs</p>	<p>#32</p>  <p>Bolt 5/16"X38mm 20 pcs</p>
<p>#33</p>  <p>Washer 5/16"X23mm 20 pcs</p>	<p>#34</p>  <p>ScrewT4X63mm 8 pcs</p>	<p>#35</p>  <p>ScrewF4X32mm 18 pcs</p>	<p>#36</p>  <p>ScrewT3X25mm 22 pcs</p>
<p>#37</p>  <p>ScrewT4X12mm 12 pcs</p>	<p>#38</p>  <p>ScrewT4X16mm 8 pcs</p>	<p>#39</p>  <p>ScrewF4X14mm 8 pcs</p>	<p>#40</p>  <p>Leg Levelers 4 pcs</p>
<p>#41</p>  <p>Ball runner 2 pcs</p>	<p>#42</p>  <p>Scorer(red or white) 1 pc</p>	<p>#43</p>  <p>Scorer(blue or black) 1 pc</p>	<p>#44</p>  <p>Wrench 1 pc</p>
<p>#45</p>  <p>Wrench 1 pc</p>	<p>#46</p>  <p>Ball 10 pcs</p>		

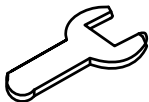
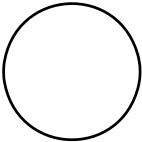
STEP 1:

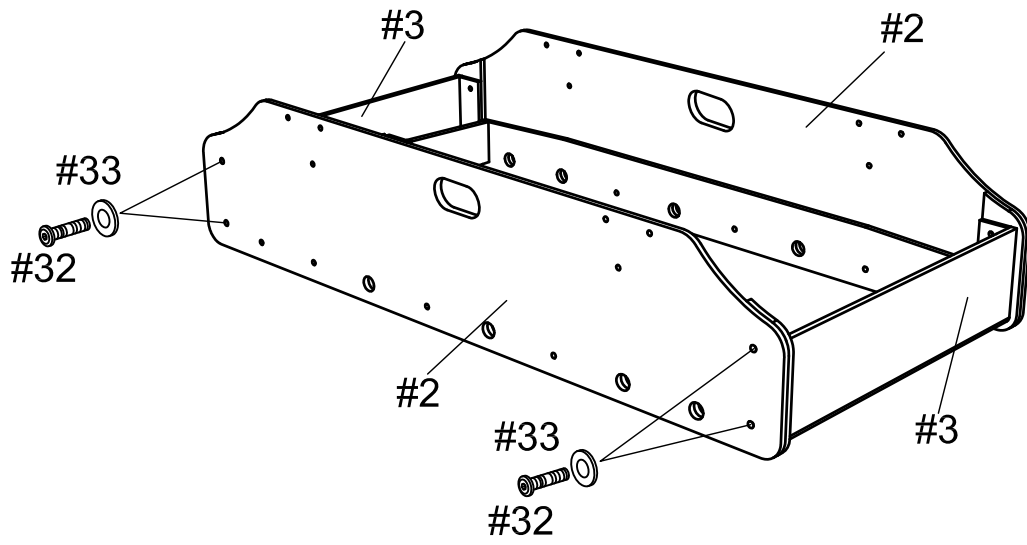

STEP 2:

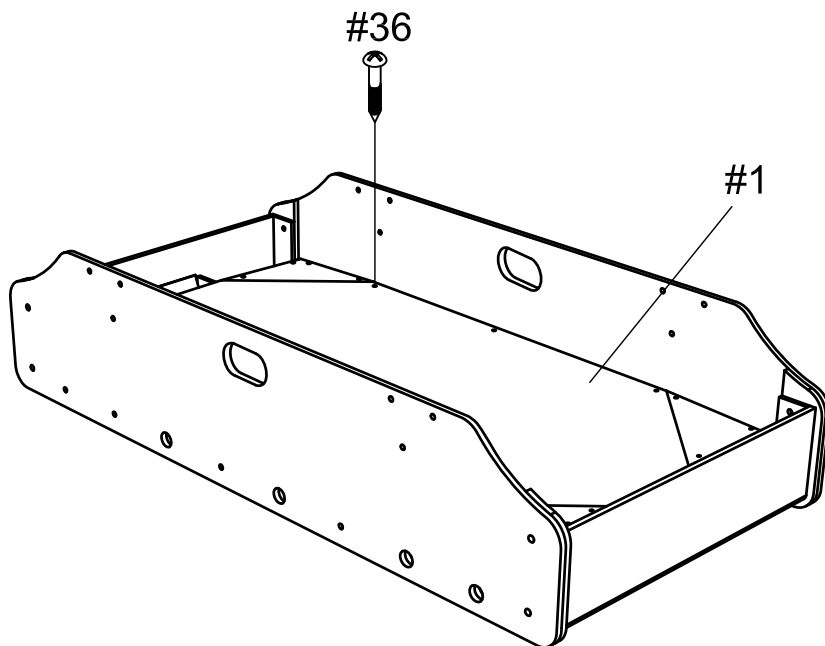

STEP 3:

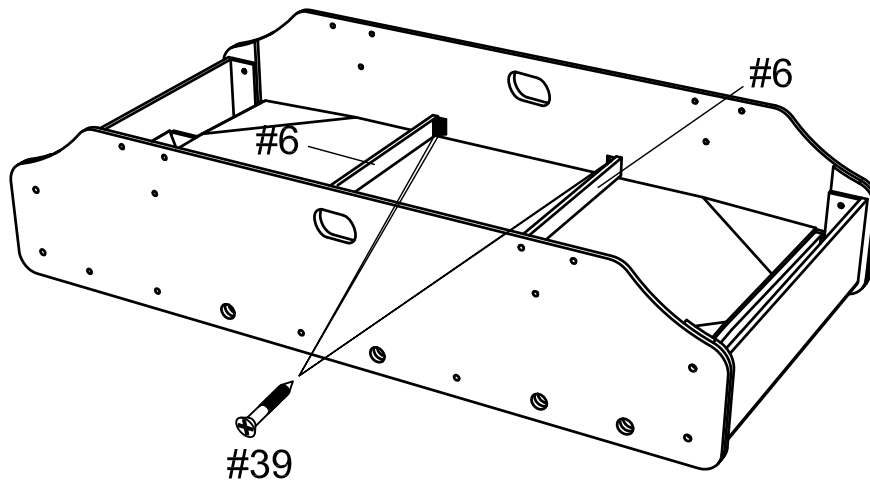

STEP 4:

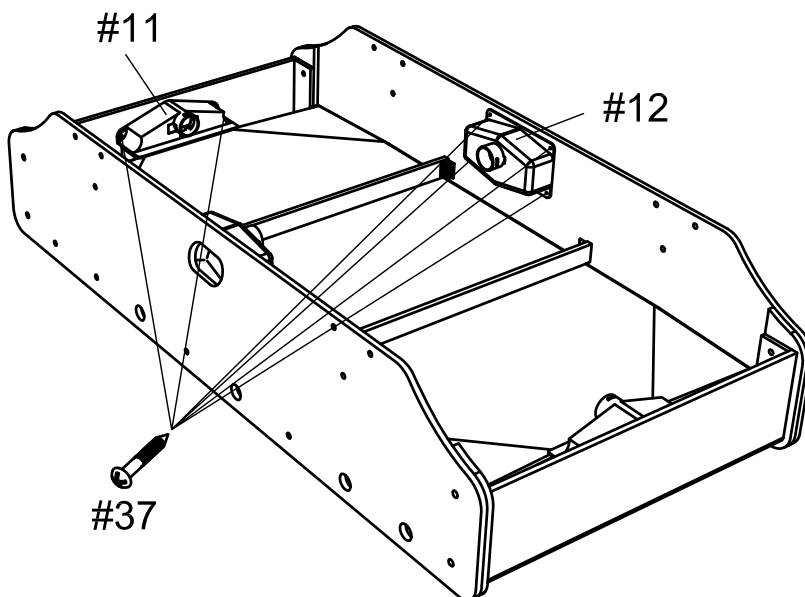
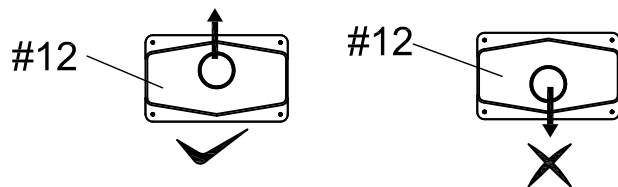

STEP 5:

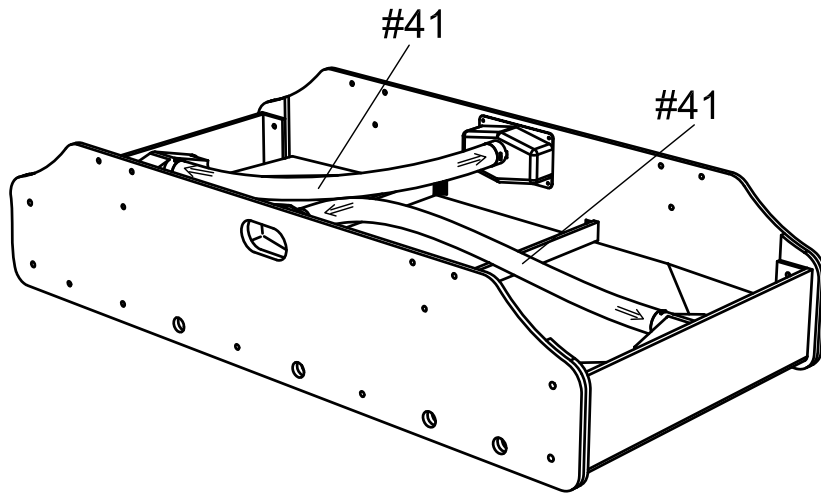

STEP 6:

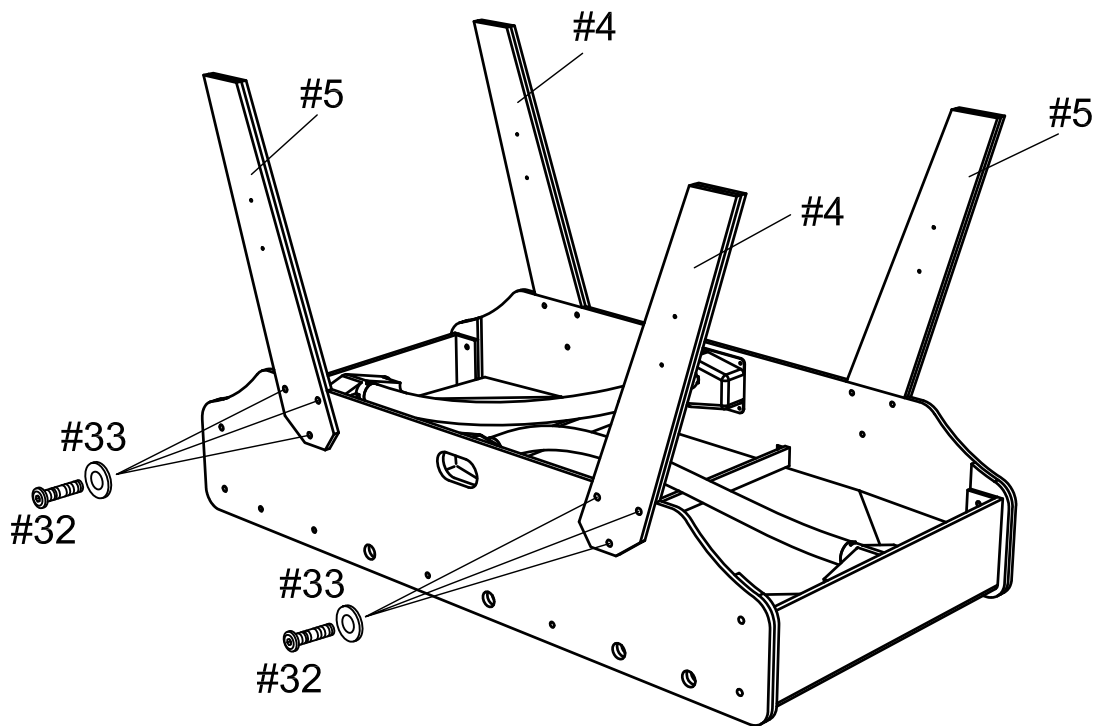

STEP 7:

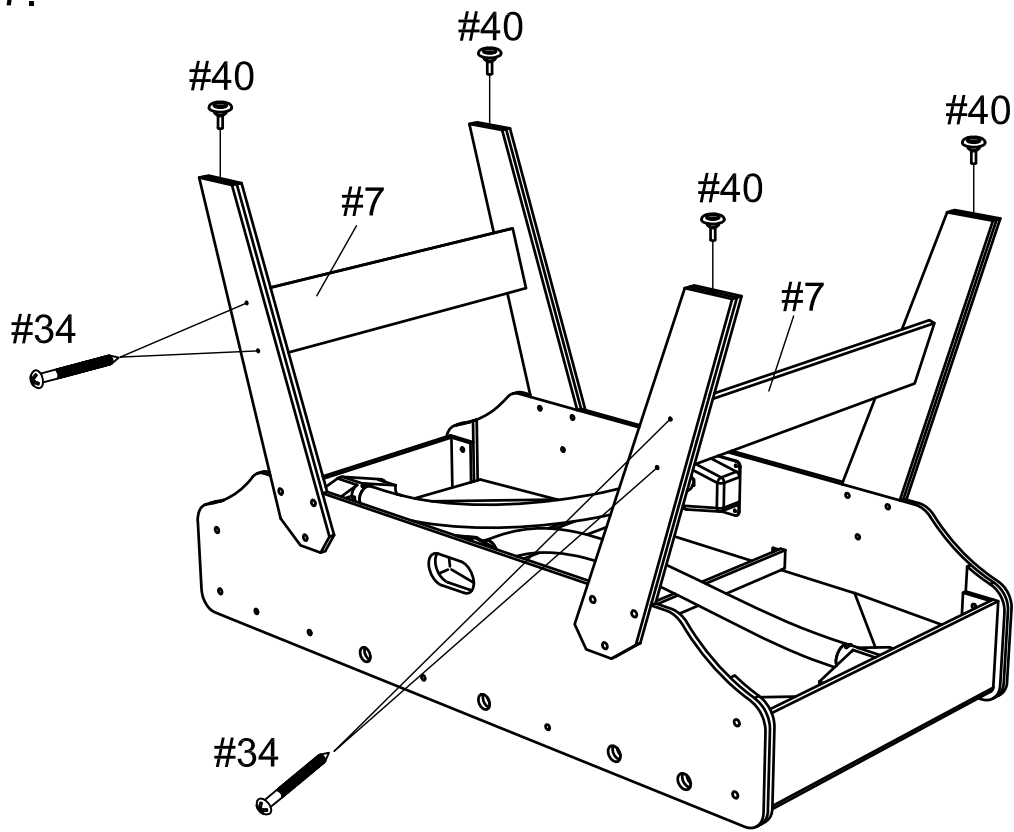

STEP 8:

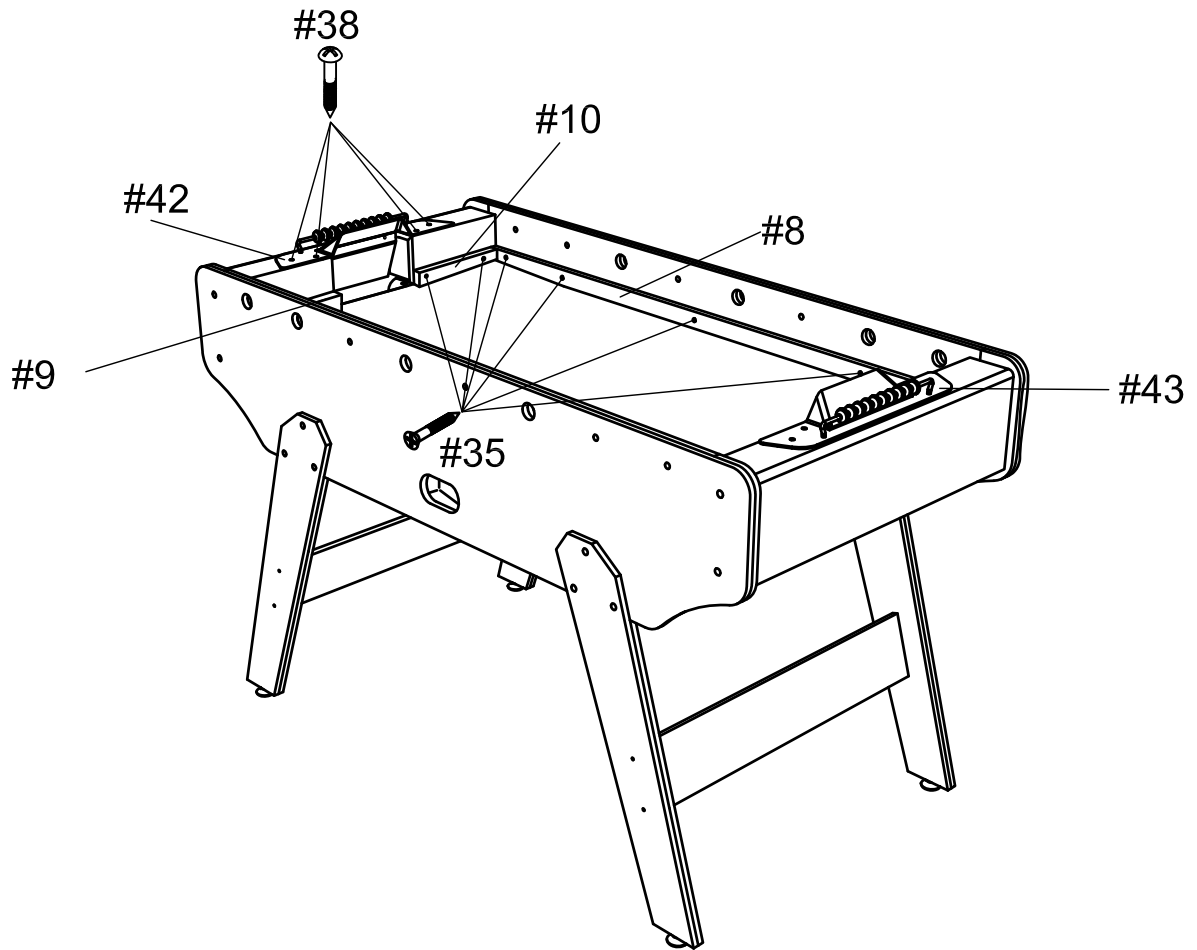

STEP 9:

