

# HEDEN

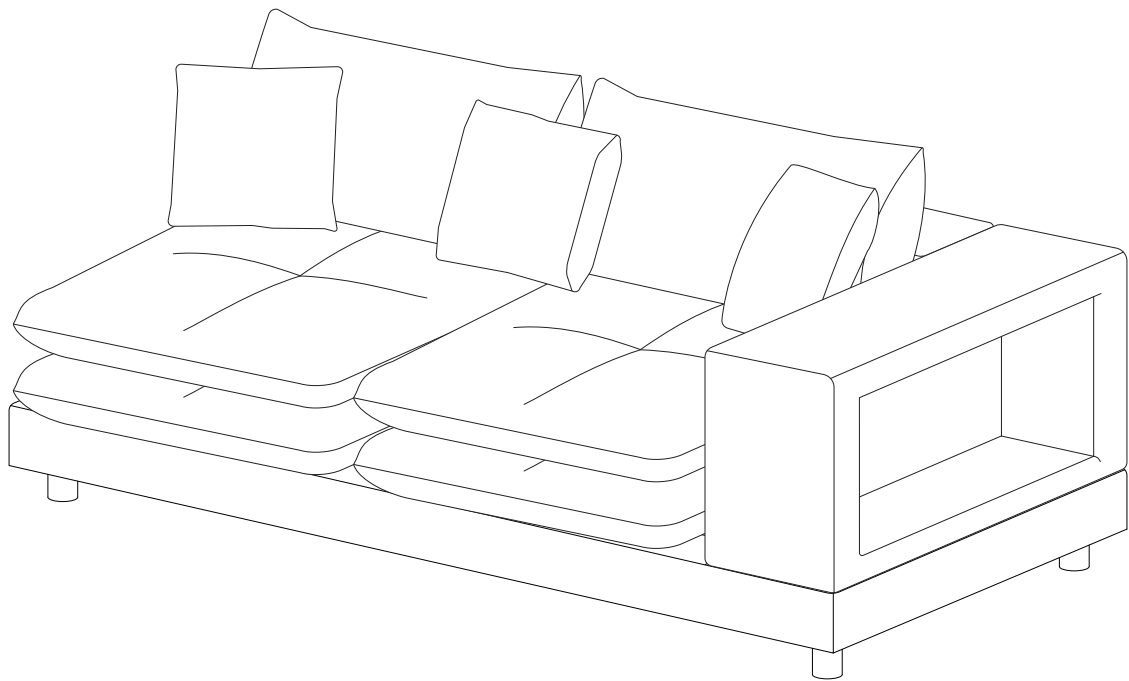

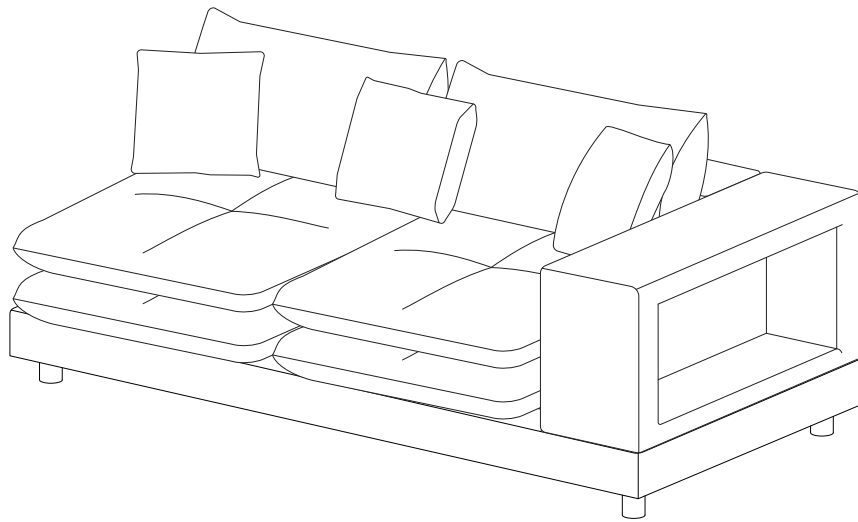

		15'
		2

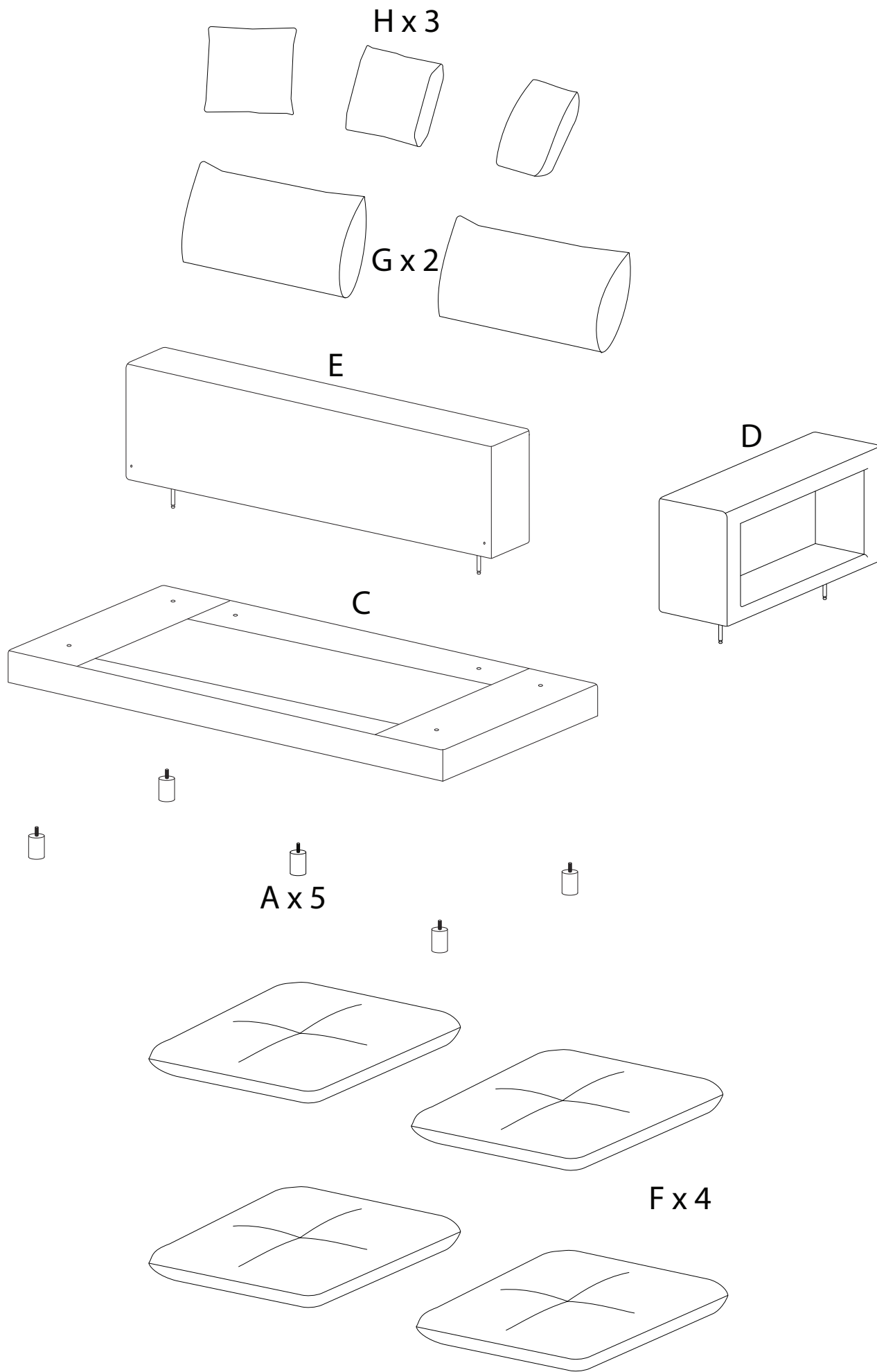

A

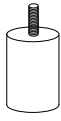

x 5

B



x 5

C

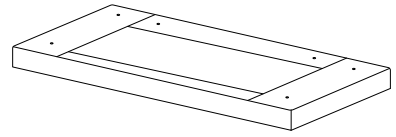

x 1

D

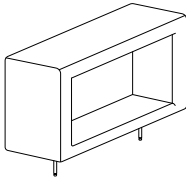

x 1

E

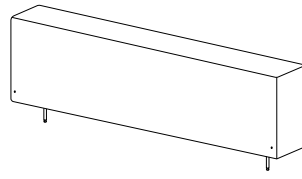

x 1

F



x 4

G

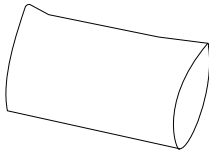

x 2

H

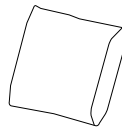

x 3

I



x 2

J

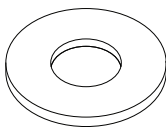

x 2

K

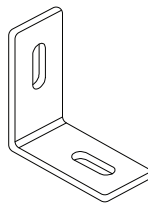

x 1

L

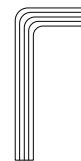

x 1

!

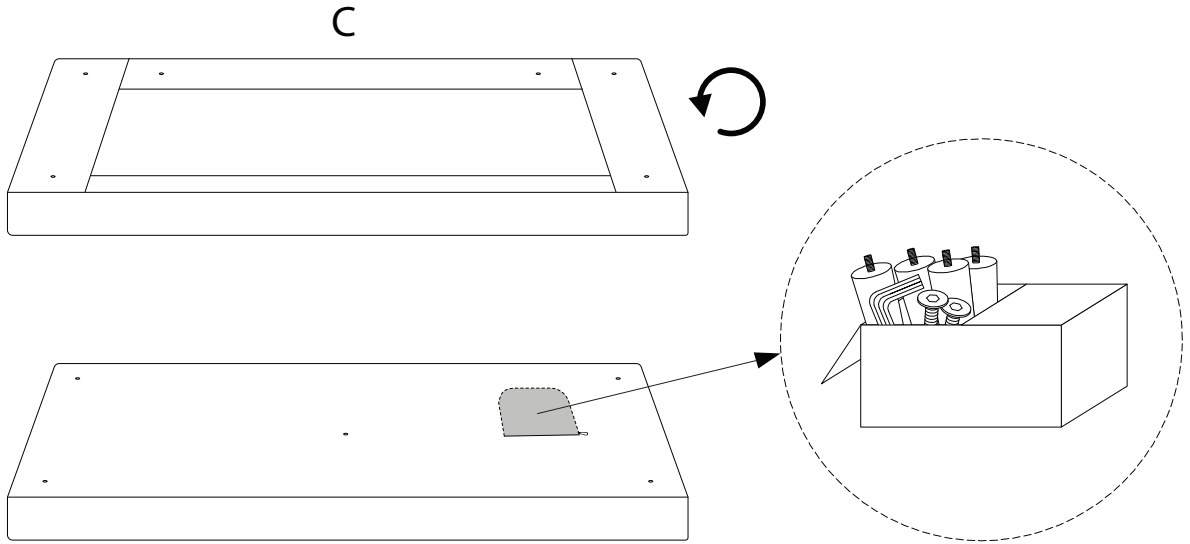

!

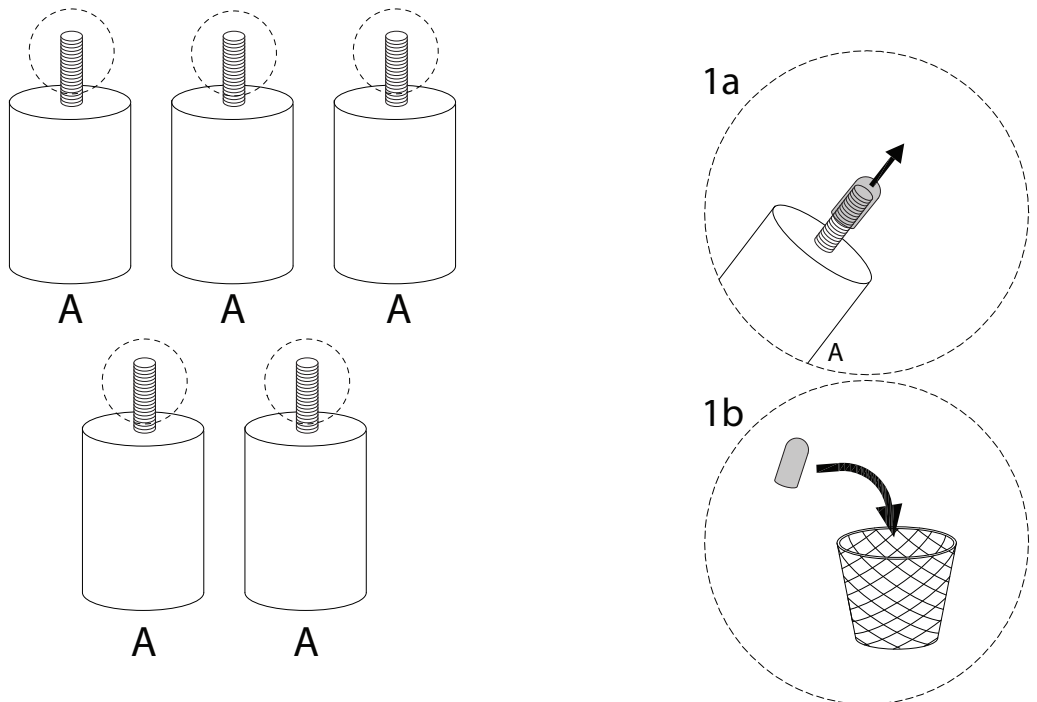

1

A



x 5

C

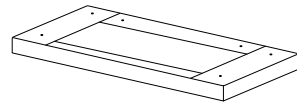

x 1

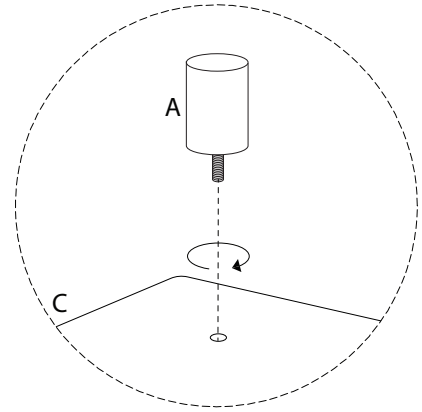
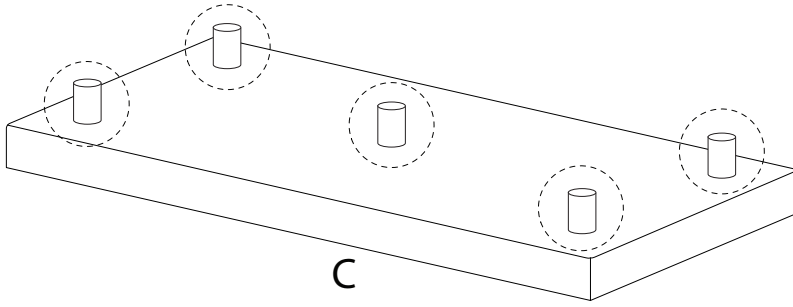

2

B



x 5

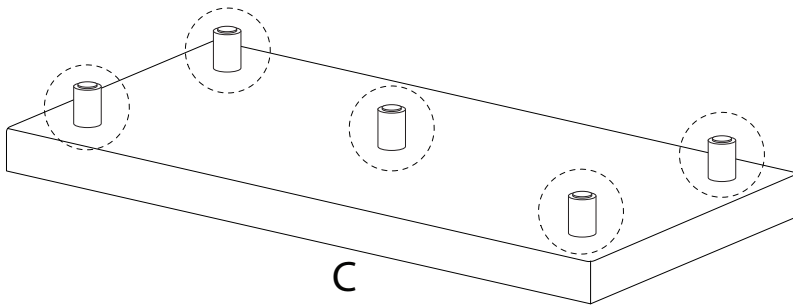

1a

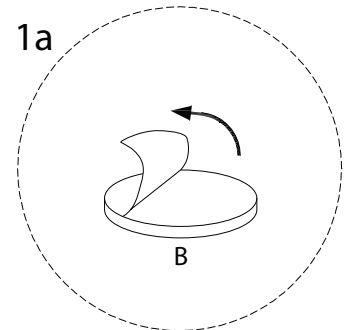

1b

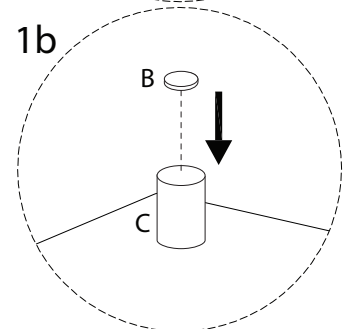

3

D

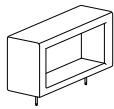

x 1

E

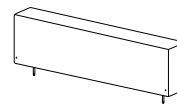

x 1

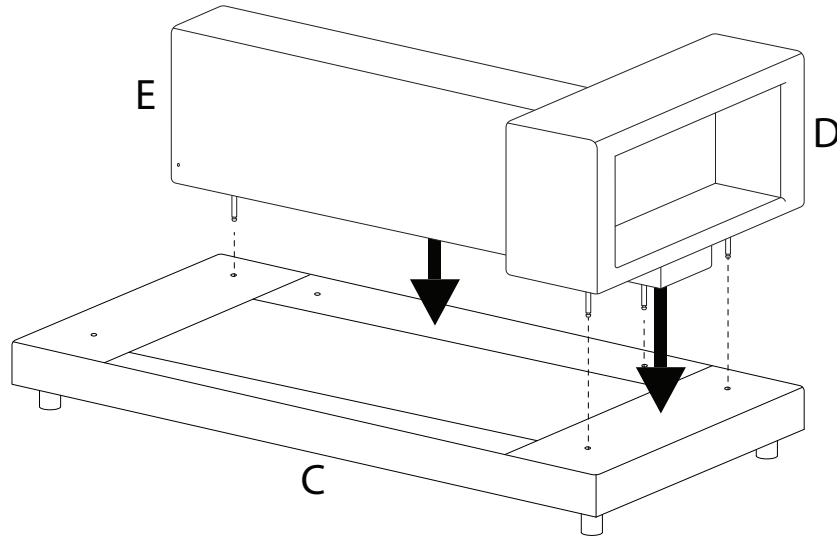

4

I



x 2

J

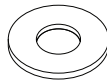

x 2

K



x 1

L



x 1

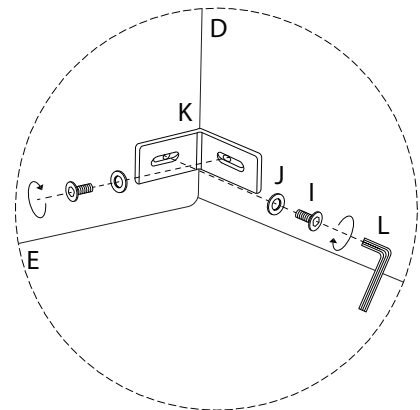
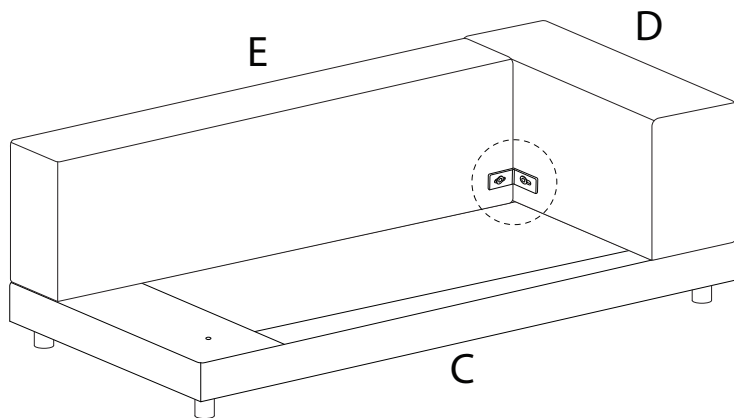

5

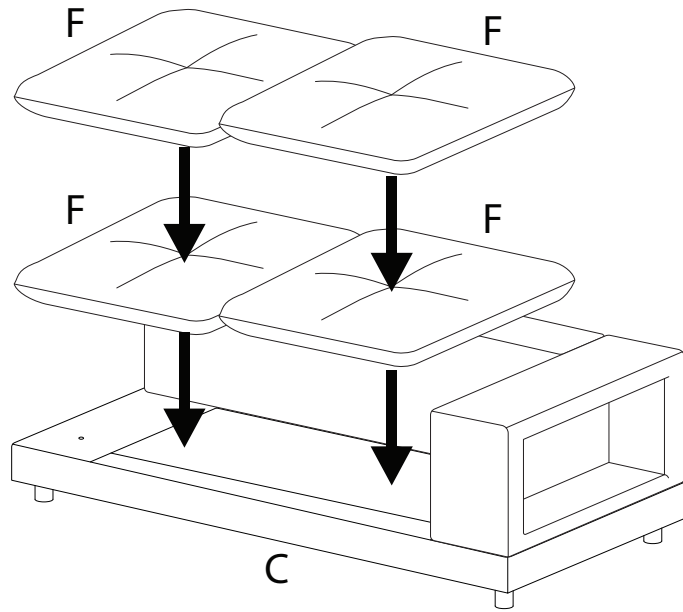
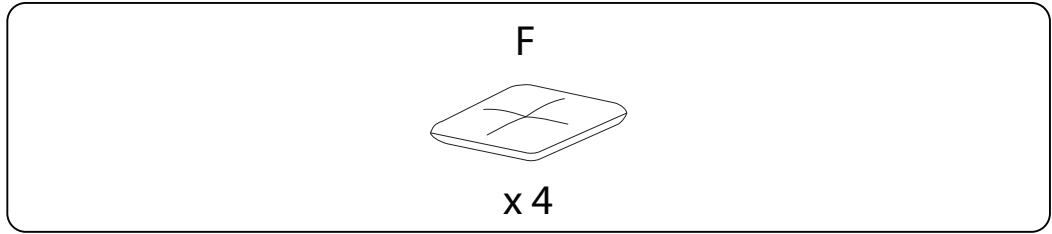

6

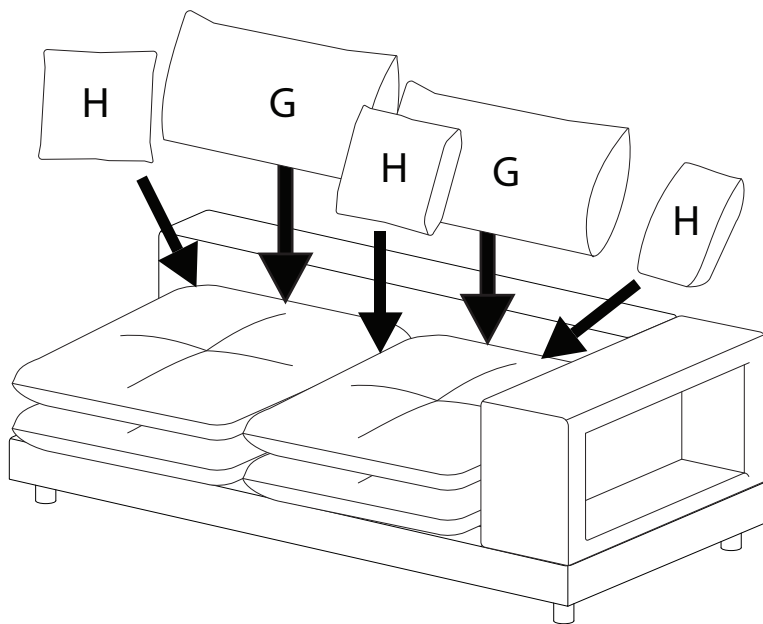
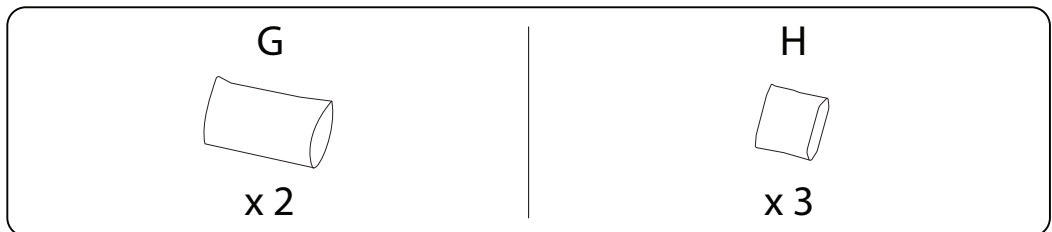



!

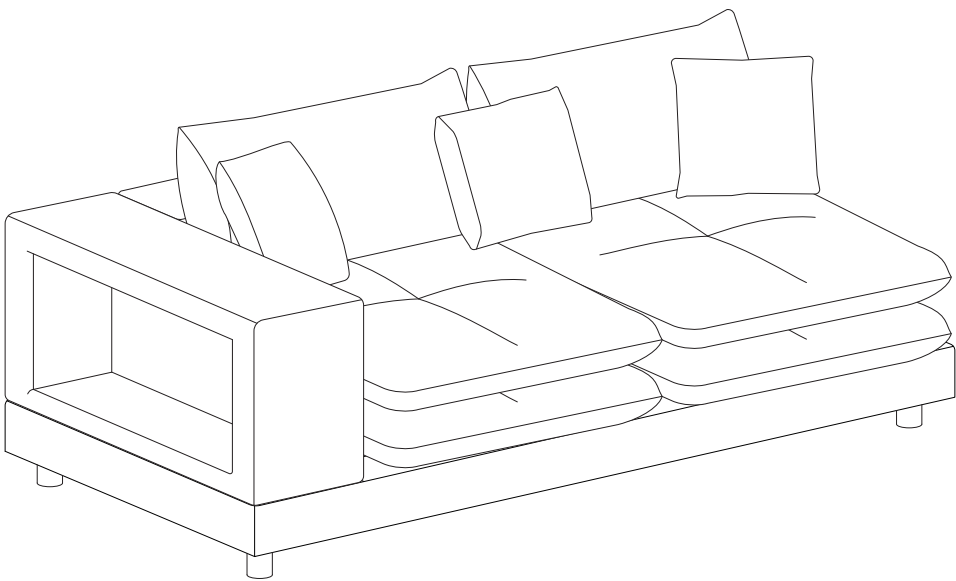
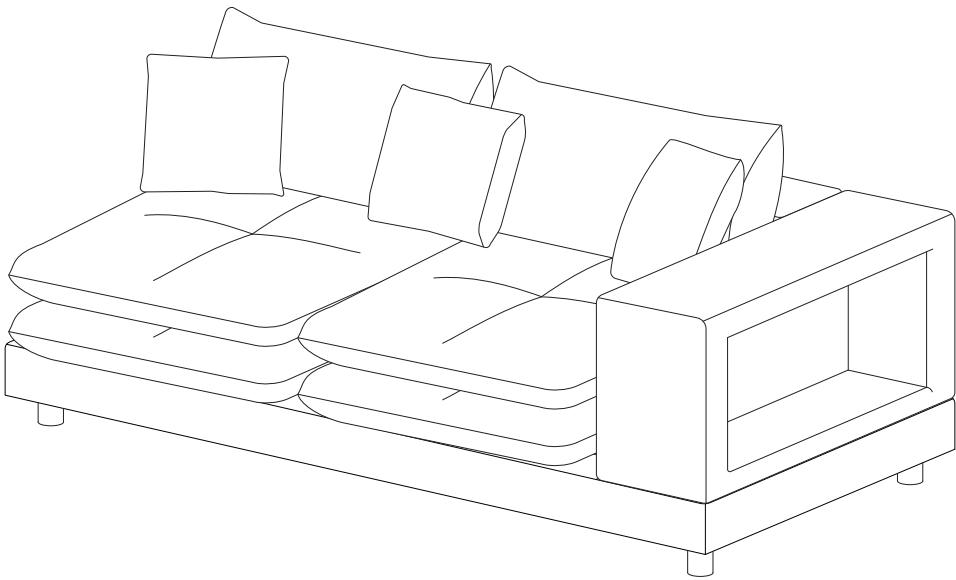

!

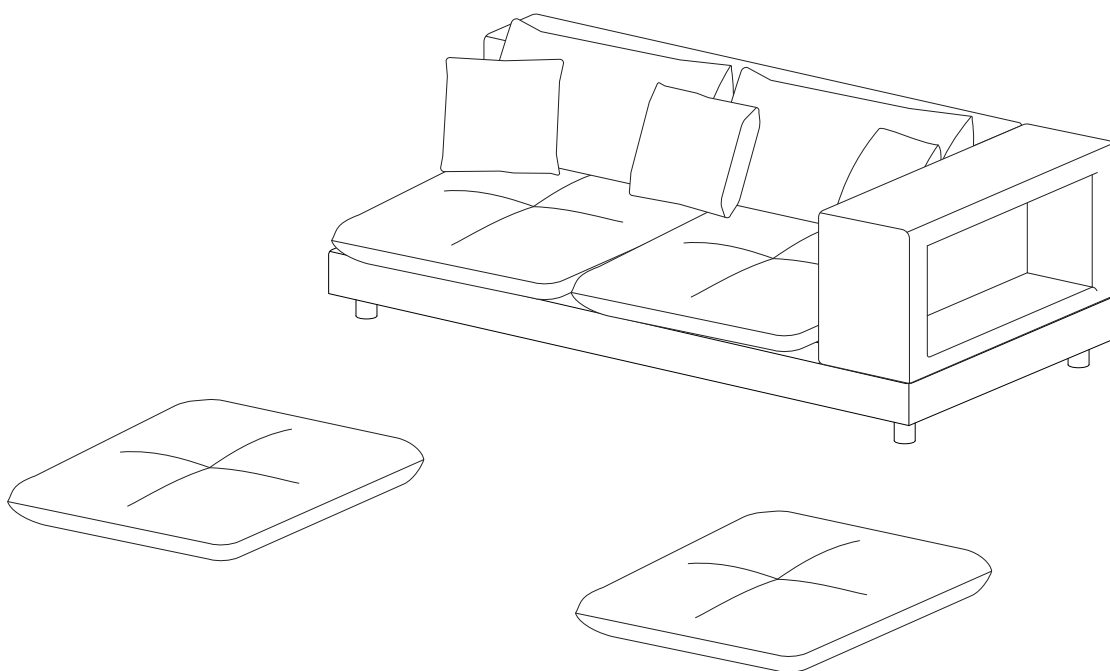

!

