

FR Description du produit

EN Product description

ES Descripción del producto

DE Produktbeschreibung

IT Descrizione del prodotto

NL Productomschrijving

PT Descrição do produto

PL Opis produktu

Matelas



Vente-unique.com

Français (FR)

Lisez attentivement cette notice avant d'utiliser le matelas.

- Conservez cette notice pour référence future.
- Ne laissez pas les sacs en plastique à portée des enfants. Risque d'étouffement.
- Déballez le matelas dans une pièce bien ventilée.
- Respecter le temps de décompression de 72 heures avant utilisation.
- Déployez le matelas sur une surface plane et propre.
- Assurez-vous que le matelas soit correctement positionné sur le support recommandé.
- Ne placez pas le matelas près d'une flamme ouverte ou d'une source de chaleur.

English (EN)

Read this manual carefully before using the mattress.

- Keep this manual for future reference.
- Do not leave plastic bags within the reach of children. Risk of suffocation.
- Unpack the mattress in a well-ventilated room.
- Allow 72 hours for decompression before use.
- Place the mattress on a clean, flat surface.
- Ensure the mattress is properly positioned on the recommended support.
- Do not place the mattress near an open flame or heat source.

Deutsch (DE)

Lesen Sie diese Anleitung sorgfältig durch, bevor Sie die Matratze verwenden.

- Bewahren Sie diese Anleitung für zukünftige Referenz auf.
- Plastiktüten nicht in Reichweite von Kindern lassen. Erstickungsgefahr.
- Packen Sie die Matratze in einem gut belüfteten Raum aus.
- Lassen Sie die Matratze 72 Stunden zur Entfaltung ruhen, bevor Sie sie verwenden.
- Legen Sie die Matratze auf eine saubere, ebene Fläche.
- Stellen Sie sicher, dass die Matratze korrekt auf der empfohlenen Unterlage positioniert ist.
- Platzieren Sie die Matratze nicht in der Nähe von offenen Flammen oder Wärmequellen.

Italiano (IT)

Leggere attentamente queste istruzioni prima di utilizzare il materasso.

- Conservare queste istruzioni per riferimento futuro.
- Non lasciare i sacchetti di plastica alla portata dei bambini. Rischio di soffocamento.
- Disimballare il materasso in una stanza ben ventilata.
- Attendere 72 ore per la decompressione prima dell'uso.
- Posizionare il materasso su una superficie piana e pulita.
- Assicurarsi che il materasso sia correttamente posizionato sul supporto raccomandato.
- Non posizionare il materasso vicino a fiamme libere o fonti di calore.

Español (ES)

Lea atentamente este manual antes de usar el colchón.

- Conserve este manual para futuras consultas.
- No deje bolsas de plástico al alcance de los niños. Riesgo de asfixia.
- Desempaque el colchón en una habitación bien ventilada.
- Espere 72 horas para que el colchón se descomprima antes de usarlo.
- Coloque el colchón sobre una superficie limpia y plana.
- Asegúrese de que el colchón esté correctamente colocado sobre el soporte recomendado.

- No coloque el colchón cerca de llamas abiertas o fuentes de calor.
-

Português (PT)

Leia atentamente este manual antes de usar o colchão.

- Guarde este manual para referência futura.
 - Não deixe sacos plásticos ao alcance de crianças. Risco de asfixia.
 - Desembale o colchão em um local bem ventilado.
 - Aguarde 72 horas para a descompressão antes de usar.
 - Coloque o colchão sobre uma superfície limpa e plana.
 - Certifique-se de que o colchão esteja corretamente posicionado no suporte recomendado.
 - Não coloque o colchão próximo a chamas abertas ou fontes de calor.
-

Polski (PL)

Przeczytaj uważnie tę instrukcję przed użyciem materaca.

- Zachowaj tę instrukcję na przyszłość.
 - Nie pozostawiaj plastikowych toreb w zasięgu dzieci. Ryzyko uduszenia.
 - Rozpakuj materac w dobrze wentylowanym pomieszczeniu.
 - Odczekaj 72 godziny na pełne rozłożenie przed użyciem.
 - Umieść materac na czystej i płaskiej powierzchni.
 - Upewnij się, że materac jest prawidłowo umieszczony na zalecanym podparciu.
 - Nie umieszczaj materaca w pobliżu otwartego ognia ani źródeł ciepła.
-

Nederlands (NL)

Lees deze handleiding zorgvuldig door voordat u de matras gebruikt.

- Bewaar deze handleiding voor toekomstig gebruik.
- Laat plastic zakken niet binnen het bereik van kinderen. Verstikkingsgevaar.
- Pak de matras uit in een goed geventileerde ruimte.
- Laat de matras 72 uur decomprimeren voordat u deze gebruikt.
- Leg de matras op een schone, vlakke ondergrond.
- Zorg ervoor dat de matras correct is geplaatst op het aanbevolen ondersteuningssysteem.
- Plaats de matras niet in de buurt van een open vlam of warmtebron.



Vente-unique.com

VS-Jul-2024

Imported by - Importé par

CAFOM DISTRIBUTION

9 Rue Jacquart 93310 Le Pré-Saint-Gervais

FR Description du produit

EN Product description

ES Descripción del producto

DE Produktbeschreibung

IT Descrizione del prodotto

NL Productomschrijving

PT Descrição do produto

PL Opis produktu

Matelas



Vente-unique.com

Français (FR)

Lisez attentivement cette notice avant d'utiliser le matelas.

- Conservez cette notice pour référence future.
- Ne laissez pas les sacs en plastique à portée des enfants. Risque d'étouffement.
- Déballez le matelas dans une pièce bien ventilée.
- Respecter le temps de décompression de 72 heures avant utilisation.
- Déployez le matelas sur une surface plane et propre.
- Assurez-vous que le matelas soit correctement positionné sur le support recommandé.
- Ne placez pas le matelas près d'une flamme ouverte ou d'une source de chaleur.

English (EN)

Read this manual carefully before using the mattress.

- Keep this manual for future reference.
- Do not leave plastic bags within the reach of children. Risk of suffocation.
- Unpack the mattress in a well-ventilated room.
- Allow 72 hours for decompression before use.
- Place the mattress on a clean, flat surface.
- Ensure the mattress is properly positioned on the recommended support.
- Do not place the mattress near an open flame or heat source.

Deutsch (DE)

Lesen Sie diese Anleitung sorgfältig durch, bevor Sie die Matratze verwenden.

- Bewahren Sie diese Anleitung für zukünftige Referenz auf.
- Plastiktüten nicht in Reichweite von Kindern lassen. Erstickungsgefahr.
- Packen Sie die Matratze in einem gut belüfteten Raum aus.
- Lassen Sie die Matratze 72 Stunden zur Entfaltung ruhen, bevor Sie sie verwenden.
- Legen Sie die Matratze auf eine saubere, ebene Fläche.
- Stellen Sie sicher, dass die Matratze korrekt auf der empfohlenen Unterlage positioniert ist.
- Platzieren Sie die Matratze nicht in der Nähe von offenen Flammen oder Wärmequellen.

Italiano (IT)

Leggere attentamente queste istruzioni prima di utilizzare il materasso.

- Conservare queste istruzioni per riferimento futuro.
- Non lasciare i sacchetti di plastica alla portata dei bambini. Rischio di soffocamento.
- Disimballare il materasso in una stanza ben ventilata.
- Attendere 72 ore per la decompressione prima dell'uso.
- Posizionare il materasso su una superficie piana e pulita.
- Assicurarsi che il materasso sia correttamente posizionato sul supporto raccomandato.
- Non posizionare il materasso vicino a fiamme libere o fonti di calore.

Español (ES)

Lea atentamente este manual antes de usar el colchón.

- Conserve este manual para futuras consultas.
- No deje bolsas de plástico al alcance de los niños. Riesgo de asfixia.
- Desempaque el colchón en una habitación bien ventilada.
- Espere 72 horas para que el colchón se descomprima antes de usarlo.
- Coloque el colchón sobre una superficie limpia y plana.
- Asegúrese de que el colchón esté correctamente colocado sobre el soporte recomendado.

- No coloque el colchón cerca de llamas abiertas o fuentes de calor.
-

Português (PT)

Leia atentamente este manual antes de usar o colchão.

- Guarde este manual para referência futura.
 - Não deixe sacos plásticos ao alcance de crianças. Risco de asfixia.
 - Desembale o colchão em um local bem ventilado.
 - Aguarde 72 horas para a descompressão antes de usar.
 - Coloque o colchão sobre uma superfície limpa e plana.
 - Certifique-se de que o colchão esteja corretamente posicionado no suporte recomendado.
 - Não coloque o colchão próximo a chamas abertas ou fontes de calor.
-

Polski (PL)

Przeczytaj uważnie tę instrukcję przed użyciem materaca.

- Zachowaj tę instrukcję na przyszłość.
 - Nie pozostawiaj plastikowych toreb w zasięgu dzieci. Ryzyko uduszenia.
 - Rozpakuj materac w dobrze wentylowanym pomieszczeniu.
 - Odczekaj 72 godziny na pełne rozłożenie przed użyciem.
 - Umieść materac na czystej i płaskiej powierzchni.
 - Upewnij się, że materac jest prawidłowo umieszczony na zalecanym podparciu.
 - Nie umieszczaj materaca w pobliżu otwartego ognia ani źródeł ciepła.
-

Nederlands (NL)

Lees deze handleiding zorgvuldig door voordat u de matras gebruikt.

- Bewaar deze handleiding voor toekomstig gebruik.
- Laat plastic zakken niet binnen het bereik van kinderen. Verstikkingsgevaar.
- Pak de matras uit in een goed geventileerde ruimte.
- Laat de matras 72 uur decomprimeren voordat u deze gebruikt.
- Leg de matras op een schone, vlakke ondergrond.
- Zorg ervoor dat de matras correct is geplaatst op het aanbevolen ondersteuningssysteem.
- Plaats de matras niet in de buurt van een open vlam of warmtebron.



Vente-unique.com

VS-Jul-2024

Imported by - Importé par

CAFOM DISTRIBUTION

9 Rue Jacquart 93310 Le Pré-Saint-Gervais

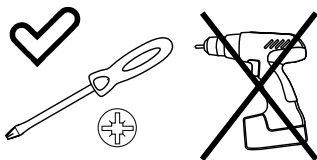
DEKIT®**K452** v.09**5 h.**

ES La cama superior no es adecuada para niños menores de seis años, debido al riesgo de lesiones por caídas.

EN The top bed is not suitable for children under six years of age due to the risk of injury from falls.

FR Le lit supérieur ne convient pas aux enfants de moins de six ans en raison du risque de blessure en cas de chute.

PT A cama de cima não é adequada para crianças com menos de seis anos devido ao risco de lesões por quedas.

IT Il letto superiore non è adatto ai bambini di età inferiore ai sei anni a causa del rischio di lesioni dovute a cadute.

DE Für Kinder unter sechs Jahren ist das Oberbett wegen Verletzungsgefahr durch Stürze nicht geeignet.

NL Het bovenste bed is niet geschikt voor kinderen jonger dan zes jaar vanwege het risico op letsel bij vallen.

PL Górne łóżko nie jest odpowiednie dla dzieci poniżej szóstego roku życia ze względu na ryzyko obrażeń na skutek upadku.

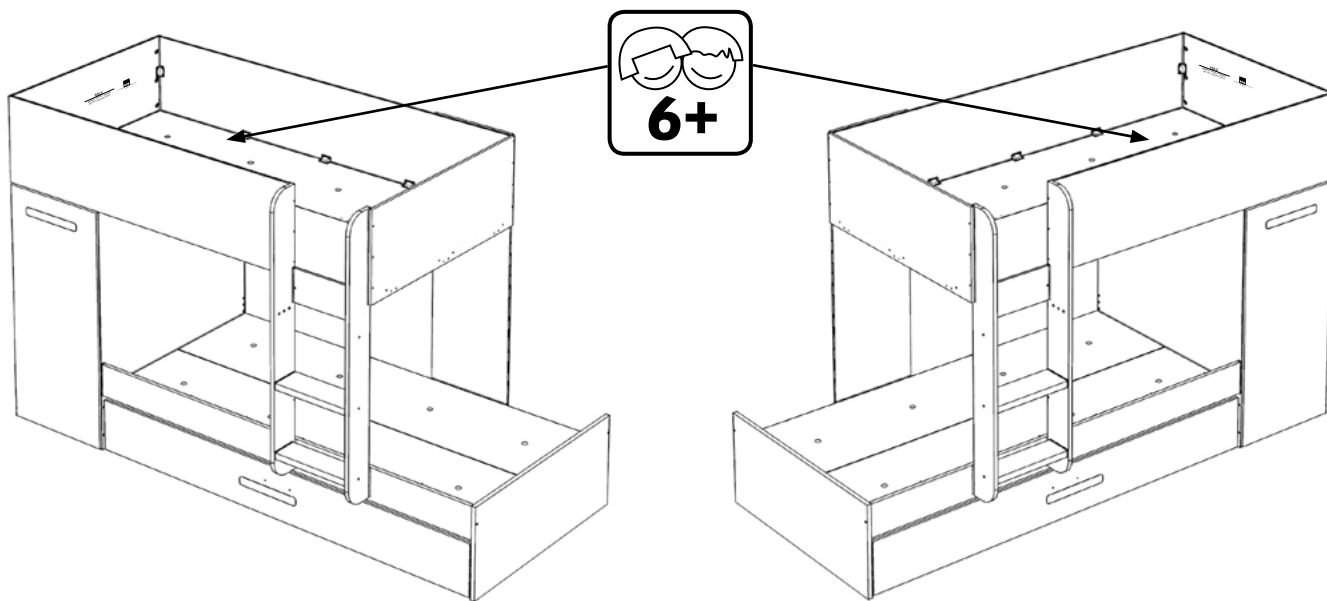

**MATTRESS: 90x190 cm.
H Max. 19 cm.**

ES

**RECOMENDACIONES
MONTAJE Y USO**

Agrupe y cuente el herraje.
Prepare todas las piezas para el montaje del mueble.
Tenga preparadas las herramientas para el montaje.
Prepare la zona del montaje.
Monte el mueble sobre una moqueta para evitar rayar y dañar la superficie del mueble.
No fuerce los ensamblajes.
Evite colocar el mueble cerca de fuentes de calor.
Evite utilizar trapos, paños o productos de limpieza que puedan dañar la superficie del mueble.
Mueble para uso doméstico en interior de vivienda.

EN

**RECOMMENDATIONS
FOR ASSEMBLY AND USE**

Prepare all the parts of the furniture
Group and count all the hardware
Prepare all the tools for the assembly.
Clear and prepare the assembly area.
Do the assembly on a carpet to avoid damaging the surface of the furniture
Avoid forcing the fittings
Avoid placing the Furniture near any heating source
Do not use cloths or cleaning products to avoid damaging the surface of the furniture
Indoor furniture. Suitable for domestic use.

FR

**CONSEILS DE MONTAGE
CONSEILS POUR L'USAGE**

Préparez les différents parts du meuble
Regrouper et compter toute la quincaillerie
Préparez l'outillage nécessaire
Aménagez-vous une area de montage
Faire le montage sur moquette afin de protéger le meuble des rayures
Ne forcer pas le montage
Évitez placer le meuble près des sources de chaleur
Évitez utiliser de chiffons ou des produits de nettoyage pour ne pas rayer la superficie du meuble
Meuble d'usage domestique pour l'intérieur de la maison.

PT

**RECOMENDAÇÕES
PARA MONTAGEM E USO**

Prepare todas as peças para a montagem de móveis
Reagrupar e contar o hardware
Preparar as ferramentas de montagem
Preparar a área de montagem
Montar as peças em tapete para evitar riscos e danos nasuperfície dos móveis
Não force as assembleias
Não colocar móveis perto de fontes de calor
Evitar o uso de panos, trapos ou produtos de limpeza que possam riscar o móvel.
Móveis para uso doméstico no interior da casa.

IT

CONSIGLI INSTALLAZIONE ED USO

Preparare tutti componenti del mobile per il montaggio
Ordinare la ferramenta
Preparare tutti gli attrezzi necessari per il montaggio
Preparare l'area di montaggio
Fare il montaggio su un tappeto per evitare danneggiare le superfici dei mobili
Non forzare i componenti
Evitare posizionare il mobile in prossimità di fonti di calore
Non usare panni né detersivi né solventi che possano danneggiare le superfici dei mobili
Mobili per uso domestico all'interno della casa.

DE

MONTAGEHINWEISE-GEBRAUCHSHINWEISE

Identifizieren Sie die Einzelteile
Überprüfen Sie Die Anzahl der einzelnen Beschlagteile
Legen Sie das notwendige Werkzeug bereit
Bereiten die Montagefläche
Montieren Sie das Möbel auf einem Teppich , sauberen Untergrund
Niemals die verbindungen zu start anziehen
Nicht neben Wärmequellen platzieren
Vermeiden Sie Tücher und keinesfalls scharfe oder ätzende Reinigungsmittel.
Möbel für den Gebrauch im Haus geeignet.

NL

**AANBEVELINGEN
MONTAGE EN GEBRUIK**

Groep en tel de hardware.
Maak alle stukken klaar voor het monteren van het meubilair.
Bereid alle gereedschappen voor de montage voor.
Maak het montagegebied schoon en bereid het voor.
Monteer het meubel op een tapijt om krassen te voorkomen en het oppervlak van het meubilair te beschadigen.
Forceer de montage niet.
Plaats het meubilair niet in de buurt van warmtebronnen.
Vermijd het gebruik van vossen, doeken of schoonmaakmiddelen die het oppervlak van het meubilair kunnen beschadigen.
Meubilair voor huishoudelijk gebruik binnenshuis.

PL

**ZALECENIA
MONTAŻ I UŻYTKOWANIE**

Grupuj i policz sprzęt.
Przygotuj wszystkie elementy do montażu mebli.
Przygotuj narzędzia do montażu.
Przygotuj miejsce montażu.
Zamontuj meble na dywanie, aby uniknąć zarysowań i uszkodzeń powierzchni mebli.
Nie wymuszaj montażu.
Unikaj umieszczania mebli w pobliżu źródeł ciepła.
Unikaj używania szmat, ściereczek i środków czyszczących które mogą uszkodzić powierzchnię mebla.
Meble do użytku domowego w domu.

ES

IMPORTANTE. LEA LAS INSTRUCCIONES DETENIDAMENTE Y CONSÉRVELAS PARA CONSULTAS POSTERIORES.

ADVERTENCIAS:

1. Las camas altas y la cama superior de las literas, no son adecuadas para niños menores de seis años, debido al riesgo de lesiones por caídas.
2. Las literas y las camas altas pueden presentar un riesgo grave de estrangulamiento, si no se utilizan correctamente. No se debe sujetar o colgar en ninguna parte de la litera, ningún elemento que no esté diseñado para utilizarlo con la cama. Por ejemplo (pero pueden haber otros): cuerdas, cordeles, cordones, ganchos, correas y bolsas.
3. Los niños pueden quedar atrapados entre la cama y la pared, el techo, el tejado, otros elementos de muebles adyacentes (por ejemplo, armarios) y similares. Para evitar el riesgo de lesiones graves, la distancia entre la barrera de seguridad superior y la estructura adyacente, no debe ser superior a 75 mm, o debe ser mayor de 230 mm.
4. No utilizar la litera o la cama alta si alguno de sus componentes estructurales está roto o falta.

INFORMACIÓN:

- Seguir siempre las instrucciones del fabricante.
- El espesor máximo del colchón debe ser **19 cm**.
- Tamaño de colchón debe ser **90x190 cm**.

INDICACIONES:

- La habitación debe estar ventilada para mantener una humedad baja e impedir la formación de moho en la cama y sus alrededores.
- Revisar periódicamente que todos los elementos de fijación estén correctamente ajustados.

Este mueble cumple con los requisitos de la Norma EN 747-1:2024

EN

IMPORTANT. PLEASE READ THE INSTRUCTIONS CAREFULLY AND KEEP THEM FOR FUTURE REFERENCE.

WARNINGS :

1. Loft beds and upper bunks are not suitable for children under the age of six, due to the risk of injury from falls.
2. Bunk beds and high beds can present a serious risk of strangulation if not used correctly. Any item not designed for use with the bed should not be placed or hung anywhere on the bunk bed. For example (but there may be others): ropes, laces, laces, hooks, straps, and bags.
3. Children can become trapped between the bed and the wall, the ceiling, the ceiling, other adjacent furniture elements (for example, cabinets) and the like. To avoid the risk of serious injury, the distance between the upper safety barrier and the adjacent structure must not exceed 75 mm and must not be more than 230 mm.
4. Do not use the bunk bed or high bed if any of its structural components is broken or missing.

INFORMATION :

- Always follow the manufacturer's instructions.
- The maximum thickness of the mattress must be **19 cm**.
- Mattress size must be **90x190 cm**.

INDICATIONS :

- The room should be ventilated to maintain low humidity and prevent mold growth in and around the bed.
- Periodically check that all fasteners are properly tightened.

This furniture complies with the requirements of EN 747-1:2024

FR

IMPORTANT. LISEZ ATTENTIVEMENT LES INSTRUCTIONS ET CONSERVEZ-LES POUR VOUS Y RÉFÉRER ULTÉRIEUREMENT.

AVERTISSEMENTS :

1. Les lits hauts et les lits superposés supérieurs ne conviennent pas aux enfants de moins de six ans, en raison du risque de blessures dues à des chutes.
2. Les lits hauts et les lits superposés peuvent présenter un risque sérieux de strangulation s'ils ne sont pas utilisés correctement. Rien ne doit être attaché ou accroché sur la couchette qui n'est pas conçu pour être utilisé avec le lit. Par exemple (mais il peut y en avoir d'autres) : cordes, ficelles, cordages, crochets, sangles et sacs.
3. Les enfants peuvent être coincés entre le lit et le mur, le plafond, le toit, d'autres meubles adjacents (par exemple les placards) et autres. Pour éviter le risque de blessure grave, la distance entre la barrière de sécurité supérieure et la structure adjacente ne doit pas dépasser 75 mm, ou doit être supérieure à 230 mm.
4. N'utilisez pas la couchette ou le lit haut si l'un de ses éléments structurels est cassé ou manquant.

INFORMATION :

- Suivez toujours les instructions du fabricant.
- L'épaisseur maximale du matelas doit être de **19 cm**.
- La taille du matelas doit être de **90x190 cm**.

INDICATIONS :

- La pièce doit être ventilée pour maintenir un faible taux d'humidité et empêcher la formation de moisissures dans et autour du lit.
- Vérifiez périodiquement que tous les éléments de fixation sont correctement réglés.

Ce mobilier est conforme aux exigences de la norme EN 747-1:2024

PT

IMPORTANTE LEIA AS INSTRUÇÕES COM ATENÇÃO E MANTENHA-AS PARA FUTURA REFERÊNCIA.

ADVERTÊNCIAS:

1. Camas altas e beliches superiores não são adequados para crianças menores de seis anos, devido ao risco de lesões por quedas.
2. Beliches e camas altas podem apresentar um sério risco de estrangulamento se não forem usadas corretamente. Qualquer item não projetado para uso com a cama não deve ser colocado ou pendurado em nenhum lugar do beliche. Por exemplo (mas pode haver outros): cordas, cordões, cordões, ganchos, correias e bolsas.
3. As crianças podem ficar presas entre a cama e a parede, o teto, o teto, outros elementos de móveis adjacentes (por exemplo, armários) e similares. Para evitar o risco de ferimentos graves, a distância entre a barreira de segurança superior e a estrutura adjacente não deve exceder 75 mm ou 230 mm.
4. Não use a cama de beliche ou a cama alta se algum de seus componentes estruturais estiver quebrado ou ausente.

INFO:

- Sempre siga as instruções do fabricante.
- A espessura máxima do colchão deve ser de **19 cm**.
- O tamanho do colchão deve ser de **90x190 cm**.

INDICAÇÕES:

- A sala deve ser ventilada para manter a umidade baixa e impedir o crescimento de fungos dentro e ao redor da cama.
- Periodicamente, verifique se todos os parafusos estão bem apertados.

Este móvel está em conformidade com os requisitos da EN 747-1:2024

IT

IMPORTANTE. LEGGERE ATTENTAMENTE LE ISTRUZIONI E CONSERVARLE PER RIFERIMENTO FUTURO.

1. I letti a soppalco e i letti alti non sono adatti ai bambini di età inferiore ai sei anni, a causa del rischio di lesioni dovute a cadute.
2. I letti a castello e i letti alti possono presentare un grave rischio di strangolamento se non utilizzati correttamente. Qualsiasi oggetto non progettato per l'uso con il letto non deve essere collocato o appeso in nessun punto del letto a castello. Ad esempio (ma potrebbero essercene altri): corde, lacci, laccioli, ganci, cinghie e borse.
3. I bambini possono rimanere intrappolati tra il letto e la parete, il soffitto, il controsoffitto, altri elementi di arredo adiacenti (ad esempio, armadi) e simili. Per evitare il rischio di lesioni gravi, la distanza tra la barriera di sicurezza superiore e la struttura adiacente non deve superare i 75 mm e non deve essere superiore a 230 mm.
4. Non utilizzare il letto a castello o il letto alto se uno dei suoi componenti strutturali è rotto o mancante.

INFO:

- Seguire sempre le istruzioni del produttore.
- Lo spessore massimo del materasso deve essere di **19 cm**.
- Le dimensioni del materasso devono essere **90x190 cm**.

INDICAZIONI :

- La stanza deve essere ventilata per mantenere una bassa umidità e prevenire la formazione di muffa all'interno e intorno al letto.
- Controllare periodicamente che tutti gli elementi di fissaggio siano ben serrati.

Questo mobile è conforme ai requisiti della norma EN 747-1:2024

DE

WICHTIG BITTE LESEN SIE DIE ANWEISUNGEN SORGFÄLTIG DURCH UND BEWAHREN SIE SIE FÜR ZUKÜNFTIGE REFERENZEN AUF.

WARNHINWEISE:

1. Hochbetten und obere Kojen sind wegen des Verletzungsrisikos durch Stürze nicht für Kinder unter sechs Jahren geeignet.
2. Etagenbetten und Hochbetten können bei Missbrauch ein ernstes Strangulationsrisiko darstellen. Gegenstände, die nicht für die Verwendung mit dem Bett vorgesehen sind, dürfen nicht an der Koje befestigt oder an einer anderen Stelle der Koje aufgehängt werden. Zum Beispiel (aber es kann auch andere geben): Seile, Schnürsenkel, Schnürsenkel, Haken, Gurte und Taschen.
3. Kinder können zwischen dem Bett und der Wand, der Decke, der Decke, anderen angrenzenden Möbelementen (z. B. Schränken) und dergleichen eingeklemmt werden. Um das Risiko schwerer Verletzungen zu vermeiden, darf der Abstand zwischen der oberen Sicherheitsbarriere und der angrenzenden Struktur 75 mm und 230 mm nicht überschreiten.
4. Verwenden Sie das Etagenbett oder Hochbett nicht, wenn eines der Bauteile beschädigt ist oder fehlt.

INFO:

- Befolgen Sie immer die Anweisungen des Herstellers.
- Die maximale Dicke der Matratze muss **19 cm** betragen.
- Die Matratzengröße muss **90x190 cm** betragen.

INDIKATIONEN:

- Der Raum sollte belüftet werden, um die Luftfeuchtigkeit niedrig zu halten und zu verhindern, dass sich Schimmel im und um das Bett bildet.
- Überprüfen Sie regelmäßig, ob alle Befestigungselemente ordnungsgemäß konfiguriert sind.

Dieses Möbel entspricht den Anforderungen der EN 747-1:2024

NL**BELANGRIJK LEES DE INSTRUCTIES ZORGVULDIG EN BEWAAR VOOR TOEKOMSTIGE REFERENTIE.****WAARSCHUWINGEN:**

1. Hoogslapers en stapelbedden zijn niet geschikt voor kinderen onder de zes jaar vanwege het risico op verwondingen door vallen.
2. Stapelbedden en hoogslapers kunnen bij misbruik een ernstig risico op verwurging opleveren. Elk item dat niet is ontworpen voor gebruik met het bed mag niet worden bevestigd aan of opgehangen aan enig deel van het stapelbed. Bijvoorbeeld (maar er kunnen er meer zijn): touwen, veters, veters, haken, riemen en tassen.
3. Kinderen kunnen bekneld raken tussen het bed en de muur, het plafond, het plafond, andere aangrenzende meubelelementen (bijvoorbeeld kasten) en dergelijke. Om het risico op ernstig letsel te voorkomen, mag de afstand tussen de bovenste veiligheidsbarrière en de aangrenzende constructie niet groter zijn dan 75 mm of meer dan 230 mm.
4. Gebruik het stapelbed of het hoge stapelbed niet als een van de structurele componenten kapot is of ontbreekt.

INFO:

- Volg altijd de instructies van de fabrikant.
- De maximale dikte van de matras kan **19 cm** zijn.
- De afmeting van de matras moet **90x190 cm** zijn.

INDICATIES:

- De kamer moet worden geventileerd om een lage luchtvochtigheid te behouden en schimmelgroei in en rond het bed te voorkomen.
- Controleer regelmatig of alle bevestigingen goed zijn vastgedraaid.

Dit meubilair voldoet aan de eisen van EN 747-1:2024

PL**WAŻNE. NALEŻY UWAŻNIE PRZECZYTAĆ INSTRUKCJE I ZACHOWAĆ JE NA PRZYSZŁOŚĆ.****OSTRZEŻENIA :**

1. Łóżka na poddaszu i górne łóżka piętrowe nie są odpowiednie dla dzieci poniżej szóstego roku życia ze względu na ryzyko obrażeń spowodowanych upadkiem.
2. Łóżka piętrowe i wysokie łóżka mogą stwarzać poważne ryzyko uduszenia, jeśli nie są używane prawidłowo. Na łóżku piętrowym nie należy umieszczać ani wieszać żadnych przedmiotów nieprzeznaczonych do użytku z tym łóżkiem. Na przykład (ale mogą być też inne): liny, sznurowadła, haczyki, paski i torby.
3. Dzieci mogą zostać uwięzione między łóżkiem a ścianą, sufitem, innymi sąsiednimi elementami mebli (na przykład szafkami) itp. Aby uniknąć ryzyka poważnych obrażeń, odległość między górną barierką zabezpieczającą a sąsiednią konstrukcją nie może przekraczać 75 mm i nie może być większa niż 230 mm.
4. Nie używaj łóżka piętrowego lub wysokiego, jeśli którykolwiek z jego elementów konstrukcyjnych jest uszkodzony lub go brakuje

INFO:

- Należy zawsze przestrzegać instrukcji producenta.
- Maksymalna grubość materaca musi wynosić **19 cm**.
- Rozmiar materaca musi wynosić **90x190 cm**.

WSKAZANIA :

- Pomieszczenie powinno być wentylowane, aby utrzymać niską wilgotność i zapobiec rozwojowi pleśni w łóżku i wokół niego.
- Należy okresowo sprawdzać, czy wszystkie elementy mocujące są prawidłowo dokręcone.

Ten mebel spełnia wymagania normy EN 747-1:2024

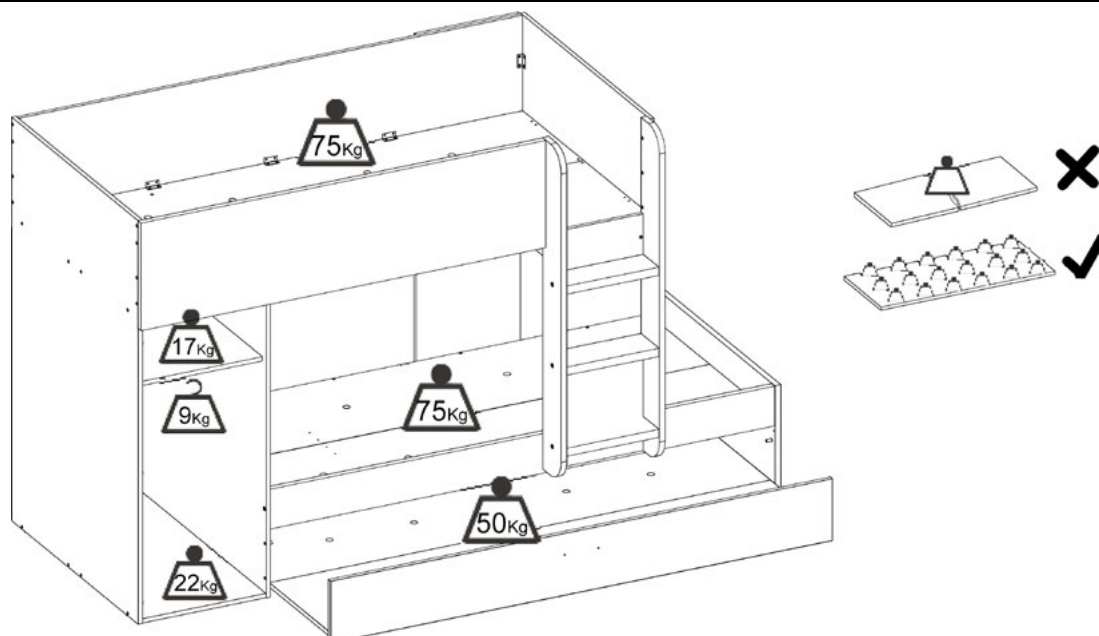

	A x 03 	B x 03 	E x 15 	F x 15 	G x 76 3.5 x 15 mm.	H x 43 4 x 16 mm.	I x 04 4 x 27 mm.
J x 04 4 x 30 mm.	K x 30 M4 x 10 mm.	L x 05 M4 x 15 mm.	M x 30 M4 x 15 mm.	N x 05 M4 x 29 mm.	Ñ x 40 5 x 60 mm.	Q x 08 M6 x 60 mm.	R x 07
S x 02 13 mm.	T x 06 21 mm.	V x 30 	W x 02 	Y x 03 	Z x 18 	AA x 02 	AB x 06
AC x 03 	AD x 06 	AE x 06 	AF x 02 	AG x 11 	AI x 01 Nº 3	AJ x 01 Nº 4	AM x 07 4 x 20 mm.



	C x 24 	D x 12 10 x 70 mm.	U x 02 	AK x 52 17 mm.	AL x 02 7 mm.
--	------------	---------------------------	------------	-----------------------	----------------------



AH x 08

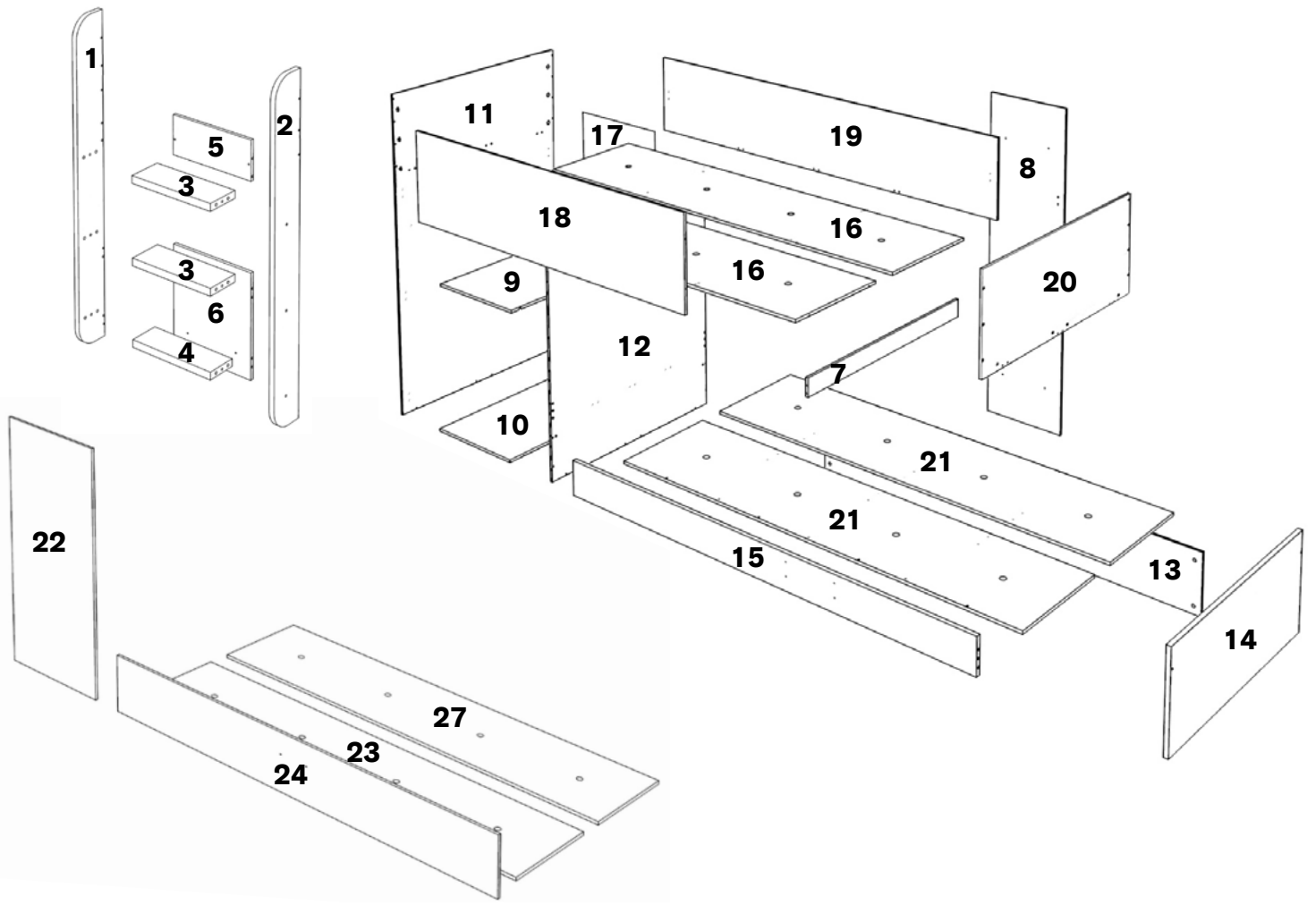

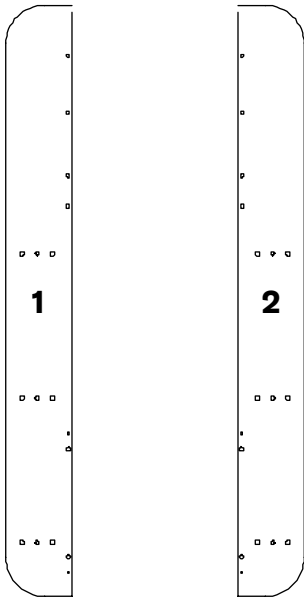

1

2

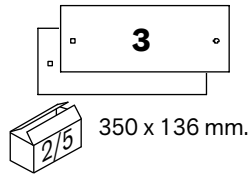

3

350 x 136 mm.

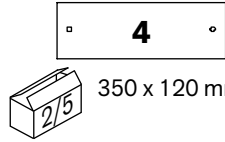

4

350 x 120 mm.

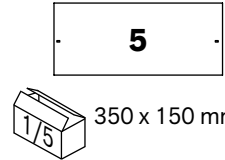

5

350 x 150 mm.

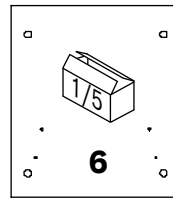

6

396 x 350 mm.

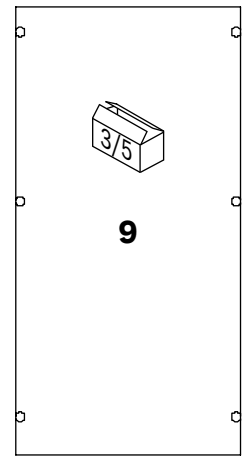

9

930 x 468 mm.

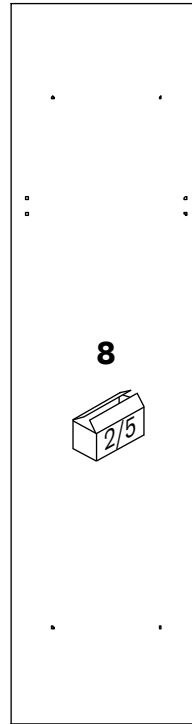

8

1492 x 394 mm.

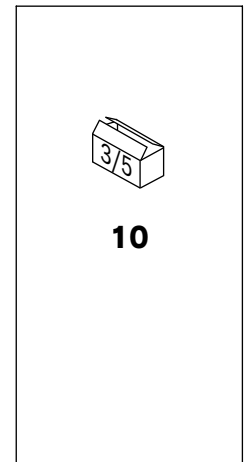

10

956 x 468 mm.

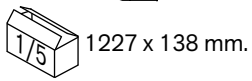

1227 x 138 mm.

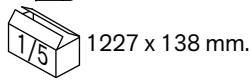

1227 x 138 mm.

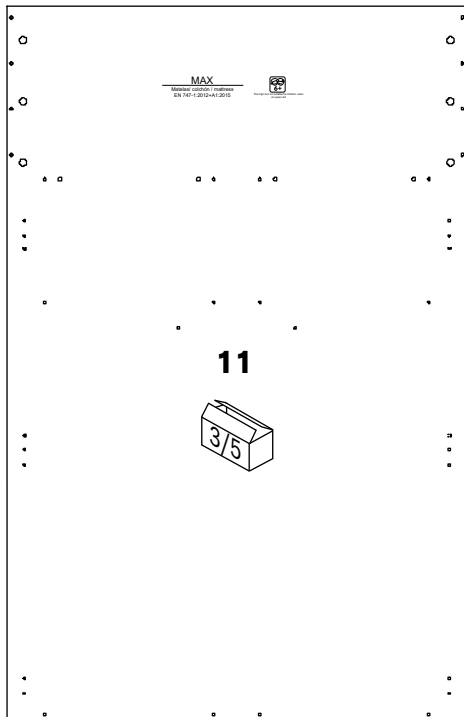

11

1494 x 958 mm.



7

958 x 90 mm.



8



8



10

10



11

11

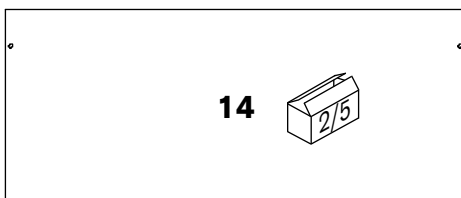

14

958 x 401 mm.

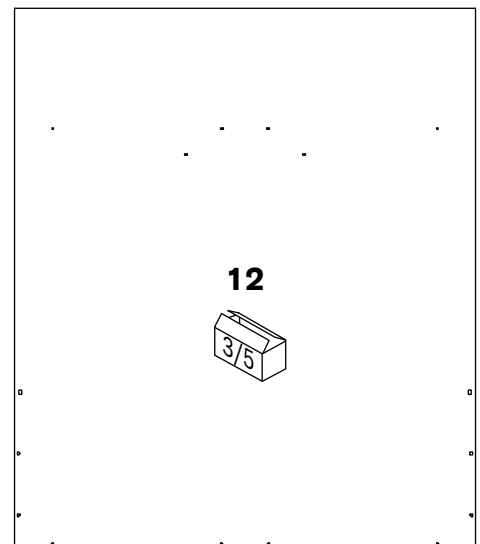

12

1124 x 958 mm.

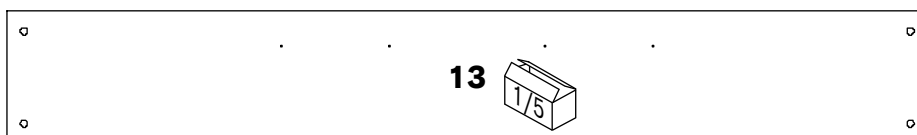

13

1910 x 268 mm.



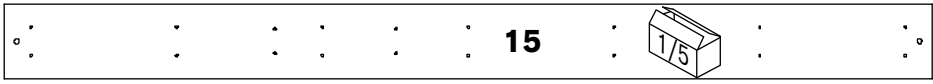

1910 x 148 mm.

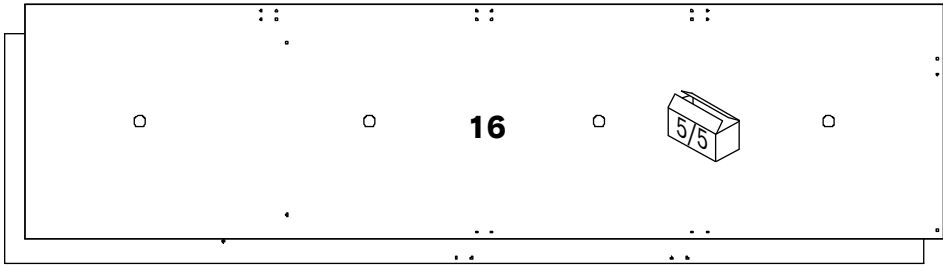

1910 x 479 mm.

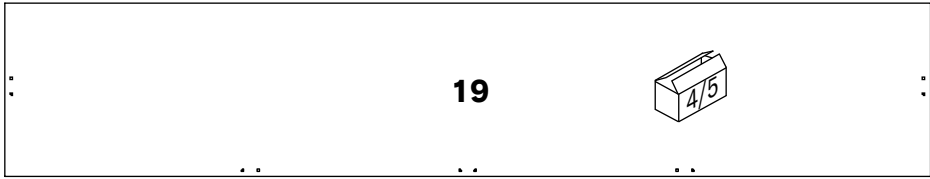

1910 x 353 mm.

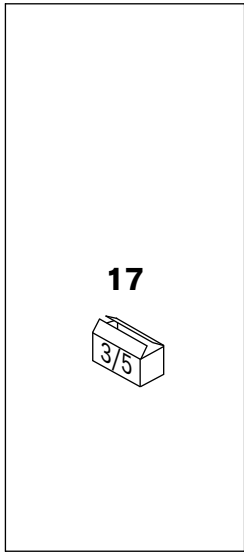

1083 x 498 mm.

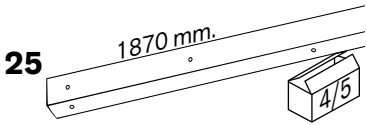

1870 mm.

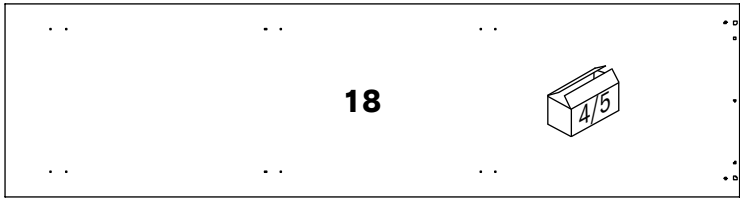

1533 x 398 mm.

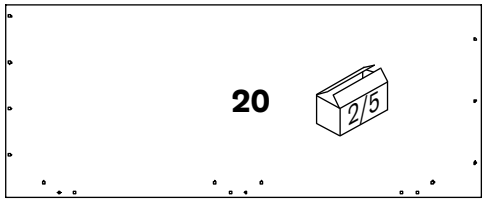

978 x 400 mm.

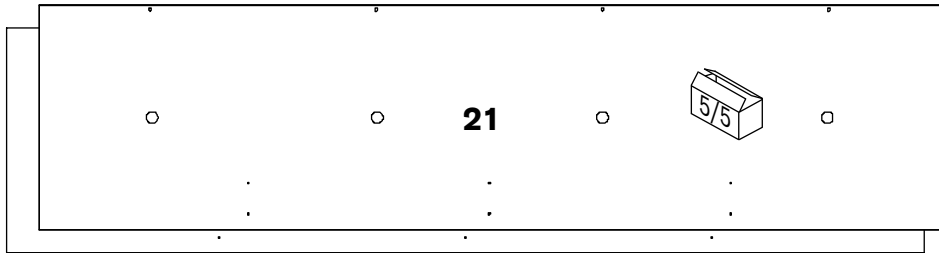

1908 x 466 mm.

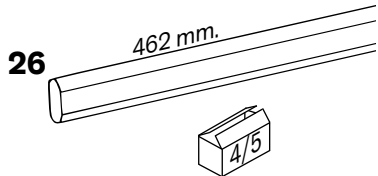

462 mm.

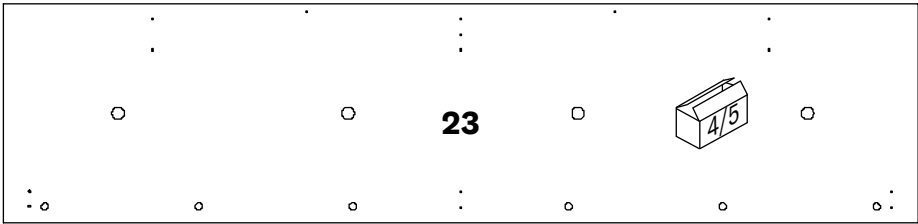

1898 x 450 mm.

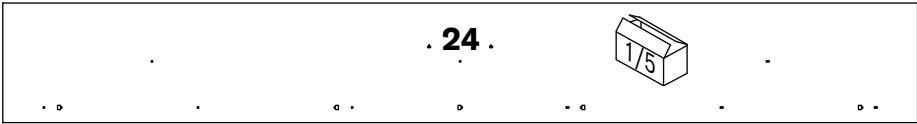

1900 x 230 mm.

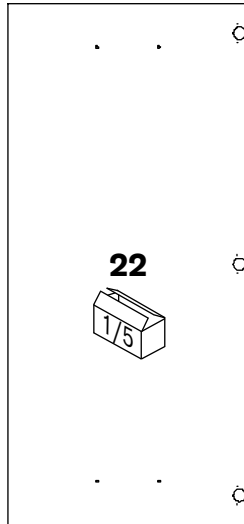

1076 x 498 mm.

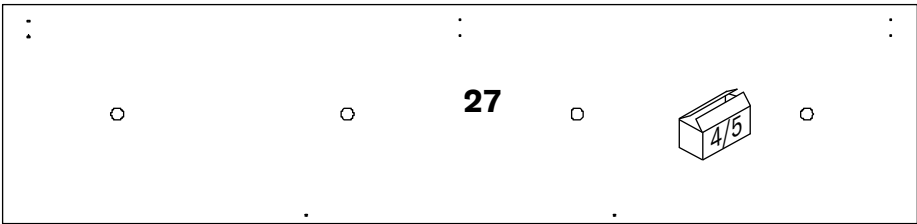

1898 x 450 mm.

1

E x 02

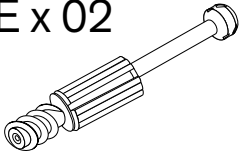

D x 06

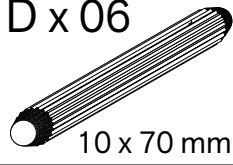

10 x 70 mm.

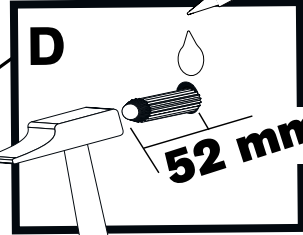

52 mm.

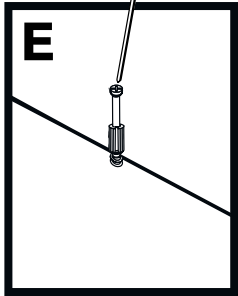
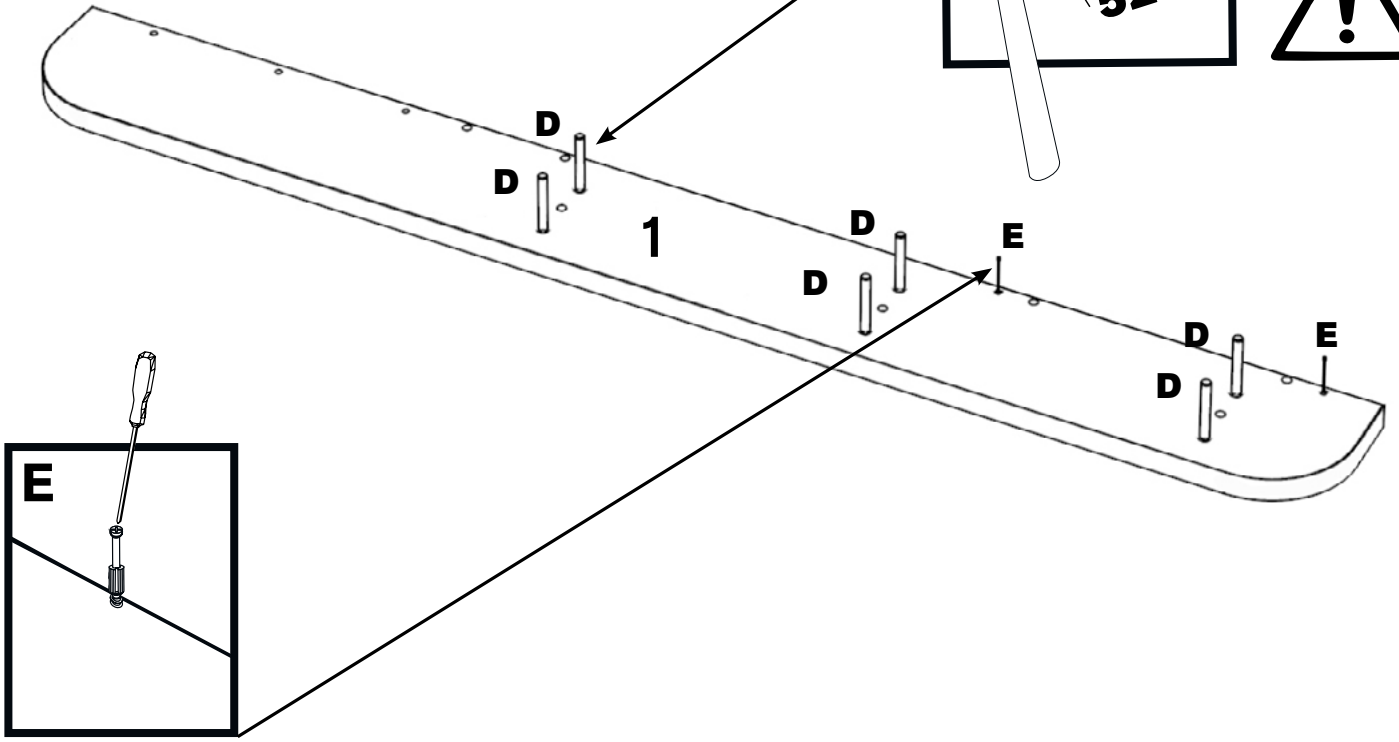

2

E x 02

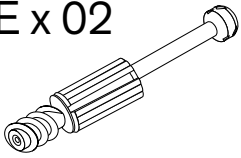

D x 06

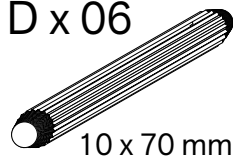

10 x 70 mm.

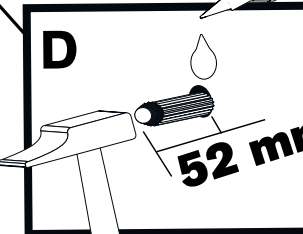

52 mm.

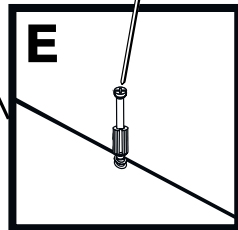
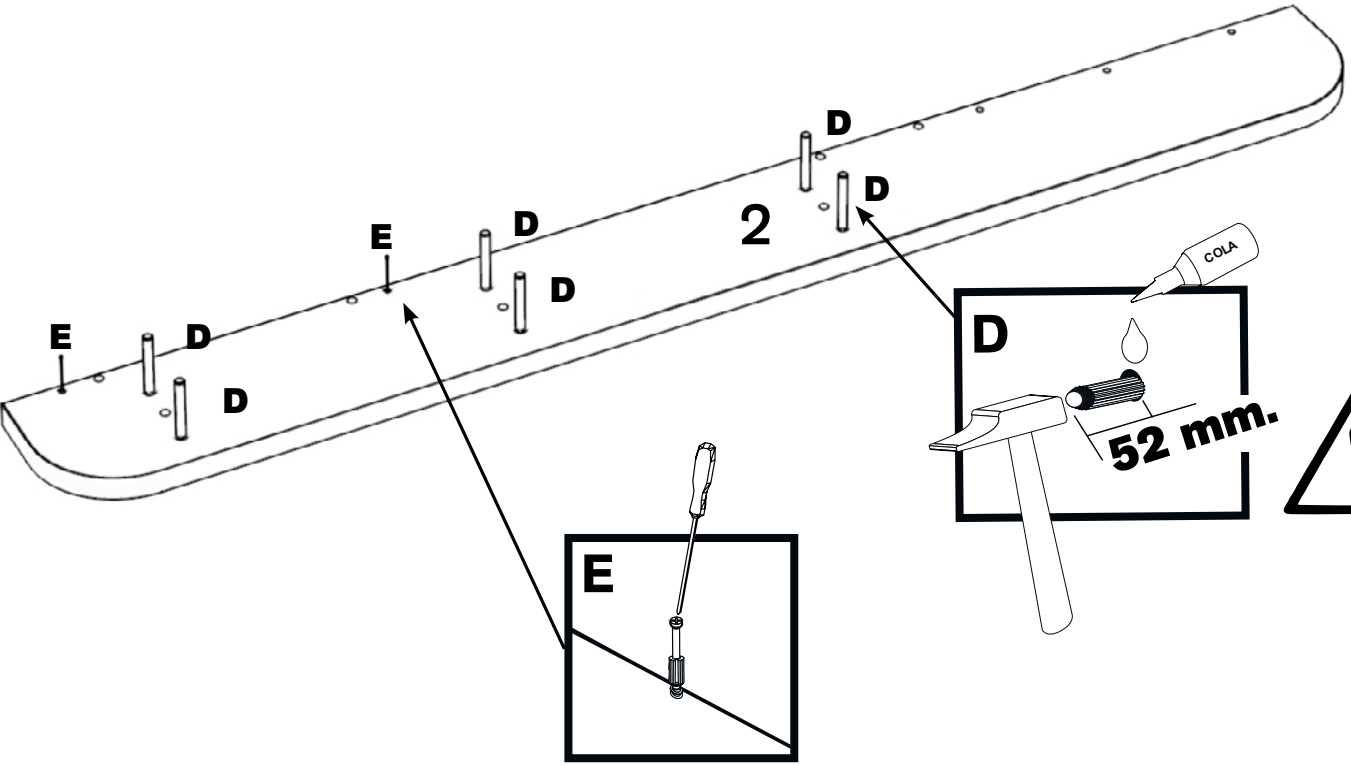

3 T x 04

21 mm.

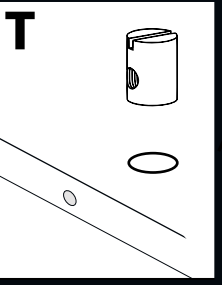
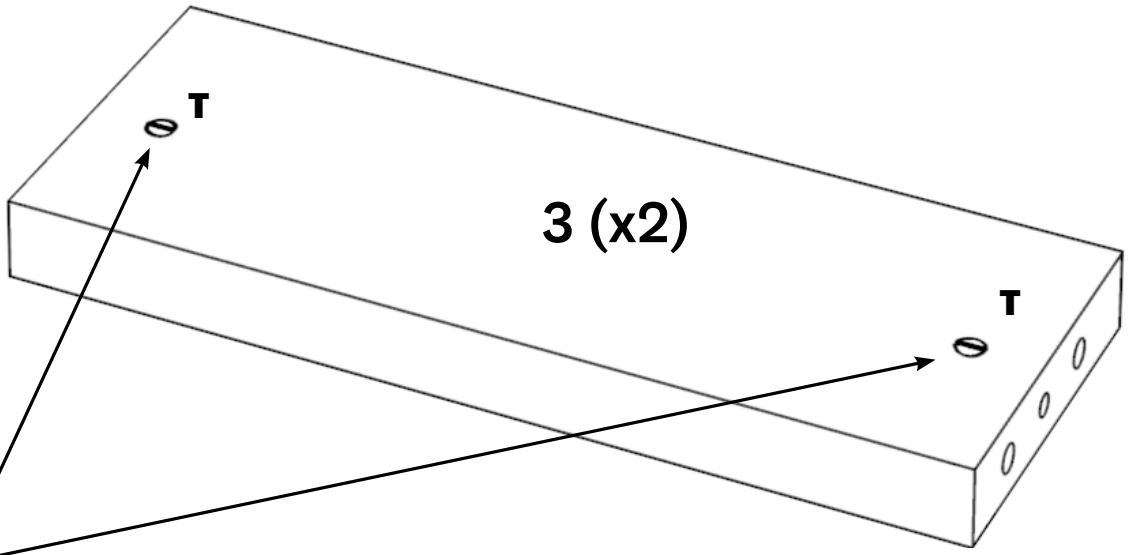
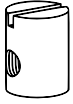

4 T x 02

21 mm.

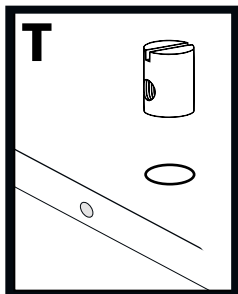
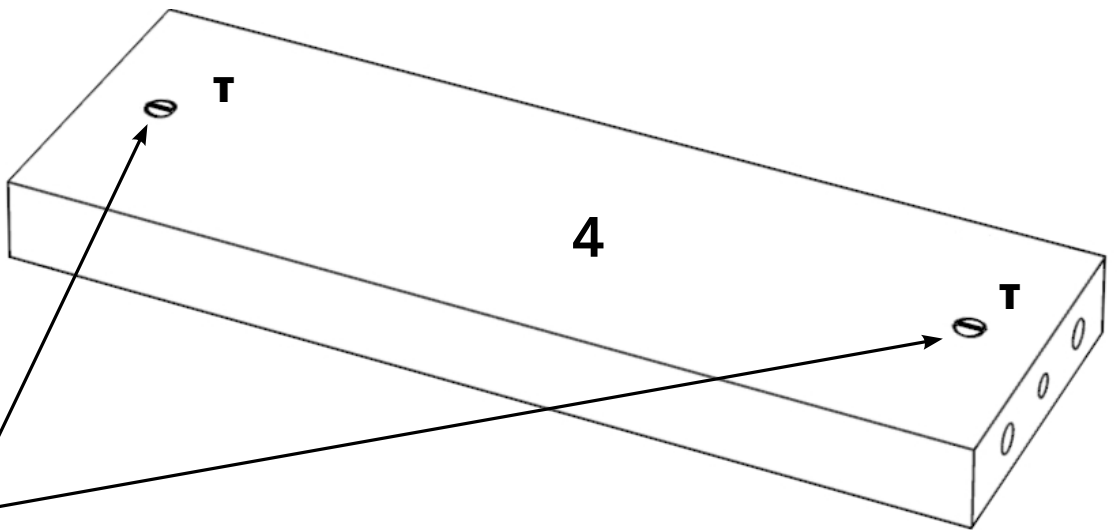
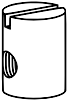

5 C x 04

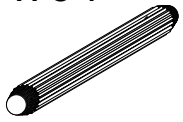

G x 02



3.5 x 15 mm.

Z x 01

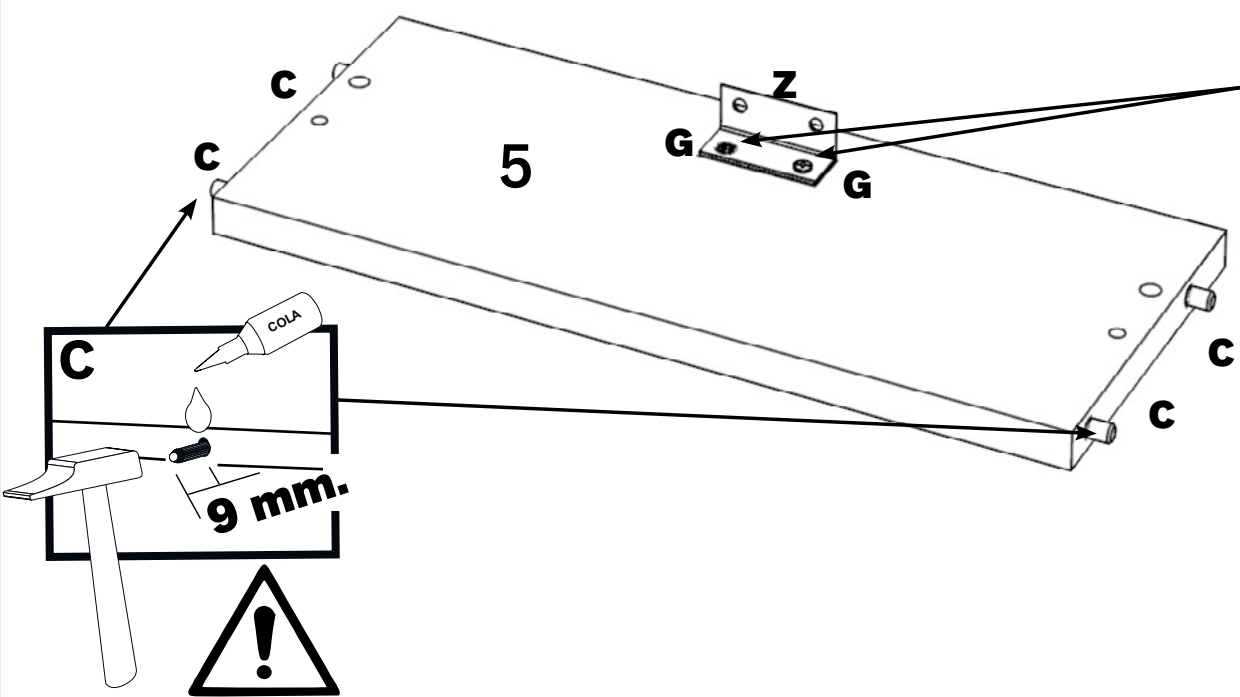
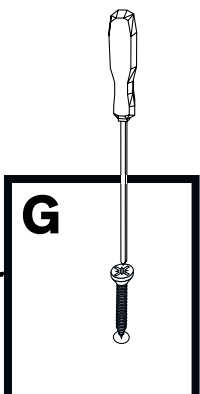
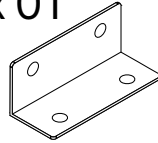

6 C x 04

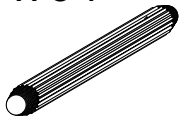

F x 04

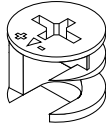

G x 02



3.5 x 15 mm.

Y x 02

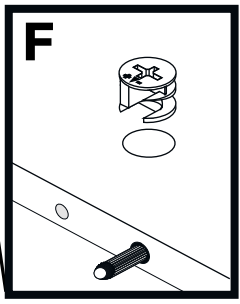
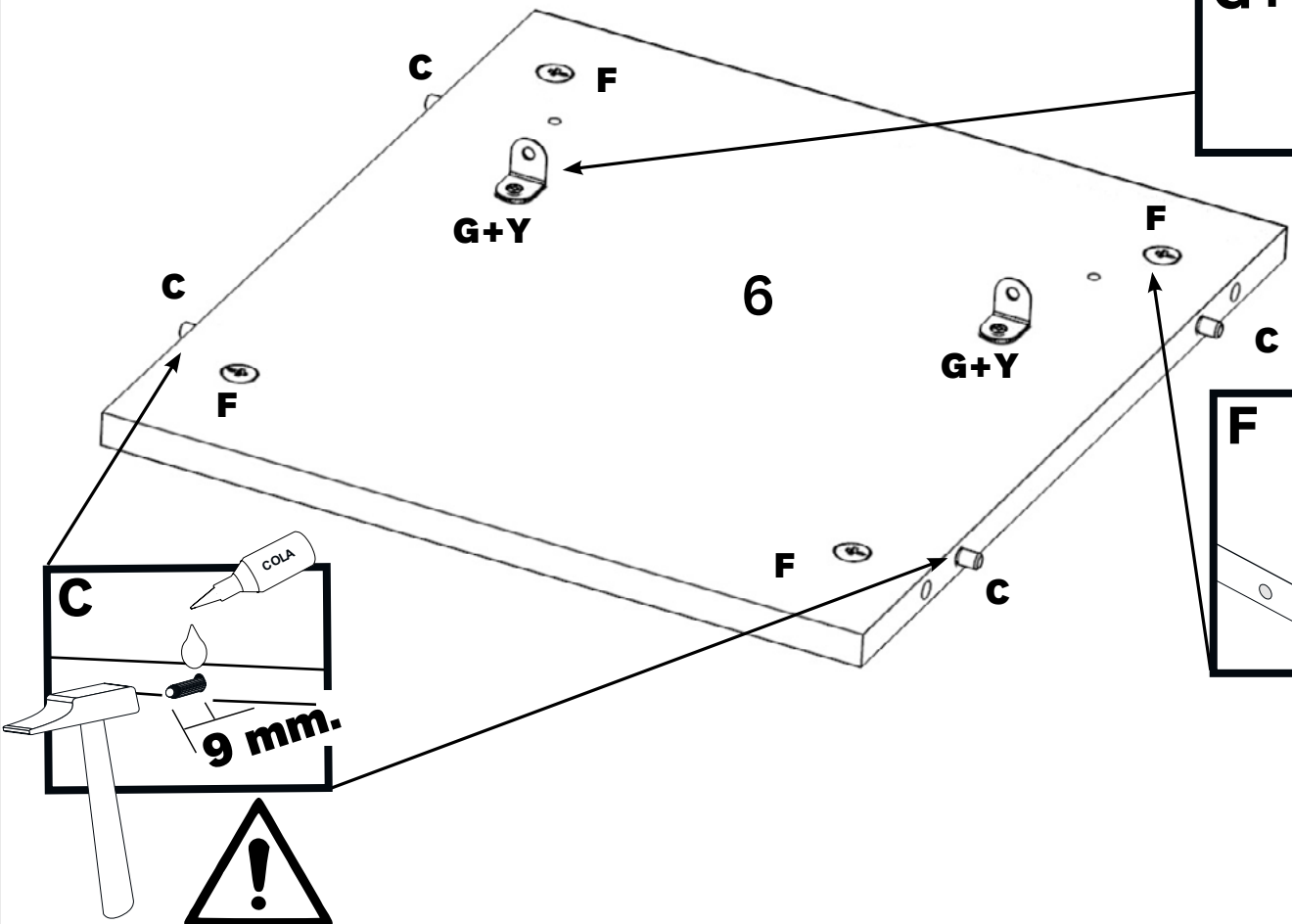
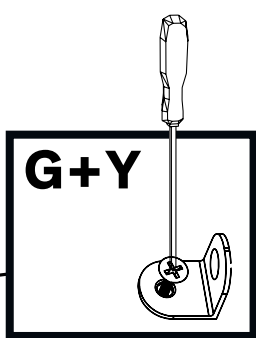

7 Q x 06

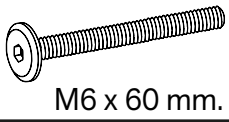

AJ x 01

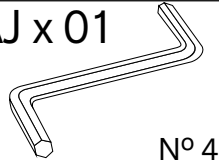

AK x 02

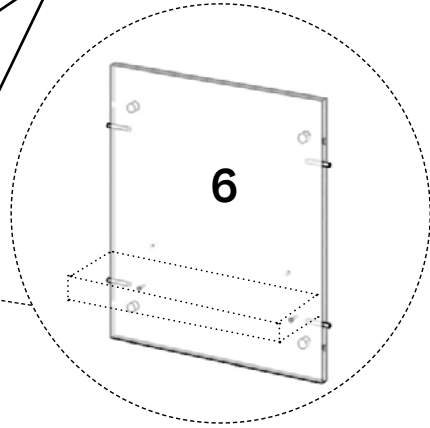
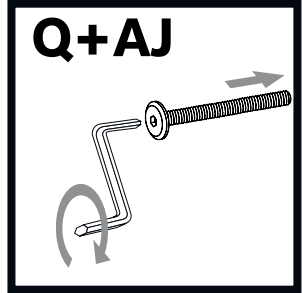
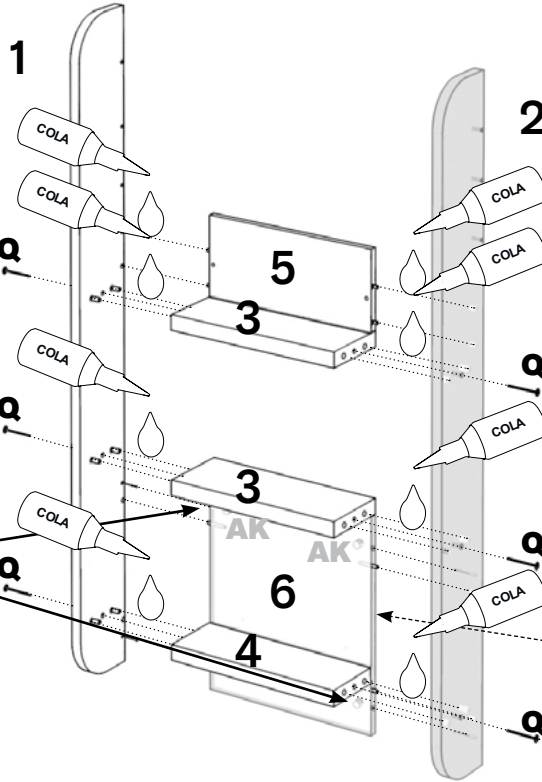
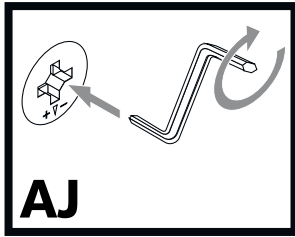
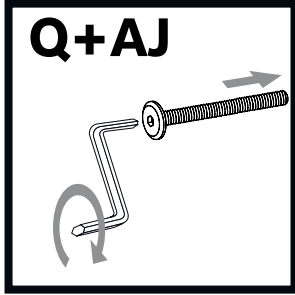
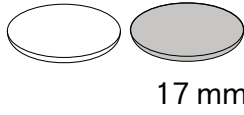

8 C x 01

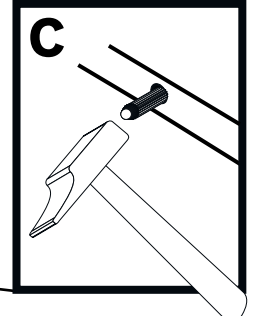
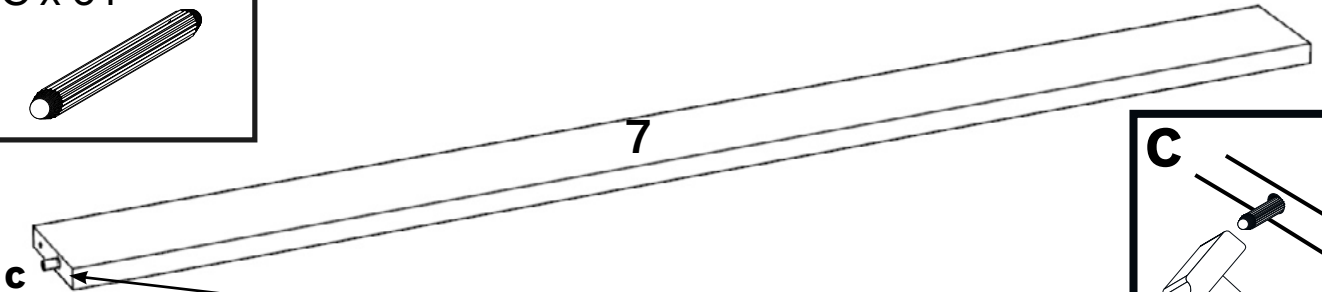
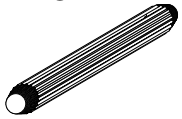

9 AG x 02

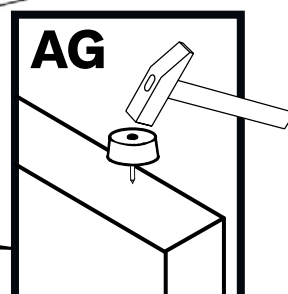
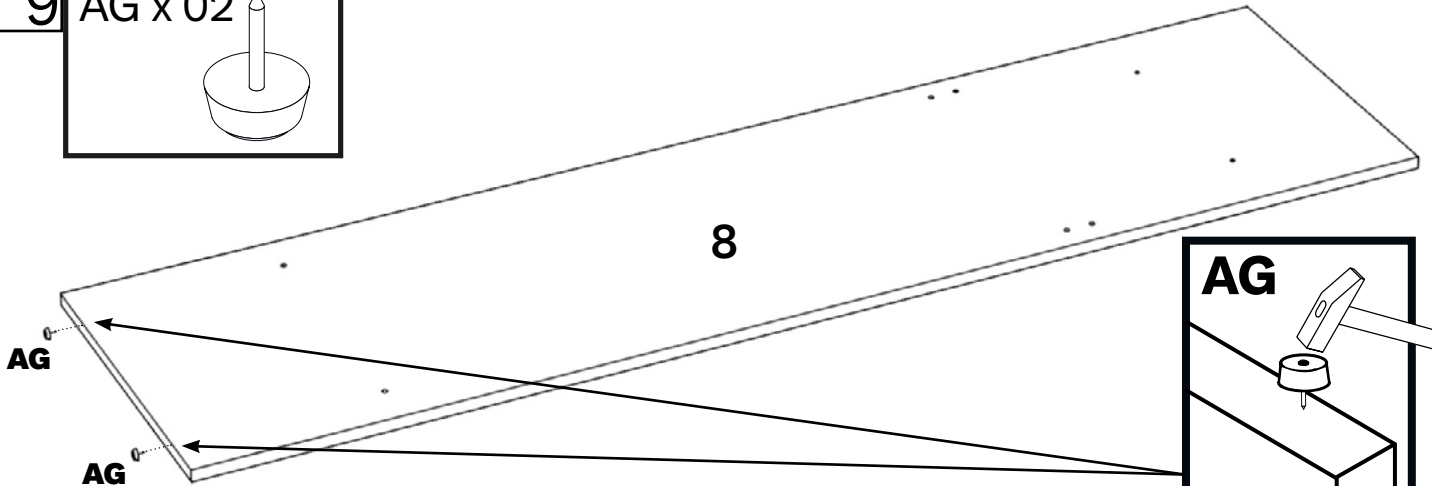
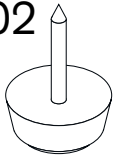

10

\tilde{N} x 03



5 x 60 mm.

AI x 01

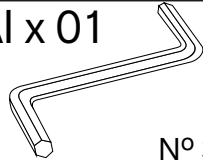

Nº 3

AK x 04

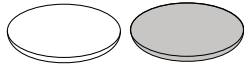

17 mm.

90°

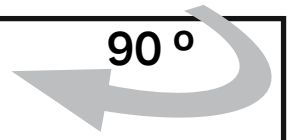

Option A

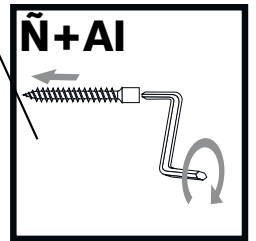
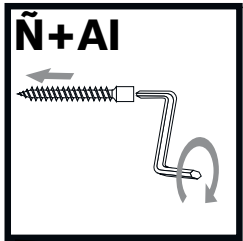
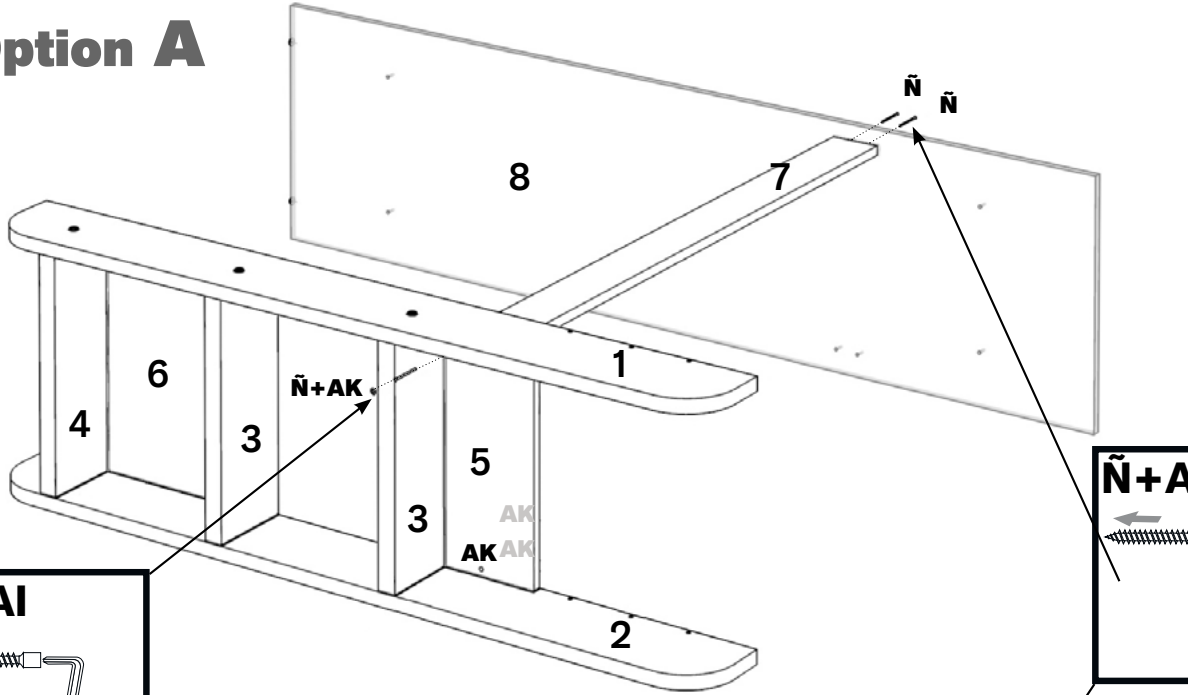



Option B

11

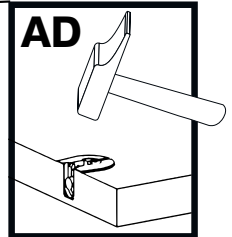
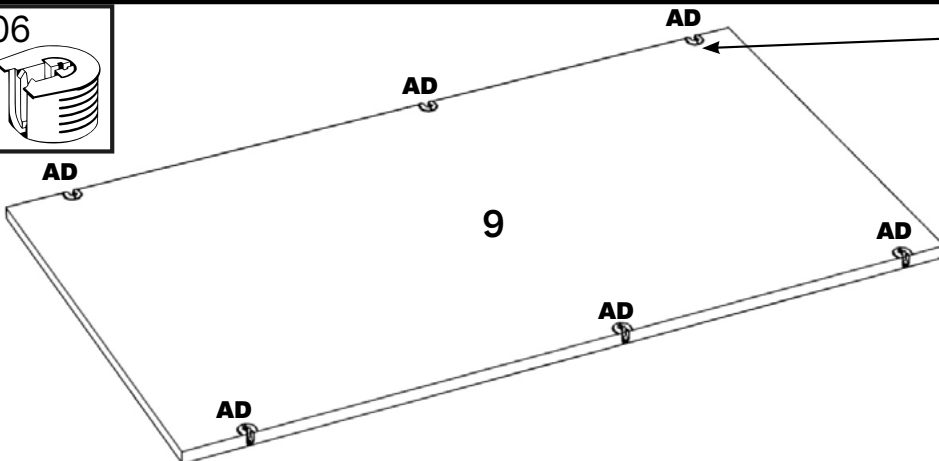
AD x 06

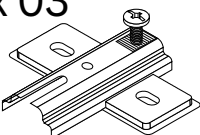
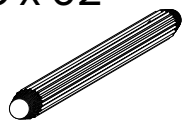
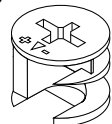
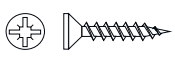

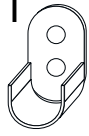
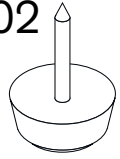
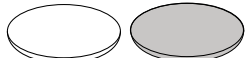
12	B x 03 	C x 02 	F x 03 	G x 08  3.5 x 15 mm.	AE x 03 
AF x 01 		AG x 02 		AK x 03  17 mm.	

Option A

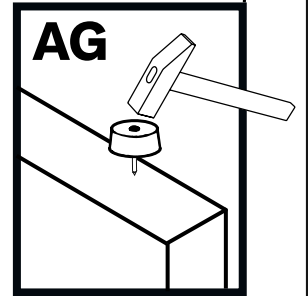
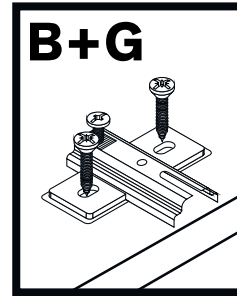
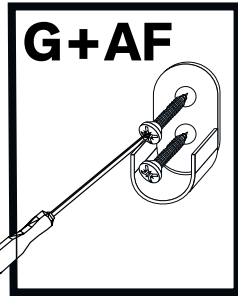
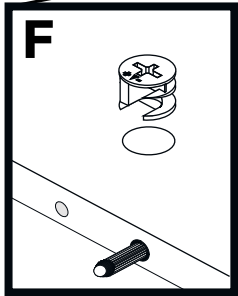
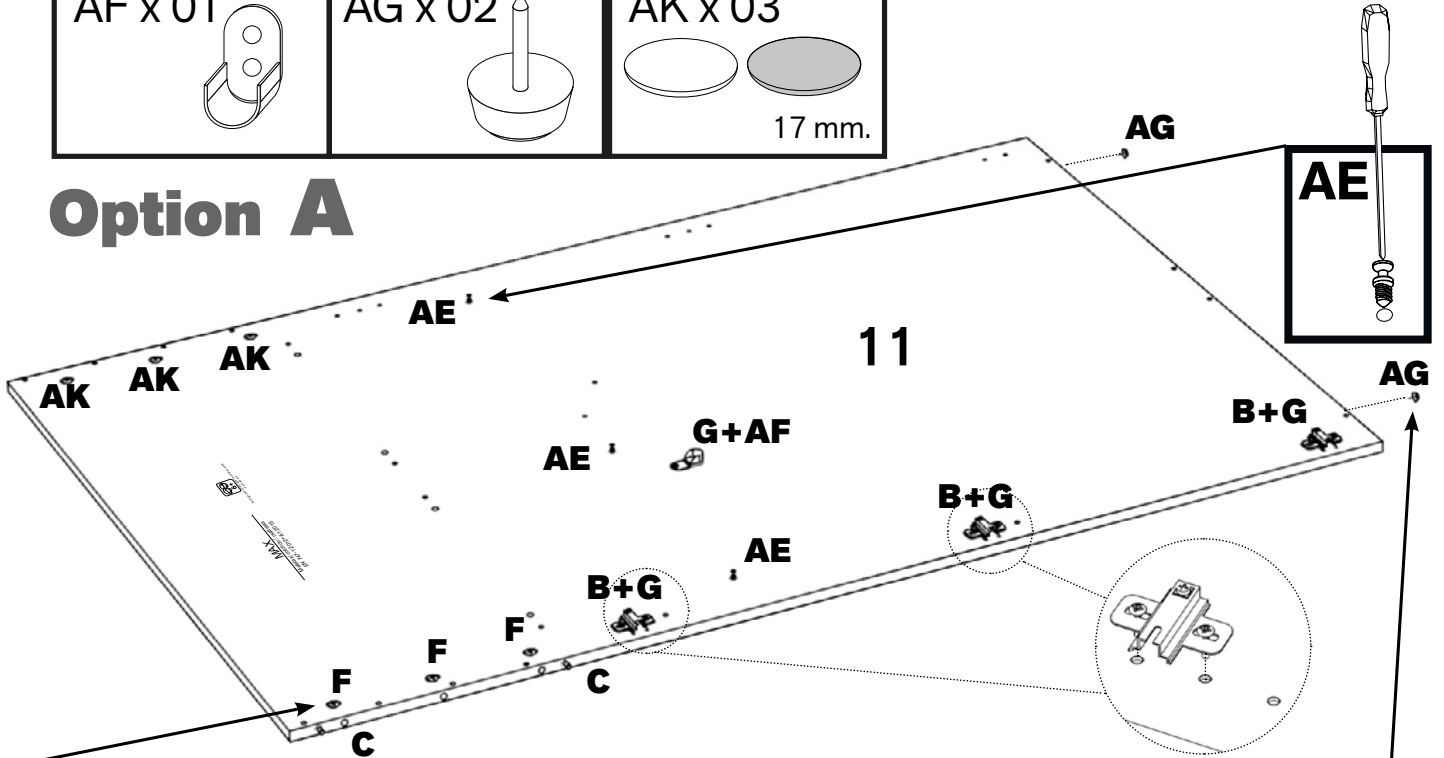

Option B

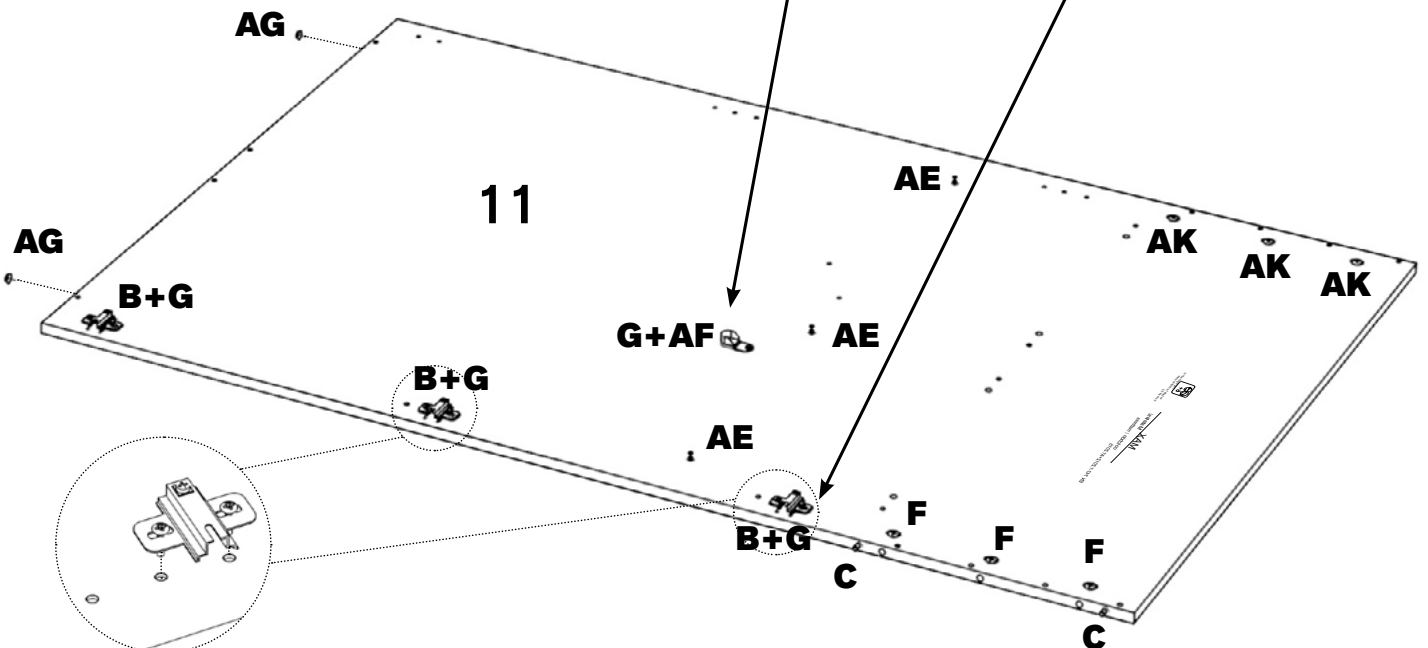

13

G x 08

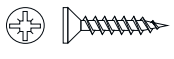

3.5 x 15 mm.

Z x 03

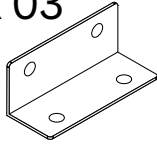

AE x 03



AF x 01

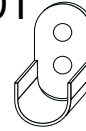

AG x 02

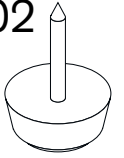

W x 01

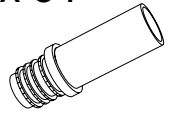

Option A

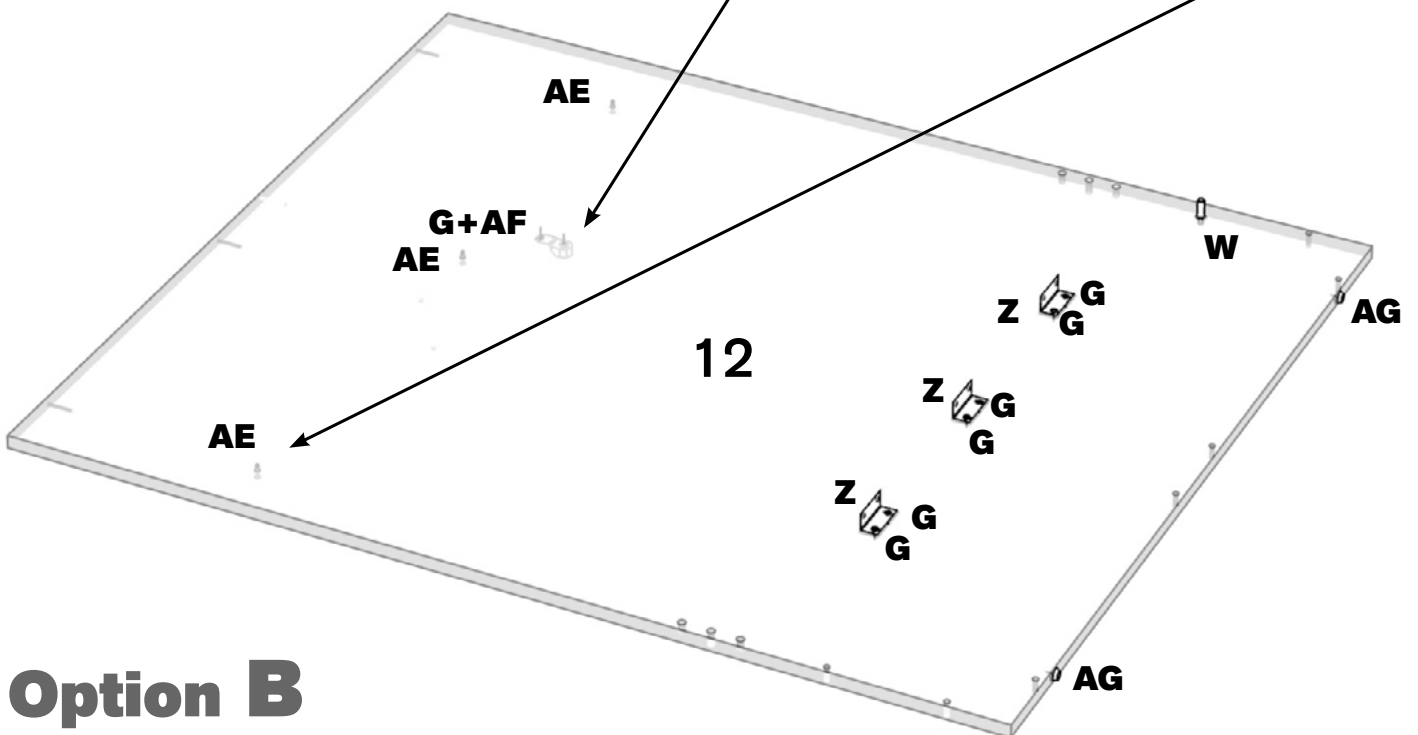
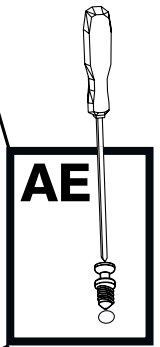
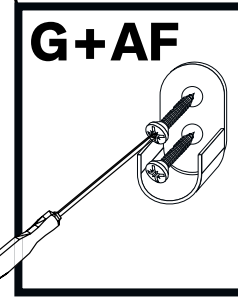
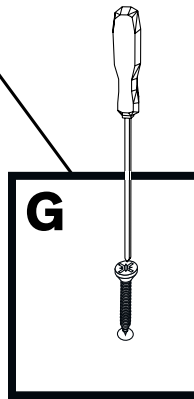
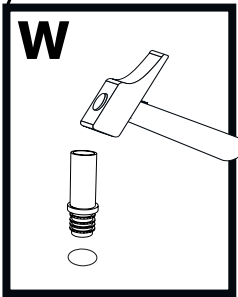
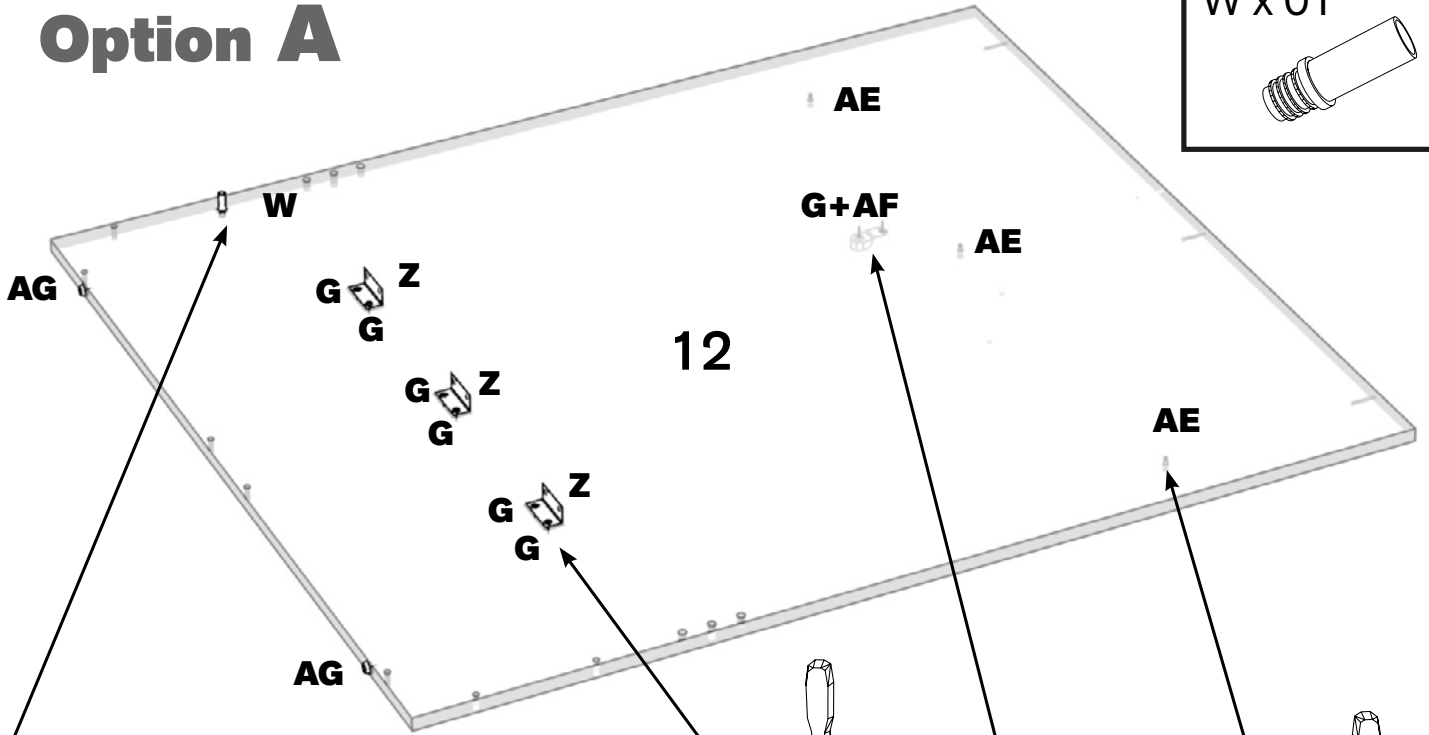

Option B

14

Option A

$\tilde{N} \times 08$

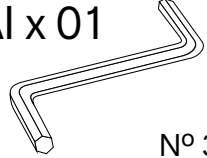
 5 x 60 mm.

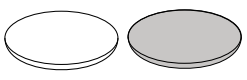
$AI \times 01$

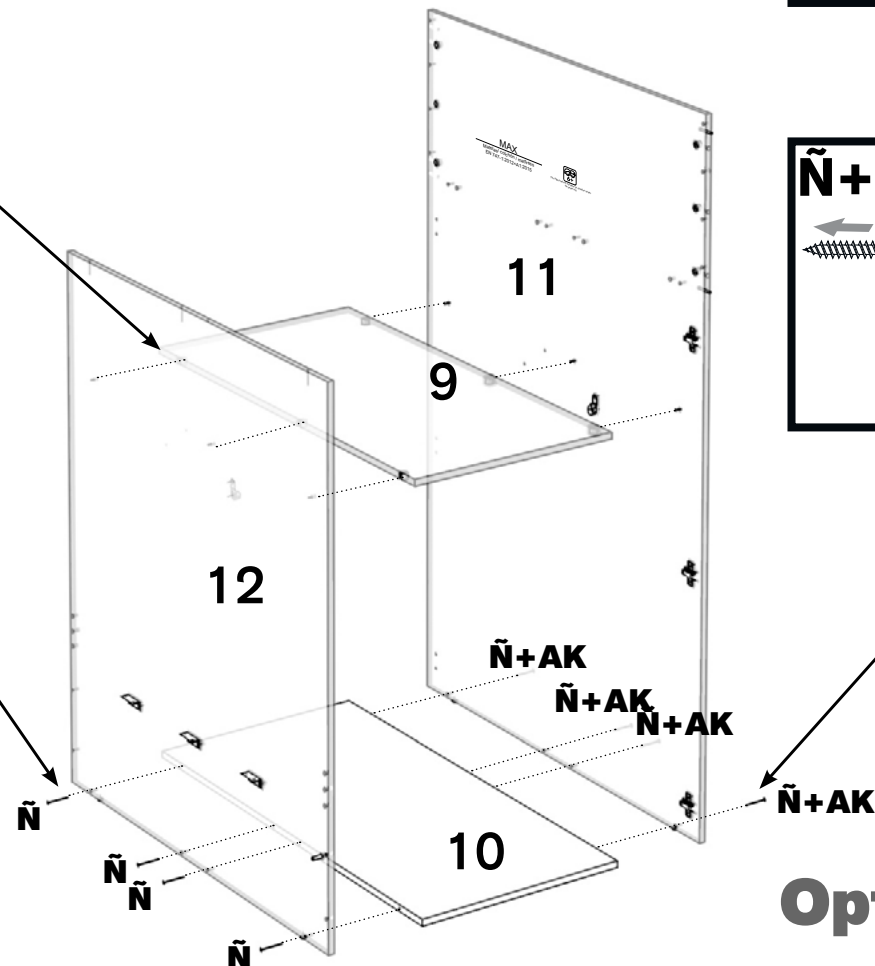
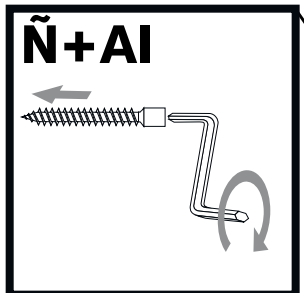
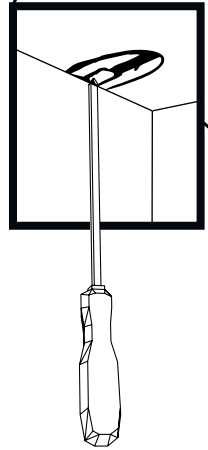
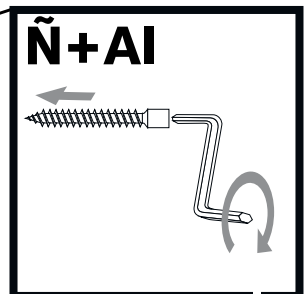
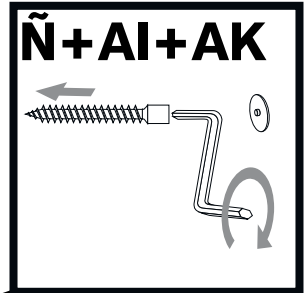
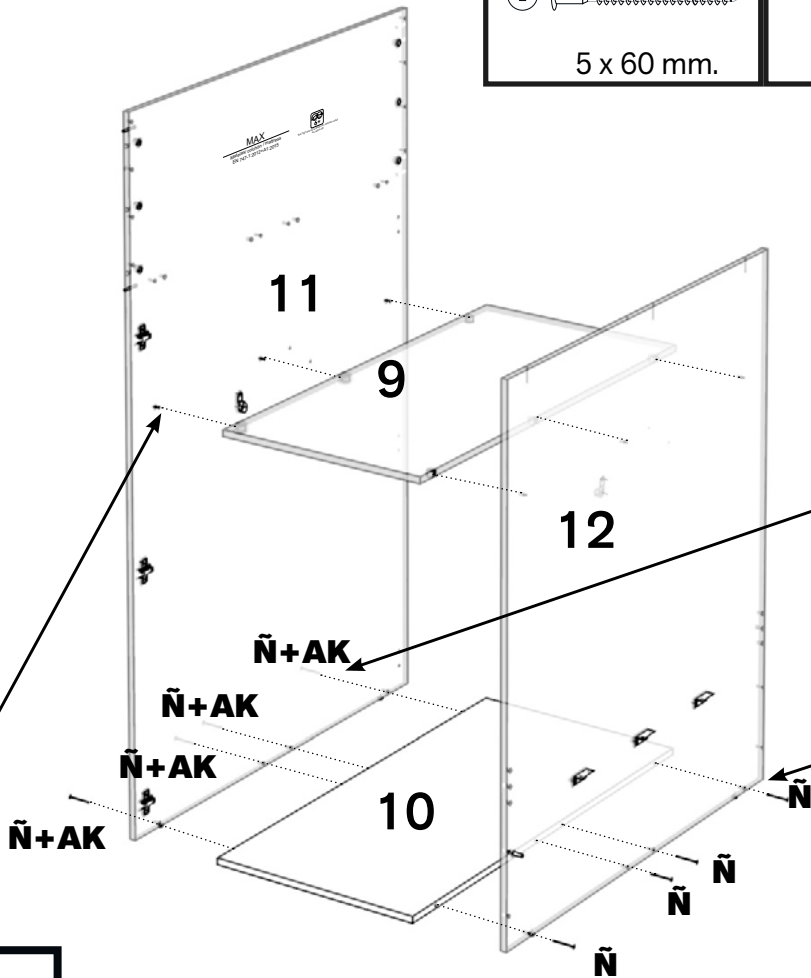
 N° 3

$AK \times 04$

 17 mm.



Option B

15

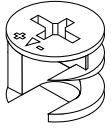
F x 02



AG x 03

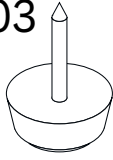

Option A

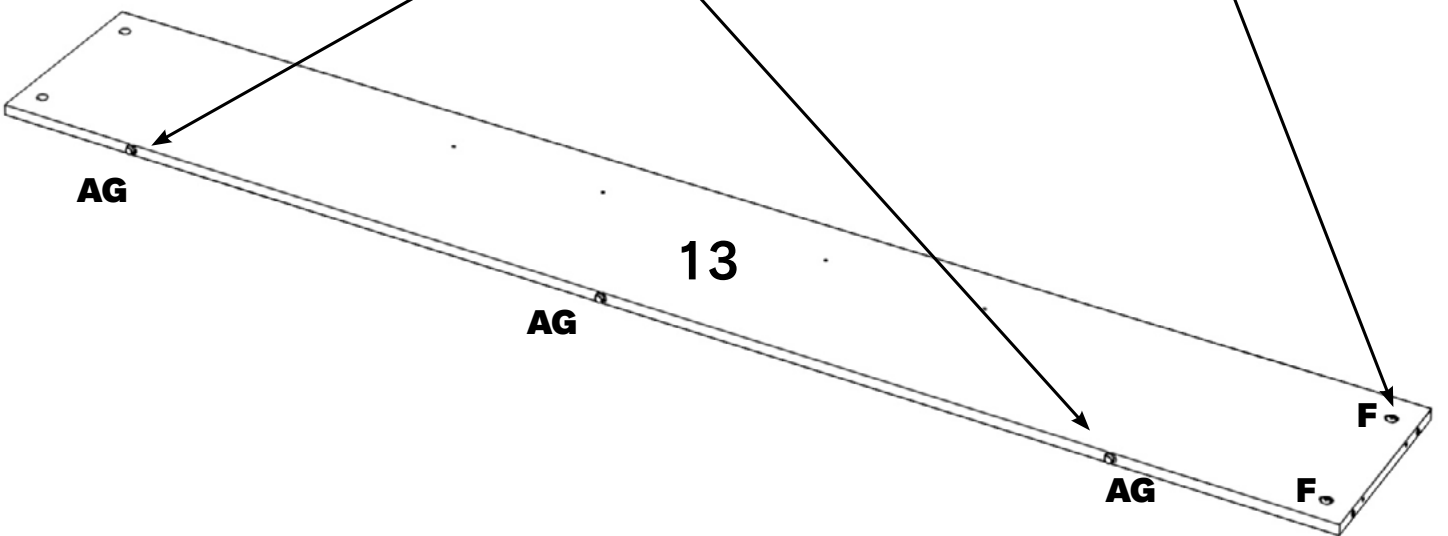
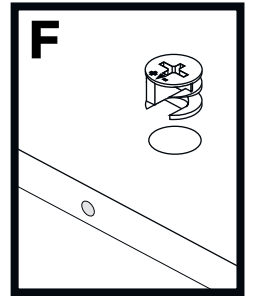
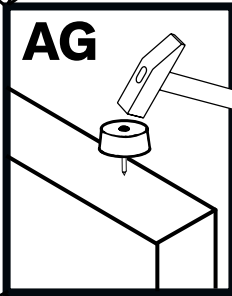
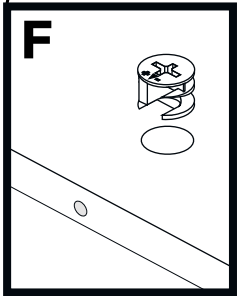
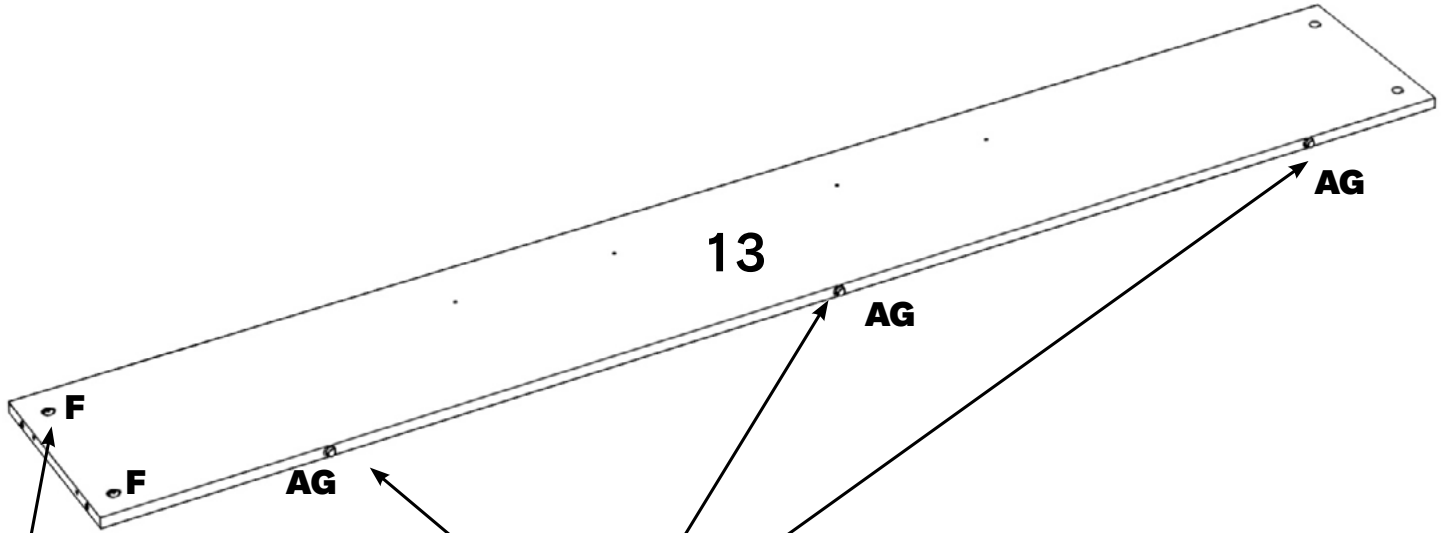

Option B

16

E x 02

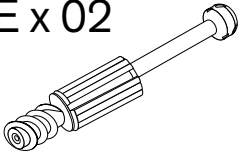

G x 06



3.5 x 15 mm.

W x 01

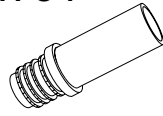

Z x 03

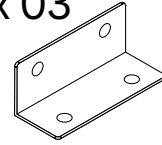

AG x 02

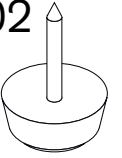

Option A

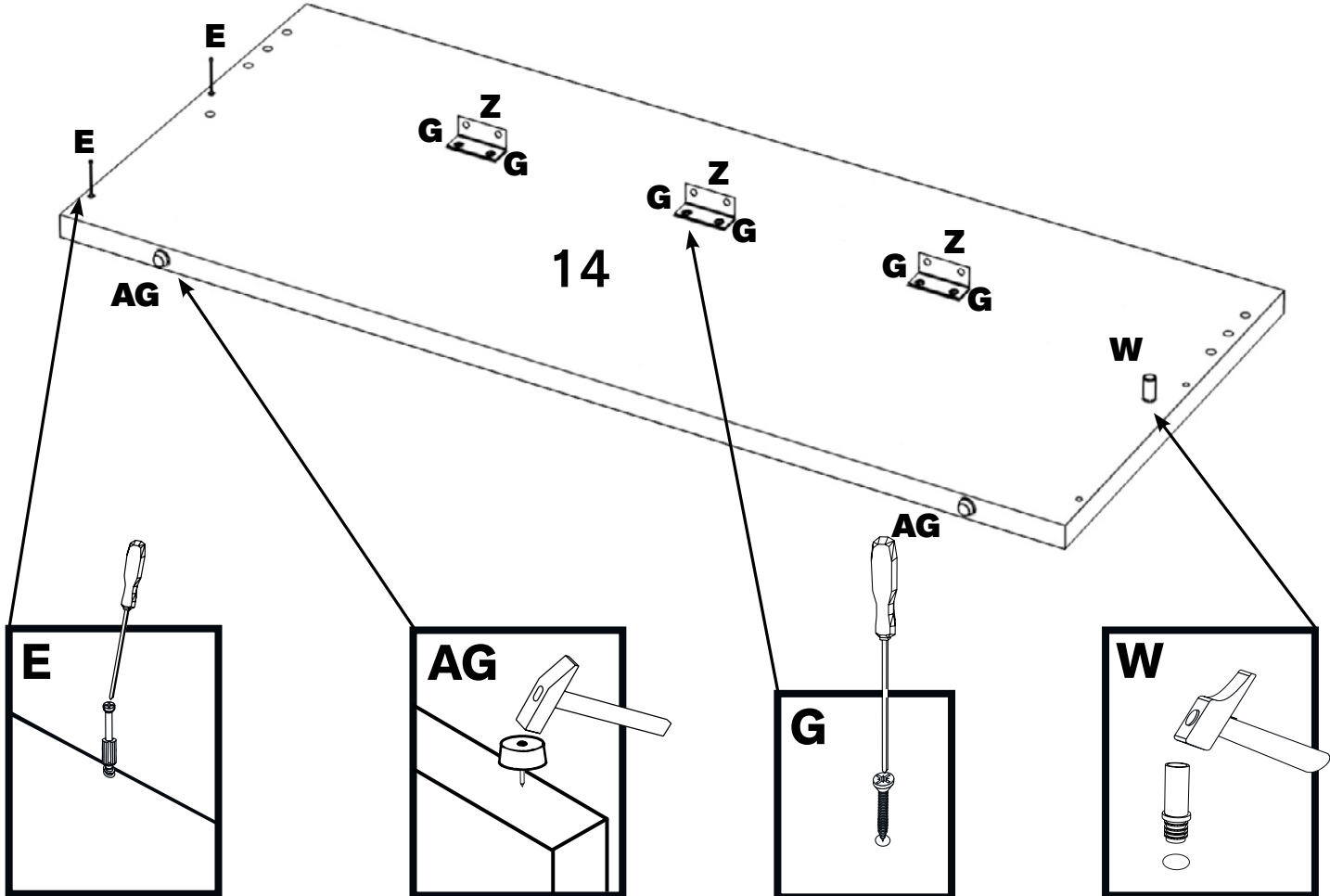

Option B

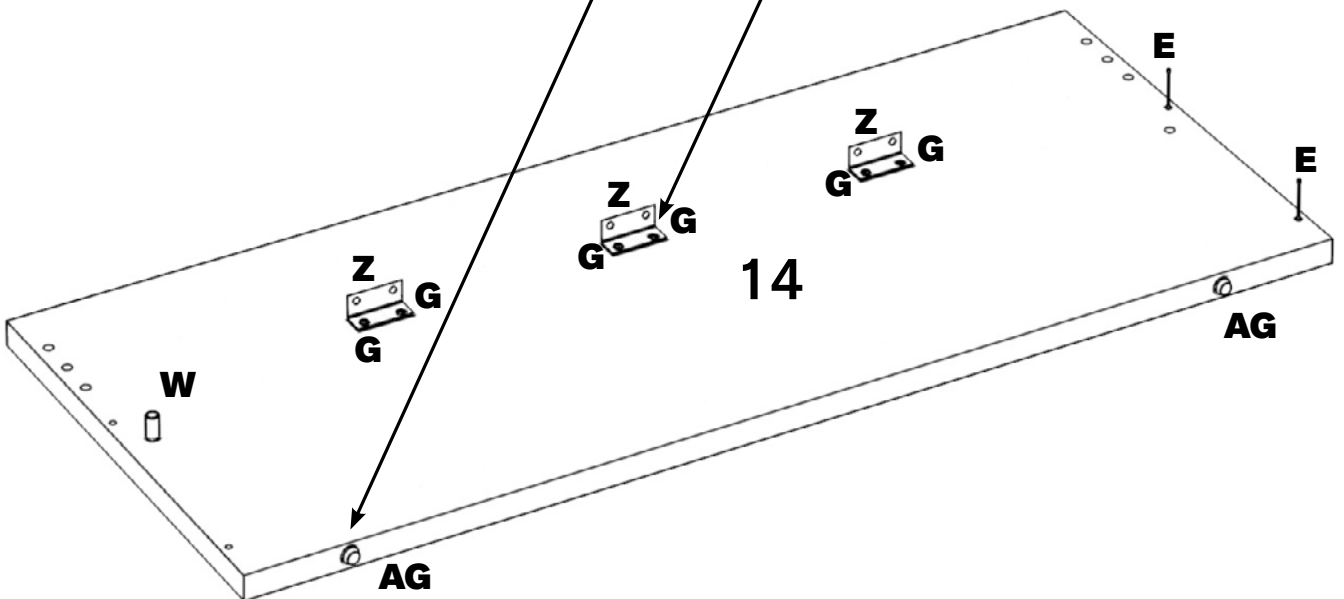

17

C x 04

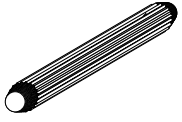

R x 07

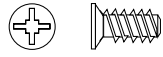

S x 02



13 mm.

Option A

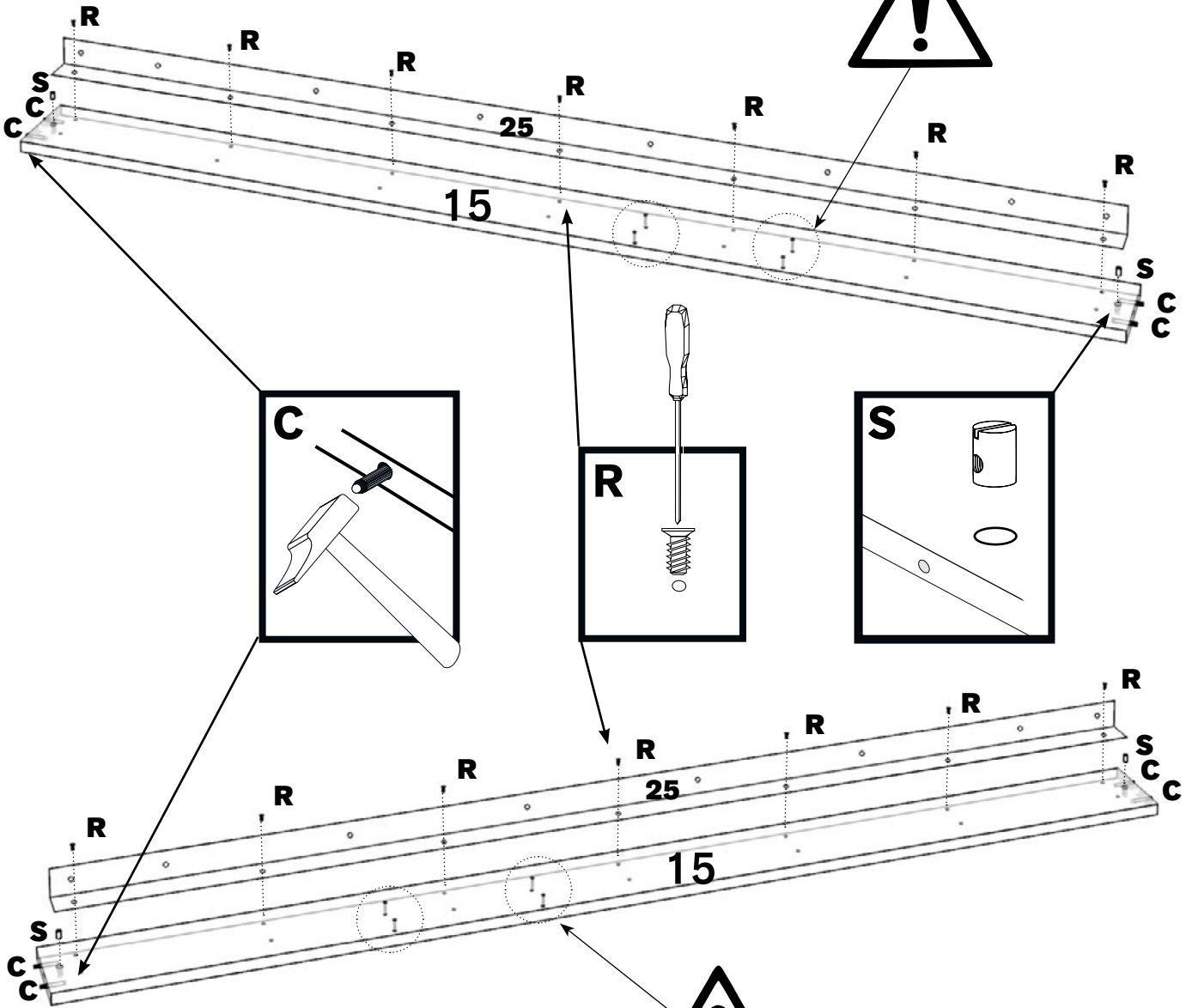

Option B

18

C x 04

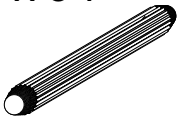

16 (x2)

C
C

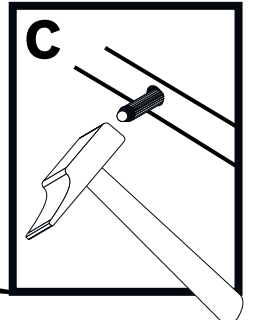

19

Ñ x 02



5 x 60 mm.

Q x 02

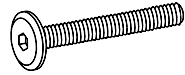

M6 x 60 mm.

AI x 01

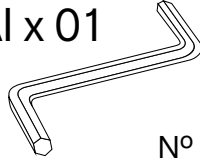

Nº 3

AJ x 01

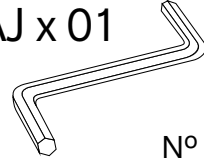

Nº 4

Option A

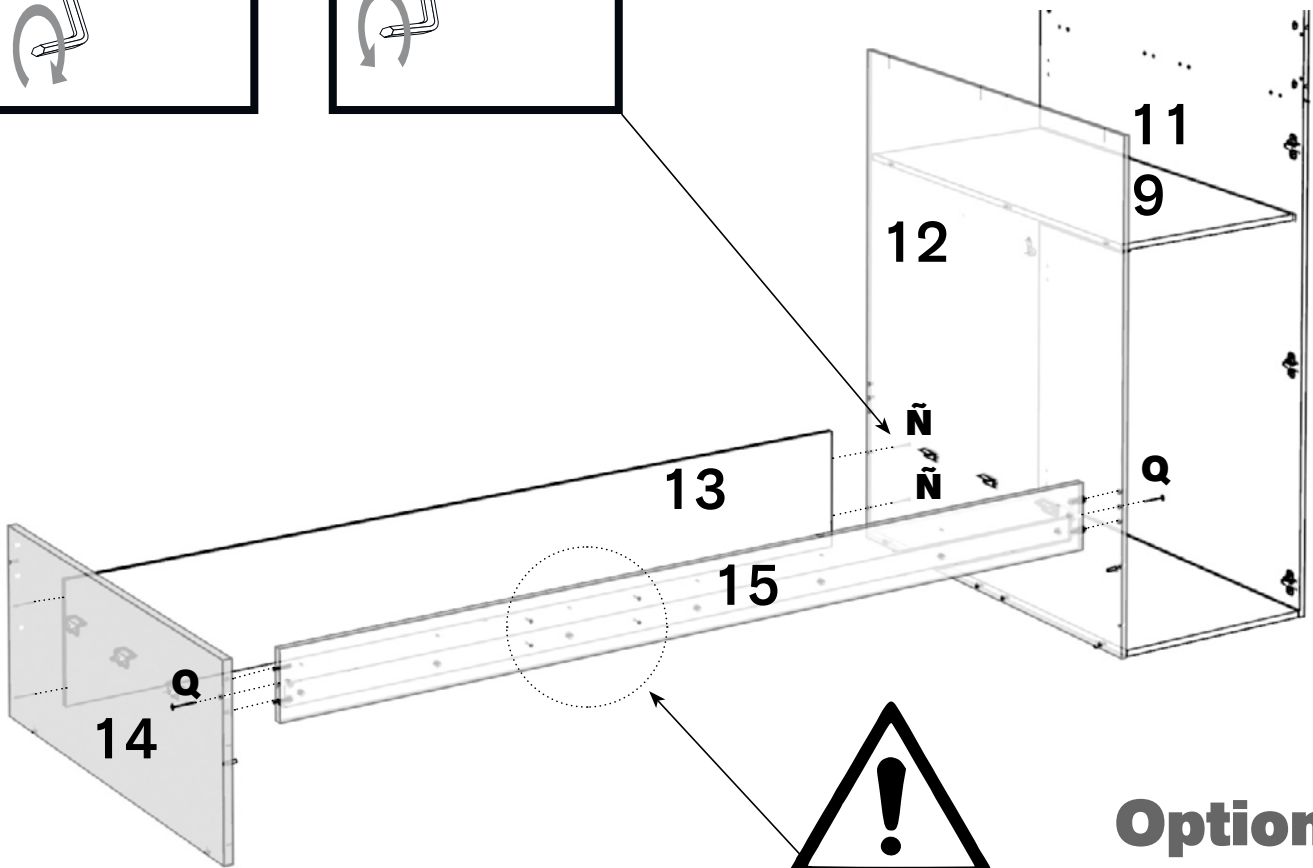
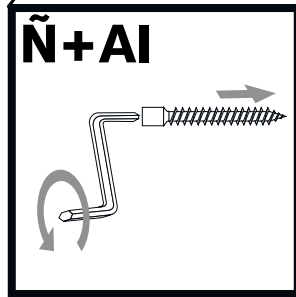
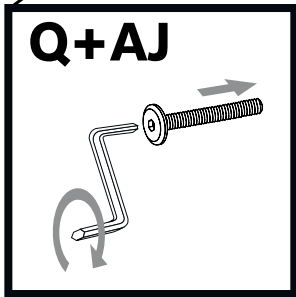
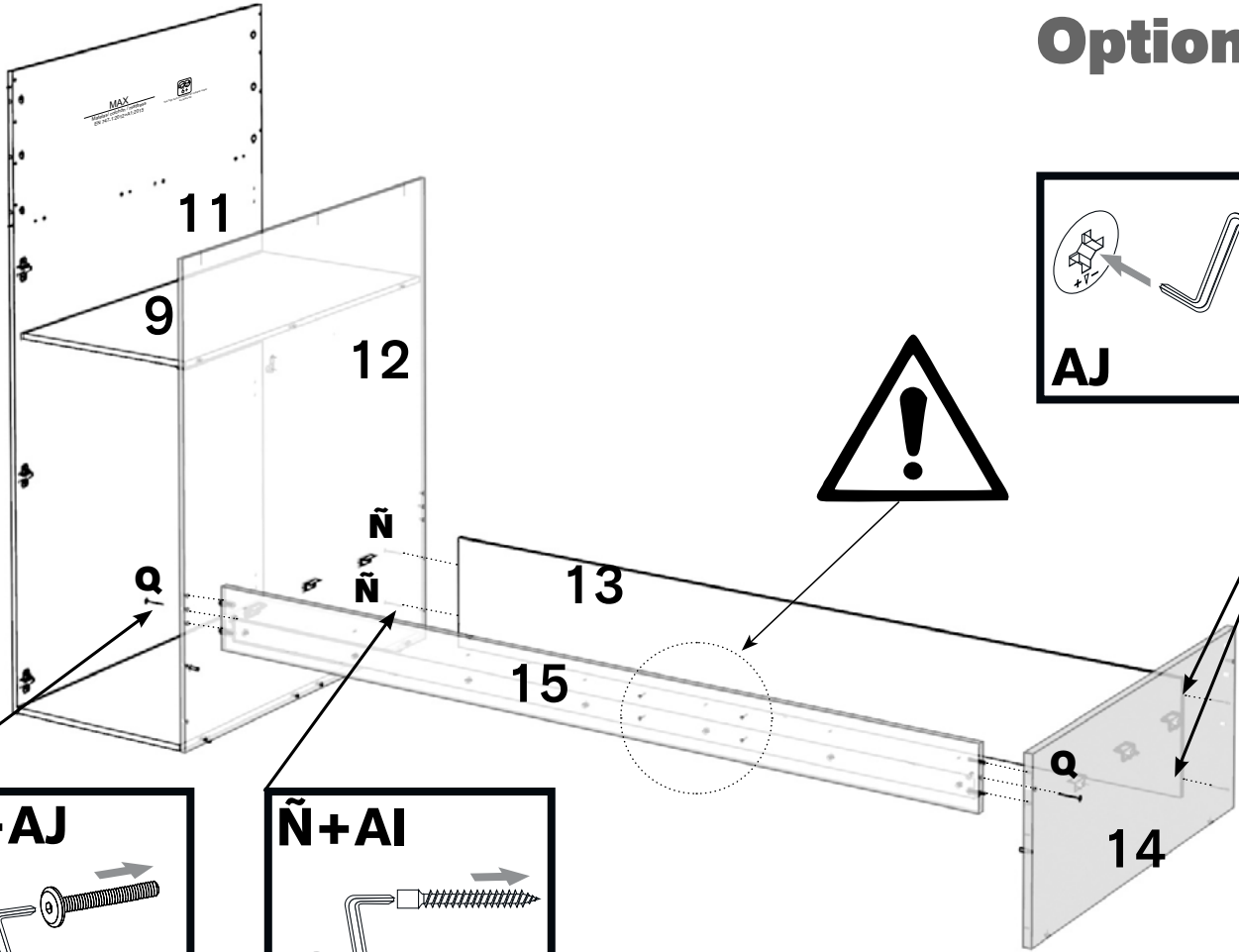

Option B

L x 02



M4 x 15 mm.

N x 02



M4 x 29 mm.

Option A

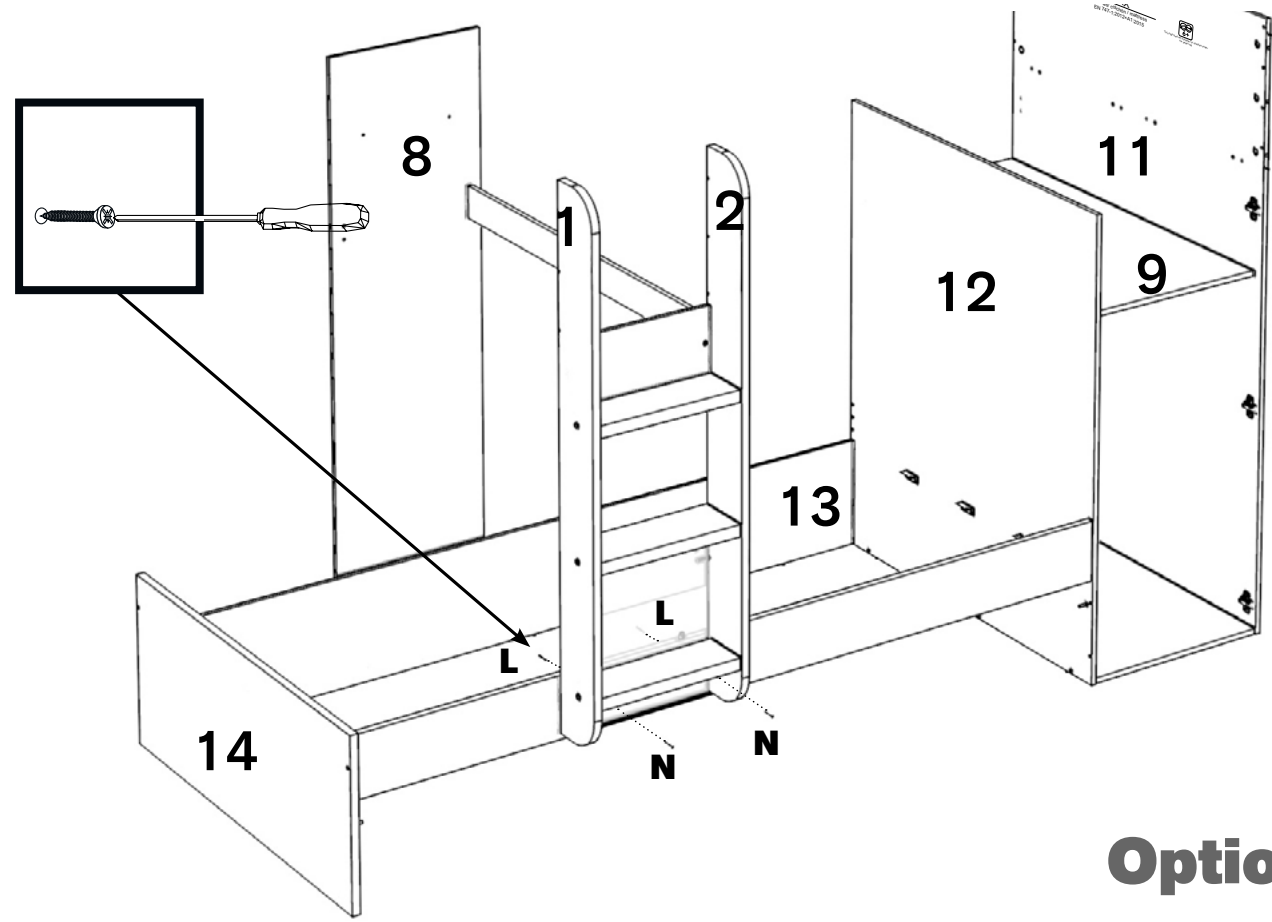
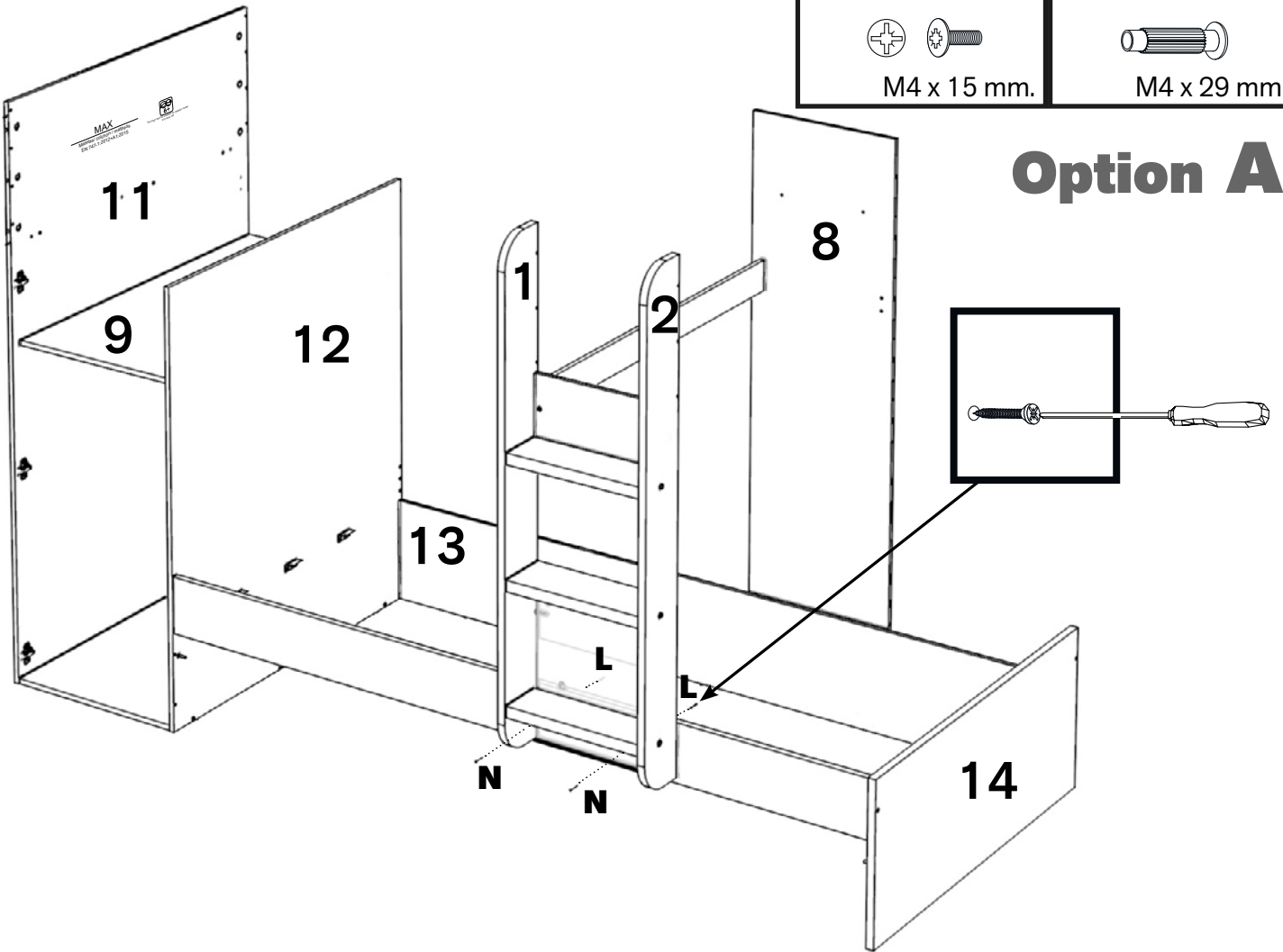

Option B

21

Option A

\tilde{N} x 08



5 x 60 mm.

AI x 01

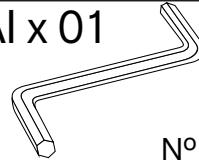

Nº 3

AK x 04

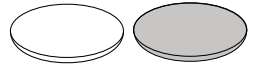

17 mm.

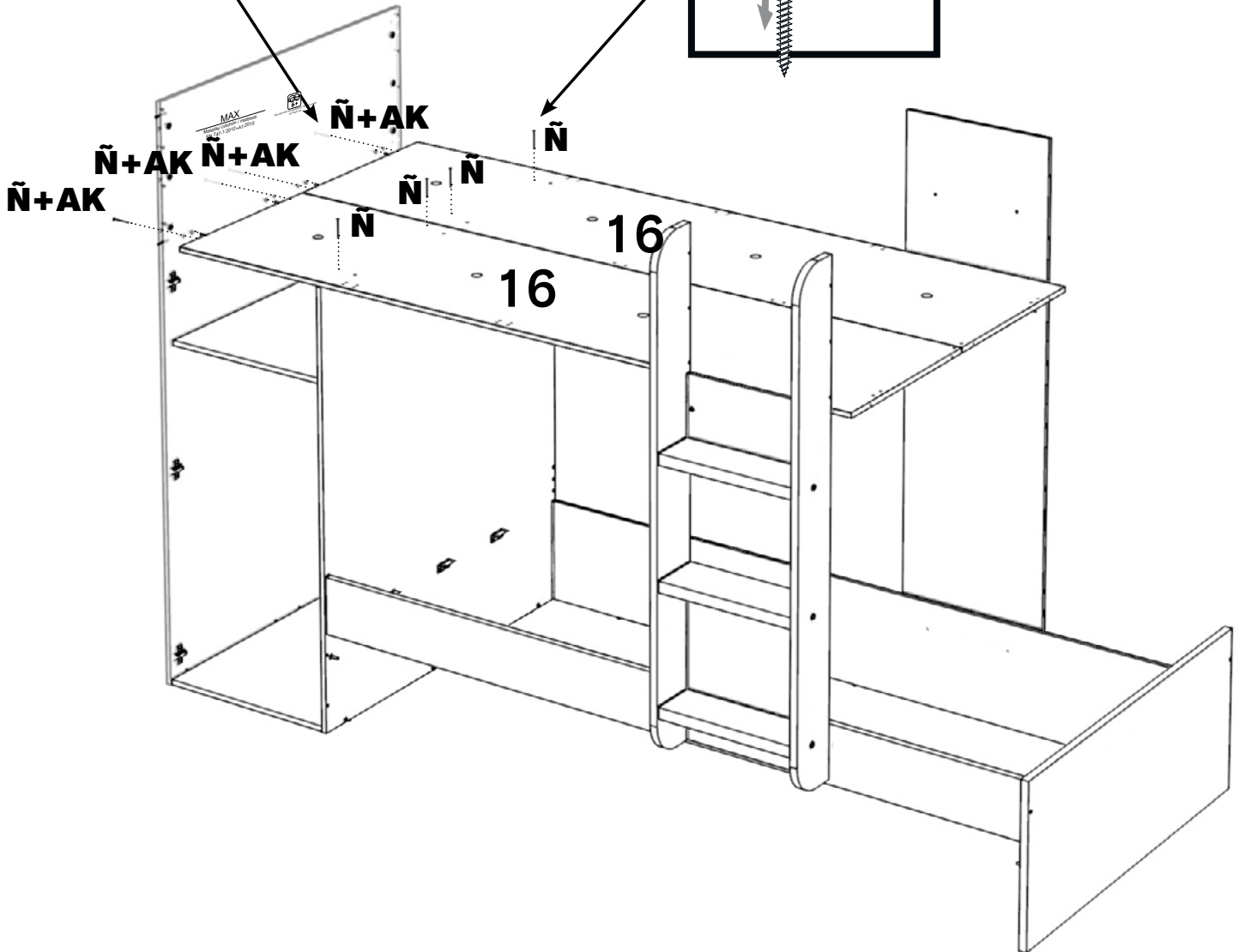
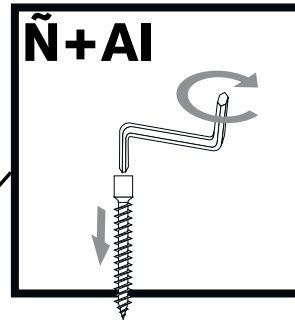
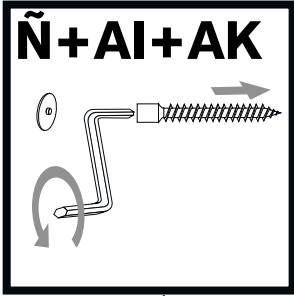

21

Option B

\tilde{N} x 08



5 x 60 mm.

AI x 01

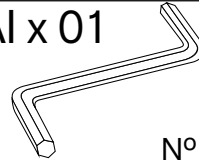

Nº 3

AK x 04

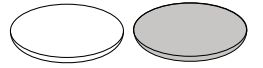

17 mm.

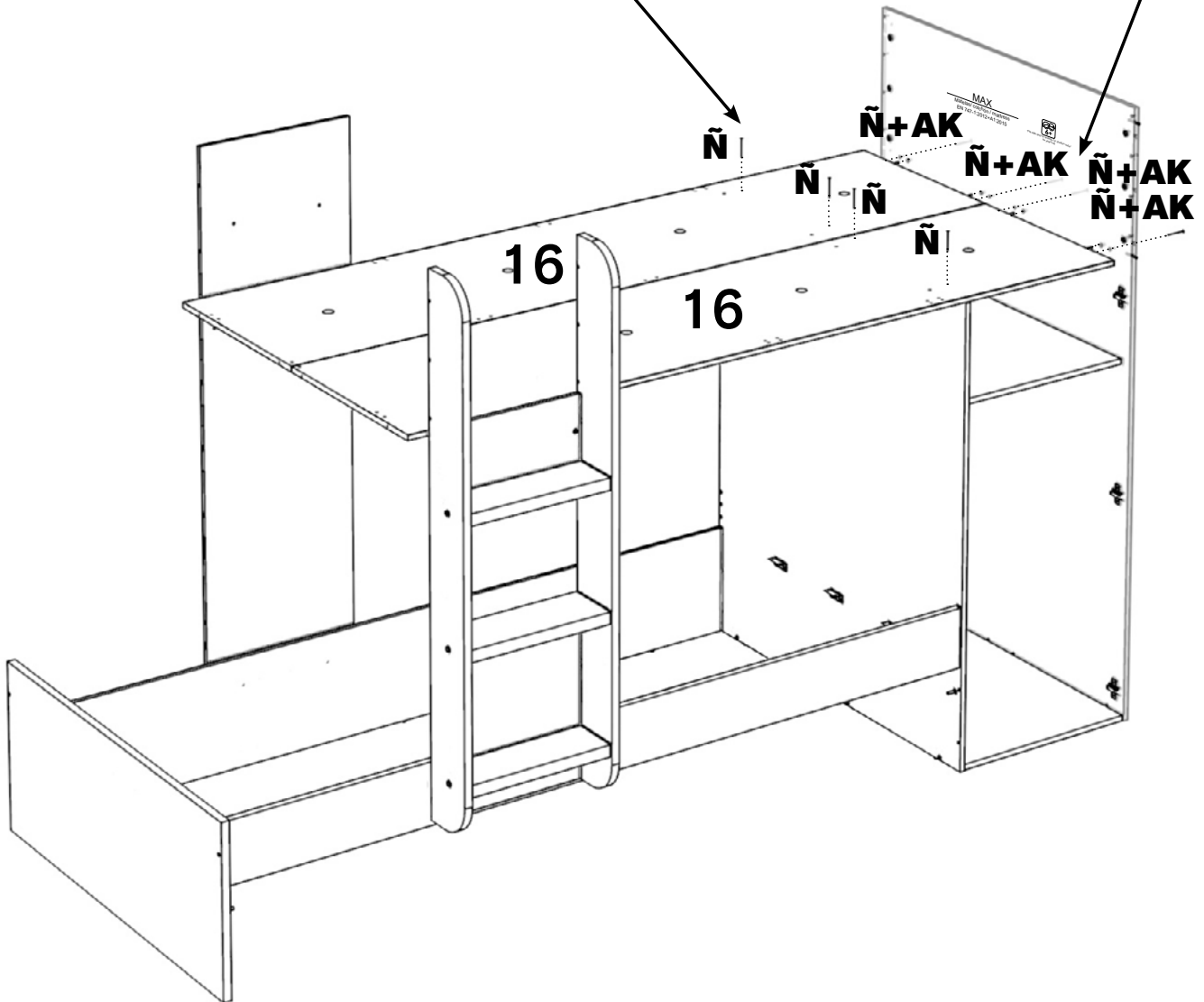
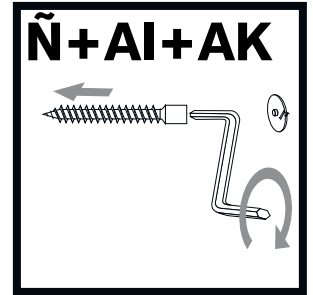
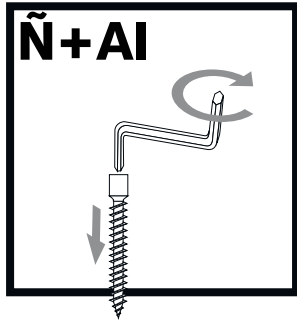

22

G x 08

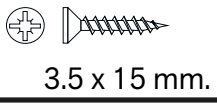

V x 30

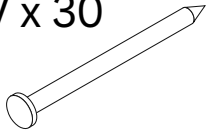

AA x 02

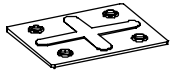

180°

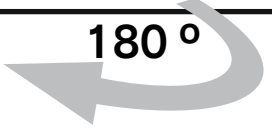

Option A

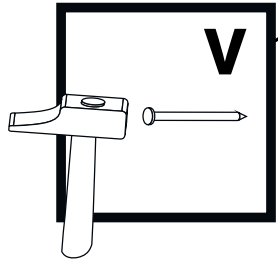
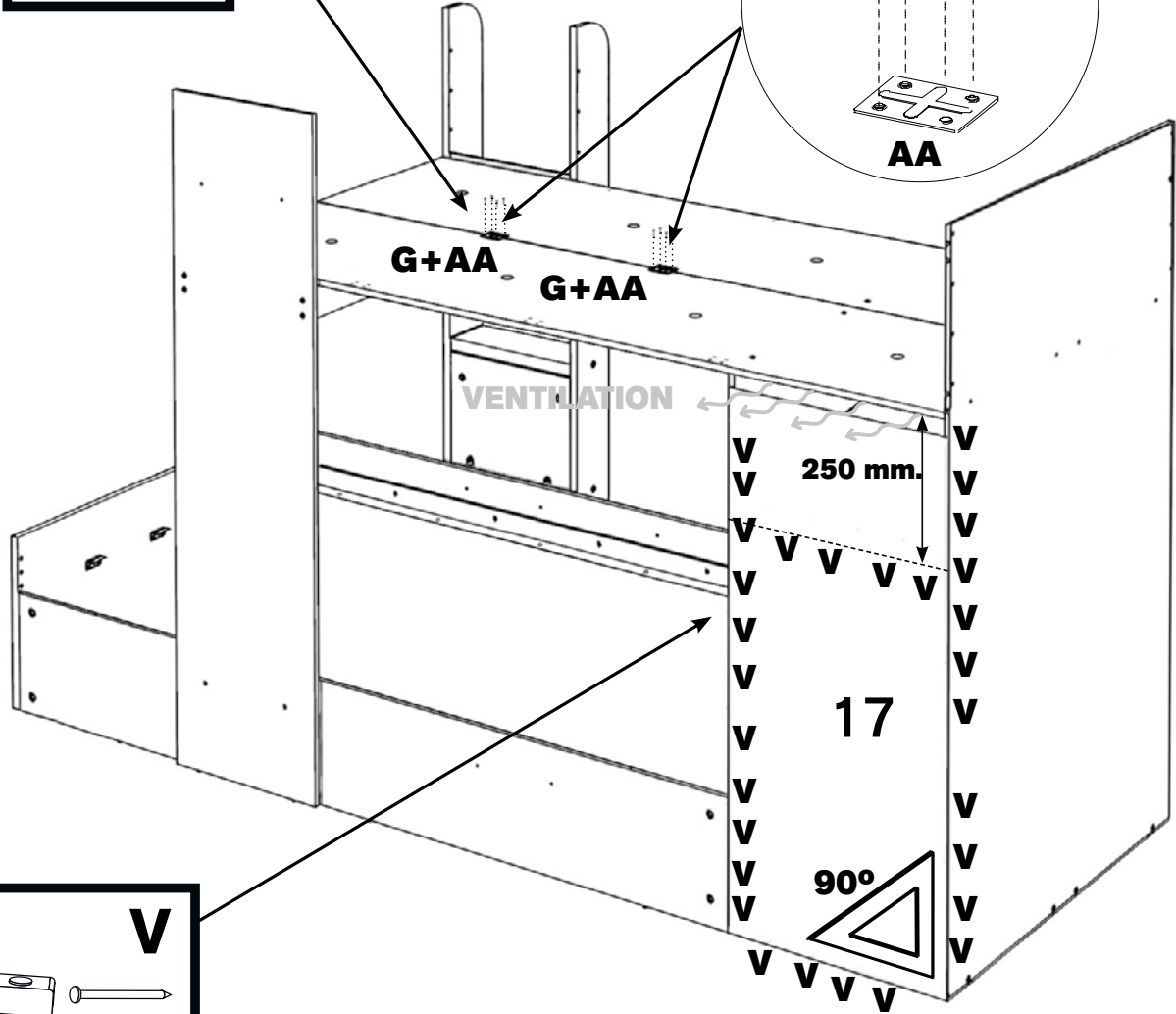
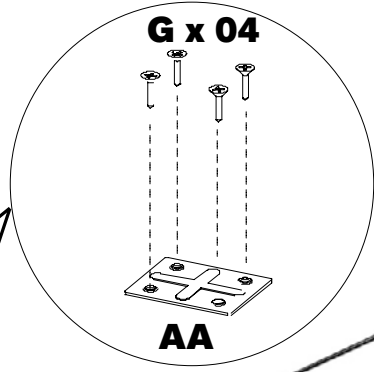
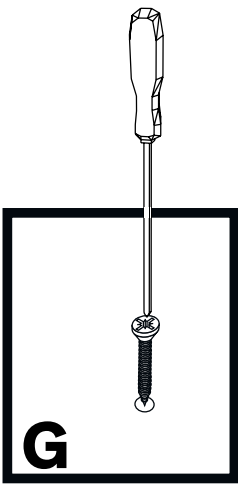

23

E x 03

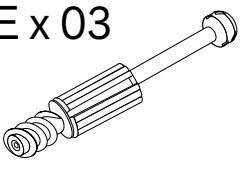

Y x 01

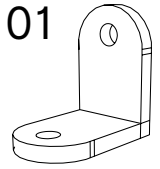

Z x 03

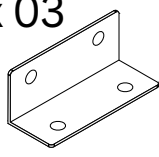

AM x 07

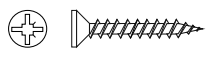

4x 20 mm.

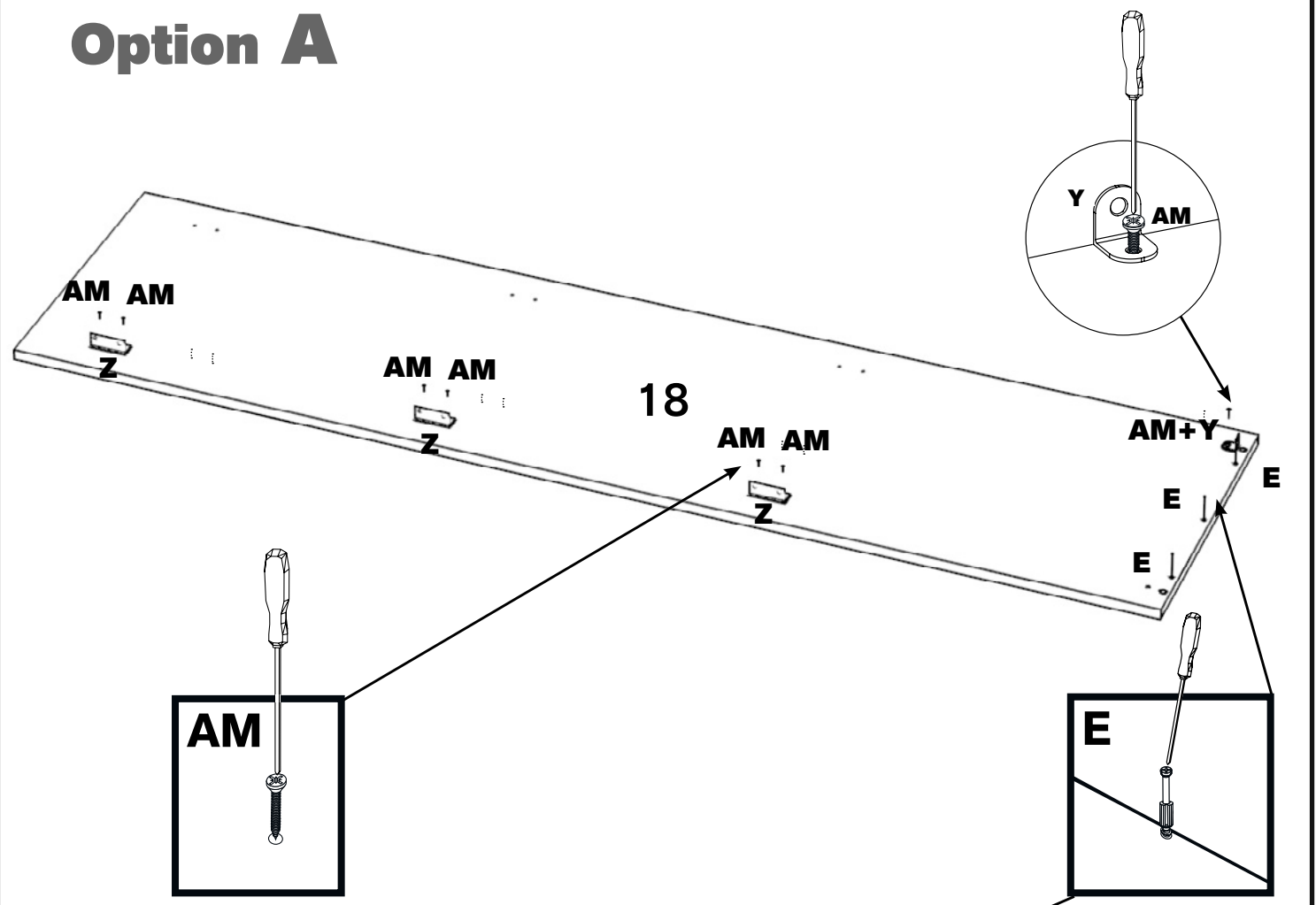

Option A

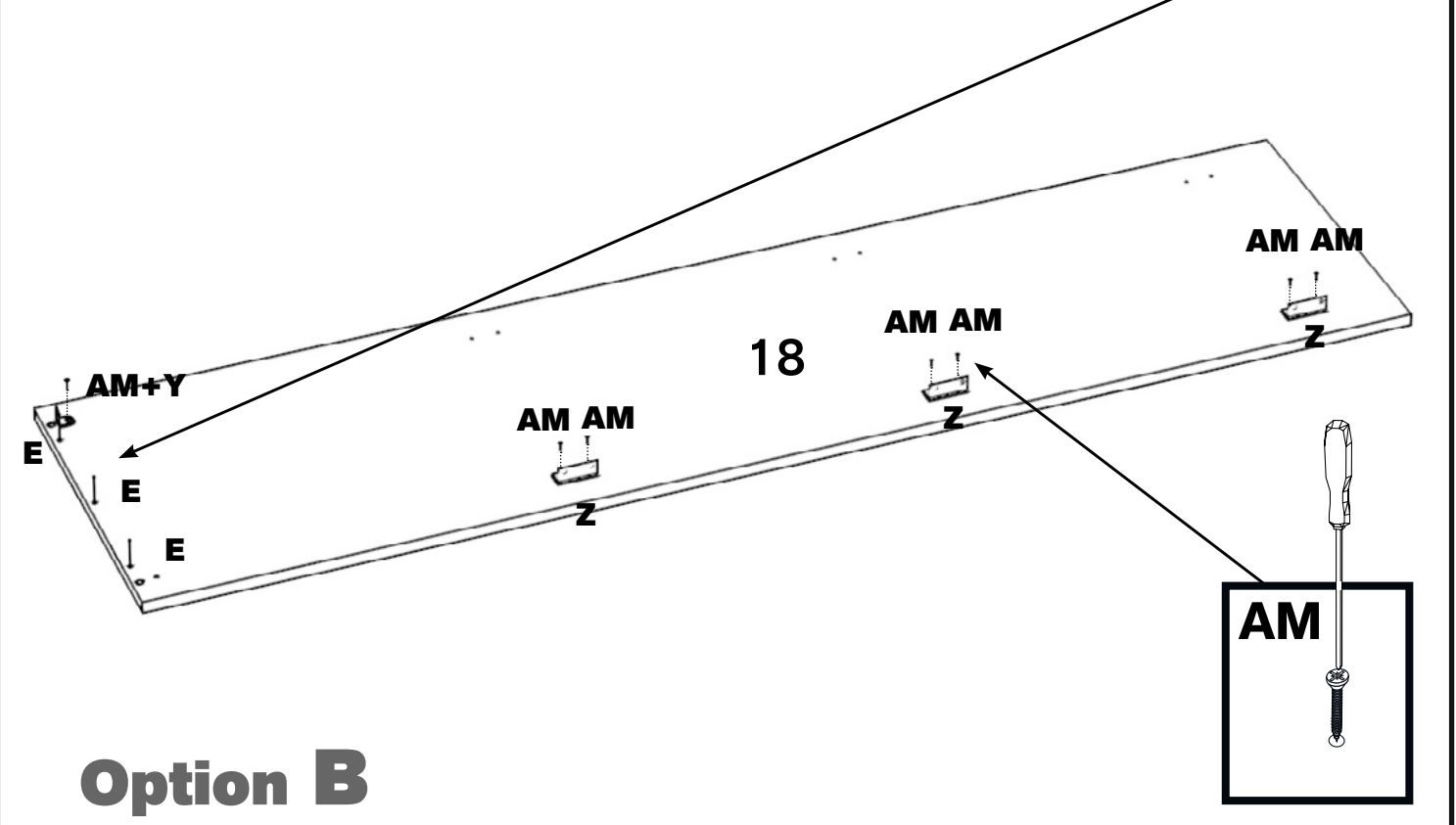

Option B

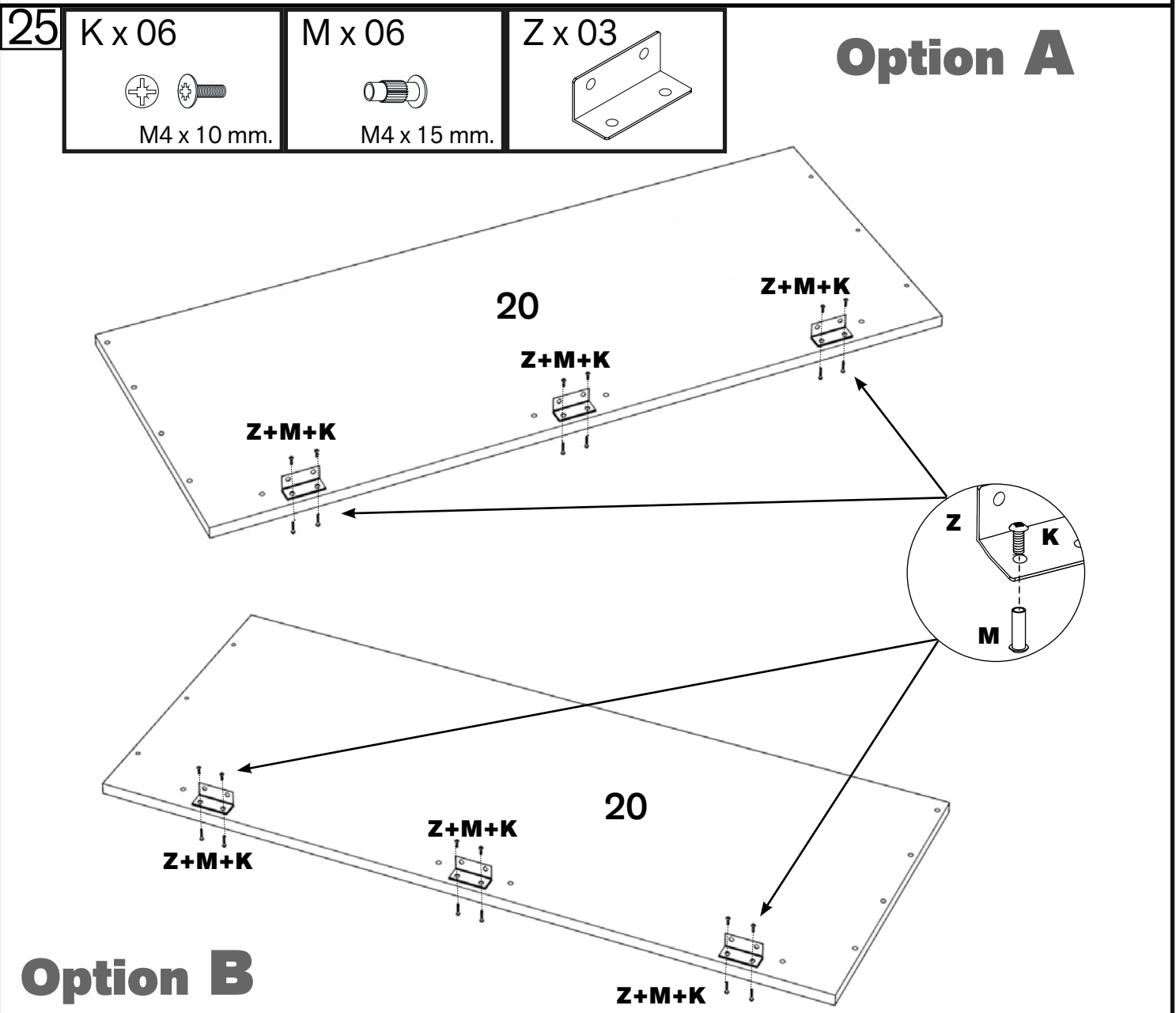
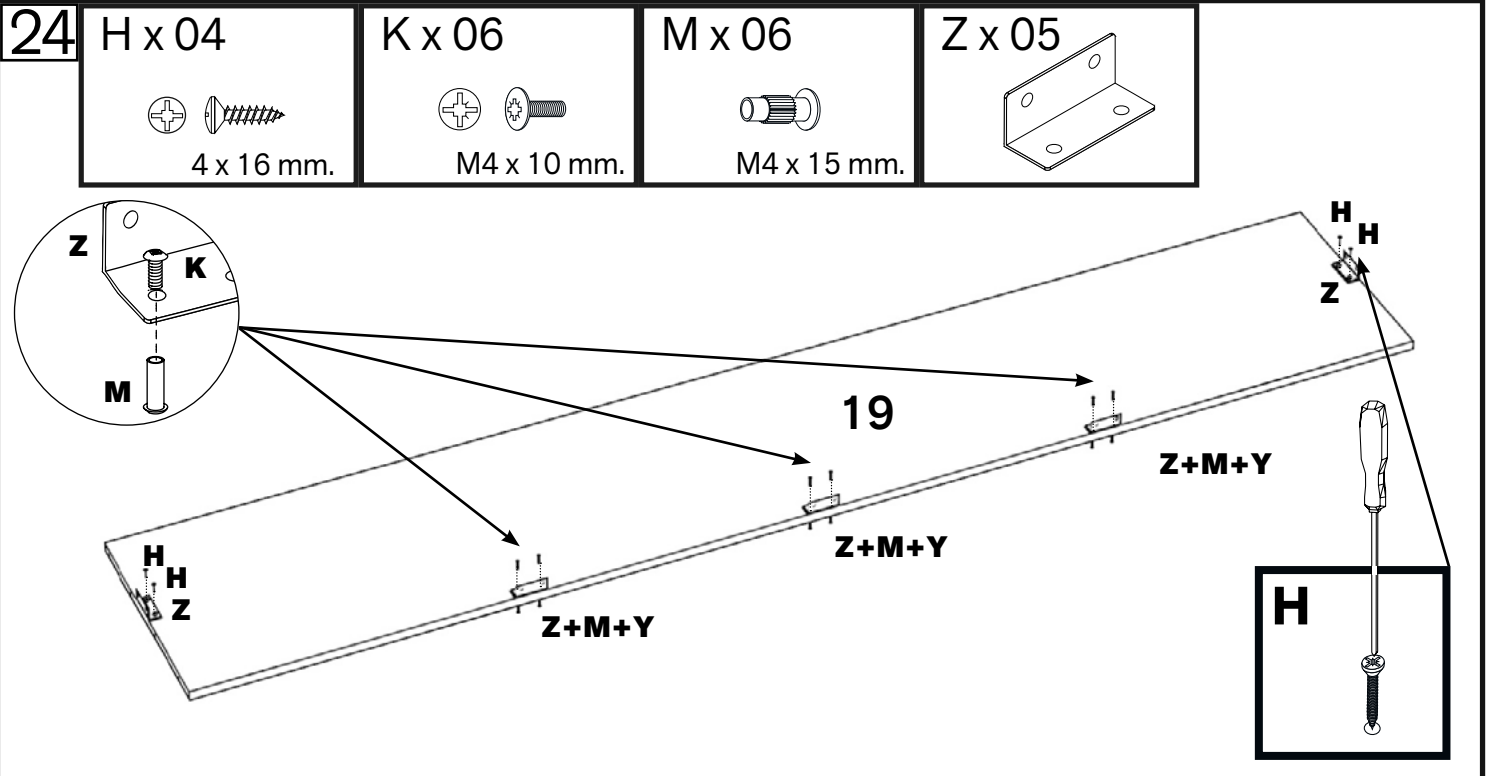

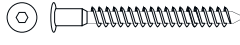
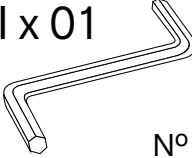
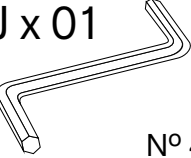

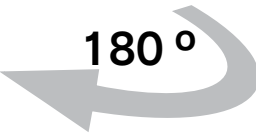
26	$\tilde{N} \times 07$  5 x 60 mm.	$AI \times 01$  Nº 3	$AJ \times 01$  Nº 4	$AK \times 18$  17 mm.	
----	--	---	---	---	---

Option A

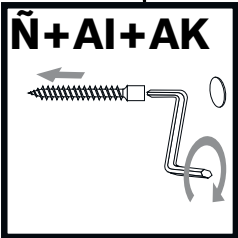
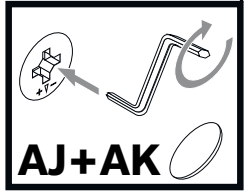
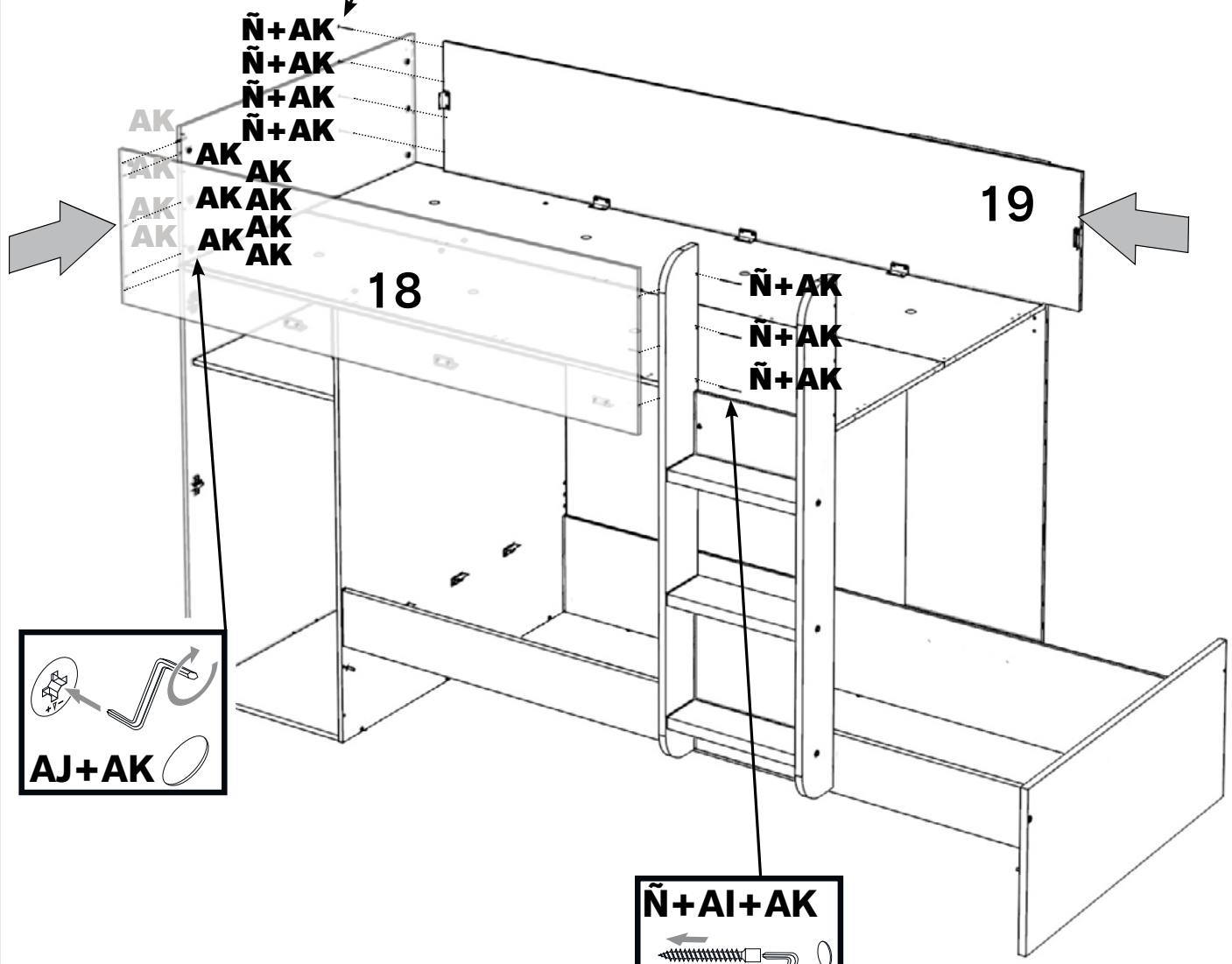

26

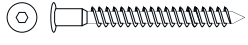
$\tilde{N} \times 07$

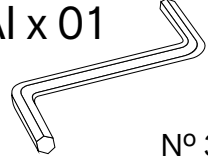
 5 x 60 mm.

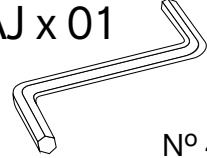
$AI \times 01$

 Nº 3

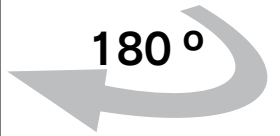
$AJ \times 01$

 Nº 4

$AK \times 18$

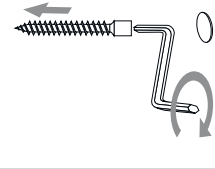
 17 mm.



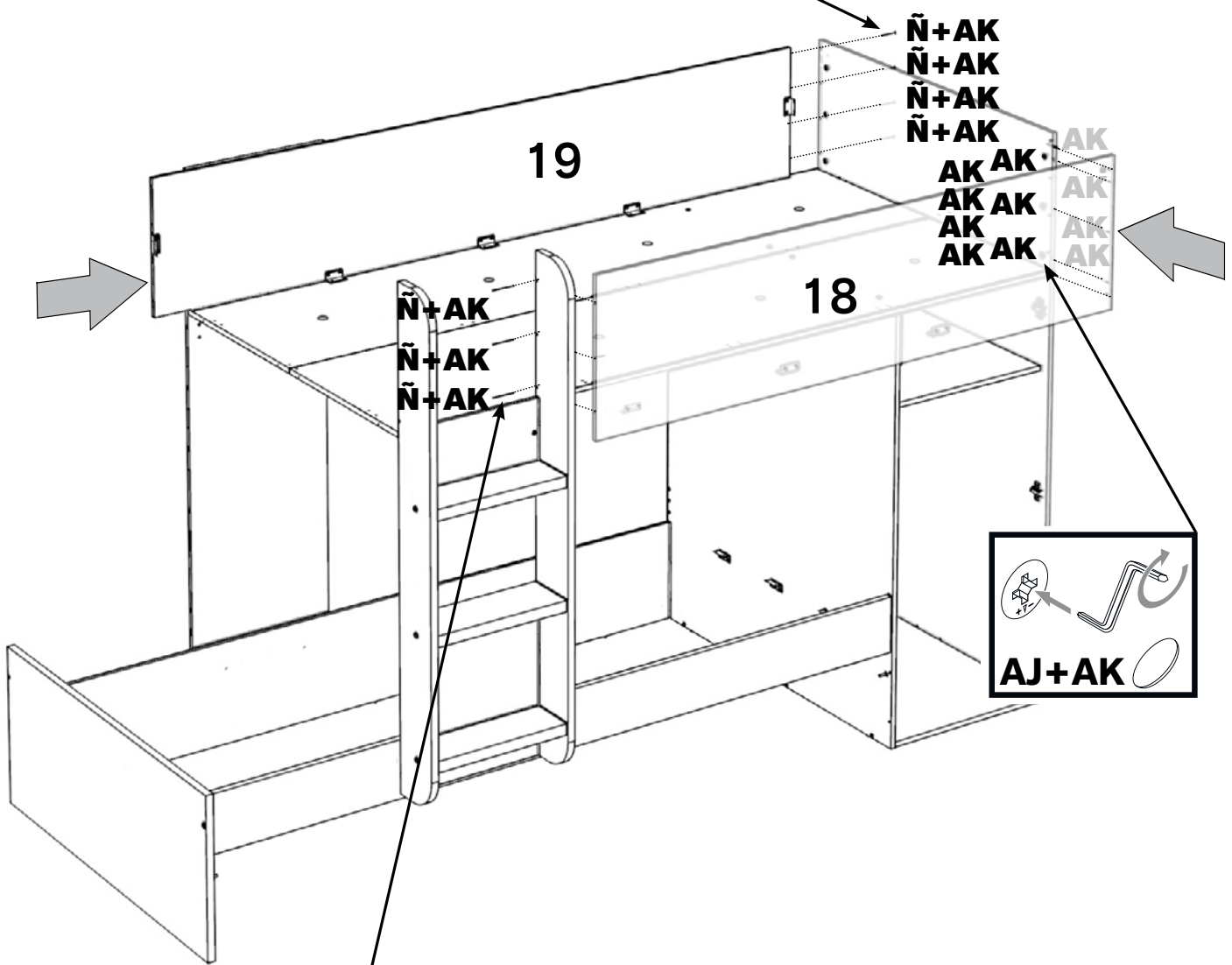

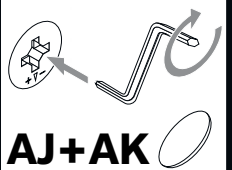

Option B

$\tilde{N}+AI+AK$

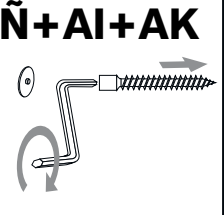

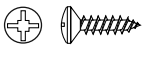

$AJ+AK$





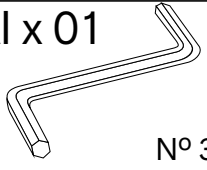
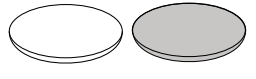

$\tilde{N}+AI+AK$

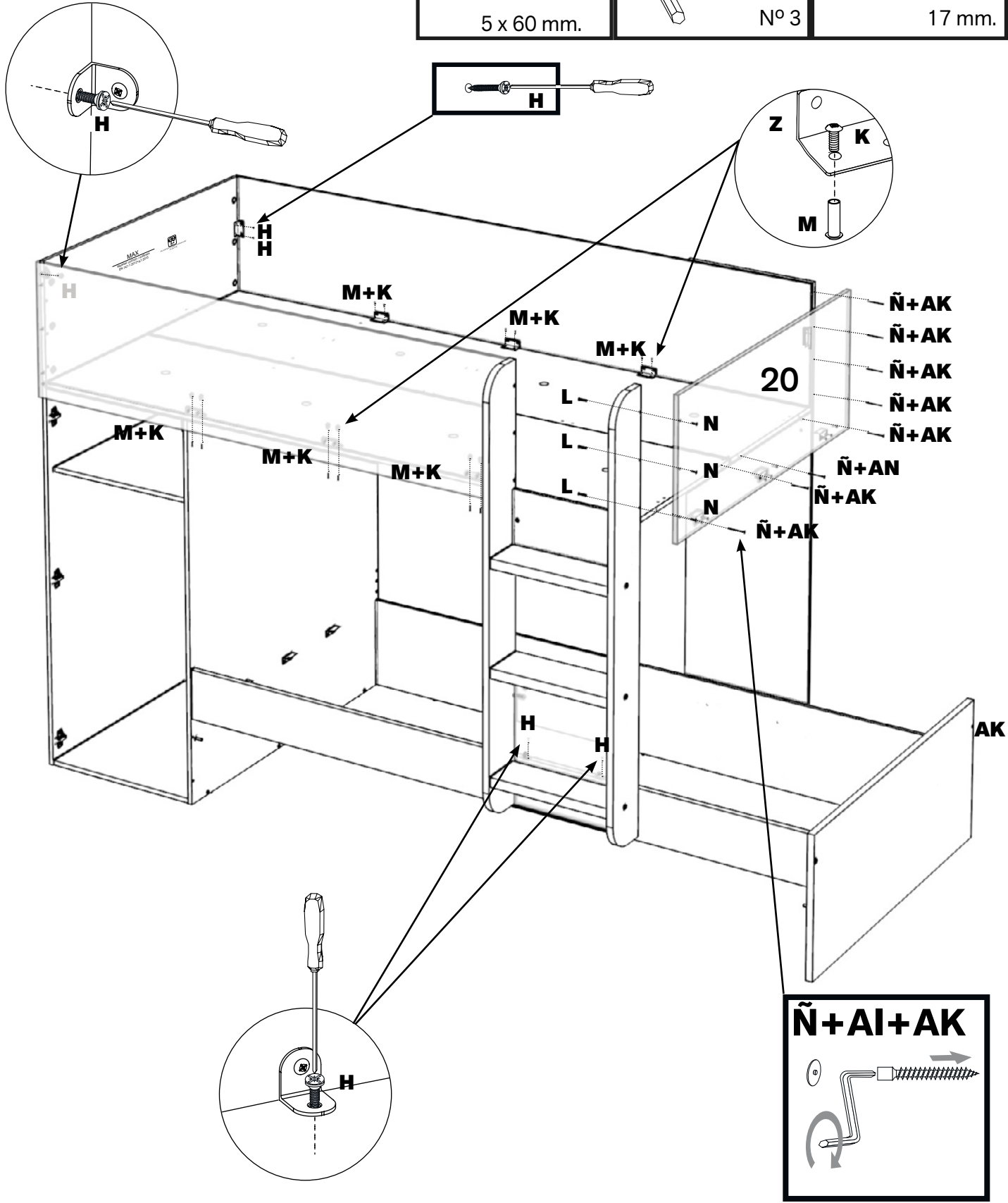
27 H x 05  4 x 16 mm.	K x 12  M4 x 10 mm.	L x 03  M4 x 15 mm.	M x 12  M4 x 15 mm.	N x 03  M4 x 29 mm.
---	--	--	--	--

Option A

Ñ x 08  5 x 60 mm.	AI x 01  Nº 3	AK x 09  17 mm.
---	--	--



27 H x 05  4 x 16 mm.	K x 12  M4 x 10 mm.	L x 03  M4 x 15 mm.	M x 12  M4 x 15 mm.	N x 03  M4 x 29 mm.
---	--	--	--	--

Option B

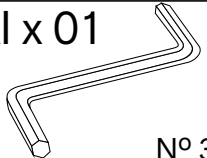
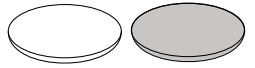
\tilde{N} x 08  5 x 60 mm.	AI x 01  Nº 3	AK x 09  17 mm.
---	--	--

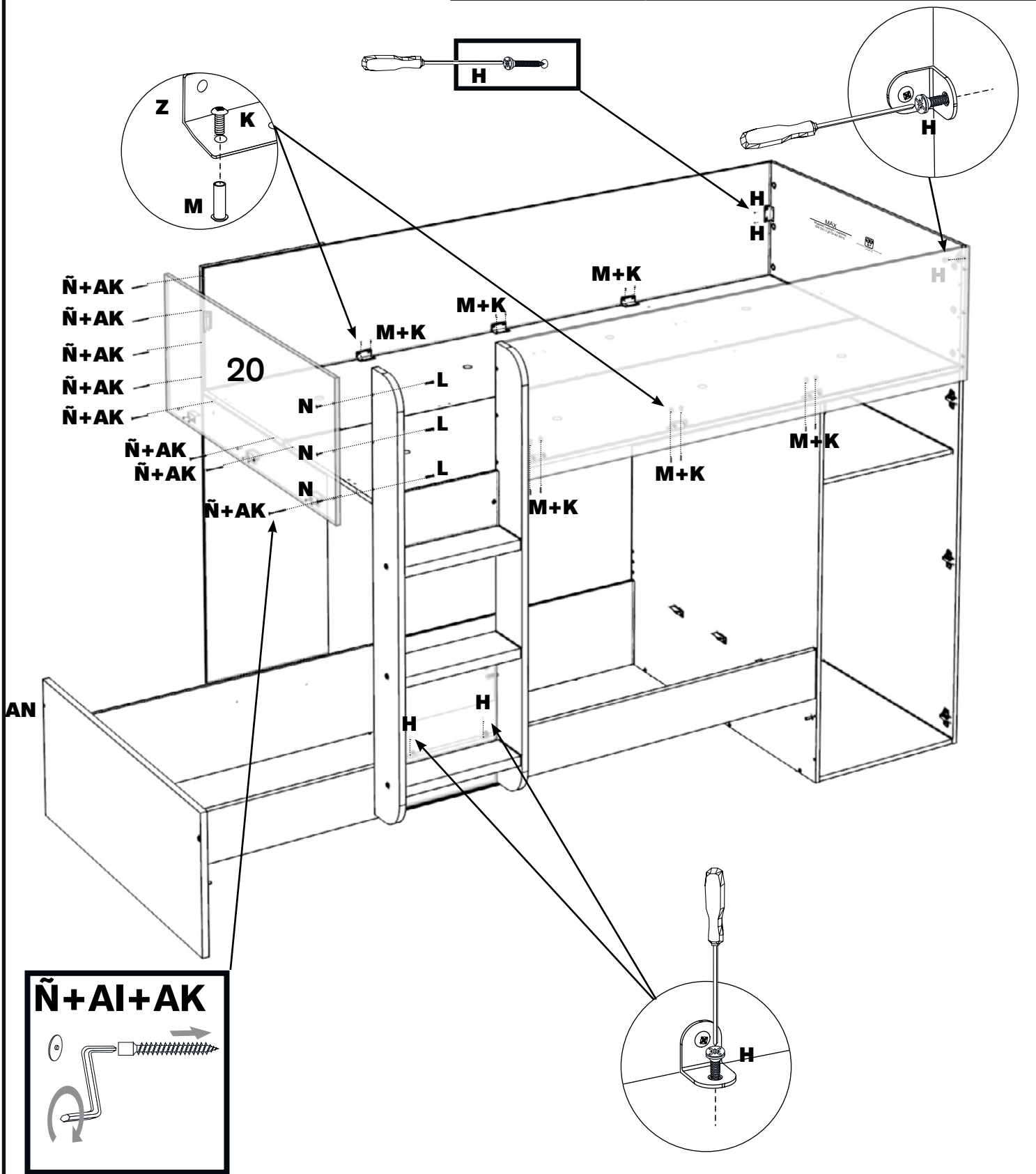

28

H x 12

AB x 03



4 x 16 mm.

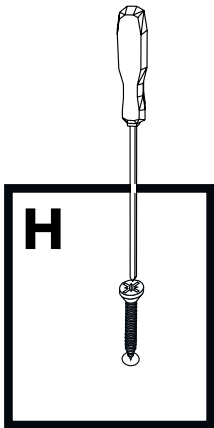
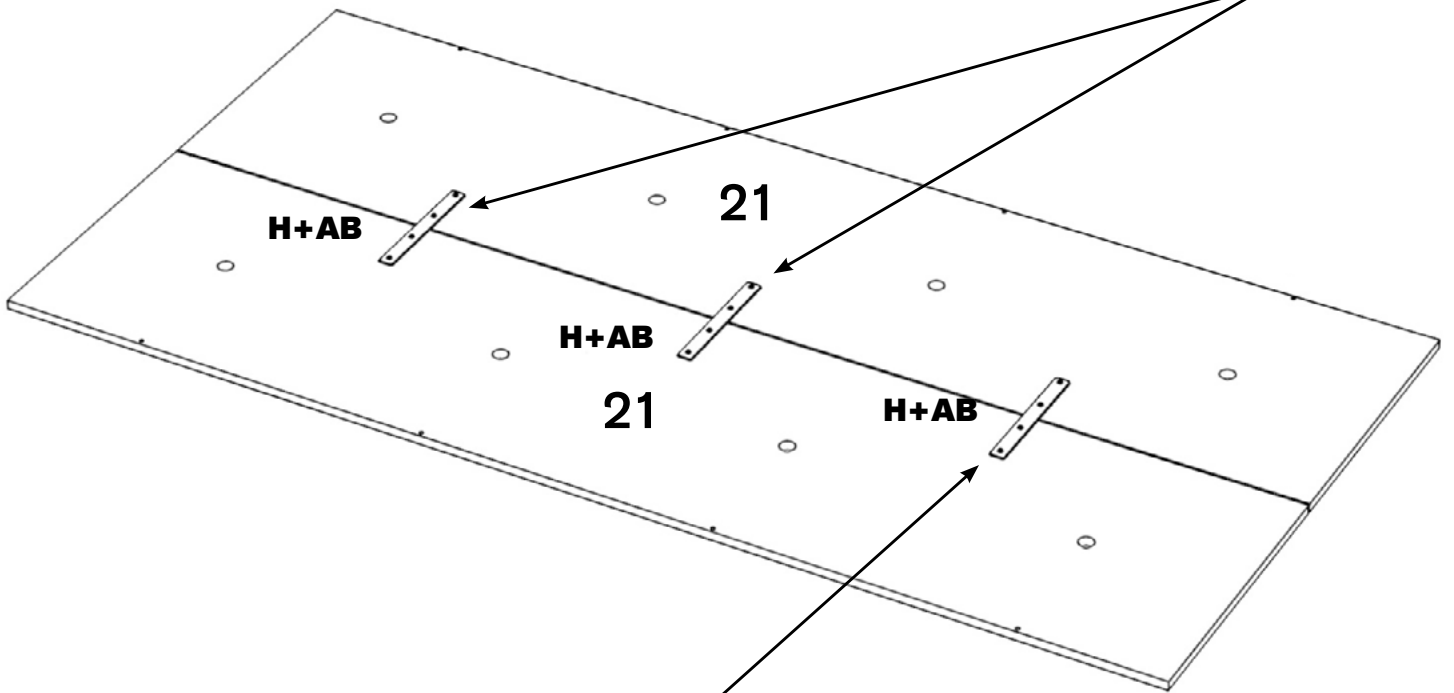
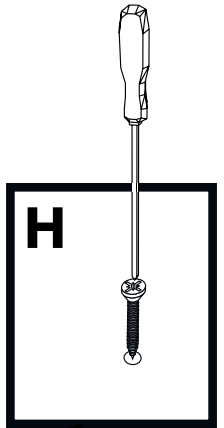
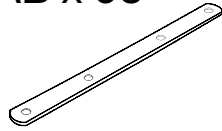

29

G x 02

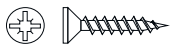

3.5 x 15 mm.

J x 04

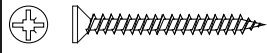

4.5 x 30 mm.

K x 06

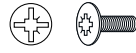

M4 x 10 mm.

M x 06



M4 x 15 mm.

Ñ x 04



5 x 60 mm.

H x 10

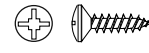

4 x 16 mm.

Al x 01

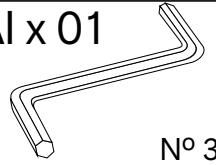

Nº 3

Option A

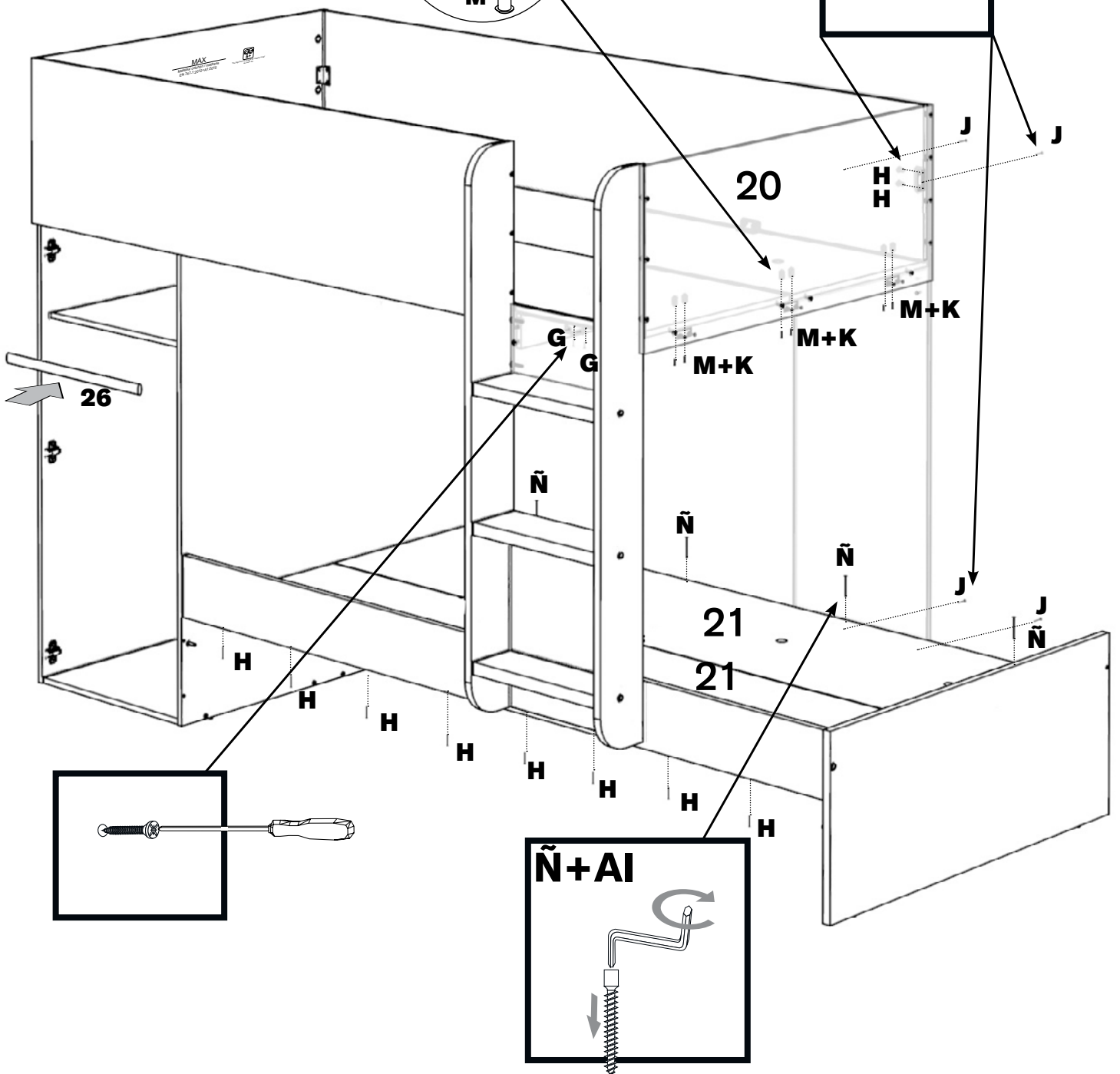
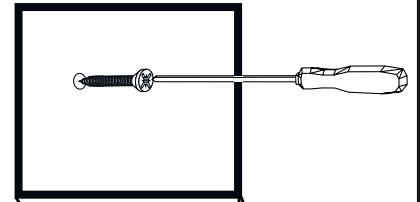
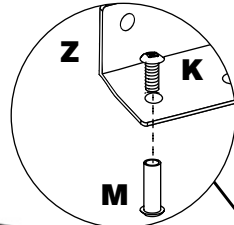

29

G x 02



3.5 x 15 mm.

J x 04

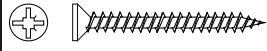

4.5 x 30 mm.

K x 06



M4 x 10 mm.

M x 06



M4 x 15 mm.

Ñ x 04



5 x 60 mm.

H x 10

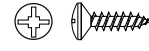

4 x 16 mm.

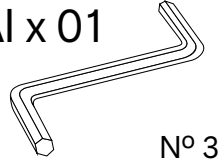

AI x 01

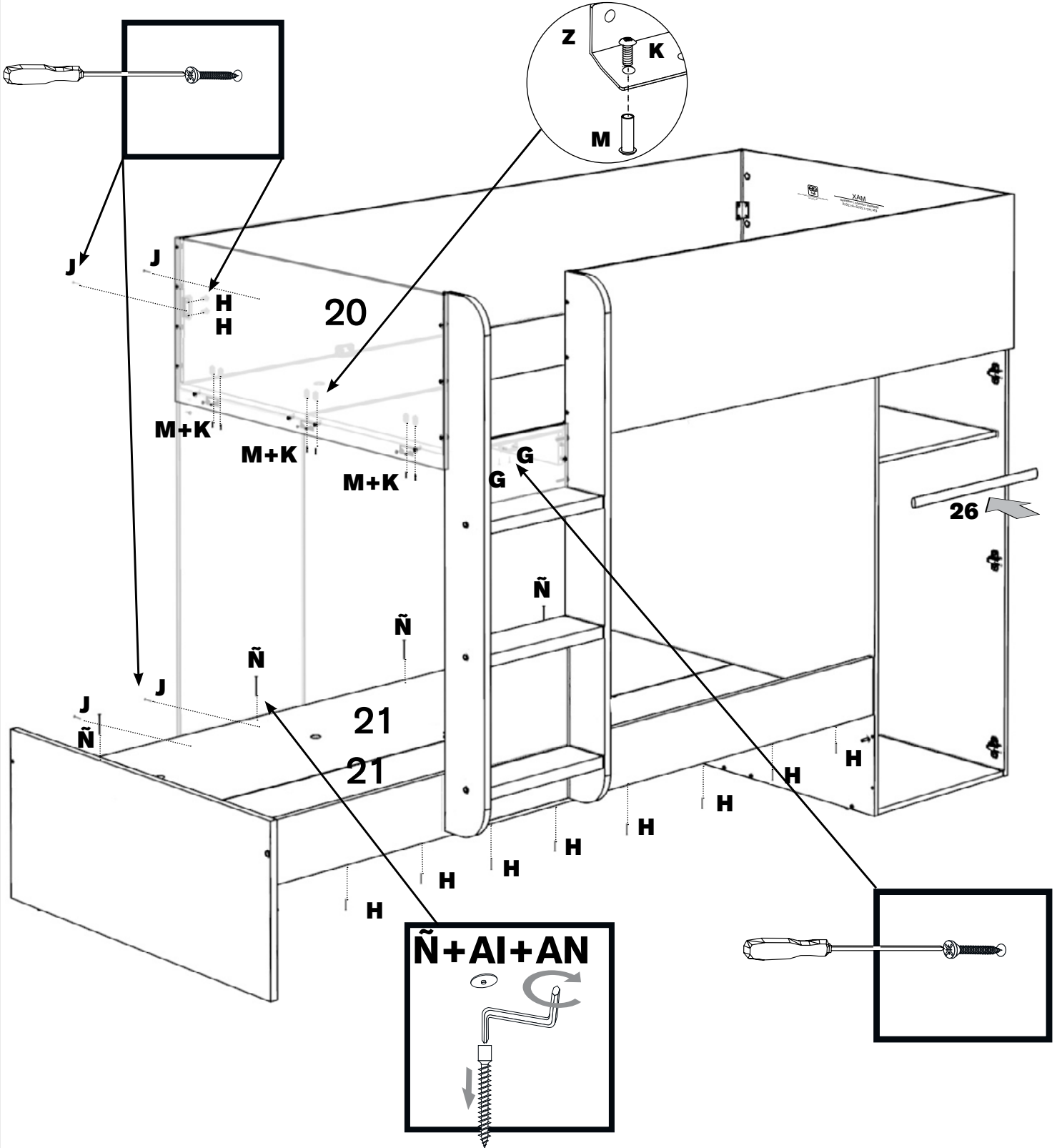

Nº 3

Option B

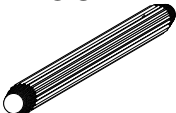
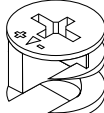
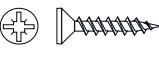
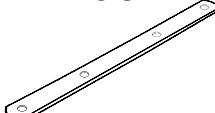

30	C x 05 	F x 06 	G x 16  3.5 x 15 mm.	AB x 03 	AH x 08 
----	---	---	---	--	--

H x 12

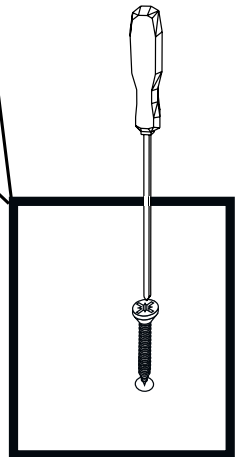
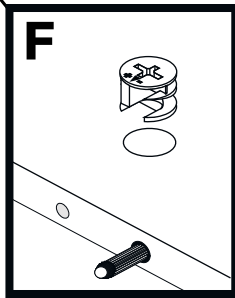
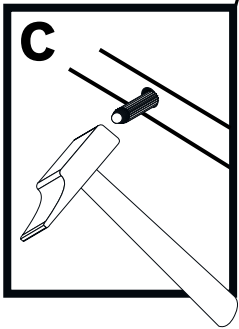
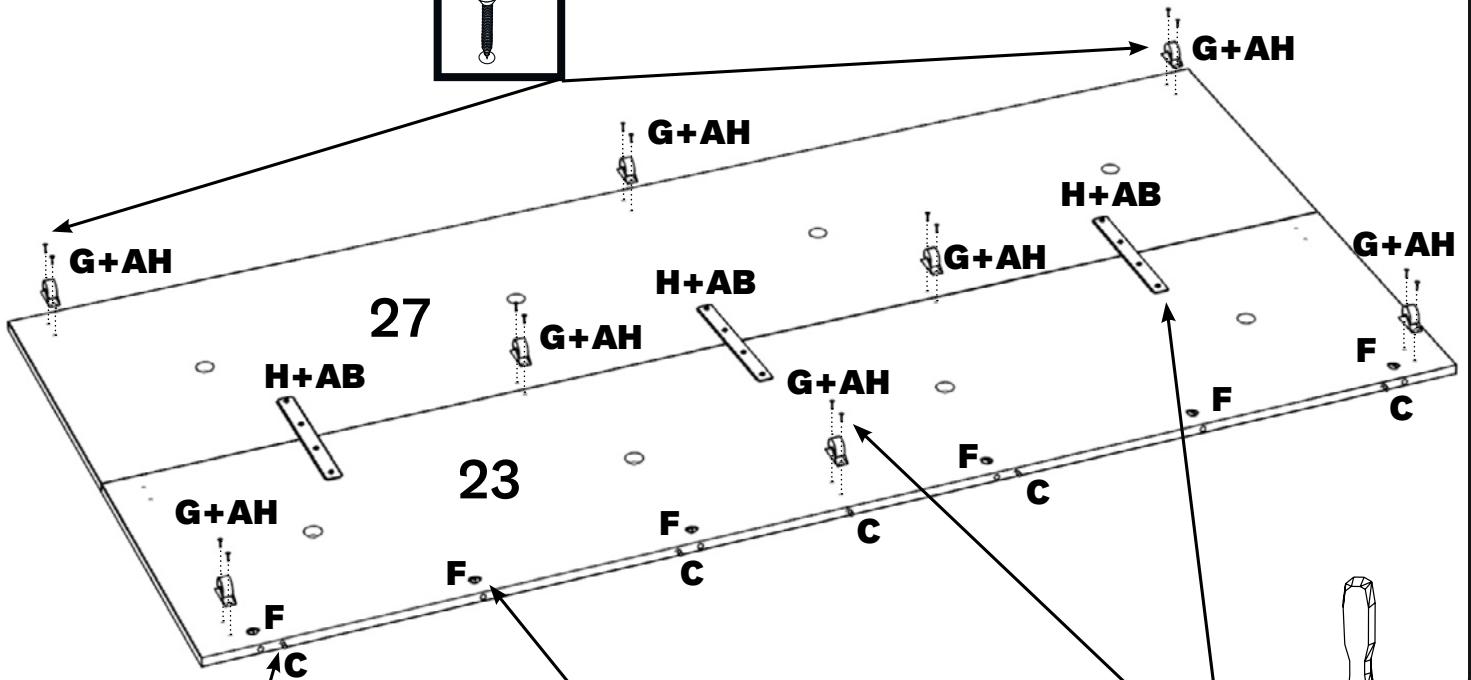
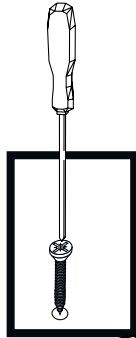
4 x 16 mm.

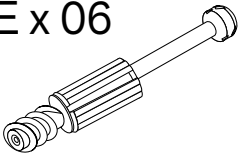

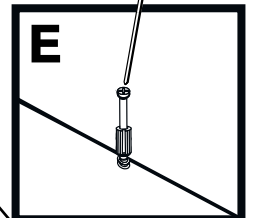
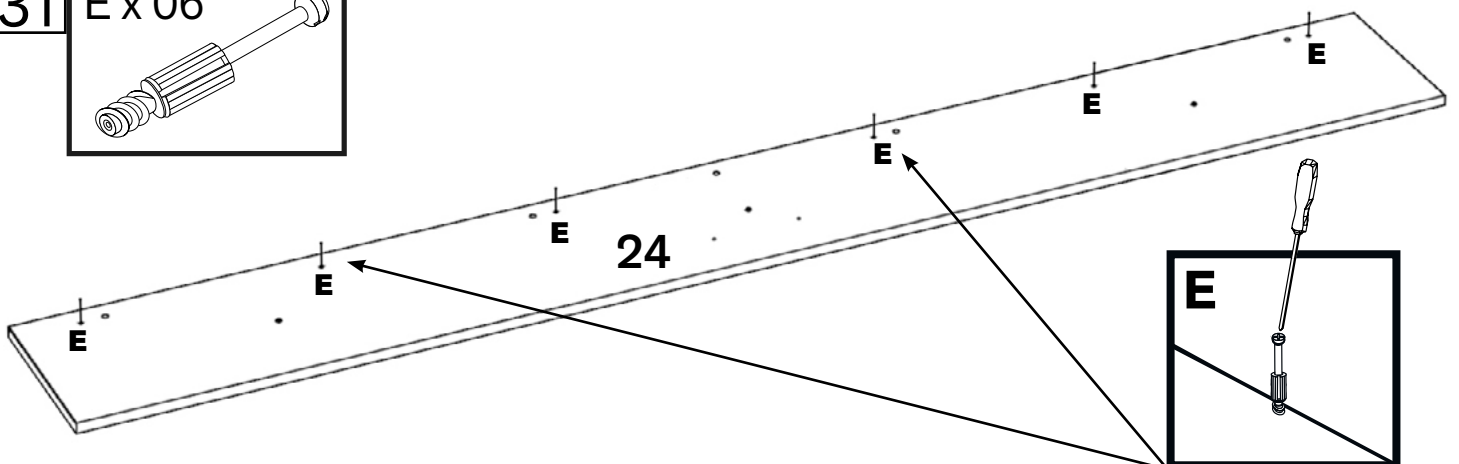
31 E x 06

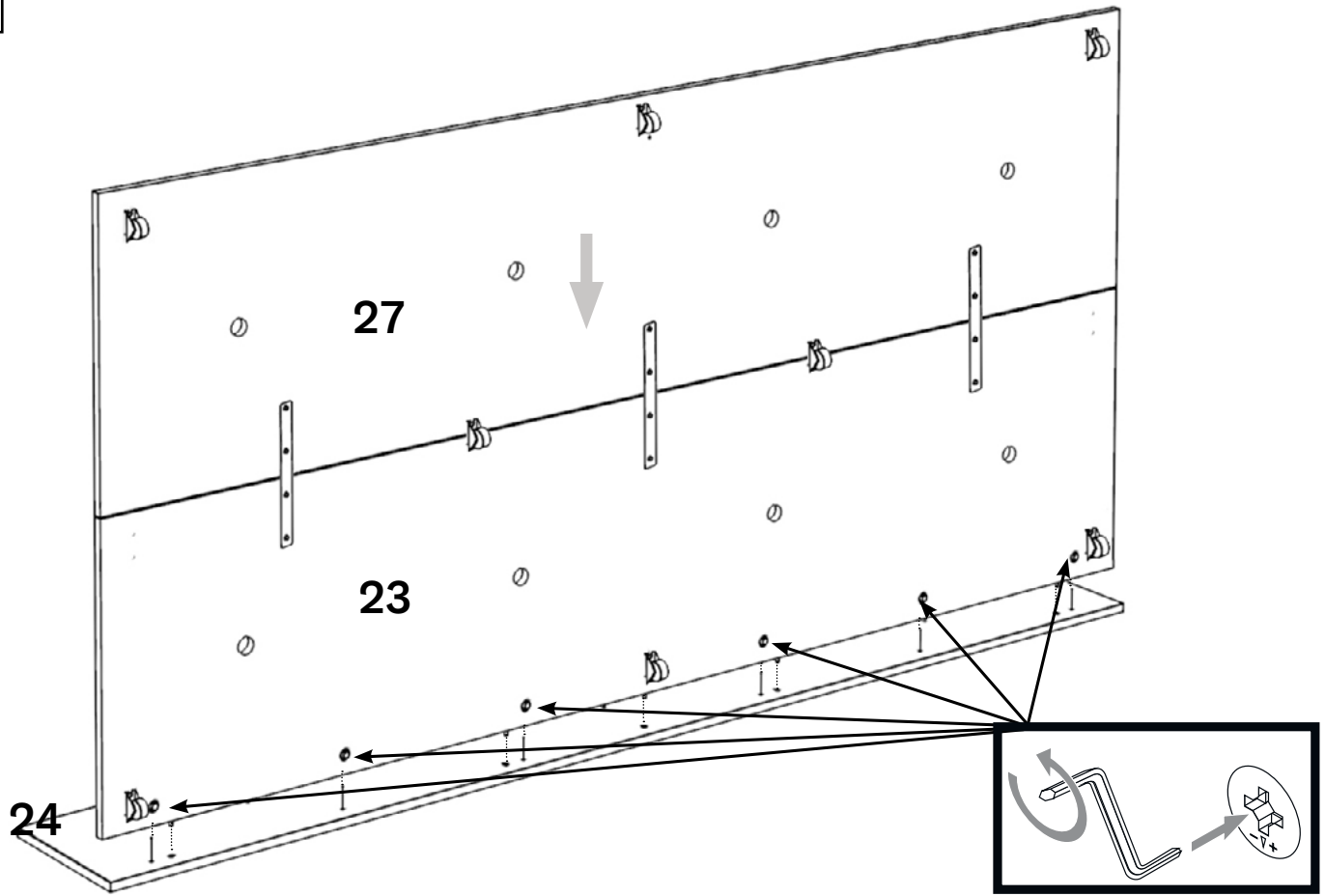

32



33

G x 18

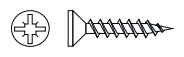

3.5 x 15 mm.

AC x 03

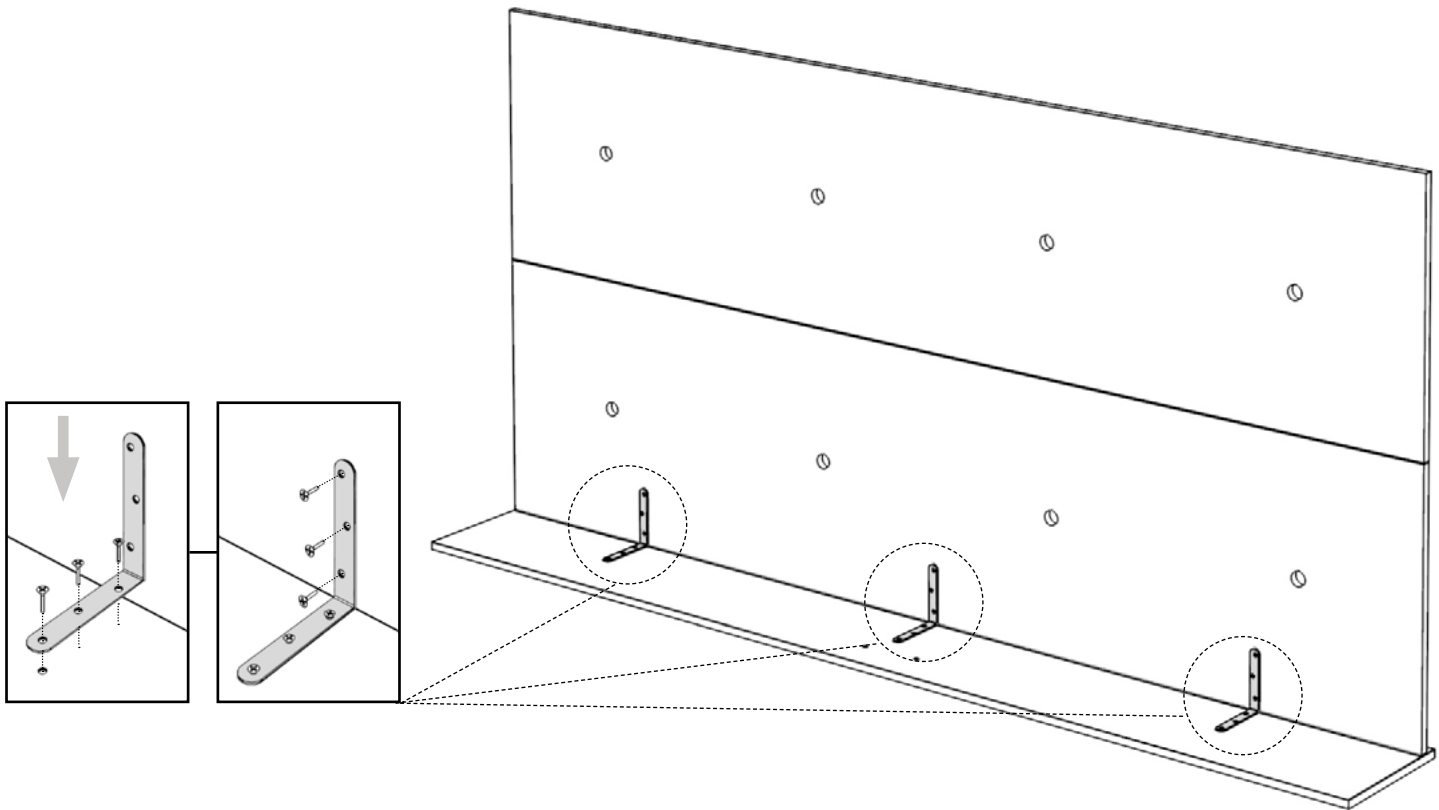
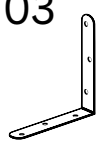

34

A x 03

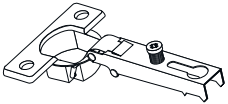

G x 06



3.5 x 15 mm.

AL x 02



7 mm.

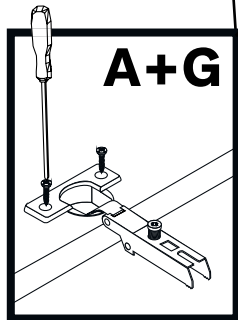
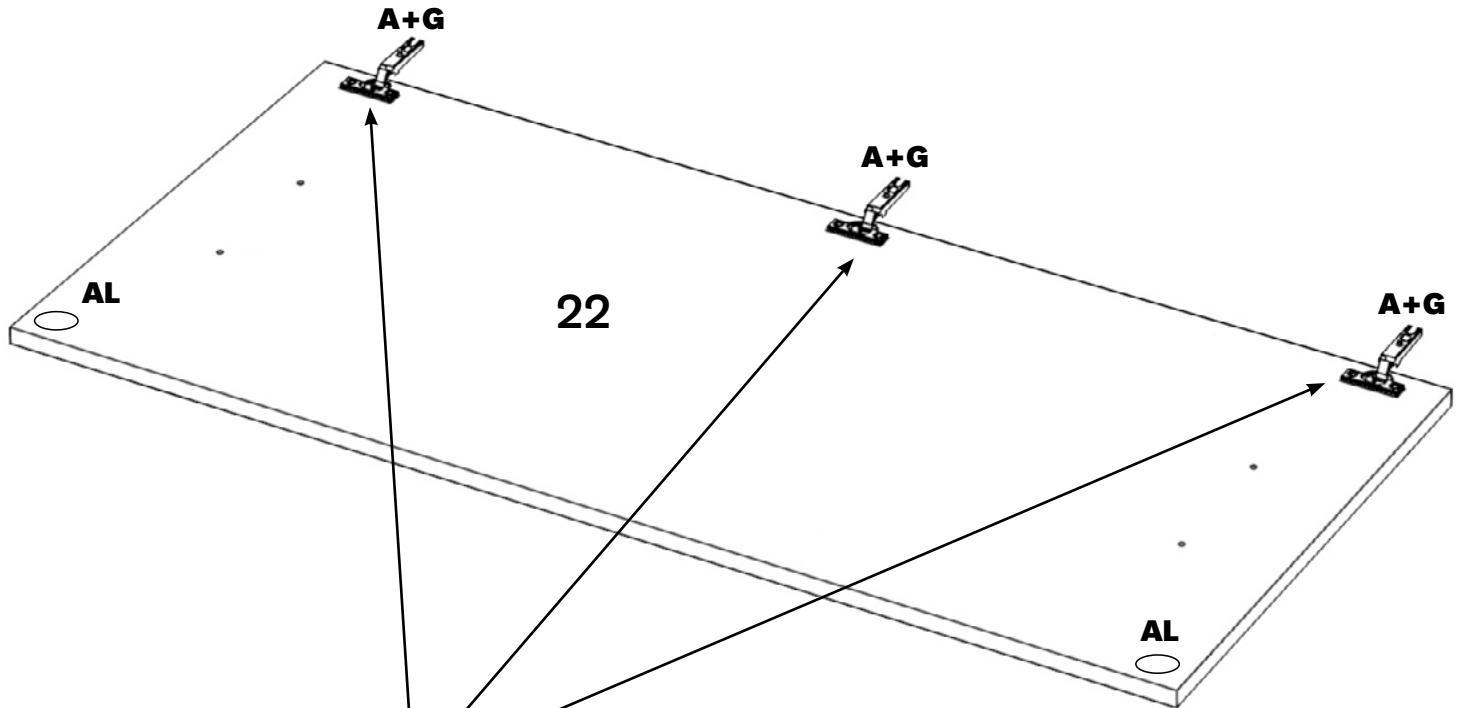

35

I x 04

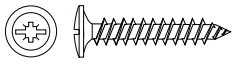

4 x 27 mm.

U x 02



Option A

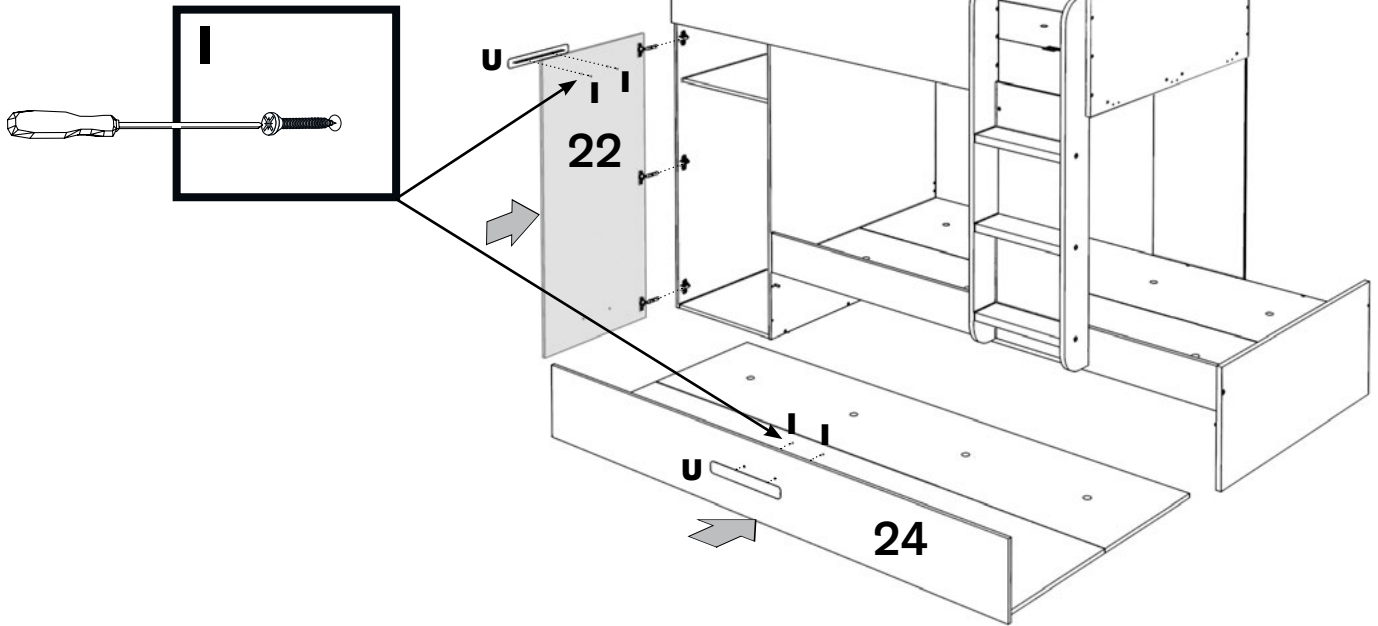

Option B

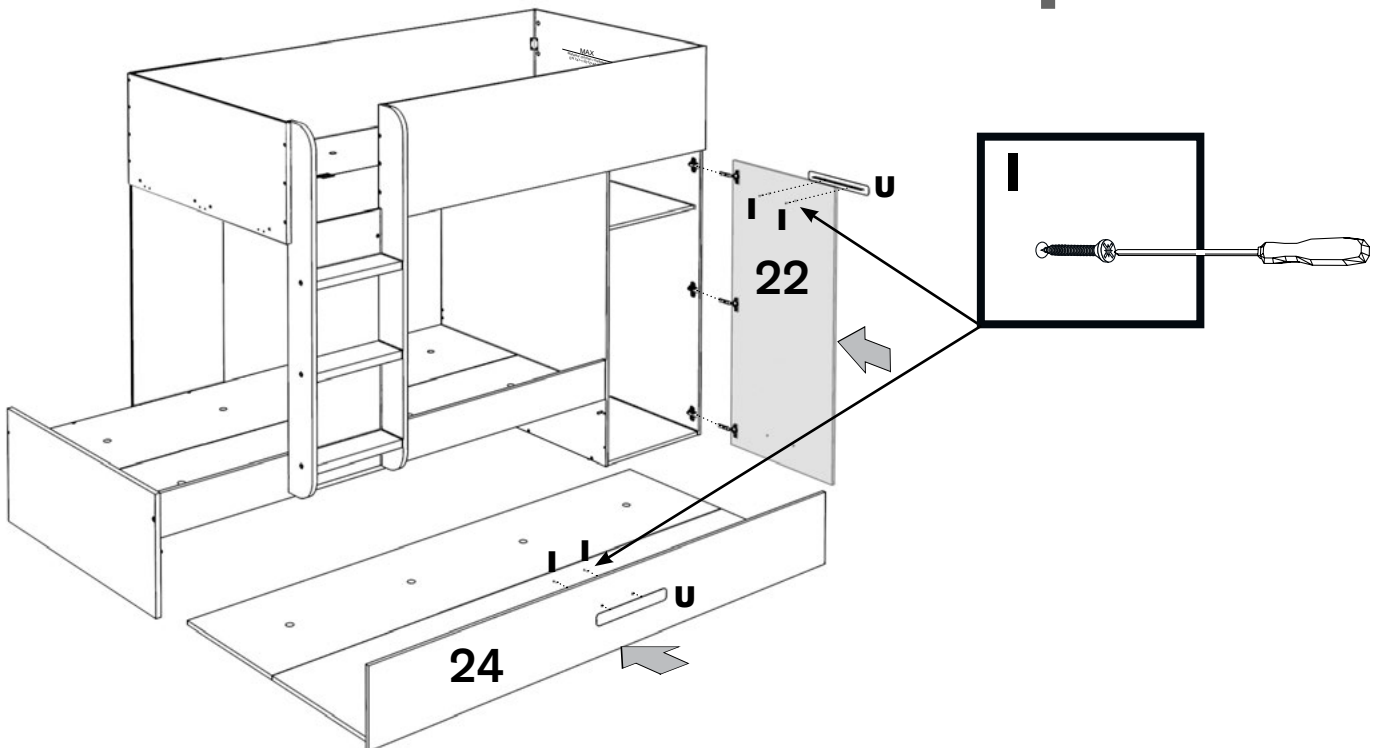

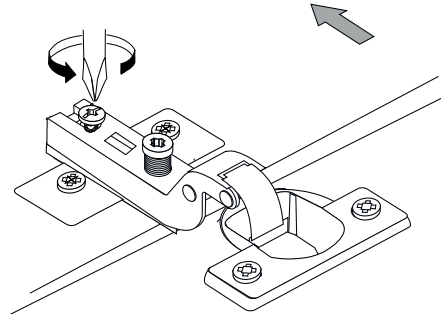
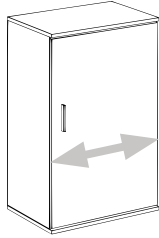

1°

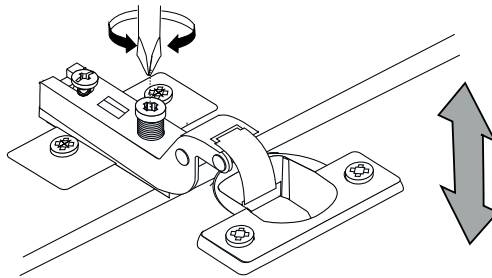

2°

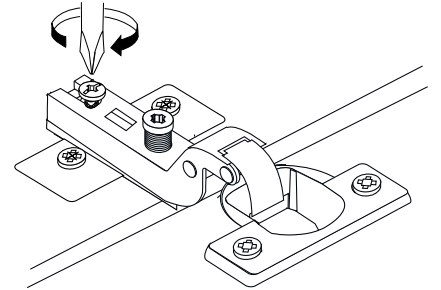

3°

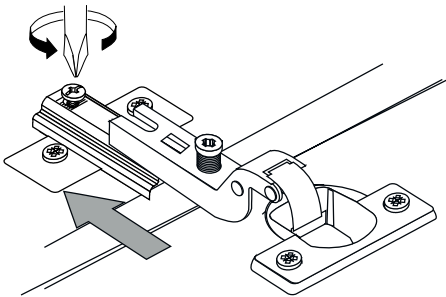
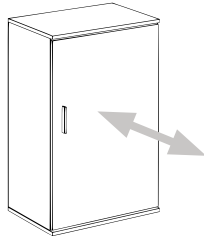

1°

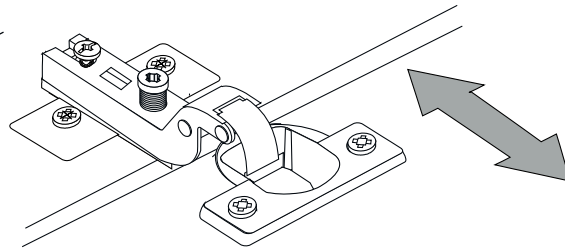

2°

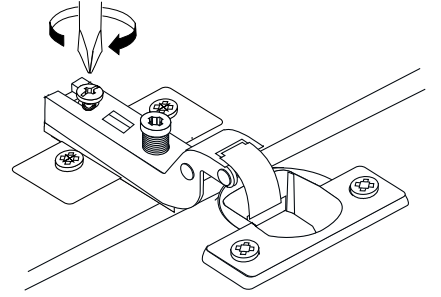

3°

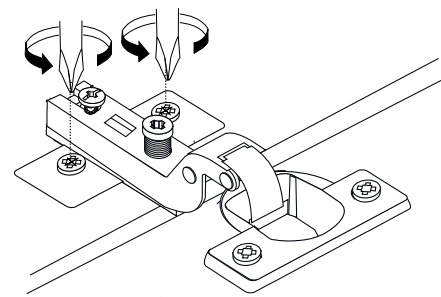
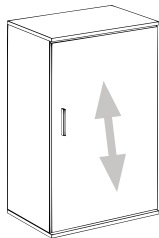

1°

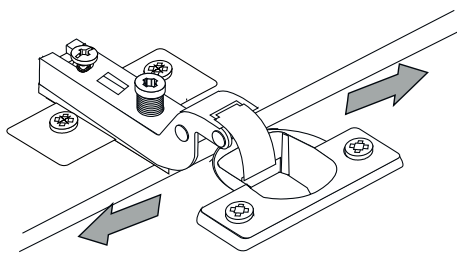

2°

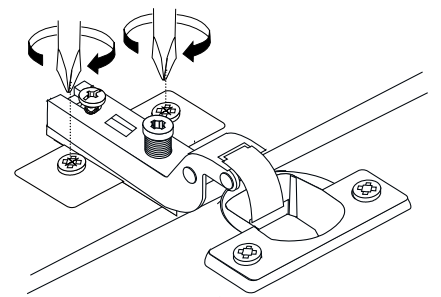

3°

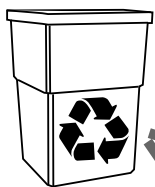

PLÁSTICO / PLASTIC
PLASTIQUE / PLÁSTICO
PLASTICA / PLASTIK
PLASTIKOWY

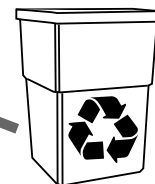
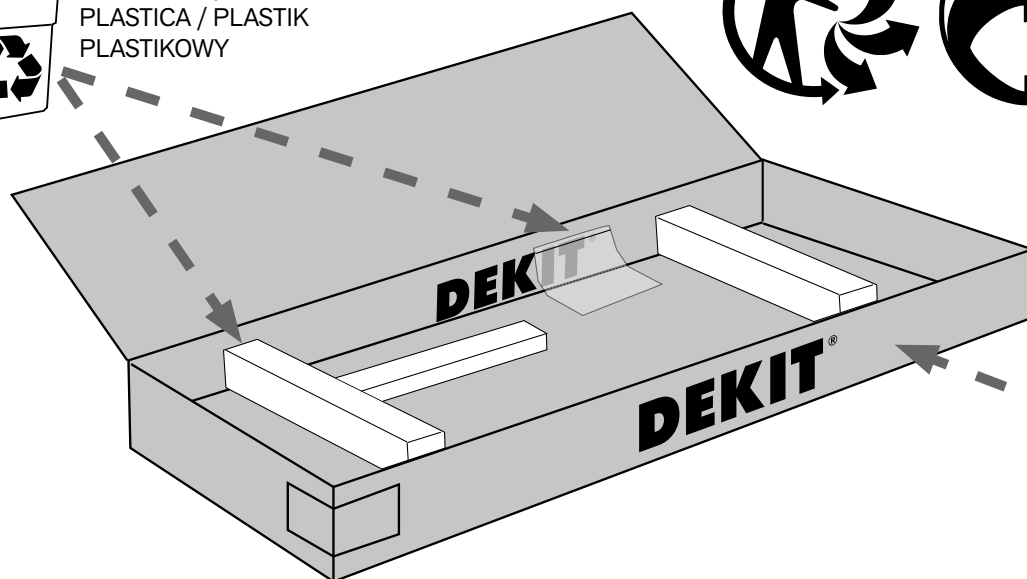
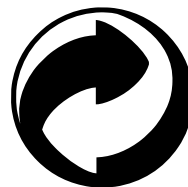

CARTÓN / CARDBOARD
CARTON / CARTÃO
CARTONE / KARTON



Adresses sur quefairedemesdechets.fr

GARANTÍA-WARRANTY-GARANTIE-GARANTIA-GARANZIA-GWARANCJA

ES

Distribuido por VENTE-UNIQUE.COM Dirección: 9 Rue Jacquart 93310 Le Pré-Saint-Gervais FRANCIA. Email: gpsr@vente-unique.com. Garantía de 3 años a partir fecha compra contra todo defecto de fabricación del producto. La garantía no incluye los defectos de mal montaje o mal uso del mueble.

Para cualquier defecto en el mueble o dificultades durante el montaje, por favor contacte con el establecimiento o sitio web donde compró el mueble.

Es necesario conservar el ticket de compra y el N° de Control de Calidad en caso de consulta o reclamación.

EN

Distributed by VENTE-UNIQUE.COM Address: 9 Rue Jacquart 93310 Le Pré-Saint-Gervais FRANCE. Email: gpsr@vente-unique.com. Guarantee of 3 years from the date of purchase against any manufacturing defect of the product. The guarantee does not include defects during the assembly or misuse of the furniture.

For any furniture defect of any difficulties during the assembly, please contact with the store or website where you purchased the furniture.

It is necessary to keep the purchase ticket and the Quality Control N° in case of any question or claim.

FR

Distribué par VENTE-UNIQUE.COM Adresse: 9 Rue Jacquart 93310 Le Pré-Saint-Gervais FRANCE. Email: gpsr@vente-unique.com. Garantie de 3 ans à compter de la date d'achat contre tout défaut de fabrication du produit. La garantie ne couvre pas les défauts dus à un mauvais montage ou à une mauvaise utilisation du meuble.

Pour tout défaut du meuble ou difficultés lors du montage, veuillez contacter le magasin ou la web où vous avez acheté le meuble.

Il est nécessaire de conserver la facture d'achat et le numéro de contrôle qualité en cas de demande d'information ou de réclamation.

PT

Distribuído por VENTE-UNIQUE.COM Endereço: 9 Rue Jacquart 93310 Le Pré-Saint-Gervais FRANÇA. Email: gpsr@vente-unique.com. Garantia de 3 anos a partir da data de compra contra qualquer defeito de fabricação do produto. A garantia não inclui defeitos decorrentes de má montagem ou mau uso do móvel.

Para qualquer defeito nos móveis ou dificuldades durante a montagem, entre em contato com a loja ou site onde comprou os móveis.

É necessário guardar o talão de compra e indicar o N° do Controle de Qualidade ao consultar ou reclamar.

IT

Distribuito da VENTE-UNIQUE.COM Indirizzo: 9 Rue Jacquart 93310 Le Pré-Saint-Gervais FRANCE. Email: gpsr@vente-unique.com. Garanzia 3 anni dalla data di acquisto contra qualsiasi difetto di fabbricazione del prodotto La garanzia non coprende i difetti dovuti al montaggio inadeguato o all'uso improprio dei mobili.

Per qualsiasi difetto del mobile o difficoltà durante il montaggio, si prega di contattare il negozio o il sito Web in cui è stato acquistato il mobile.

È necessario conservare il biglietto di acquisto e fornire il N° di Controllo Qualità in fase di consultazione o reclamo.

DE

Vertrieben von VENTE-UNIQUE.COM Indirizzo: 9 Rue Jacquart 93310 Le Pré-Saint-Gervais FRANCE. Email: gpsr@vente-unique.com. 3 Jahre Garantie ab Kaufdatum gegen Herstellungsfehler des Produkts. Die Garantie umfasst keine Mängel bei der Montage oder unsachgemäßer Verwendung der Möbel.

Bei Mängeln an den Möbeln oder Schwierigkeiten bei der Montage wenden Sie sich bitte an das Geschäft oder die Website, bei der Sie die Möbel gekauft haben.

Für den Fall von Fragen oder Reklamationen müssen Sie den Kaufbeleg und die Qualitätskontrollnummer aufbewahren.

NL

Gedistribueerd door VENTE-UNIQUE.COM Indirizzo: 9 Rue Jacquart 93310 Le Pré-Saint-Gervais FRANKRIJK. Email: gpsr@vente-unique.com. Garantie van 3 jaar vanaf de aankoopdatum tegen elk fabricagefout van het product. De garantie omvat geen defecten tijdens de montage of verkeerd gebruik van het meubilair. Voor elk meubeldefect of eventuele moeilijkheden tijdens de montage, neem contact op met de winkel of website.

Bewaar de aankoopbon en het nummer van de kwaliteitscontrole voor vragen of klachten.

PL

Dystrybucja VENTE-UNIQUE.COM Indirizzo: 9 Rue Jacquart 93310 Le Pré-Saint-Gervais FRANCE. Email: gpsr@vente-unique.com. Gwarancja 3 lata od daty zakupu na wszelkie wady produkcyjne produktu. Gwarancja nie obejmuje wad powstałych podczas montażu lub niewłaściwego użytkowania mebli.

W przypadku jakichkolwiek wad mebli lub trudności podczas montażu prosimy o kontakt ze sklepem lub stroną internetową.

Konieczne jest zachowanie dowodu zakupu i numeru kontroli jakości na wypadek pytań lub reklamacji.

N° Control Calidad:

Quality Control N°:

N° Contrôle Qualité:

N° Controle Qualidade:

Controllo Qualità:

Qualitätskontrolle Nummer:

Kwaliteitscontrole Nummer:

N° kontroli jakości: