

# VALIRA

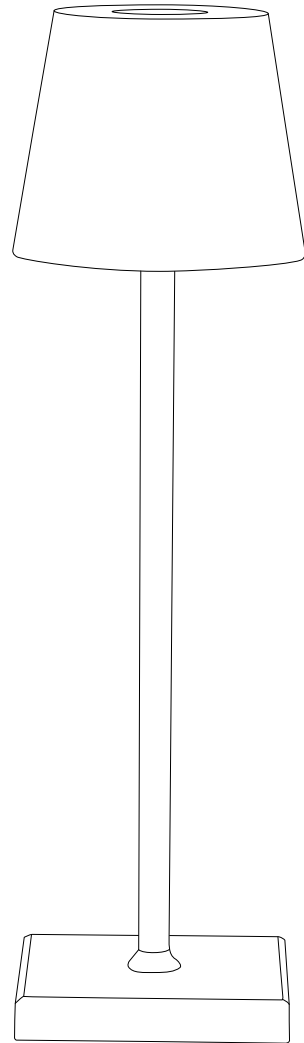

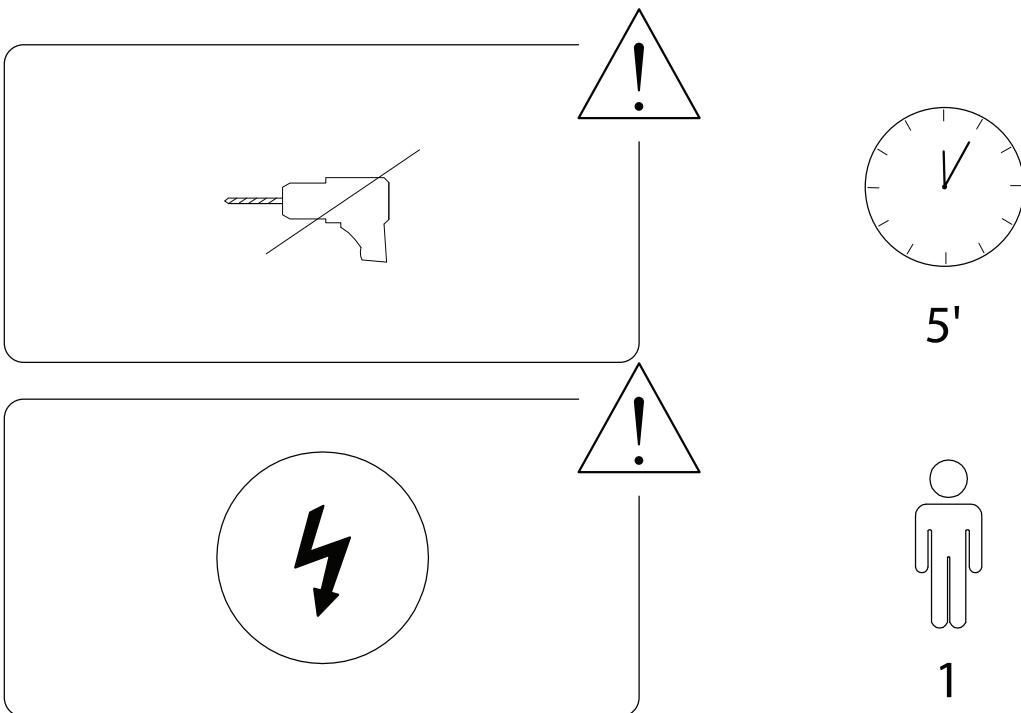

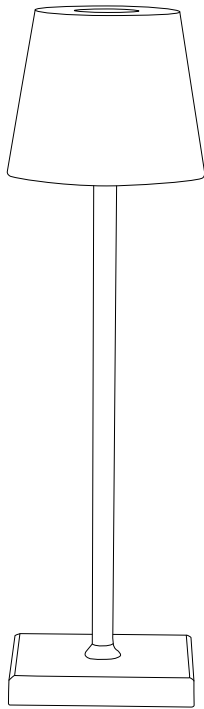
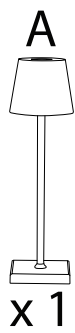
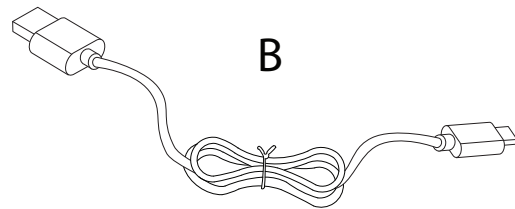
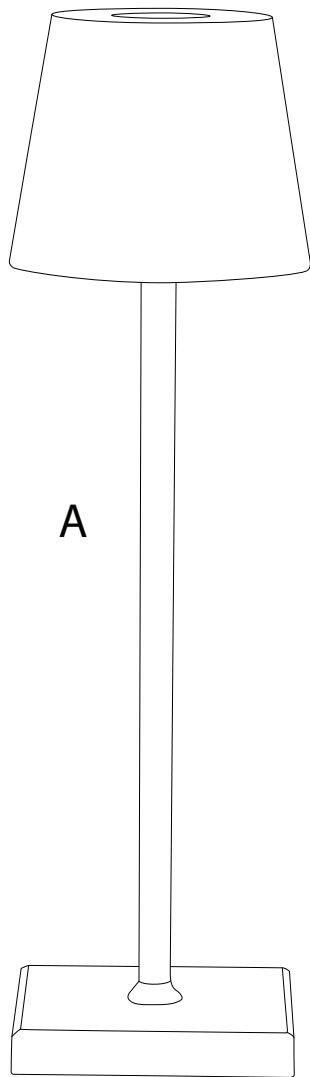

x 1

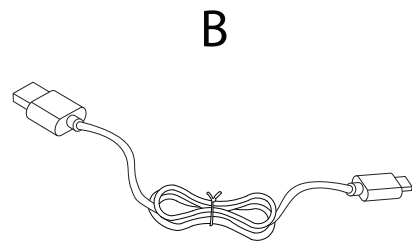

x 1

1

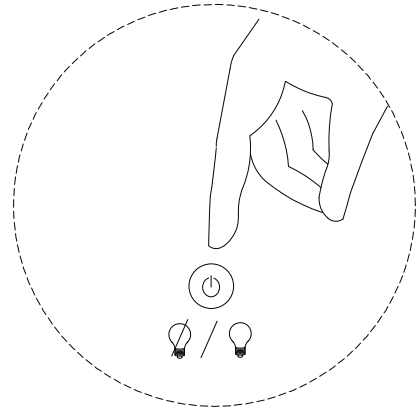
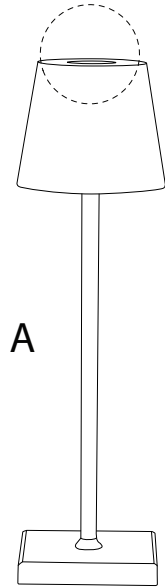

2

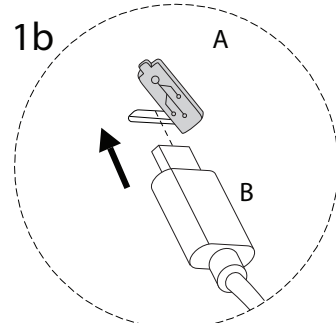
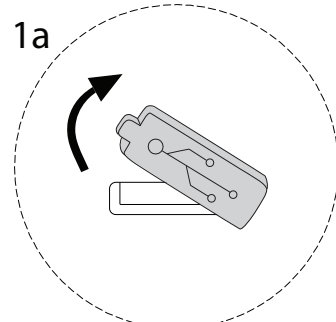
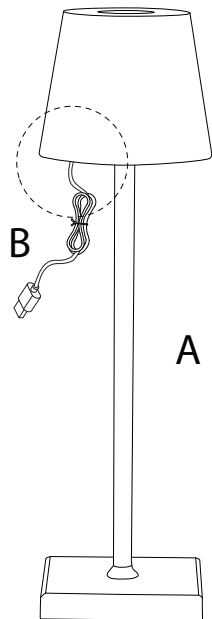
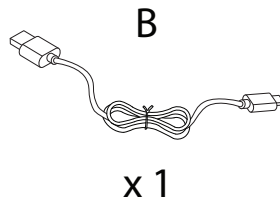

!

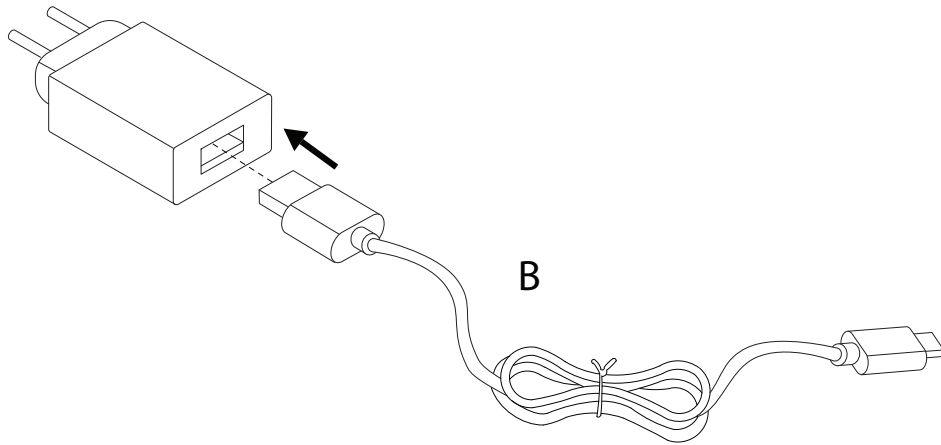

3

