

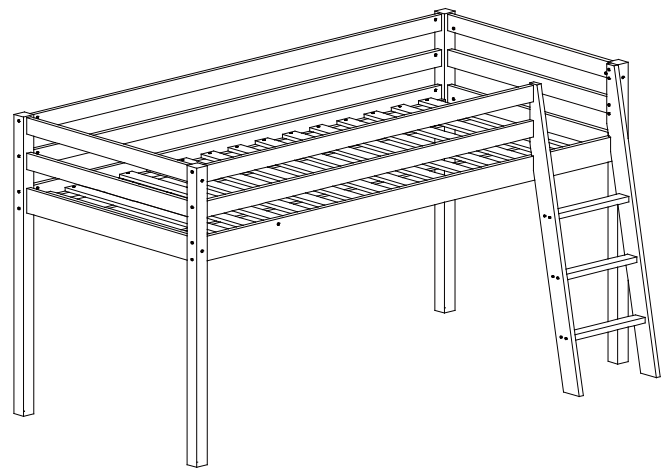









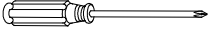





Version 1

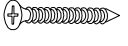

Version 2

HARDWARE



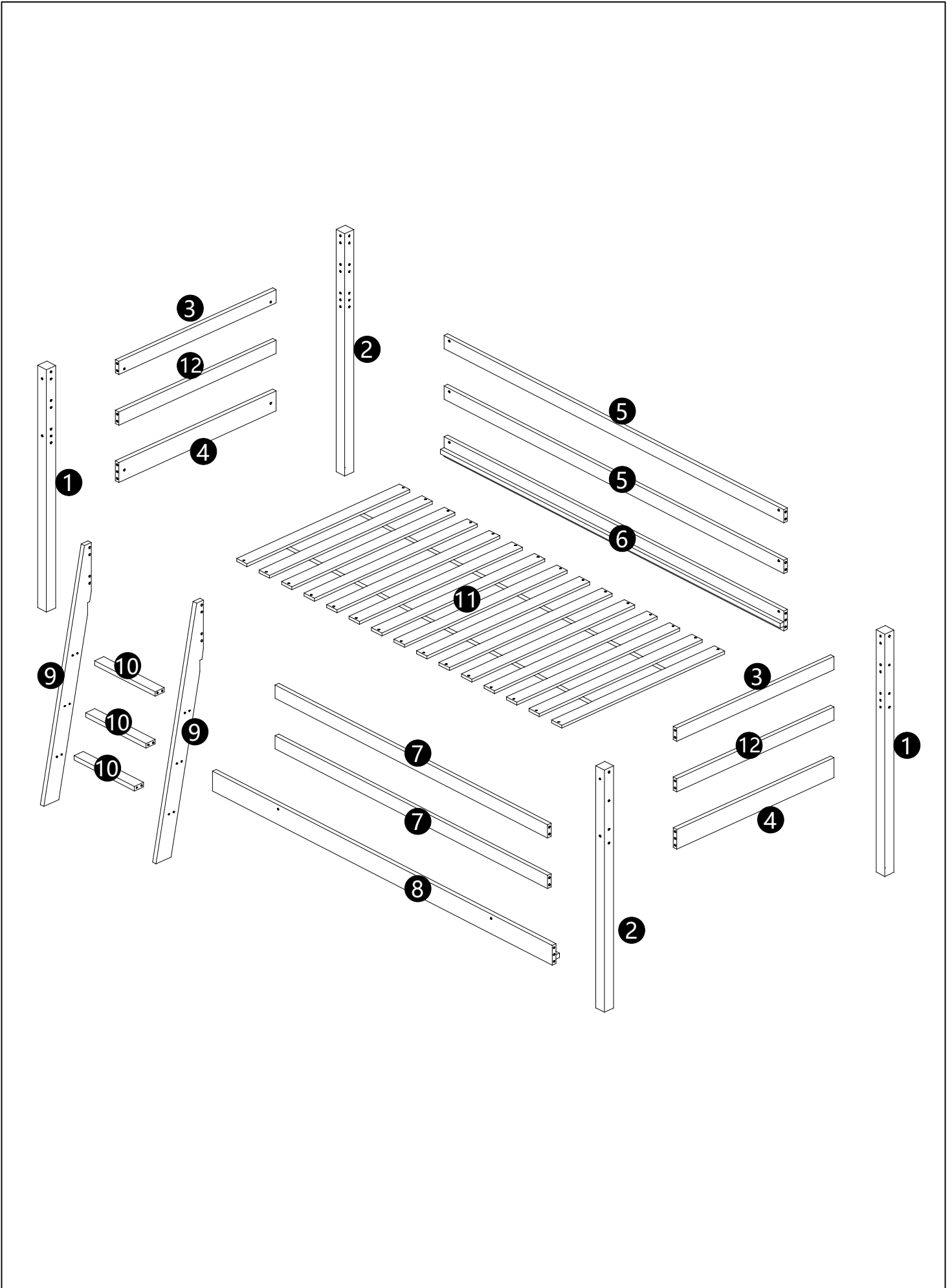

A	 15mm	 M6x90mm	22	G		1	
B		 Ø7x50mm	12	H	 15mm	 M6x60mm	4
C	 Ø10x13mm	24	J	 15mm	 M6x70mm	1	
D	 Ø8x30mm	34	K	 15mm	 M6x20mm	2	
E	 8mm	 Ø4x30mm	30	L		41	
F	 M4	2	M		5		

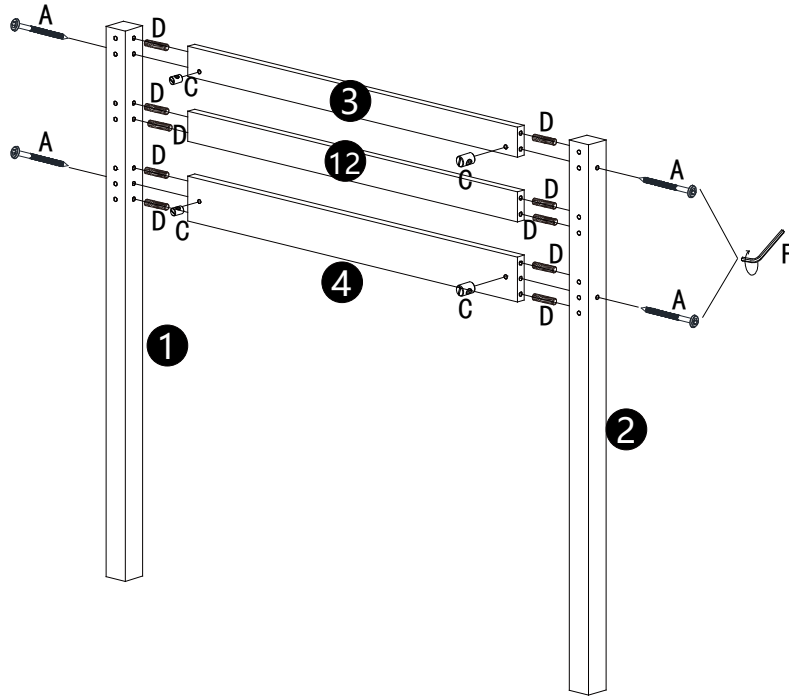

01

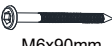



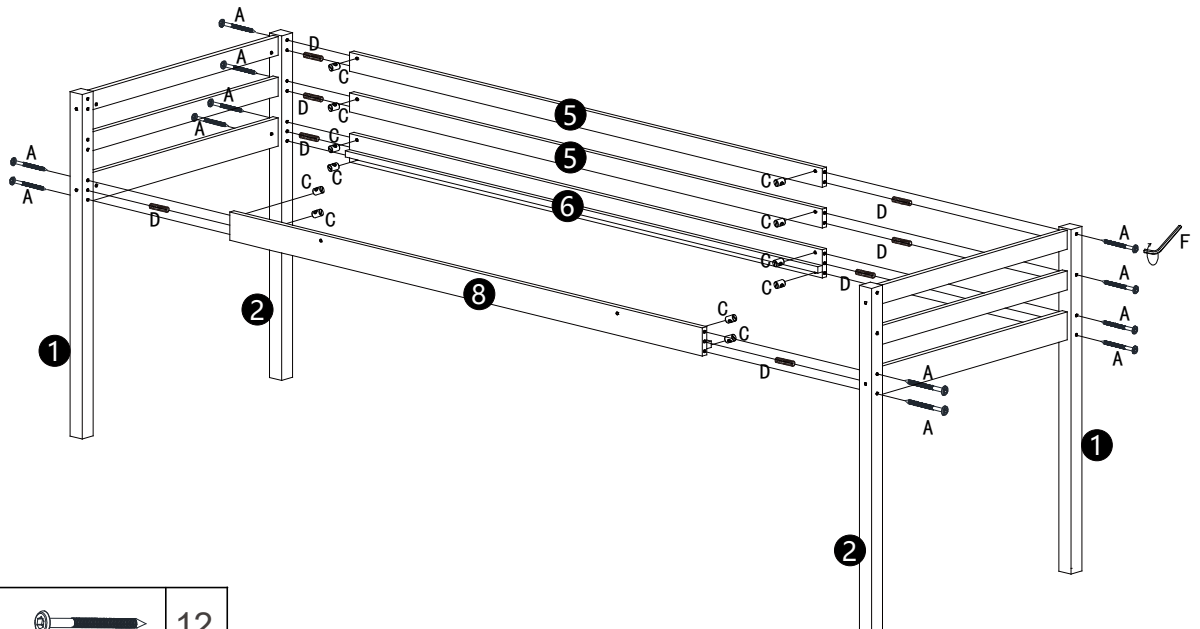

x 2

A	 15mm	 M6x90mm	8
C		$\varnothing 10 \times 13 \text{mm}$	8
D		$\varnothing 8 \times 30 \text{mm}$	20
F		M4	1





02

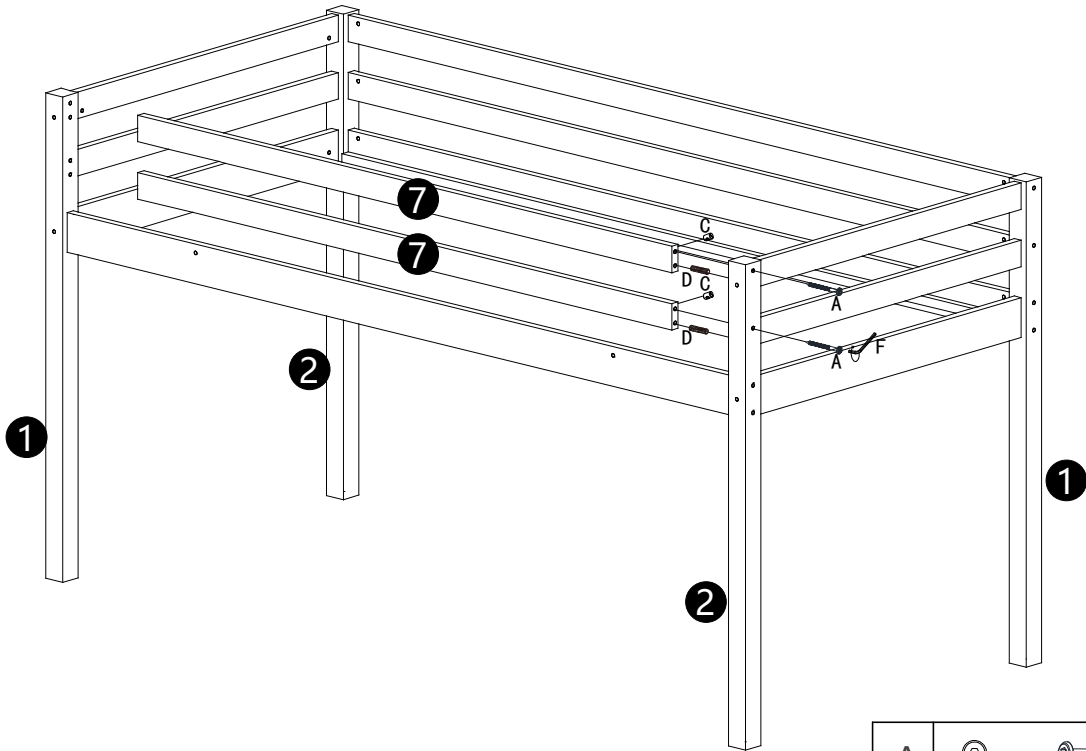

A	 15mm	 M6x90mm	12
C		$\varnothing 10 \times 13 \text{mm}$	12
D		$\varnothing 8 \times 30 \text{mm}$	8
F		M4	1

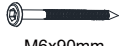

03



A	 15mm	 M6x90mm	2
C		Ø10x13mm	2
D		Ø8x30mm	2
F		M4	1

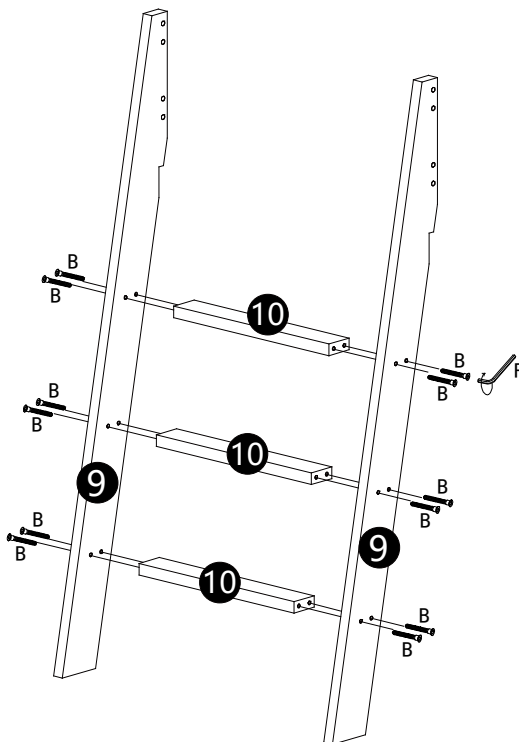





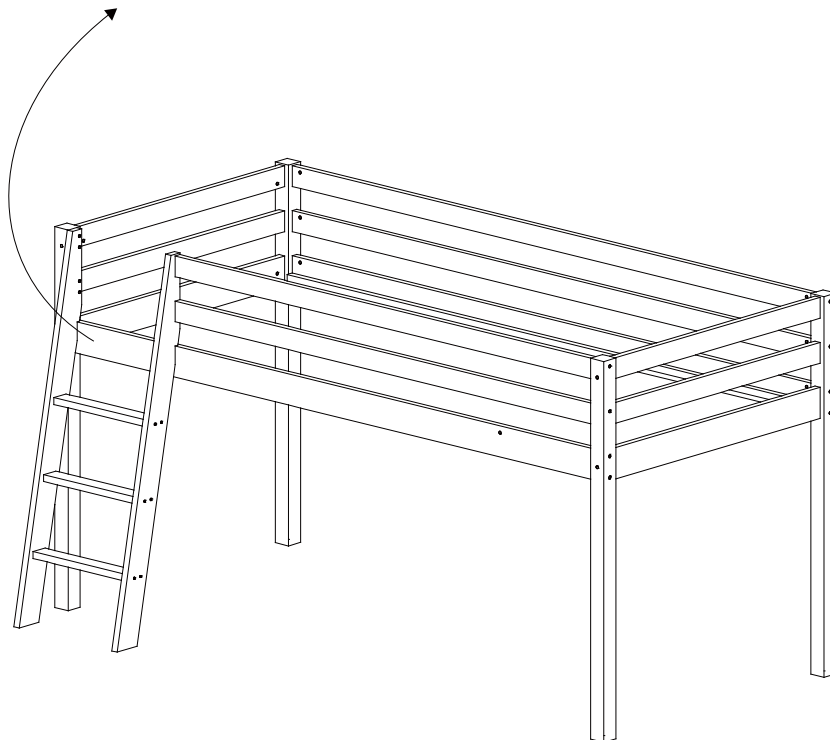
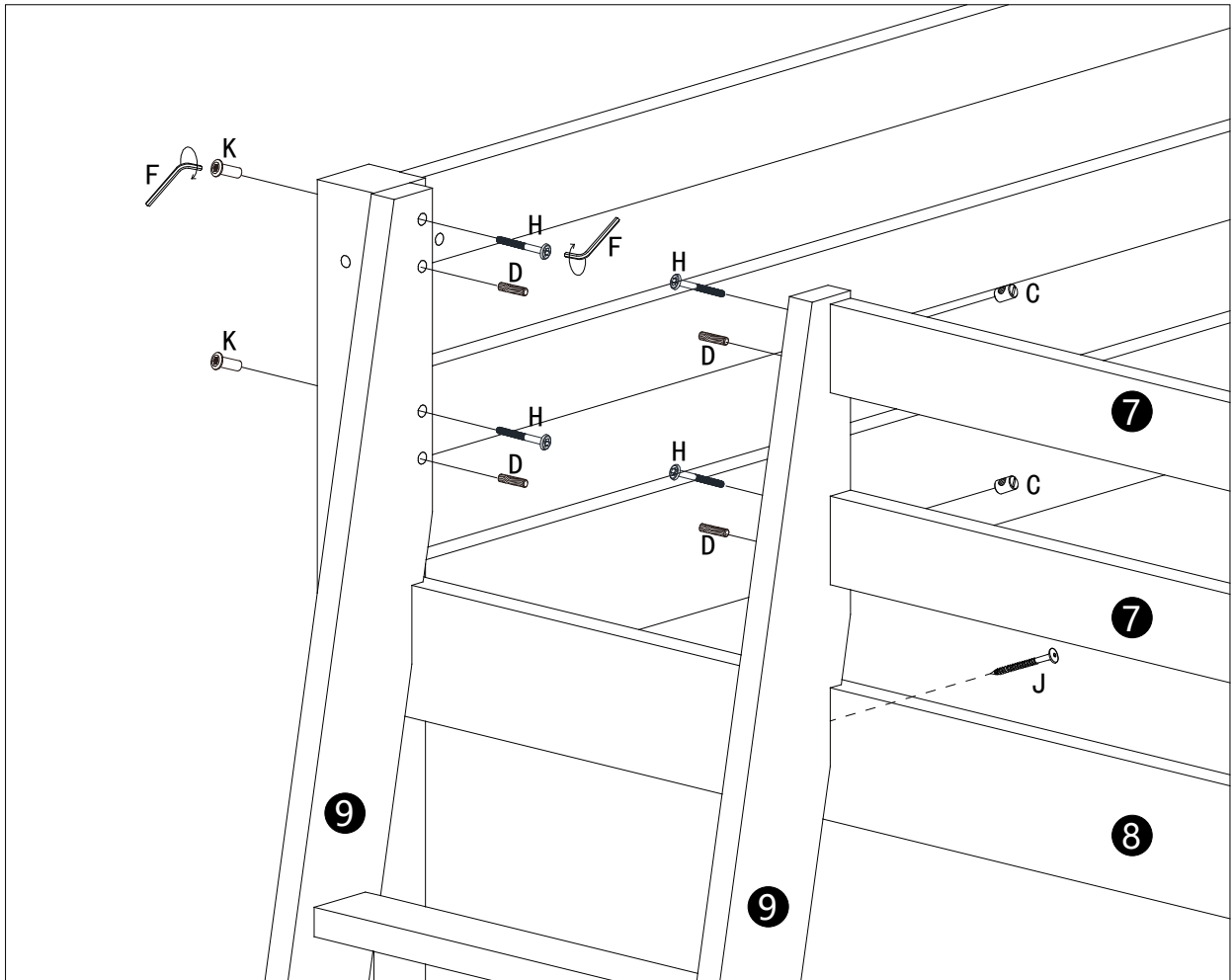

04



B	 Ø7x50mm	12	
F		M4	1



05



C		Ø10x13mm	2
D		Ø8x30mm	4
F		M4	2
H	 15mm	 M6x60mm	4
J	 15mm	 M6x70mm	1
K	 15mm	 M6x20mm	2

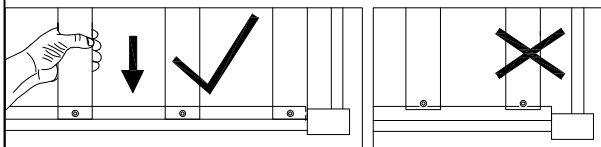
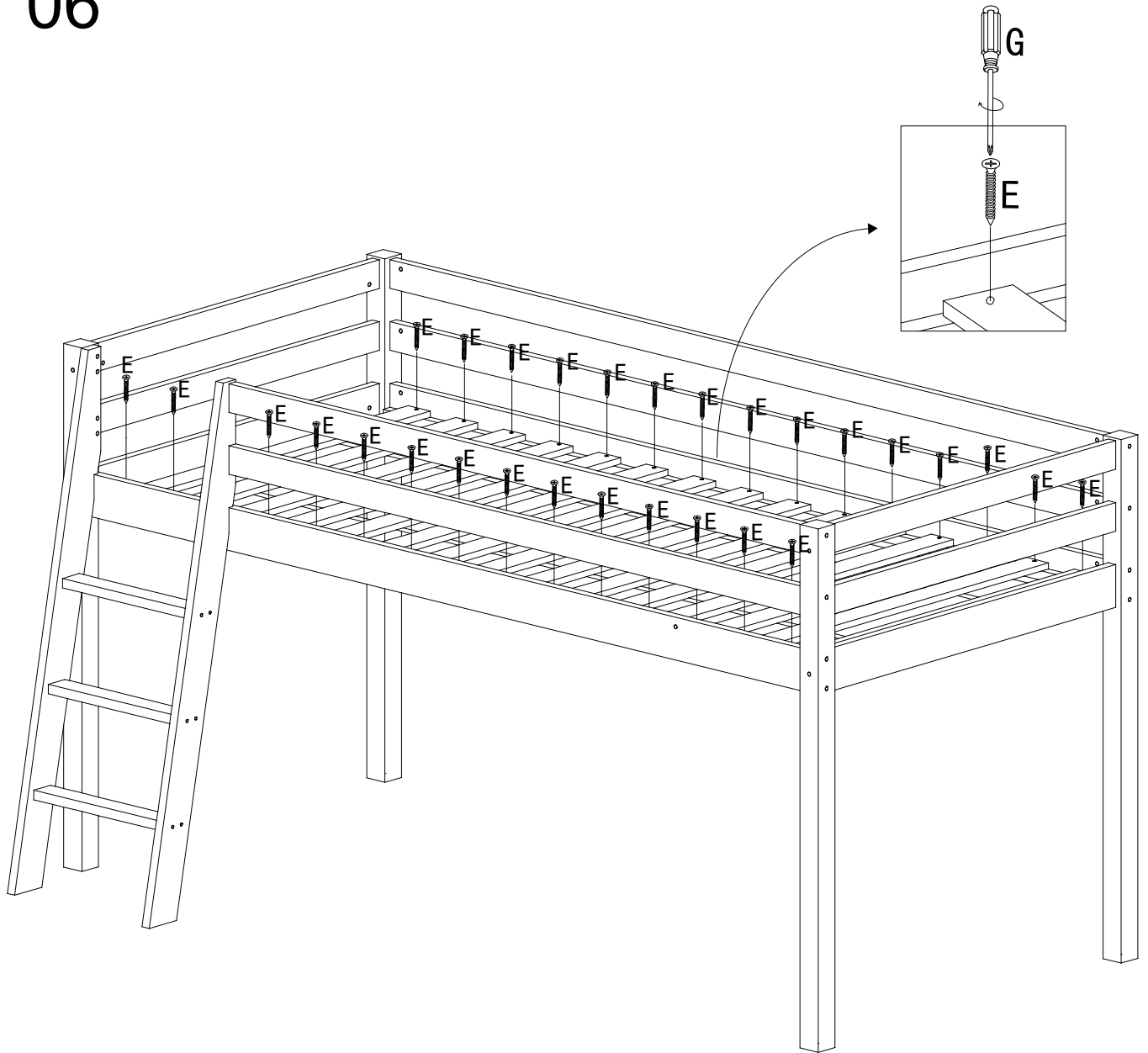

06

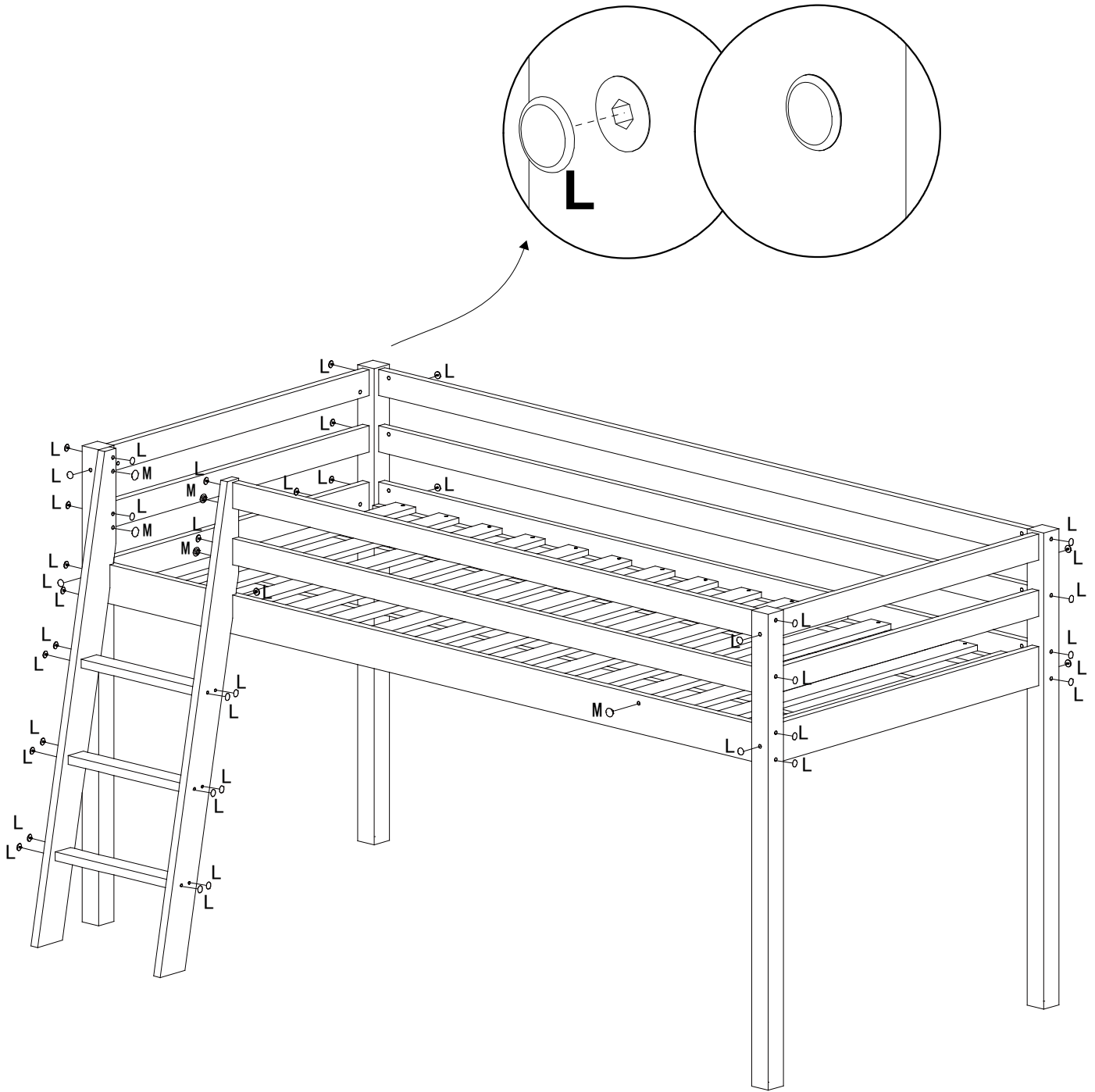

E	 8mm	 Ø4x30mm	30
G			1

07





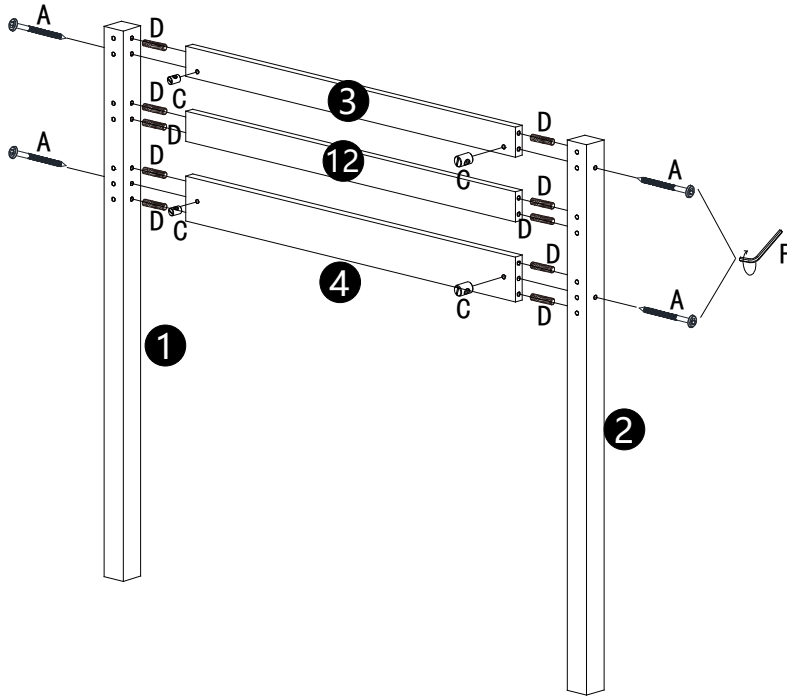

L		41
M		5

01

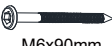



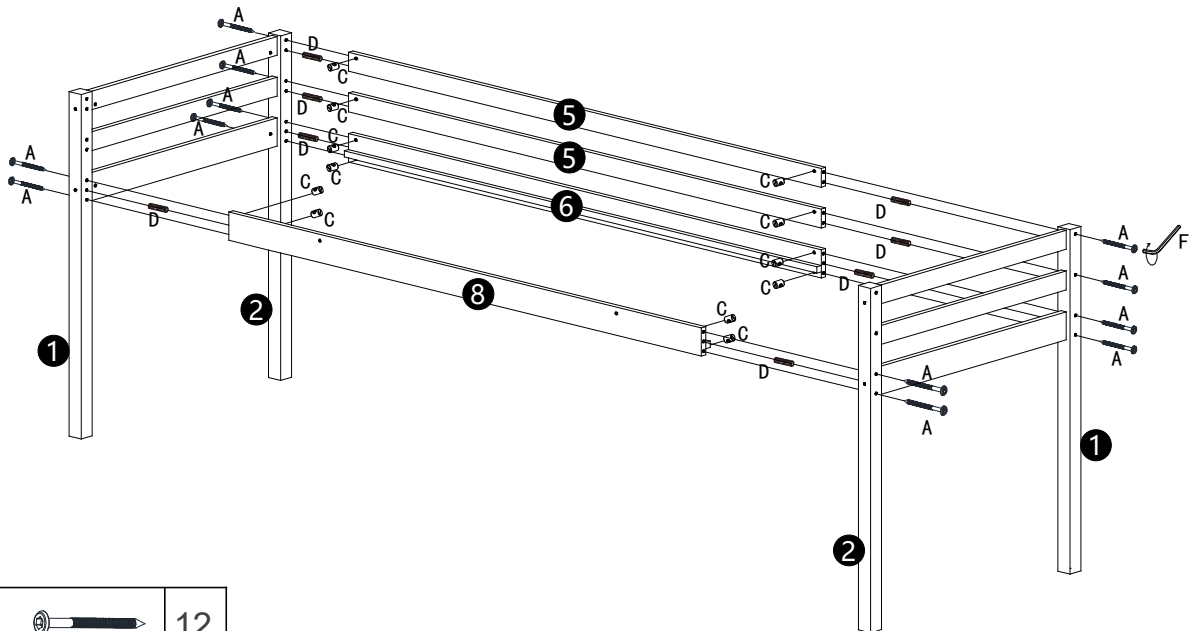

x 2

A	 15mm	 M6x90mm	8
C		$\varnothing 10 \times 13 \text{mm}$	8
D		$\varnothing 8 \times 30 \text{mm}$	20
F		M4	1





02

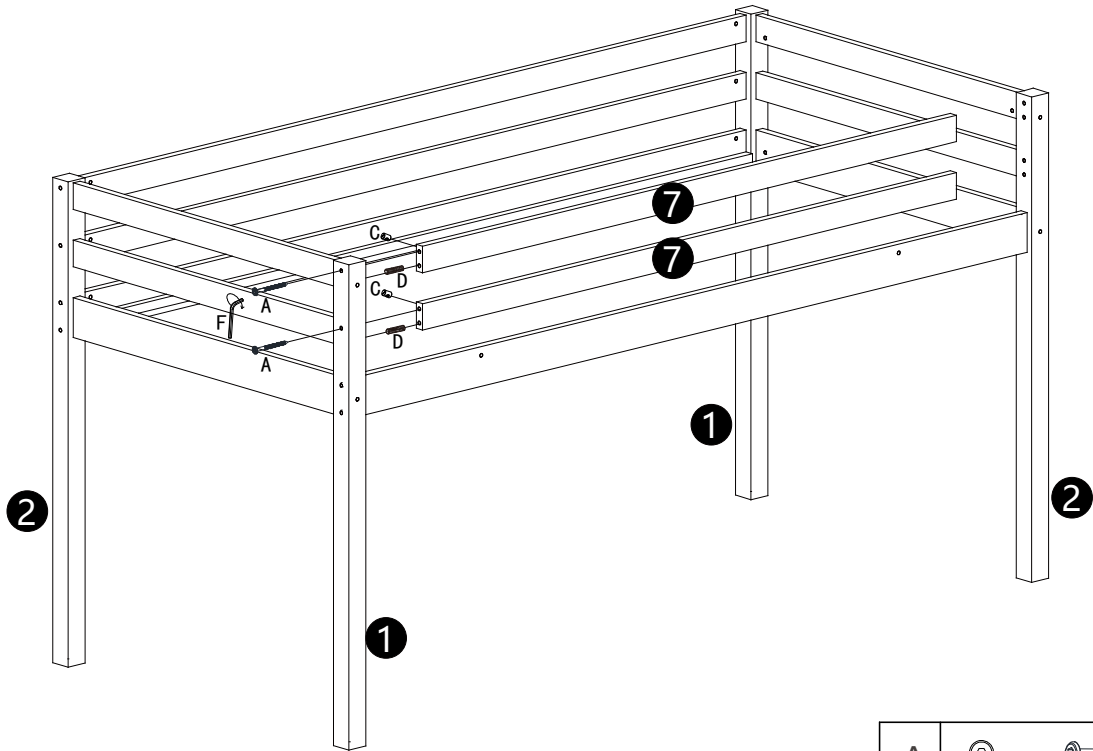

A	 15mm	 M6x90mm	12
C		$\varnothing 10 \times 13 \text{mm}$	12
D		$\varnothing 8 \times 30 \text{mm}$	8
F		M4	1

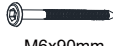

03



A	 15mm	 M6x90mm	2
C		$\varnothing 10 \times 13 \text{mm}$	2
D		$\varnothing 8 \times 30 \text{mm}$	2
F		M4	1

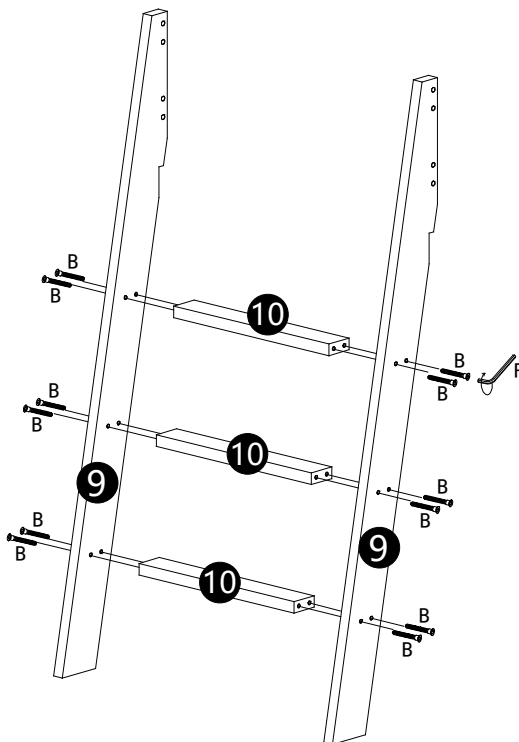





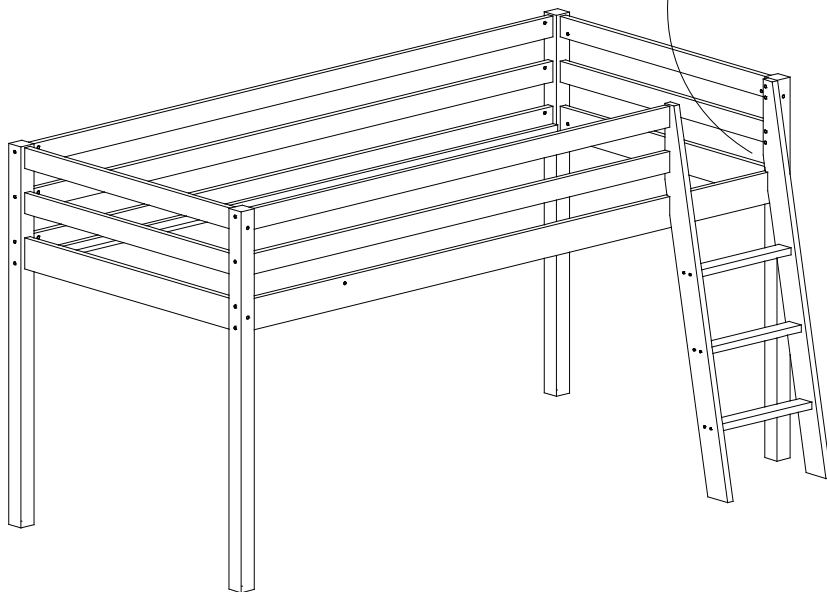
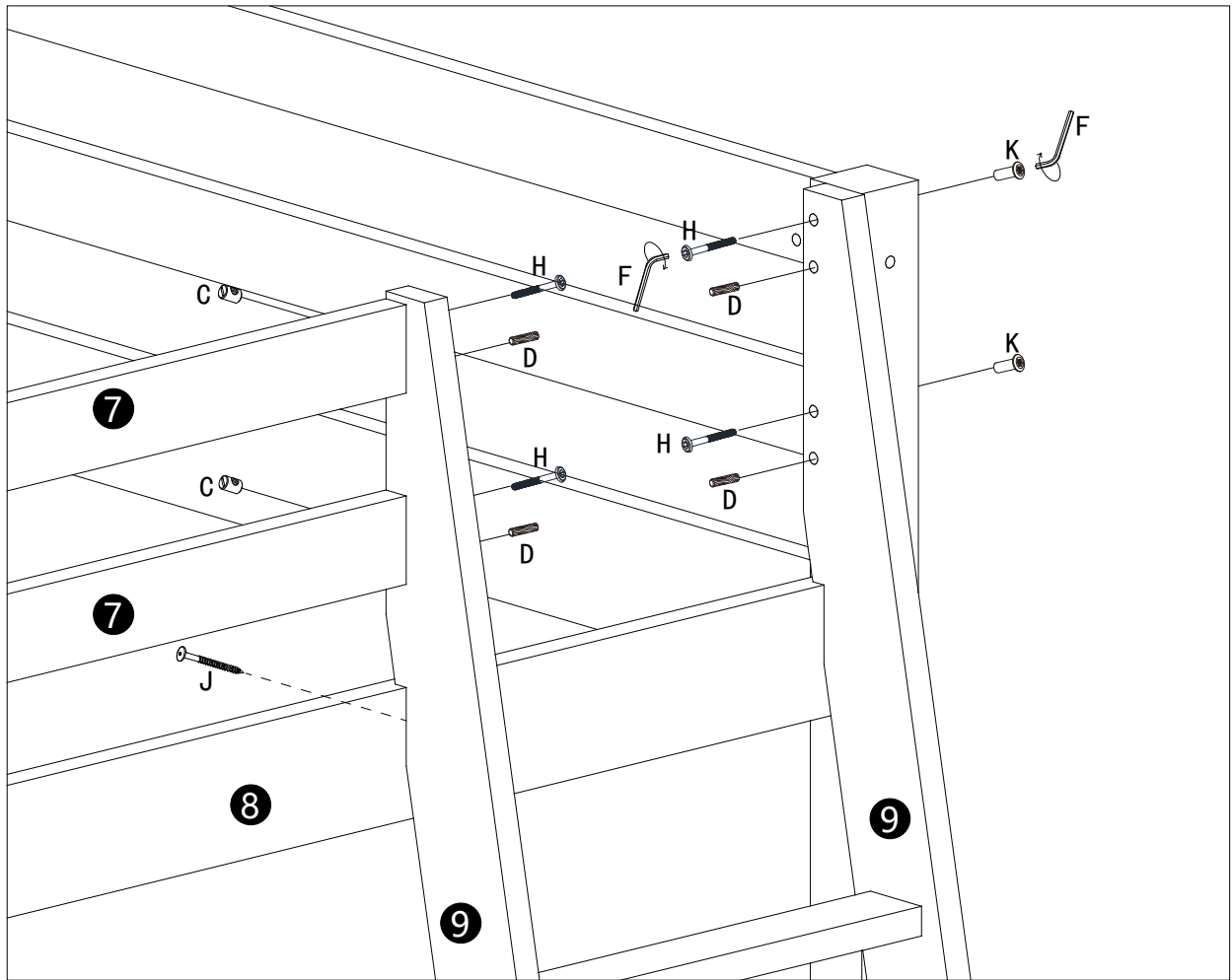

04



B		$\varnothing 7 \times 50 \text{mm}$	12
F		M4	1



05



C		Ø10x13mm	2
D		Ø8x30mm	4
F		M4	2
H	 15mm	 M6x60mm	4
J	 15mm	 M6x70mm	1
K	 15mm	 M6x20mm	2

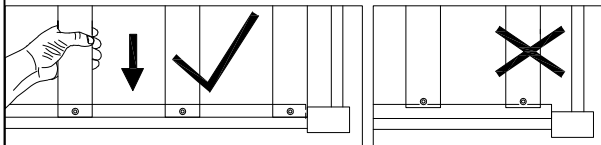
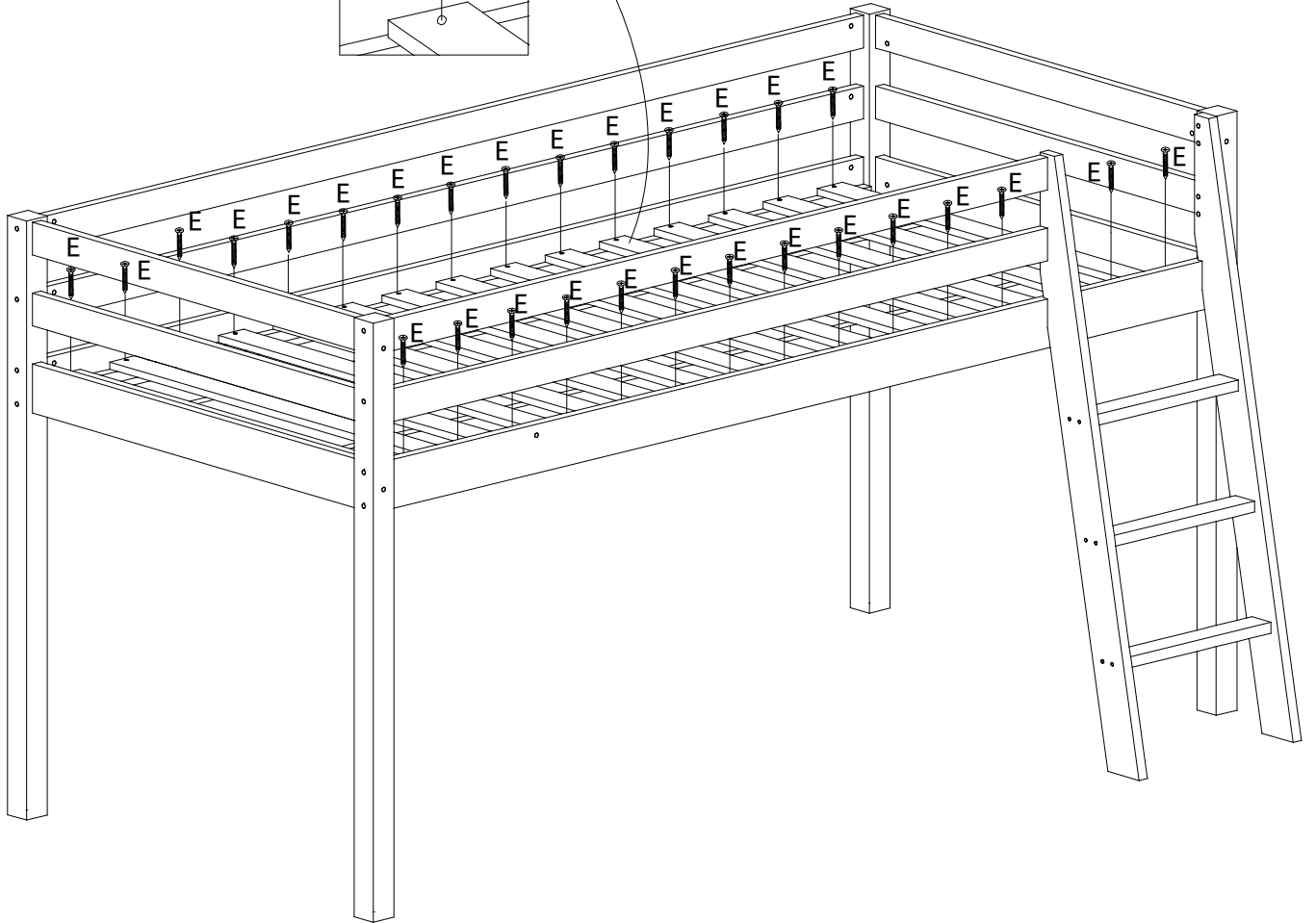
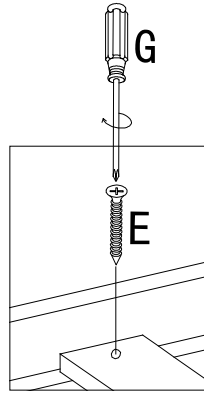

06

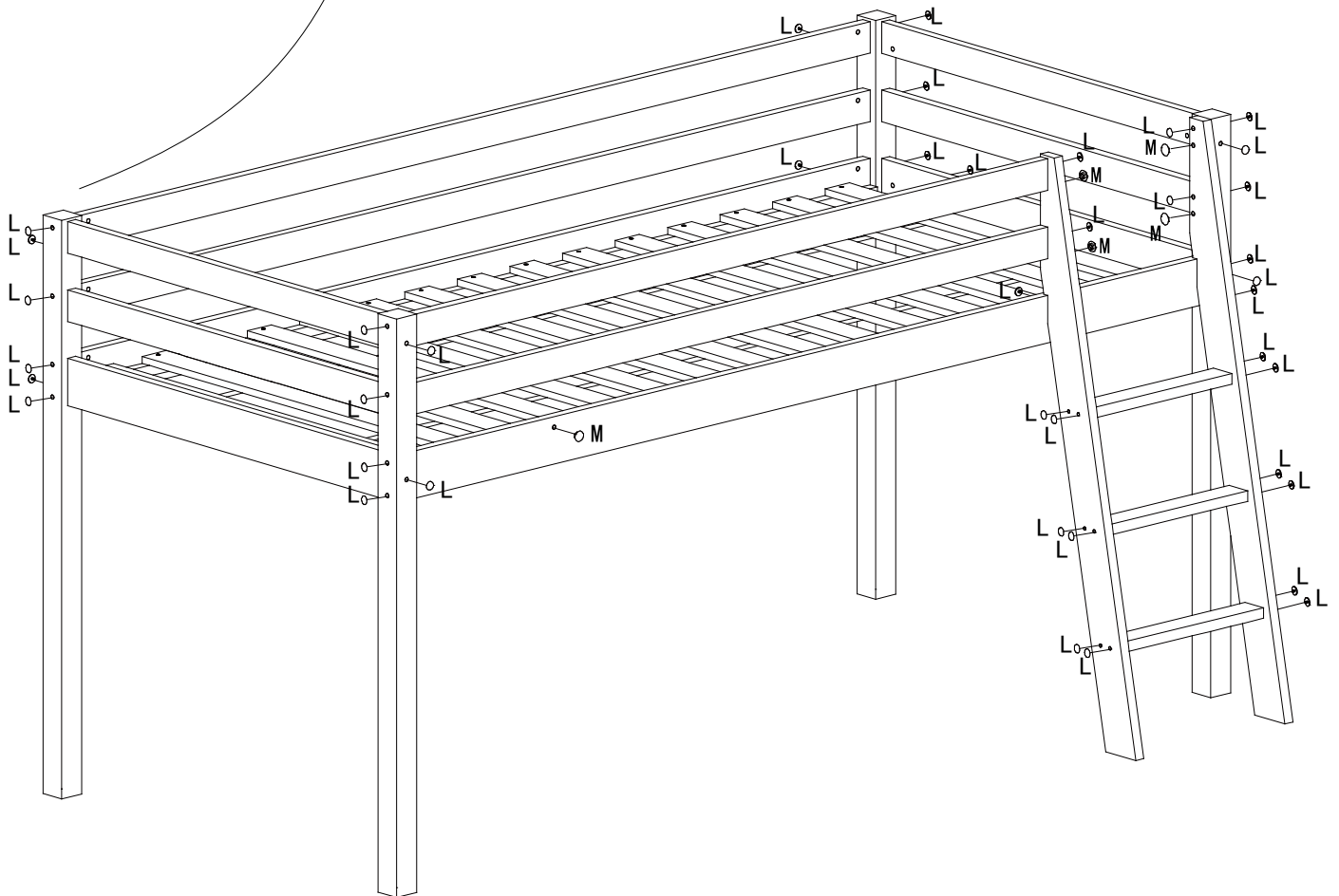
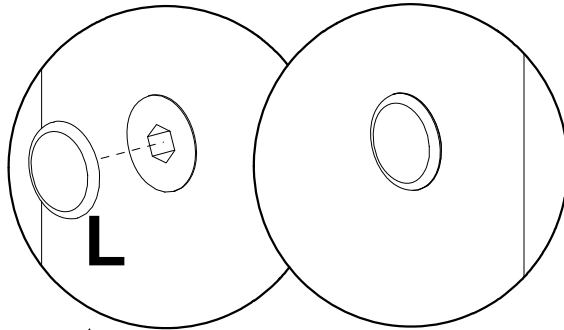

E	 8mm	 Ø4x30mm	30
G			1

07



L		41
M		5

