

# KESTREL 3 SEATER

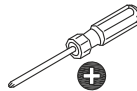

**x1**

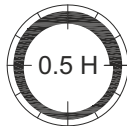
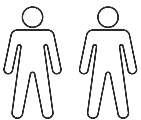
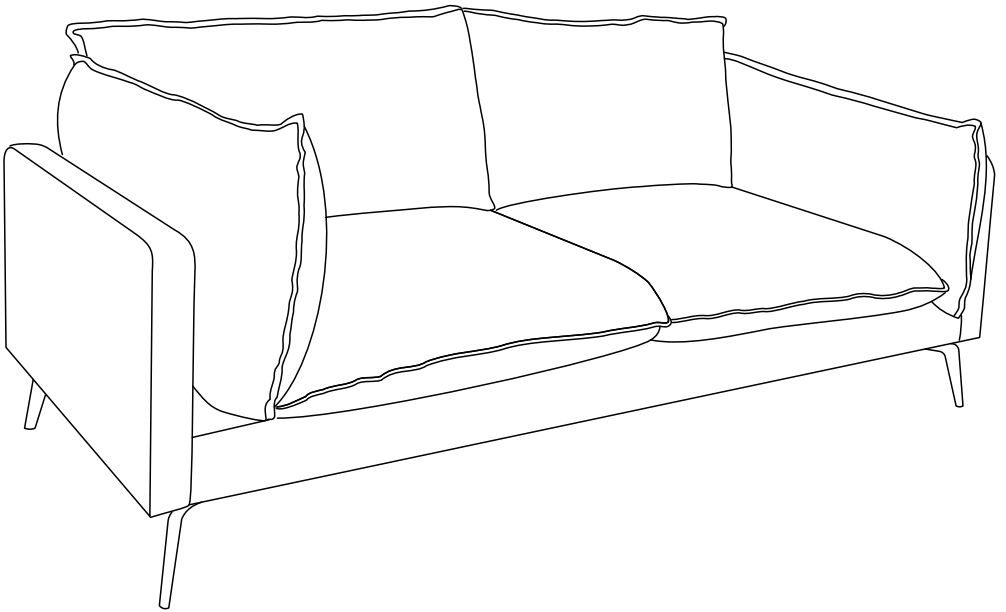
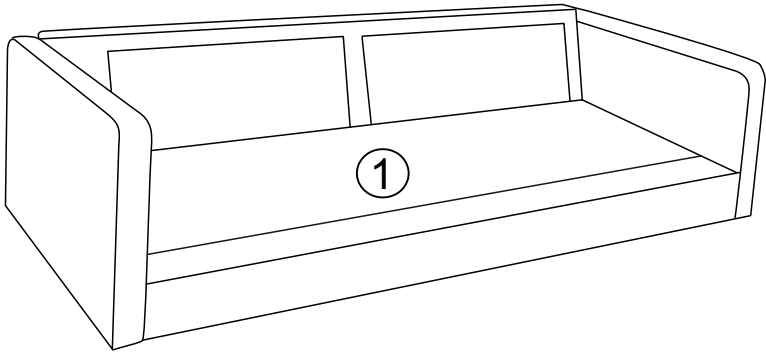

**x2**

**x2**

**x2**

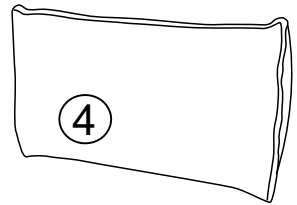
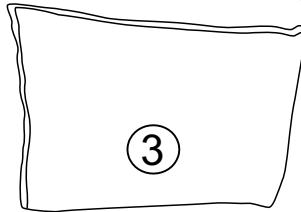
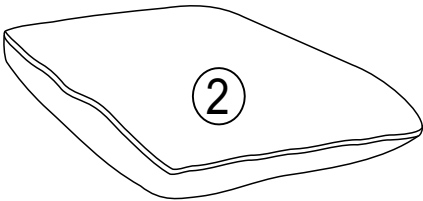

**x4**

**x1**

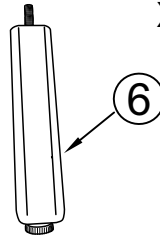
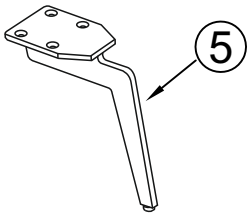

A x 16

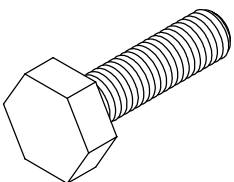

M8 x 25 mm

B x 1

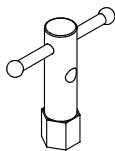

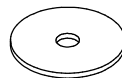

13 mm

C x 1

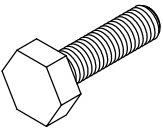
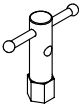

Ø8/Ø50x3 mm

<p>A x 16</p>  <p>M8 x 25 mm</p>	<p>B x 1</p>  <p>13 mm</p>	<p>⑤ x 4</p> 
--	---	--

