





ASSEMBLY INSTRUCTION

STEP 2



STEP 3

HARDWARE LIST

PART	PART#	QTY
 45mm	1	2
 38mm	2	6
	3	8
	4	2
	5	1

STEP 1

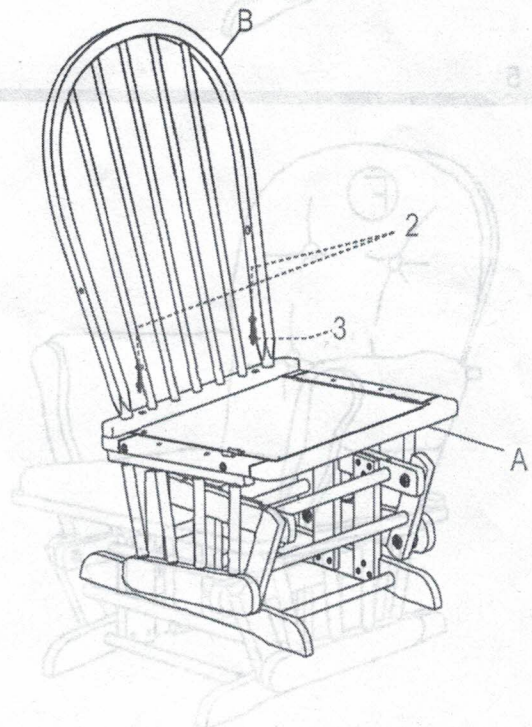

STEP 8

STEP 2

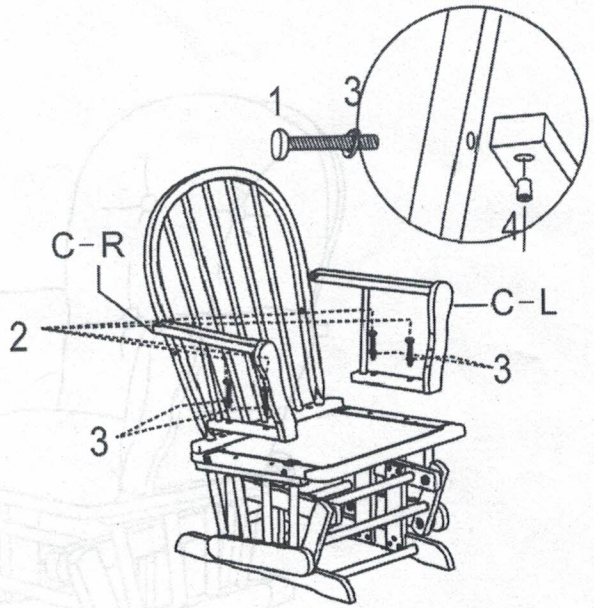

STEP 3

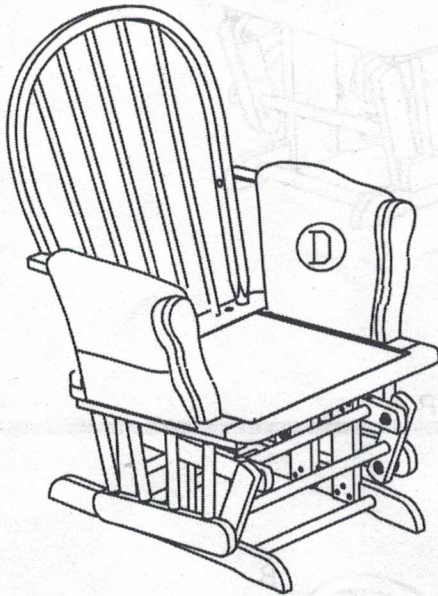

STEP 4

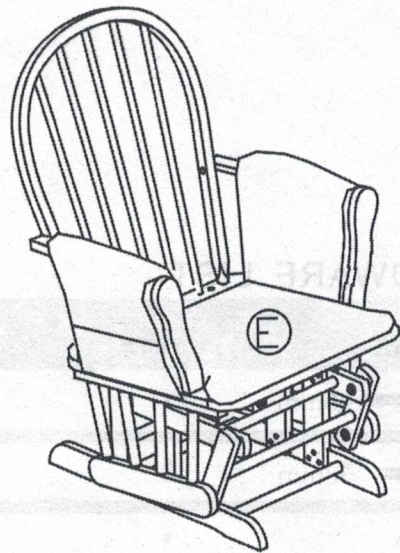

STEP 5

