

Installation sanleitung
Installation Instruction
Instruction d'installation

Artikelnummer/Item Number/Numéro d'article:

N636P443754

N636P443755

DE:Unser Produkt wird Ihnen in 2 Paketen geliefert. Die Lieferzeiten dieser 2 Pakete können abweichen, bitte haben Sie etwas Geduld und vielen Dank für Ihr Verständnis.

UK:Our product will be delivered to you in 2 packages. The delivery times of these 2 packages may differ, please be patient and thank you for your understanding.

FR:Notre produit vous sera livré en 2 colis. Les délais de livraison de ces 2 colis peuvent différer, soyez patient et merci pour votre compréhension.

Hochbett

90X200CM

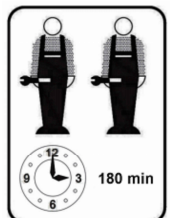
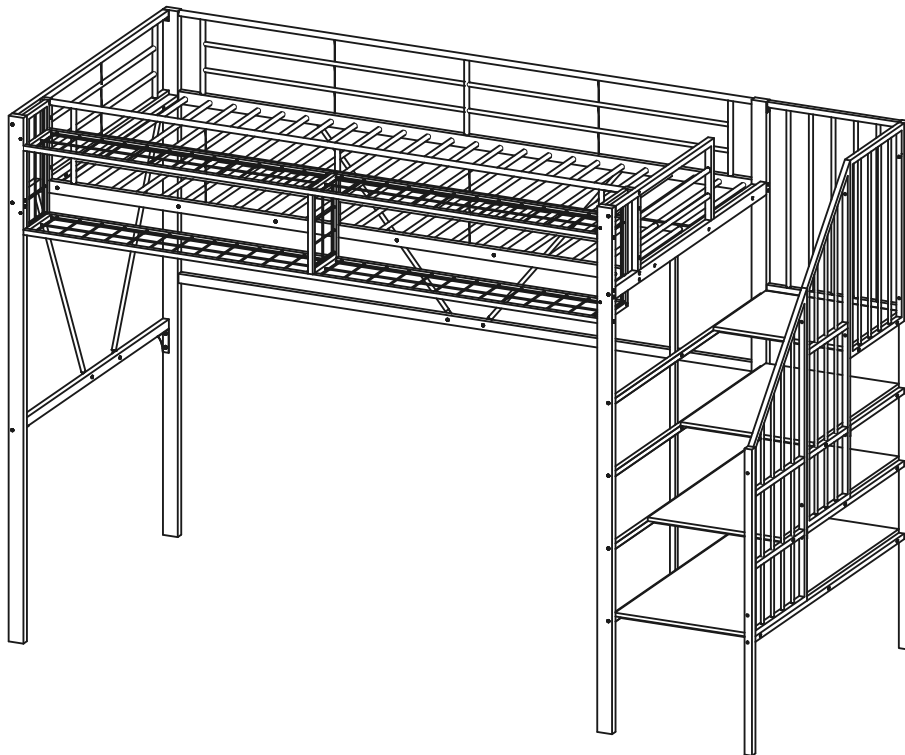

FR

Cet appareil,
ses cordons,
et batterie
se recyclent



ou

Points de collecte sur www.quefairemesdechets.fr
Privilégiez la réparation ou le don de votre appareil !



ANLEITUNG

WICHTIG - SORGFÄLTIG DURCHLESEN – FÜR ZUKÜNFTIGE REFERENZ BEWAHREN

- a) **WARNUNG** - Hochbetten und das Oberbett von Etagenbetten sind wegen der Verletzungsgefahr durch Stürze nicht für Kinder unter sechs Jahren geeignet.
- b) **WARNUNG** - Etagenbetten und Hochbetten können ein ernstes Verletzungsrisiko darstellen, wenn sie nicht ordnungsgemäß verwendet werden. Befestigen oder hängen Sie niemals Gegenstände an einem Teil des Etagenbetts, die nicht für die Verwendung mit dem Bett vorgesehen sind, zum Beispiel Schnüre, Kordeln, Haken, Gurte und Taschen.
- c) **WARNUNG** - Kinder können zwischen Bett und Wand eingeklemmt werden. Um die Gefahr schwerer Verletzungen zu vermeiden, darf der Abstand zwischen der oberen Sicherheitsbarriere und der angrenzenden Konstruktion 75 mm nicht überschreiten oder mehr als 230 mm betragen.
- d) **WARNUNG** - Verwenden Sie das Etagenbett / Hochbett nicht, wenn ein Bauteil beschädigt ist oder fehlt. Ersatzteile werden zwischendurch beim Hersteller oder beim Händler angefordert.
- e) Befolgen Sie unbedingt die Installationsanweisungen und die Gebrauchsanweisung des Herstellers.
- f) Die empfohlene Größe der Matratze für das Bett beträgt 200 cm x 90 cm, maximale Dicke der Matratze: 10 cm.
- g) Es ist notwendig, den Raum zu lüften, um ein niedriges Feuchtigkeitsniveau aufrechtzuerhalten und das Wachstum von Schimmel im Bett und an dessen Peripherie zu verhindern.
- h) Verbindungselemente sollten immer richtig angezogen und regelmäßig überprüft werden. Bei Bedarf festziehen.
- I) **WARNUNG**: sorgt dafür, dass die stufen mit der leiter/treppe dauerhaft mit diesem bereich verbunden sind"Gehen sie schlafen, bevor sie benutzen."
- J) **WARNUNG**: das produkt muss an eine wand Oder eine architektonische struktur angeschlossen sein.
- K) Erfüllt die Anforderungen der europäischen Norm NC-Sicherheit **EN 747-1: 2024**

INSTRUCTIONS

IMPORTANT - READ CAREFULLY - RETAIN FOR FUTURE REFERENCE

- a) **WARNING** - High beds and the upper bed of bunk beds are not suitable for children under six years due to the risk of injury from falls;
- b) **WARNING** - Bunk beds and high beds can present a serious risk of injury from strangulation if not used correctly. Never attach or hang items to any part of the bunk bed that are not designed to be used with the bed, for example, but not limited to ropes, strings, cords, hooks, belts and bags.
- c) **WARNING** - Children can become trapped between the bed and the wall, a roof pitch, the ceiling adjoining pieces of furniture (e.g. cupboards) and the like. To avoid risk of serious injury the distance between the top safety barrier and the adjoining structure shall not exceed 75 mm or shall be more than 230 mm.
- d) **WARNING** - Do not use the bunk bed/high bed if any structural part is broken or missing; Replacement parts are between requested from the manufacturer or the store.
- e) it is imperative to always follow the installation instructions and manufacturer's use.
- f) The recommended size of the mattress to be used with the bed is 200cm x90cm, maximum thickness mattress:10cm.
- g) It is necessary to ventilate the room in order to maintain a low level moisture and prevent mold growth in the bed and its periphery.
- h) Joining devices should always be tightened properly and regularly verified. Tighten if necessary.
- i) **WARNING** - "Always ensure the platform and the ladder / stairs are permanently attached to this bunkbed before use"
- j) **WARNING** - "This product must be attached to a wall or building structure"
- k) Meets European standard requirements NC safety **EN 747-1: 2024** .

INSTRUCTIONS

IMPORTANT - À LIRE ATTENTIVEMENT - CONSERVER POUR RÉFÉRENCE ULTÉRIEURE

- a) **AVERTISSEMENT** - Les lits surélevés et le lit supérieur des lits superposés ne conviennent pas aux enfants de moins de six ans en raison du risque de blessure dû à une chute;
- b) **AVERTISSEMENT** - Les lits superposés et les lits surélevés peuvent présenter un risque sérieux de blessure par strangulation s'ils ne sont pas utilisés correctement. Ne jamais attacher ou suspendre à des parties du lit superposé des objets qui ne sont pas conçus pour être utilisés avec le lit, par exemple, mais ne se limitant pas à des cordes, des ficelles, des cordes, des crochets, des ceintures et des sacs.
- c) **AVERTISSEMENT** - Les enfants peuvent rester coincés entre le lit et le mur, un toit incline les meubles adjacents au plafond (par exemple, des armoires), etc. Pour éviter tout risque de blessure grave, la distance entre la barrière de sécurité supérieure et la structure adjacente ne doit pas dépasser 75 mm ou doit être supérieure à 230 mm.
- d) **AVERTISSEMENT** - N'utilisez pas le lit superposé / le lit surélevé si une partie de la structure est cassée ou manquante. Les pièces de rechange sont demandées au fabricant ou au magasin.
- e) il est impératif de toujours suivre les instructions d'installation et l'utilisation du fabricant.
- f) La taille recommandée du matelas à utiliser avec le lit est 200 cm x 90 cm, épaisseur maximale du matelas: 10 cm.
- g) Il est nécessaire de ventiler la pièce afin de maintenir un faible niveau d'humidité et d'empêcher la formation de moisissure dans le lit et à sa périphérie.
- h) Les dispositifs de jonction doivent toujours être correctement serrés et vérifiés régulièrement. Serrer si nécessaire.
- I) **AVERTISSEMENT** - assurez-vous toujours que la plate-forme et l'échelle/escalier sont fixés en permanence à cette couchette Lit avant utilisation"
- J) **AVERTISSEMENT** - "ce produit doit être fixé à un mur ou à une structure de bâtiment"
- K) Conforme aux exigences de la norme européenne en matière de sécurité NC **EN 747-1: 2024** .

ISTRUZIONI

IMPORTANTE - LEGGERE ATTENTAMENTE - CONSERVARE IL FUTURO RIFERIMENTO

- a) **ATTENZIONE** - I letti alti e il letto superiore a castello non sono adatti a bambini di età inferiore ai sei anni a causa del rischio di lesioni da cadute;
- b) **AVVERTENZA** - I letti a castello e i letti alti possono presentare un serio rischio di lesioni a causa di strangolamento se non utilizzati correttamente. Non attaccare o appendere mai oggetti a qualsiasi parte del letto a castello che non sono progettati per essere utilizzati con il letto, ad esempio, ma non limitato a corde, corde, corde, ganci, cinture e borse.
- c) **AVVERTENZA** - I bambini possono rimanere intrappolati tra il letto e la parete, un tetto inclinato il mobile adiacente al soffitto (ad es. armadi) e simili. Per evitare il rischio di gravi lesioni, la distanza tra la barriera di sicurezza superiore e a struttura adiacente non deve superare 75 mm o deve essere superiore a 230 mm.
- d) **ATTENZIONE** - Non utilizzare il letto a castello / letto alto se qualche parte strutturale è rotta o mancante; Le parti di ricambio sono tra quelle richieste al produttore o al negozio.
- e) è indispensabile seguire sempre le istruzioni di installazione e l'uso del produttore.
- f) Le dimensioni consigliate del materasso da utilizzare con il letto sono 200 cm x 90 cm, materasso di massimo spessore: 10 cm.
- g) È necessario ventilare l'ambiente per mantenere un'umidità bassa e prevenire la formazione di muffe nel letto e nella sua periferia.
- h) I dispositivi di giunzione devono essere sempre serrati correttamente e regolarmente verificati. Stringere se necessario.
- I) **ATTENZIONE** - "assicurarsi sempre che il marciapiede e la scala/scale siano fissati in modo permanente a questa cuccetta Letto prima dell' uso"
- J) **ATTENZIONE** - "questo prodotto deve essere fissato a una parete o a una struttura di costruzione"
- K) Soddisfa i requisiti della norma europea Sicurezza NC **EN 747-1: 2024** .

INSTRUCTIES

BELANGRIJK - LEES AANDACHTIG - BEWAAR VOOR

TOEKOMSTIGE REFERENTIE

- a) **WAARSCHUWING** - Hoge bedden en het bovenste bed van stapelbedden zijn niet geschikt voor kinderen jonger dan zes jaar vanwege het risico op letsel door vallen;
- b) **WAARSCHUWING** - Stapelbedden en hoge bedden kunnen een ernstig risico op verwonding vormen als ze niet correct worden gebruikt. Bevestig of hang nooit items aan een deel van het stapelbed die niet zijn ontworpen voor gebruik met het bed, bijvoorbeeld, maar niet beperkt tot touwen, koorden, koorden, haken, riemen en tassen.
- c) **WAARSCHUWING** - Kinderen kunnen vast komen te zitten tussen het bed en de muur, een dakhelling het plafond aangrenzende meubels (bijv. kasten) en dergelijke. Om het risico van ernstig letsel te voorkomen, mag de afstand tussen de bovenste veiligheidsbarrière en de aangrenzende structuur niet groter zijn dan 75 mm of meer dan 230 mm.
- d) **WAARSCHUWING** - Gebruik het stapelbed / hoogbed niet als een structureel onderdeel kapot is of ontbreekt; Vervangende onderdelen worden tussen gevraagd door de fabrikant of de winkel.
- e) het is noodzakelijk om altijd de installatie-instructies en het gebruik van de fabrikant te volgen.
- f) De aanbevolen maat van de matras die met het bed wordt gebruikt, is 200 cm x 90 cm, maximale dikte matras: **10** cm.
- g) Het is noodzakelijk om de kamer te ventileren om een laag vochtgehalte te handhaven en schimmelgroei in het bed en de periferie ervan te voorkomen.
- h) Verbindingsinrichtingen moeten altijd goed worden vastgedraaid en regelmatig worden gecontroleerd. Draai indien nodig vast.
- i) **WAARSCHUWING** - zorg ervoor dat het platform en de ladder/trap permanent verbonden zijn met deze kooi
Slapen voor gebruik"
- j) **WAARSCHUWING** - dit product moet worden bevestigd aan muren of gebouwen.
- k) Voldoet aan Europese standaardvereisten NC-veiligheid **EN 747-1: 2024** .

INSTRUKCE

DŮLEŽITÉ - PŘEČTĚTE SI POZORNĚ - UCHOVÁVAJTE

PRO BUDOUCÍ REFERENCE

- a) **VAROVÁNÍ** - vysoké postele a horní lůžka palandy nejsou vhodné pro děti do šesti let z důvodu rizika zranění pádem;
- b) **VAROVÁNÍ** - Patrové postele a vysoké postele mohou představovat vážné riziko zranění při uškrcení, pokud nebudou správně použity. Nikdy nepřipevňujte ani nezavěšujte předměty na žádnou část palandy, které nejsou navrženy pro použití s postelí, ale neomezuje se pouze na lana, provázky, šňůry, háčky, pásy a tašky.
- c) **VÝSTRAHA** - Děti se mohou zachytit mezi postel a zeď, sklonit střechu stropy přilehlé kusy nábytku (např. skříňě) a podobně. Aby se zabránilo riziku vážného zranění, nesmí vzdálenost mezi horní bezpečnostní bariérou a sousední konstrukcí překročit 75 mm nebo být větší než 230 mm.
- d) **VÝSTRAHA** - Nepoužívejte patrové lůžko / vysoké lůžko, pokud je některá konstrukční část zlomená nebo chybí; Náhradní díly jsou mezi na vyžádání od výrobce nebo obchodu.
- e) je bezpodmínečně nutné dodržovat instalační pokyny a použití výrobcem.
- f) Doporučená velikost matrace pro použití s postelí je 200 cm x 90 cm, maximální tloušťka matrace: **10** cm.
- g) Místnost je nutné ventilovat, aby se udržela nízká hladina vlhkosti a zabránilo se růstu plísní v loži a jeho obvodu.
- h) Spojovací zařízení by měla být vždy pevně dotažena a pravidelně ověřována. V případě potřeby dotáhněte.
- i) **VAROVÁNÍ** - "Vidy se ujistěte, že plosina a Zebiiik / schody jsou trvale připevněny k této palandě před použitím uložte"
- j) **VAROVÁNÍ** - "Tento výrobek musí být připevněn ke zdi nebo stavební konstrukci"
- k) Splňuje požadavky evropské normy NC bezpečnost **EN 747-1: 2024** .

IINSTRUKCJE

WAŽNE - PRZECZYTAJ UWAZNIE - ZACHOWAJ NA

PRZYSZŁOŚĆ

- a) **OSTRZEŻENIE** - Wysokie łózka i górne łózko łózek piętrowych nie są odpowiednie dla dzieci poniżej sześciu lat ze względu na ryzyko obrażeń w wyniku upadku;
- b) **OSTRZEŻENIE** - Łózka piętrowe i wysokie łózka mogą stwarzać poważne ryzyko obrażeń na skutek uduszenia, jeśli nie zostaną właściwie użyte. Nigdy nie mocuj ani nie wieszaj przedmiotów na żadnej części łózka piętrowego, które nie są przeznaczone do użytku z łóżkiem, na przykład, ale nie ograniczając się do lin, sznurków, sznurków, haczyków, pasów i toreb.
- c) **OSTRZEŻENIE** - Dzieci mogą zostać uwięzione między łóżkiem a ścianą, nachyleniem dachu pod sufitem przylegającymi meblami (np. szafkami) i tym podobne. Aby uniknąć ryzyka poważnych obrażeń, odległość między górną barierą bezpieczeństwa a przylegającą konstrukcją nie może przekraczać 75 mm lub być większa niż 230 mm.
- d) **OSTRZEŻENIE** - Nie używaj łózka piętrowego / wysokiego łózka, jeśli jakkolwiek część konstrukcyjna jest zepsuta lub brakuje jej; Części zamienne są wymagane od producenta lub sklepu.
- e) bezwzględnie należy przestrzegać instrukcji instalacji i użytkowania producenta.
- f) Zalecany rozmiar materaca do zastosowania z łóżkiem to 200 cm x 90 cm, maksymalna grubość materaca: **10** cm.
- g) Konieczna jest wentylacja pomieszczenia w celu utrzymania niskiego poziomu wilgoci i zapobiegania rozwojowi pleśni w łózku i jego obrzeżach.
- h) Urządzenia łączące powinny być zawsze odpowiednio dokręcone i regularnie sprawdzane. Dokręcić w razie potrzeby.
- i) **OSTRZEŻENIE** "Zawsze upewnij się, że platforma i drabina / schody są na stałe przymocowane do tego leżanki łózko przed użyciem"
- j) **OSTRZEŻENIE** "Ten produkt musi być przymocowany do ściany lub konstrukcji budynku"
- k) Spełnia wymagania norm europejskich Bezpieczeństwo NC **EN 747-1: 2024** .

INŠTRUKCIE

DÔLEŽITÉ - POZORNE SI PREČÍTAJTE -

UCHOVÁVAJTE PRE BUDÚCE REFERENCIE

- a) **VÝSTRAHA** - Vysoké postele a horné postele poschodových postelí nie sú vhodné pre deti do šiestich rokov kvôli riziku zranenia pádom;
- b) **VÝSTRAHA** - poschodové postele a vysoké postele môžu predstavovať vážne riziko zranenia priškrtením, ak sa nebudú správne používať. Nikdy nepripevňujte ani nevešajte predmety k žiadnej časti poschodovej postele, ktorá nie je určená na použitie s postelou, napríklad, ale nielen, laná, šnúry, šnúry, háčiky, pásy a tašky.
- c) **VÝSTRAHA** - Deti sa môžu zachytiť medzi postelou a stenou, sklonom strechy, stropom priliehajúcim kusy nábytku (napr. skrinky) a podobne. Aby sa predišlo riziku vážneho zranenia, vzdialenosť medzi hornou bezpečnostnou bariérou a príľahlou konštrukciou nesmie prekročiť 75 mm alebo byť viac ako 230 mm.
- d) **VÝSTRAHA** - Nepoužívajte poschodovú posteľ / vysoké lóžko, ak je akákoľvek konštrukčná časť poškodená alebo chýba; Náhradné diely sú potrebné na vyžiadanie od výrobcu alebo skladu.
- e) je bezpodmienečne nutné postupovať podľa pokynov na inštaláciu a podľa pokynov výrobcu.
- f) Odporúčaná veľkosť matrace použitého na lóžko je 200 cm x 90 cm, maximálna hrúbka matrace: **10** cm.
- g) Miestnosť je potrebné vetrať, aby sa udržala nízka úroveň vlhkosti a zabránilo sa rastu plesní v lóžku a jeho obvode.
- h) Spojovacie zariadenia by sa mali vždy pevne dotiahnuť a pravidelne preverovať. V prípade potreby dotiahnite.
- i) **VÝSTRAHA** - "Vždy sa uistite, že plosina a rebrík/schody sÁ trvalo pripevnené k tomuto lóžku
lÁžko pred použitím"
- j) **VÝSTRAHA** - "Tento výrobok musí byť pripevnený k stene alebo stavebnej konštrukcii"
- k) Splňa požiadavky európskych noriem NC bezpečnosť **EN 747-1: 2024** .

UTASÍTÁS

FONTOS - OLVASSA EL FIGYELMESEN - VÁRJON A JÖVŐBEN

- a) **VIGYÁZAT** - A magas ágyak és az emeletes ágyak felső ágya nem alkalmas hat év alatti gyermekek számára az esések sérülésének veszélye miatt;
- b) **FIGYELMEZTETÉS** - Az emeletes ágyak és a magas ágyak súlyos sérülést okozhatnak a fojtogatás következtében, ha nem használják helyesen. Soha ne csatlakoztasson és ne lógjon az emeletes ágy olyan részeire, amelyeket például nem az ágyhoz való felhasználásra terveztek, de ezekre nem korlátozódnak: kötelek, húrok, zsinórok, horgok, övek és táskák.
- c) **FIGYELMEZTETÉS** - A gyermekek becsapódhatnak az ágy és a fal közé, tetőtéri a mennyezetet a szomszédos bútorokhoz (például szekrényekhez) és hasonlókat. A súlyos sérülés kockázatának elkerülése érdekében a felső biztonsági akadály és a szomszédos szerkezet közötti távolság nem haladhatja meg a 75 mm-t vagy több, mint 230 mm.
- d) **FIGYELMEZTETÉS** - Ne használja az emeletes ágyat / magas ágyat, ha valamelyik szerkezeti elem törött vagy hiányzik; A cserealkatrészeket a gyártótól vagy a bolttól kérheti.
- e) feltétlenül kövesse a telepítési utasításokat és a gyártó általi felhasználást.
- f) Az ágyhoz használni kívánt matrac ajánlott mérete 200 cm x 90 cm, a matrac maximális vastagsága: **10 cm**.
- g) Szellőztetni kell a helyiséget, hogy fennmaradjon az alacsony nedvességtartalom, és megakadályozzák a penész növekedését az ágyban és annak peremén.
- h) A csatlakozóberendezéseket mindig megfelelően meg kell húzni és rendszeresen ellenőrizni kell. Szükség esetén húzza meg.
- i) **FIGYELMEZTETÉS** - "Mindig győződjön meg arról, hogy a platform és a létra / lépcső Állandóan ehhez az Ágyhoz van rögzítve Ágy használat előtt"
- j) "Ezt a terméket falhoz vagy épületszerkezethez kell rögzíteni"
- k) Megfelel az európai szabvány követelményeinek NC biztonsági **EN 747-1: 2024**

INSTRUCȚIUNI

IMPORTANT - CITIȚI CU ATENȚIE - PĂȚIȚI PENTRU REFERINȚĂ VIITORĂ

- a) **AVERTIZARE** - Paturile înalte și patul superior al paturilor nu sunt potrivite pentru copiii sub șase ani din cauza riscului de rănire din cauza căderilor;
- b) **AVERTIZARE** - Paturile suprapuse și paturile înalte pot prezenta un risc grav de rănire din cauza strangulării dacă nu sunt utilizate corect. Nu atașați și nu agățați niciodată articole pe nicio parte a patului care nu sunt concepute pentru a fi utilizate cu patul, de exemplu, dar fără a se limita la frânghii, corzi, șnururi, cârlige, curele și saci.
- c) **AVERTIZARE** - Copiii pot deveni prinși între pat și perete, pot acoperi acoperișul pe piesele de mobilier alăturate (de ex. dulapuri) și altele asemenea. Pentru a evita riscul de rănire gravă, distanța dintre bariera de siguranță superioară și structura alăturată nu trebuie să depășească 75 mm sau să fie mai mare de 230 mm.
- d) **AVERTIZARE** - Nu folosiți patul supraetajat / patul înalt dacă o parte structurală este ruptă sau lipsește; Piesele de schimb se fac între solicitarea producătorului sau a magazinului.
- e) este obligatoriu să respectați întotdeauna instrucțiunile de instalare și utilizarea producătorului.
- f) Dimensiunea recomandată a saltelei care va fi folosită cu patul este de 200cm x90cm, grosimea maximă a saltelei: **10 cm**.
- g) Este necesară ventilarea camerei pentru a menține o umiditate la nivel scăzut și a preveni creșterea mușcăiului în pat și la periferia acesteia.
- h) Dispozitivele de îmbinare trebuie întinse întotdeauna corect și verificate regulat. Strângeți dacă este necesar.
- i) **AVERTIZARE** - "Asigurați-vă întotdeauna că platforma și scara / scările sunt atașate permanent la acest pat înainte de utilizare"
- j) **AVERTIZARE** - "Acest produs trebuie atașat la un perete sau la o structură a clădirii"
- k) Îndeplinește cerințele standardelor europene privind siguranța NC **EN 747 -1: 2024**.

TALÍMATLAR

ÖNEMLİ - DİKKATLE OKUYUN - GELECEK REFERANS

İÇİN TUTUN

- a) **UYARI** - Yüksek yataklar ve ranzaların üst yatağı, düşme nedeniyle yaralanma tehlikesi nedeniyle altı yaşın altındaki çocuklar için uygun değildir;
- b) **UYARI** - Ranzalar ve yüksek yataklar, doğru kullanılmadığı takdirde boğulma nedeniyle ciddi yaralanma riski oluşturabilir. Hiçbir zaman ranza yatağının, yatakla birlikte kullanılmak üzere tasarlanmamış, ancak ipler, ipler, kordonlar, kancalar, kayışlar ve çantalar ile sınırlı olmamak üzere herhangi bir parçasına takmayın veya asılmayın.
- c) **UYARI** - Çocuklar yatakla duvar arasında sıkışıp kalabilir, tavana bitişik mobilya parçaları (örneğin dolaplar) ve benzeri bir tavan döşenir. Ciddi yaralanma riskini önlemek için üst güvenlik bariyeri ve bitişik yapı arasındaki mesafe 75 mm'yi geçmemelidir veya 230 mm'den fazla olmalıdır.
- d) **UYARI** - Herhangi bir yapısal parça kırılmış veya eksikse ranza / yüksek yatak kullanmayın; Yedek parçalar üretici veya mağazadan talep arasındadır.
- e) her zaman kurulum talimatlarını ve üreticinin kullanımını takip etmek zorunludur.
- f) Yatak ile birlikte kullanılması tavsiye edilen yatak boyutu 200 cm x 90 cm, maksimum kalınlık yatağı: **10 cm**'dir.
- g) Düşük seviyede nem sağlamak ve yatak ve çevresinde küf oluşumunu önlemek için odanın havalandırılması gerekir.
- h) Birleştirme cihazları her zaman uygun şekilde sıkılmalı ve düzenli olarak kontrol edilmelidir. Gerekirse sıkın.
- i) **UYARI** - "Her zaman platformun ve merdivenin / merdivenlerin bu ranzaya kalıcı olarak bağ olduğundan emin olun kullanmadan önce yatak"
- j) **UYARI** - "Bu ürün bir duvara veya bina yapısına takılmalıdır"
- k) **EN 747-1: 2024**. Avrupa standardı gerekliliklerini karşılar.

ИНСТРУКЦИИ

ВАЖНО - ПРОЧИТАЙТЕ ВНИМАТЕЛЬНО - СОХРАНИТЕ БУДУЩУЮ ССЫЛКУ

- a) **ПРЕДУПРЕЖДЕНИЕ** - Высокие кровати и верхняя кровать двухъярусных кроватей не подходят для детей младше шести лет из-за риска получения травмы в результате падения;
- b) **ПРЕДУПРЕЖДЕНИЕ** - двухъярусные кровати и высокие кровати могут представлять серьезную опасность травмирования от удушья, если их неправильно использовать. Никогда не прикрепляйте и не подвешивайте предметы к какой-либо части двухъярусной кровати, например, которые не предназначены для использования с кроватью, но не ограничиваются веревками, веревками, шнурами, крючками, ремнями и сумками.
- c) **ПРЕДУПРЕЖДЕНИЕ** - Дети могут оказаться в ловушке между кроватью и стеной, крышей, наклонить потолок к смежным предметам мебели (например, шкафом) и т.п. Во избежание риска получения серьезных травм расстояние между верхним защитным барьером и прилегающей конструкцией не должно превышать 75 мм или должно быть более 230 мм.
- d) **ПРЕДУПРЕЖДЕНИЕ** - не используйте двухъярусную кровать / высокую кровать, если какая-либо конструктивная часть сломана или отсутствует; Запасные части между запросами от производителя или магазина.
- e) обязательно всегда следовать инструкциям по установке и использованию изготовителем.
- f) Рекомендуемый размер матраса, который будет использоваться с кроватью, составляет 200 см x 90 см, максимальная толщина матраса: **10 см**.
- g) Необходимо проветривать помещение, чтобы поддерживать низкий уровень влаги и предотвращать образование плесени в ложе и на его периферии.
- h) Соединительные устройства всегда должны быть надежно затянуты и регулярно проверяться. Затянуть при необходимости.
- i) **ПРЕДУПРЕЖДЕНИЕ** - "Всегда убедитесь, что платформа и лестница/лесница постоянно прикреплены к этой койке кровати перед использованием"
- j) **ПРЕДУПРЕЖДЕНИЕ** - "этот продукт должен быть прикреплен к стене или строительной конструкции"
- k) Соответствует требованиям Европейского стандарта NC Safety **EN 747-1: 2024**

English

IMPORTANT ! KEEP FOR FUTURE REFERENCE : READ CAREFULLY

- To be assembled by an adult. Assembly must be checked by an adult before use
- WARNING ! Keep all screws, small parts and plastic bags out of the reach of children
- Properly identify all parts before assembling
- Never use your item if any of its parts are broken or missing
- Should any problems arise, please contact our After Sales Service
- Manufacturer's instructions shall be followed at all times
- Care: Clean with a soft, dry cloth. In case of larger stains, carefully rub with a slightly damp, non-abrasive sponge
- Avoid the risk of fire by not placing furniture near sources of ignition or hot items
- Do not jump on the bed

Deutsch

WICHTIG ! ZUM SPÄTEREN NACHSCHLAGEN AUFBEWAHREN: SORGFÄLTIG LESEN

- Muss von einem Erwachsenen zusammengebaut werden. Der Zusammenbau muss vor dem Gebrauch von einem Erwachsenen überprüft werden
- WARNUNG! Bewahren Sie alle Schrauben, Kleinteile und Plastikbeutel außerhalb der Reichweite von Kindern auf
- Kennzeichnen Sie vor dem Zusammenbau alle Teile richtig
- Benutzen Sie Ihren Artikel niemals, wenn Teile gebrochen sind oder fehlen
- Sollten Probleme auftreten, wenden Sie sich bitte an unseren Kundendienst
- Die Anweisungen des Herstellers sind stets zu befolgen
- Pflege: Mit einem weichen, trockenen Tuch reinigen. Bei größeren Flecken vorsichtig mit einem leicht feuchten, nicht scheuernden Schwamm abreiben. nicht scheuernden Schwamm
- Vermeiden Sie die Gefahr eines Brandes, indem Sie die Möbel nicht in der Nähe von Zündquellen oder heißen Gegenständen aufstellen
- Nicht auf das Bett springen

Français

IMPORTANT ! CONSERVER POUR RÉFÉRENCE ULTÉRIEURE : LIRE ATTENTIVEMENT

- Le montage doit être effectué par un adulte. Le montage doit être vérifié par un adulte avant Utilisation
- ATTENTION ! Tenir les vis, les petites pièces et les sachets en plastique hors de portée des enfants
- Identifiez correctement toutes les pièces avant de les assembler
- N'utilisez jamais votre article si l'une de ses pièces est cassée ou manquante
- En cas de problème, veuillez contacter notre service après-vente
- Les instructions du fabricant doivent être respectées à tout moment
- Entretien : nettoyer avec un chiffon doux et sec. En cas de taches plus importantes, frotter soigneusement avec une éponge non abrasive légèrement humide. légèrement humide et non Abrasive
- Évitez les risques d'incendie en ne plaçant pas les meubles à proximité de sources d'inflammation ou d'objets chauds
- Ne pas sauter sur le lit

Italiano

IMPORTANTE! CONSERVARE PER RIFERIMENTO FUTURO: LEGGERE ATTENTAMENTE

- Deve essere assemblato da un adulto. L'assemblaggio deve essere controllato da un adulto prima dell'uso
- **ATTENZIONE!** Tenere tutte le viti, le piccole parti e i sacchetti di plastica fuori dalla portata dei bambini
- Identificare correttamente tutte le parti prima dell'assemblaggio
- Non utilizzare mai l'articolo se alcune parti sono rotte o mancanti
- In caso di problemi, si prega di contattare il nostro Servizio Post Vendita
- Le istruzioni del produttore devono essere sempre seguite
- Cura: Pulire con un panno morbido e asciutto. In caso di macchie più estese, strofinare accuratamente con una spugna leggermente umida e nonspugna leggermente umida e non abrasiva
- Evitare il rischio di incendio, non collocando i mobili vicino a fonti di accensione o a oggetti caldi
- Non saltare sul letto

Español

¡ IMPORTANTE ! CONSERVELO PARA FUTURAS CONSULTAS: LEA ATENTAMENTE

- Debe ser montado por un adulto. El montaje debe ser comprobado por un adulto antes del uso
- ADVERTENCIA** Mantenga todos los tornillos, piezas pequeñas y bolsas de plástico fuera del alcance de los niños.
- Identifique correctamente todas las piezas antes de montarlas
 - Nunca utilice su artículo si alguna de sus piezas está rota o falta
 - Si surge algún problema, póngase en contacto con nuestro Servicio Postventa
 - Las instrucciones del fabricante deben seguirse en todo momento
 - Cuidado: Limpiar con un paño suave y seco. En caso de manchas más grandes, frote cuidadosamente con una esponja no abrasiva ligeramente humedecida.
 - Evite el riesgo de incendio no colocando los muebles cerca de fuentes de ignición u objetos calientes.
 - No saltar sobre la cama.

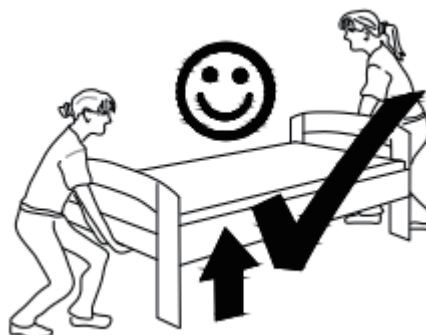
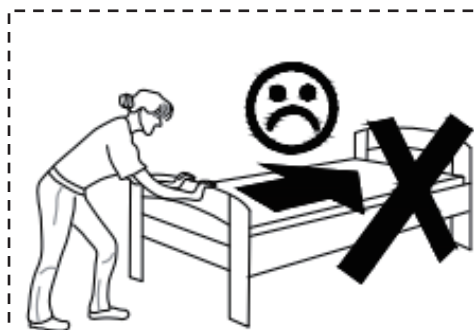

DE: Vor dem Einbau die Schrauben in die Löcher stecken und festziehen, aber nicht bis 100%, 70% bis 80% anziehen reicht aus. Schließlich, nachdem alle Schrauben installiert sind, ziehen Sie alle Schrauben auf 100%. Wenn Sie auf diese Probleme stoßen, wie z. B. Fehlausrichtung der Löcher oder Unfähigkeit, bestimmte Teile zu installieren, überprüfen Sie bitte, ob die Schrauben korrekt verwendet werden und passen Sie die Dichtigkeit der Schrauben an.

UK: Before installation, insert the screws into the holes and tighten them, but do not tighten them to 100%, 70% to 80% is sufficient. Finally, after all screws are installed, tighten all screws to 100%. If you encounter these issues, such as if the holes cannot be aligned or some parts cannot be installed, please check if the screws are used correctly and adjust the tightness of the screws.







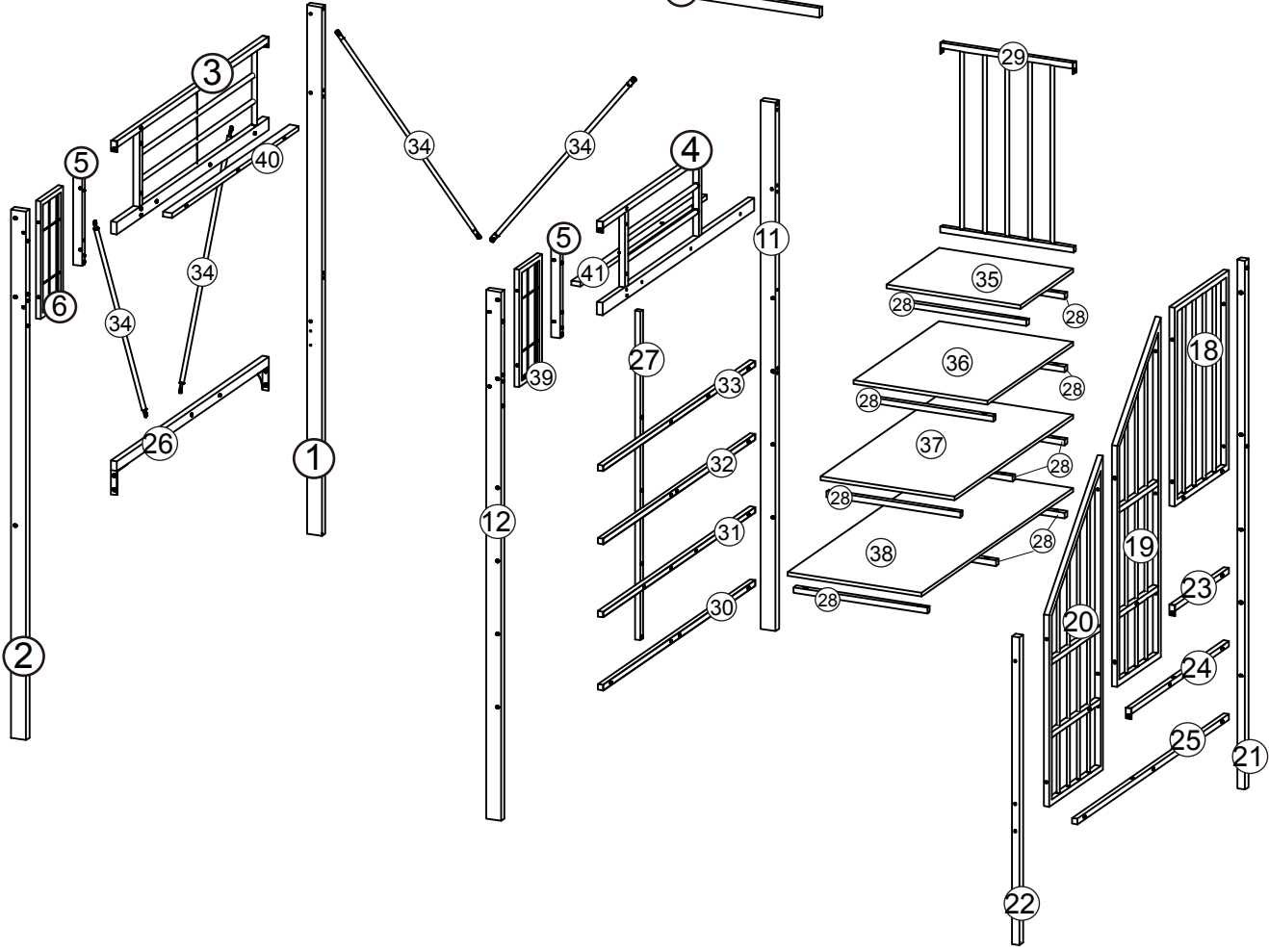
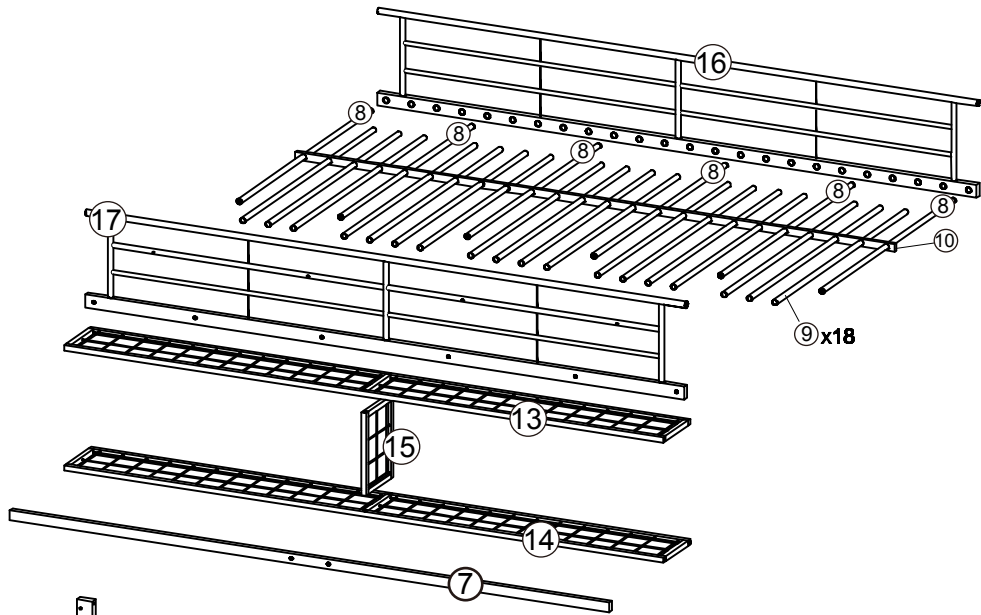



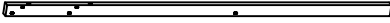



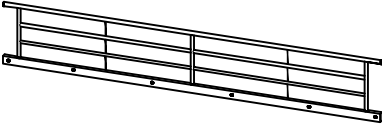
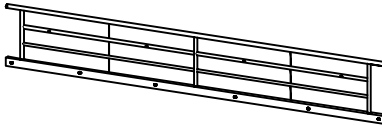

FR: Insérer la vis dans le trou avant la fin de l'assemblage, serrer la vis, mais ne pas serrer à 100%, 70% ~ 80% est correct. Enfin, une fois que toutes les vis sont bien serrées, toutes les vis sont serrées à 100%. Si vous rencontrez ces problèmes, par exemple si les trous ne sont pas alignés ou si certaines pièces ne peuvent pas être montées, vérifiez que les vis sont utilisées correctement et Ajustez leur serrage.

Importeur	Decobus Handel GmbH		
Adresse	Innungsstraße 9, 21244 Buchholz Deutschland		
URL	https://www.decobusgroup.de		
Hersteller	XIAMEN GRACE HOME DESIGN IMPORT AND EXPORT CO., LTD.		
Adresse	ZHANGZHOU LONGHAI FLOATING PALACE		
Email	gracehome001@163.com		
<table border="1" style="display: inline-table; vertical-align: middle;"> <tr> <td>EC</td> <td>REP</td> </tr> </table>	EC	REP	Decobus Handel GmbH Innungsstraße 9, 21244 Buchholz Deutschland https://www.decobusgroup.de
EC	REP		
Standard	EN 747-1: 2024		
	Hergestellt in China		

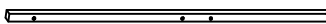

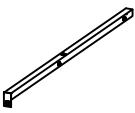
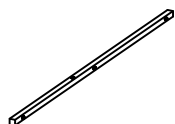

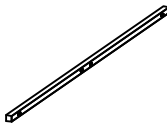
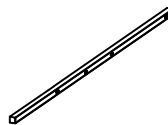
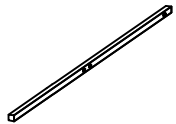
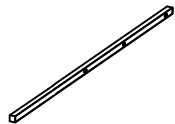

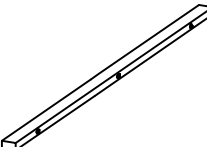
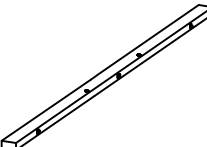
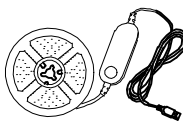

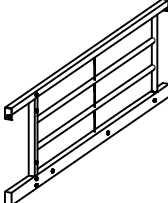
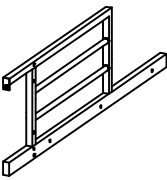

Detail View





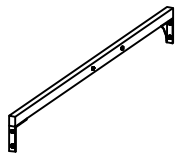

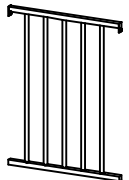
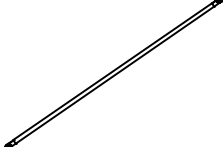

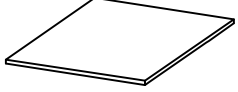
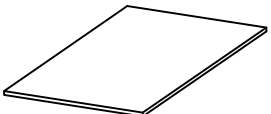
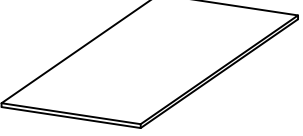



PART LIST FOR N636P443754

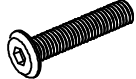
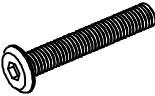

<p>1</p>  <p>1PC</p>	<p>2</p>  <p>1PC</p>	<p>5</p>  <p>2PCS</p>
<p>6</p>  <p>1PC</p>	<p>7</p>  <p>1PC</p>	<p>10</p>  <p>1PC</p>
<p>11</p>  <p>1PC</p>	<p>12</p>  <p>1PC</p>	<p>13</p>  <p>1PC</p>
<p>14</p>  <p>1PC</p>	<p>16</p>  <p>1PC</p>	<p>17</p>  <p>1PC</p>
<p>19</p>  <p>1PC</p>	<p>21</p>  <p>1PC</p>	<p>22</p>  <p>1PC</p>
<p>23</p>  <p>1PC</p>	<p>24</p>  <p>1PC</p>	<p>25</p>  <p>1PC</p>
<p>27</p>  <p>1PC</p>	<p>30</p>  <p>1PC</p>	<p>31</p>  <p>1PC</p>
<p>32</p>  <p>1PC</p>	<p>33</p>  <p>1PC</p>	<p>39</p>  <p>1PC</p>
<p>40</p>  <p>1PC</p>	<p>41</p>  <p>1PC</p>	<p>N</p>  <p>1PC</p>

PART LIST FOR N636P443755

<p>3</p>  <p>1PC</p>	<p>4</p>  <p>1PC</p>	<p>8</p>  <p>6PCS</p>
<p>9</p>  <p>18PCS</p>	<p>15</p>  <p>1PC</p>	<p>18</p>  <p>1PC</p>
<p>20</p>  <p>1PC</p>	<p>26</p>  <p>1PC</p>	<p>28</p>  <p>10PCS</p>
<p>29</p>  <p>1PC</p>	<p>34</p>  <p>4PCS</p>	<p>35</p>  <p>1PC</p>
<p>36</p>  <p>1PC</p>	<p>37</p>  <p>1PC</p>	<p>38</p>  <p>1PC</p>

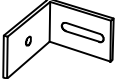
HARDWARE LIST FOR N636P443754

<p>A</p>  <p>M6*15mm 10PCS</p>	<p>B</p>  <p>M6*20mm 16PCS</p>	<p>C</p>  <p>M6*28mm 36PCS</p>
<p>D</p>  <p>M6*35mm 17PCS</p>	<p>E</p>  <p>M6*40mm 28PCS</p>	<p>F</p>  <p>M6*45mm 20PCS</p>
<p>G</p>  <p>M6*70mm 23PCS</p>	<p>H</p>  <p>M6*17mm 31PCS</p>	<p>I</p>  <p>M4 2PCS</p>
<p>J</p>  <p>2PCS</p>	<p>K</p>  <p>2PCS</p>	<p>L</p>  <p>Φ4*35mm 2PCS</p>
<p>M</p>  <p>2PCS</p>		

<div data-bbox="129 181 169 226" style="border: 1px solid black; padding: 2px; text-align: center;">A</div> <div data-bbox="295 257 422 369" style="text-align: center;">  M6*15mm 10PCS </div>	<div data-bbox="566 181 606 226" style="border: 1px solid black; padding: 2px; text-align: center;">B</div> <div data-bbox="718 257 845 369" style="text-align: center;">  M6*20mm 16PCS </div>
---	---

DE:Bitte beachten Sie, dass die Formen der Schrauben A und B ähnlich sind.



Bitte installieren Sie entsprechend der Anleitung und unterscheiden Sie sie!

UK>Please note that the shapes of screws A and B are similar.

Please install according to the instructions and distinguish them!

FR:Notez que les vis A et B ont des formes similaires.

Veillez les installer en suivant les instructions pour les séparer!

<div data-bbox="134 936 173 981" style="border: 1px solid black; padding: 2px; text-align: center;">D</div> <div data-bbox="295 985 422 1120" style="text-align: center;">  M6*35mm 17PCS </div>	<div data-bbox="566 936 606 981" style="border: 1px solid black; padding: 2px; text-align: center;">E</div> <div data-bbox="734 985 861 1120" style="text-align: center;">  M6*40mm 28PCS </div>	<div data-bbox="1005 936 1045 981" style="border: 1px solid black; padding: 2px; text-align: center;">F</div> <div data-bbox="1181 985 1308 1120" style="text-align: center;">  M6*45mm 20PCS </div>
---	---	---

DE:Bitte beachten Sie, dass die Formen der Schrauben D und E und F ähnlich sind.

Bitte installieren Sie entsprechend der Anleitung und unterscheiden Sie sie!

UK>Please note that the shapes of screws D and E and F are similar.

Please install according to the instructions and distinguish them!

FR:Notez que les vis D et E et F ont des formes similaires.

Veillez les installer en suivant les instructions pour les séparer!

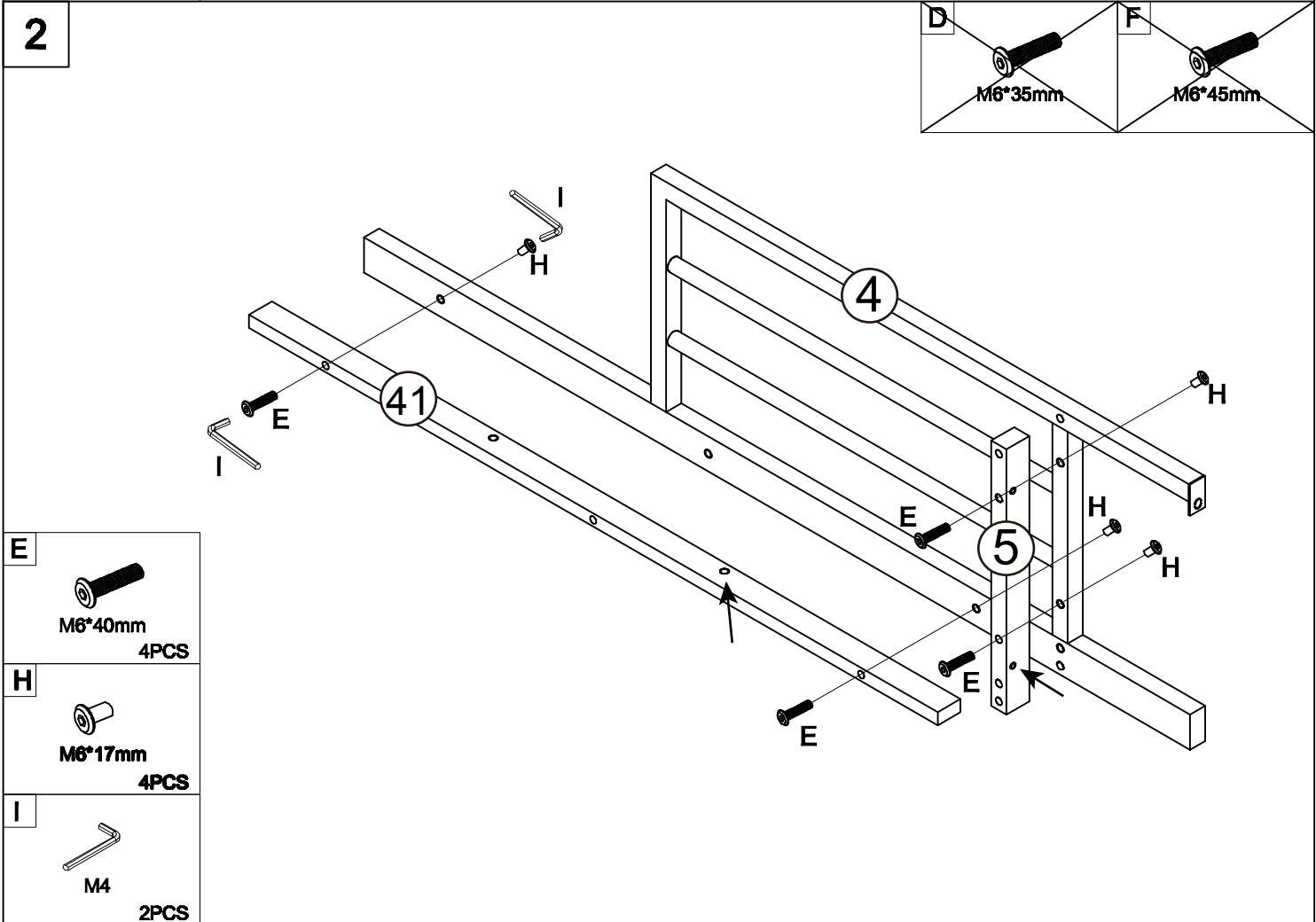
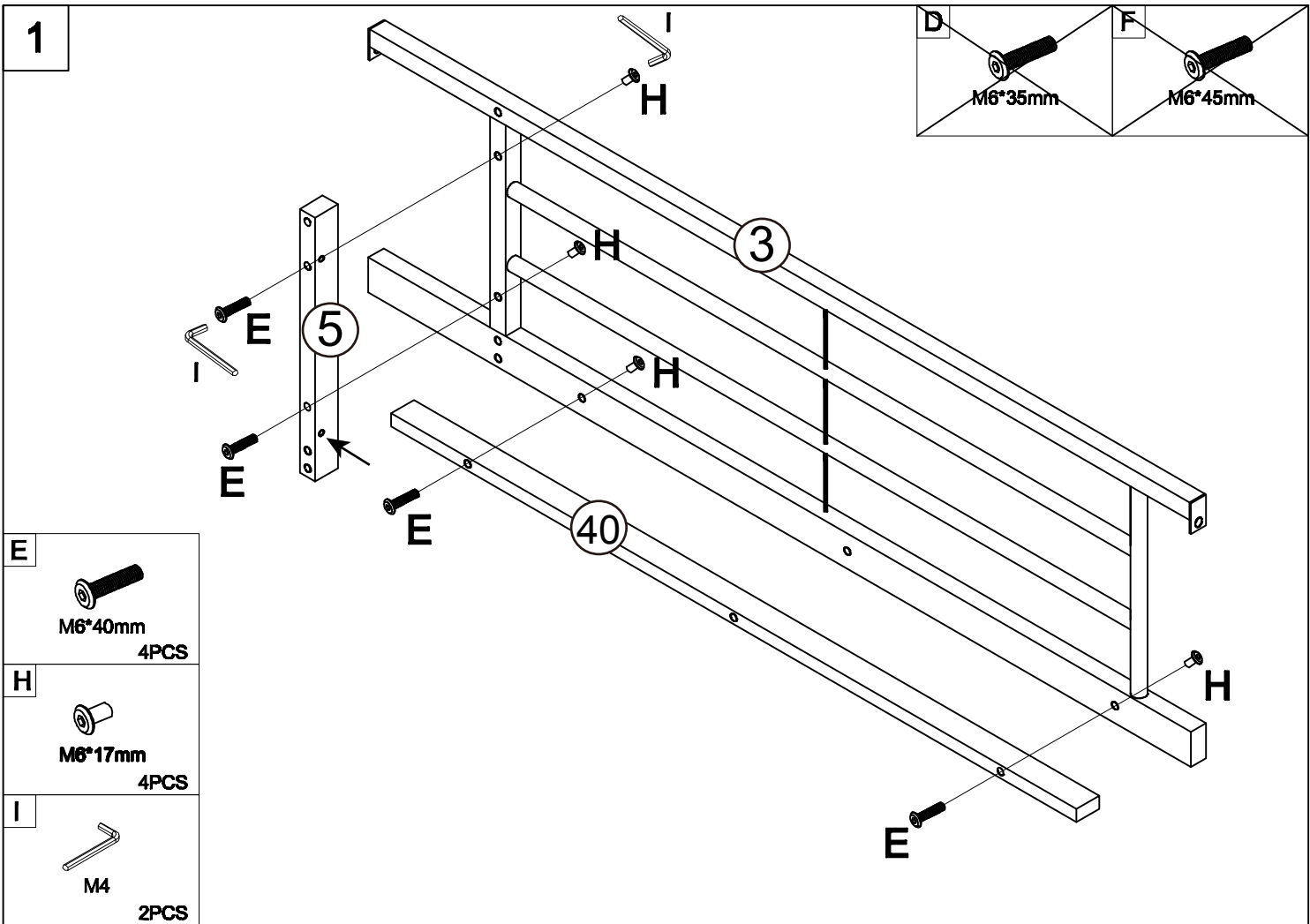

3

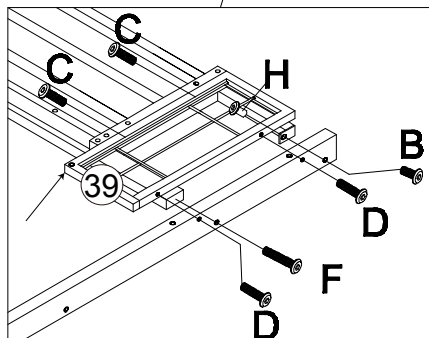
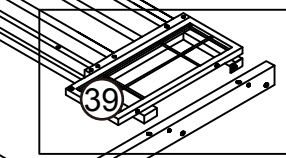
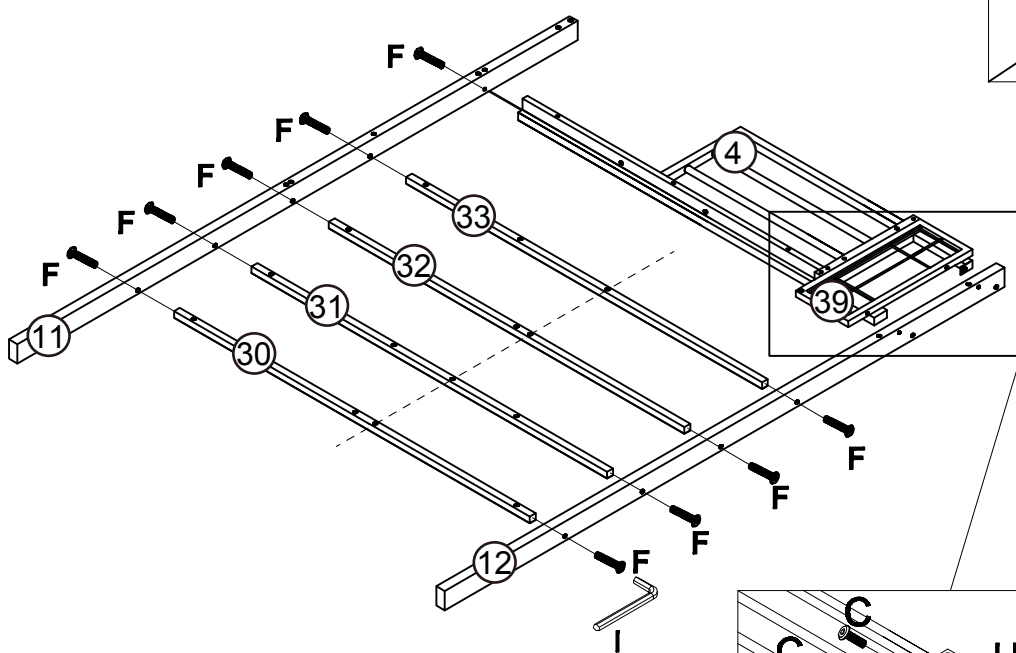
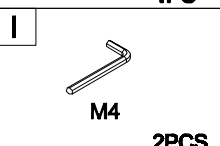
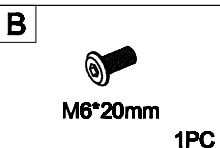
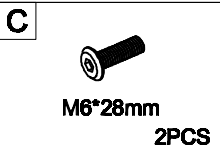
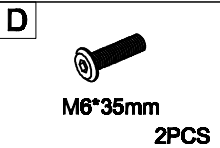
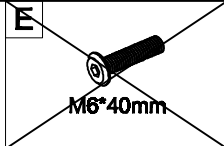

4

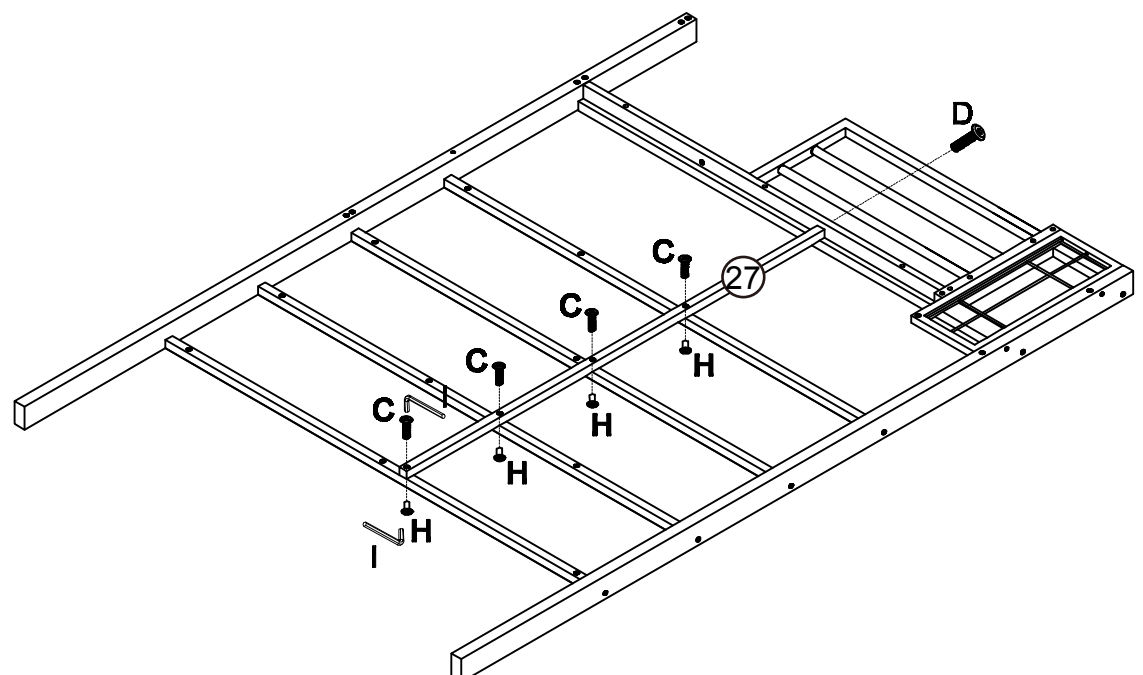
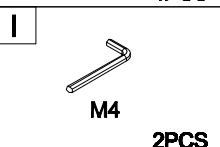
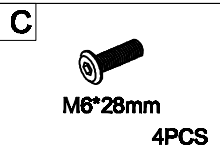
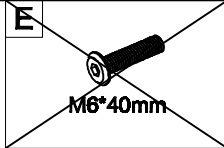

5

F
M6*45mm
4PCS

D
M6*35mm
2PCS

C
M6*28mm
2PCS

B
M6*20mm
2PCS

A
M6*15mm
4PCS

H
M6*17mm
2PCS

I
M4
2PCS

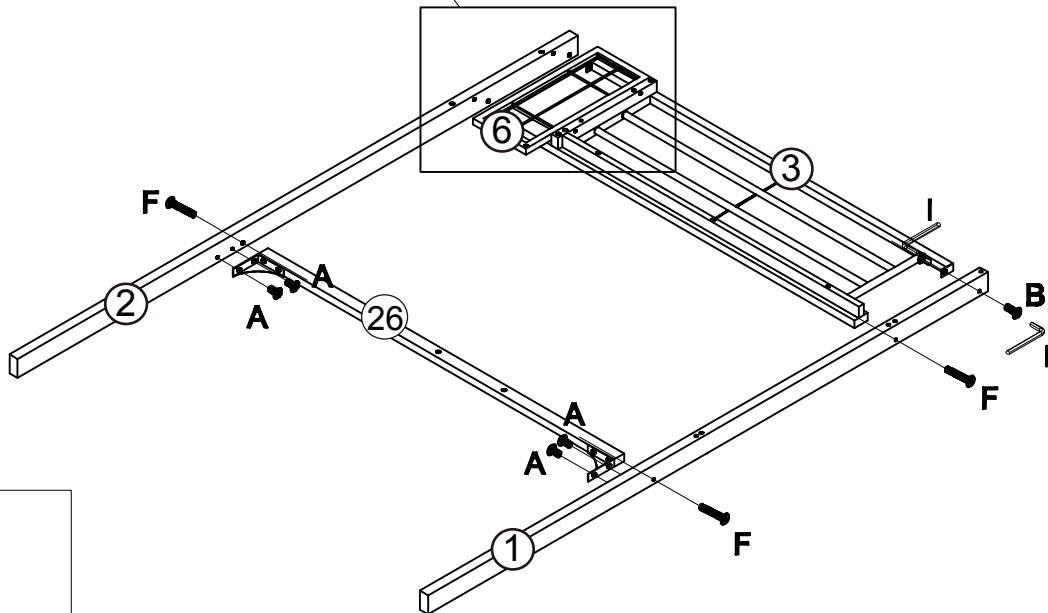
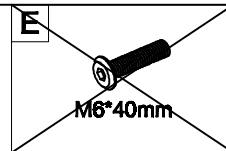
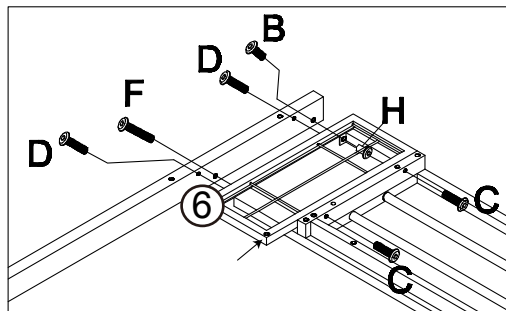

6

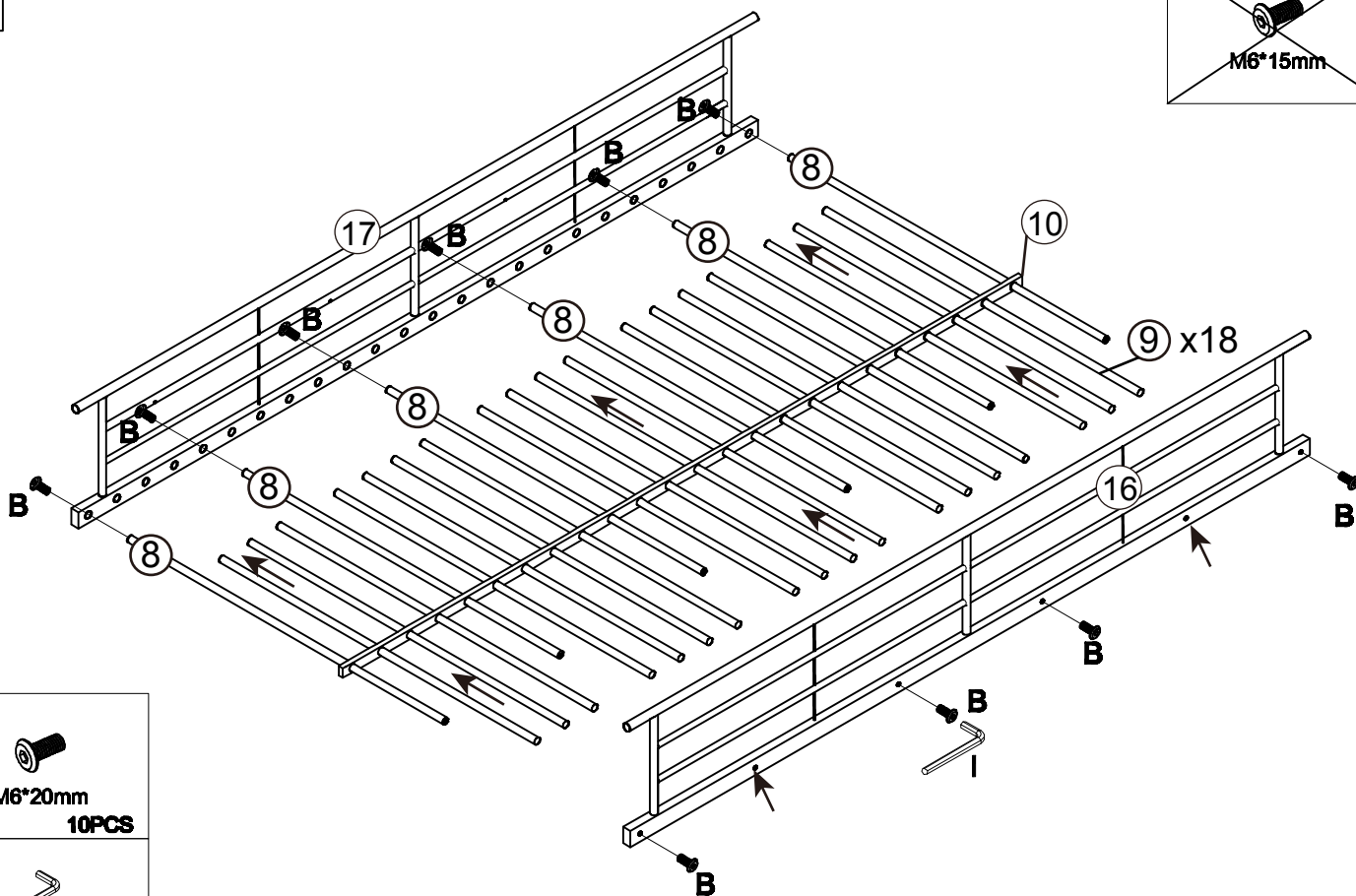
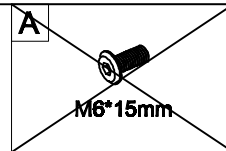

B
M6*20mm
10PCS

I
M4
2PCS

7

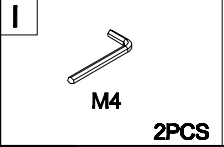
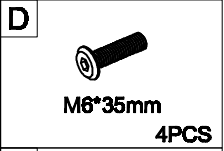
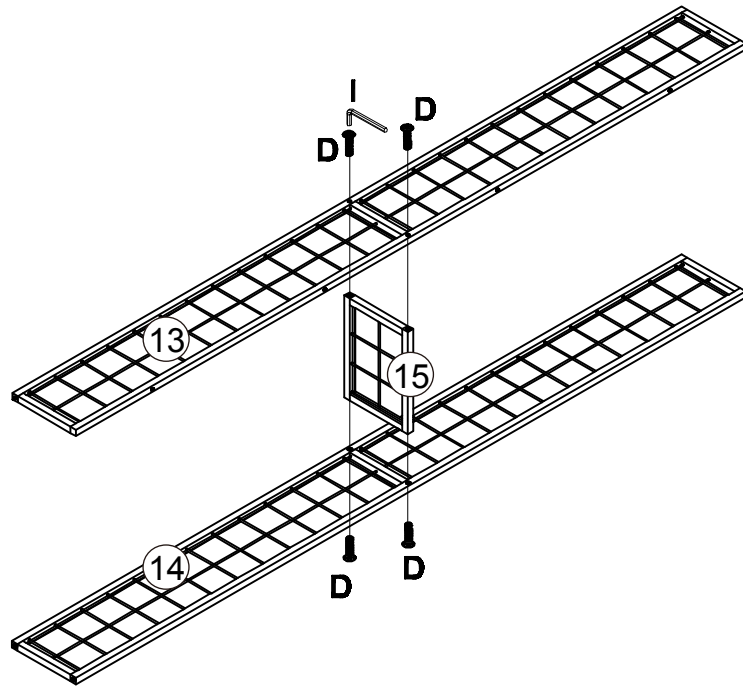
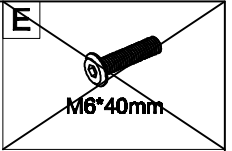

8

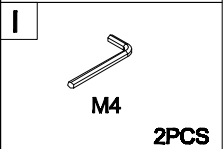
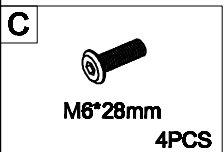
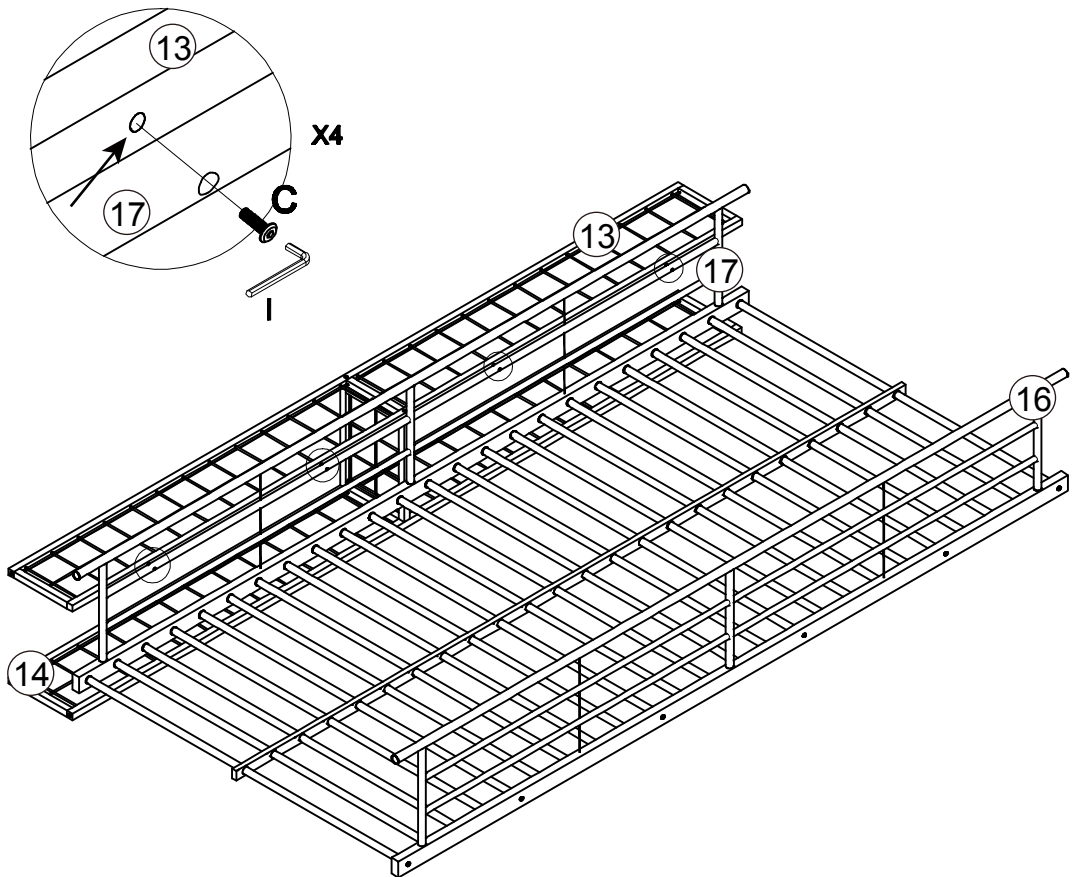

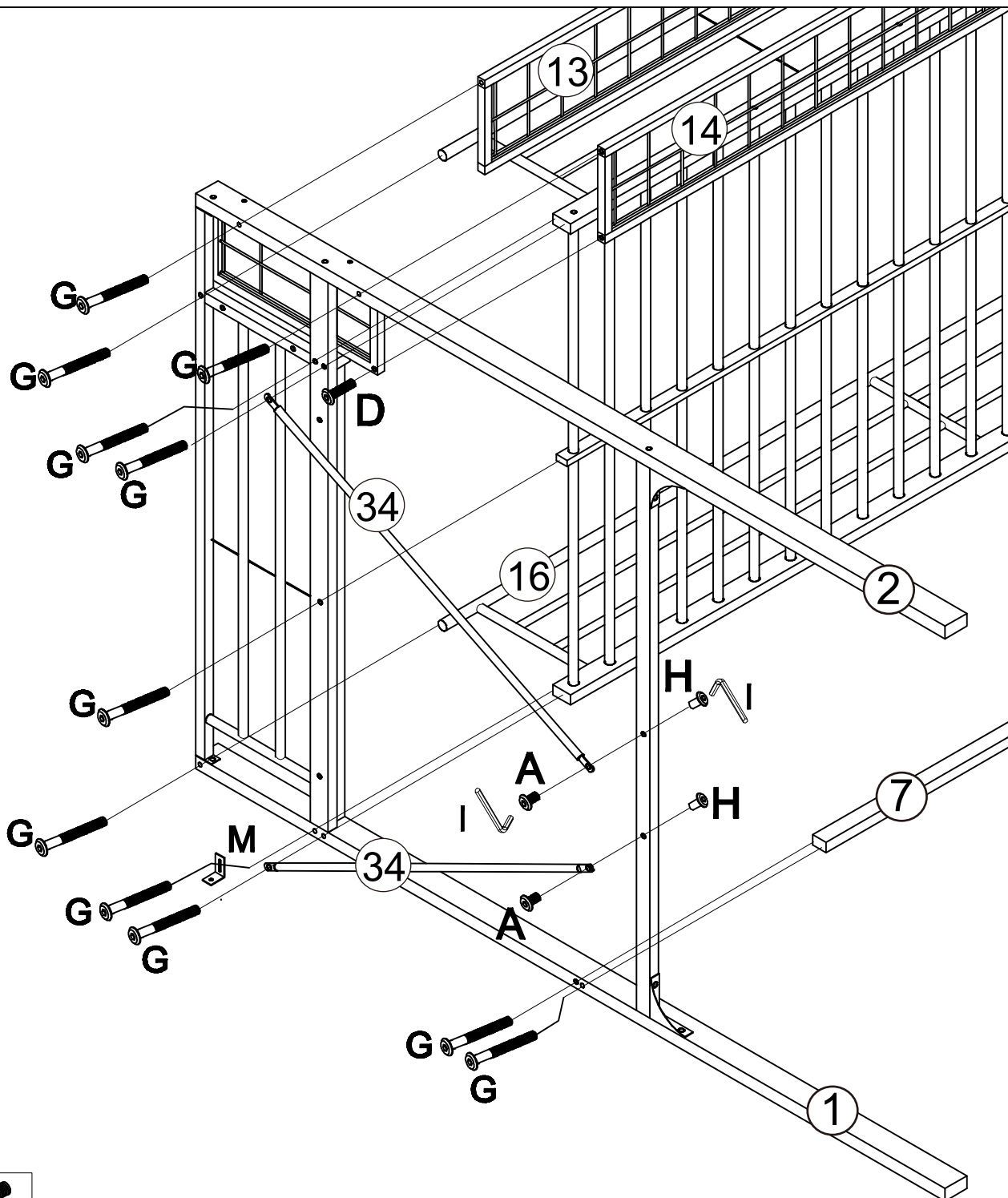

G



M6*70mm
11PCS

D



M6*35mm
1PC

A



M6*15mm
2PCS

I



M4
2PCS

H



M6*17mm
2PCS

M



1PC

B



M6*20mm

E



M6*40mm

10

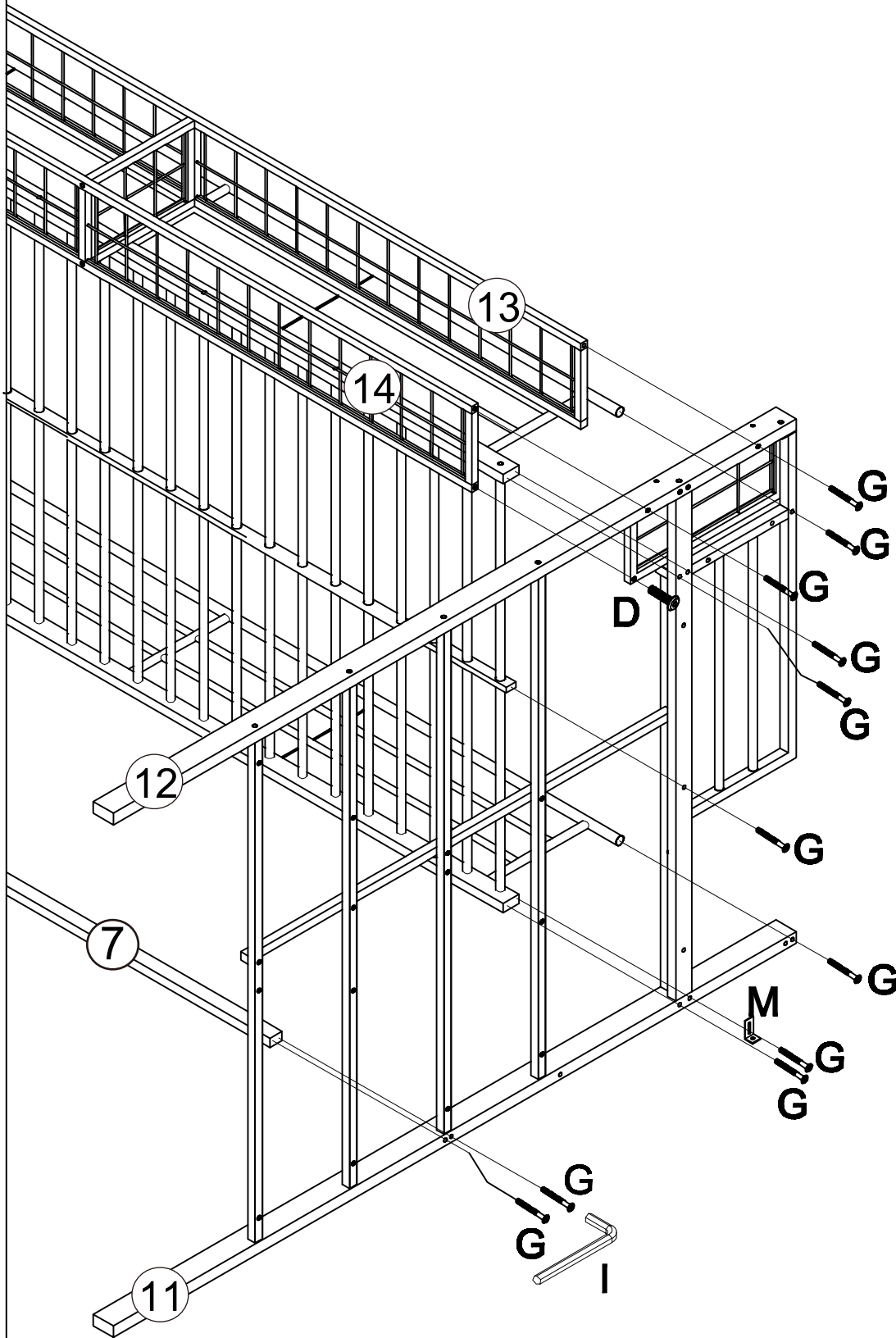
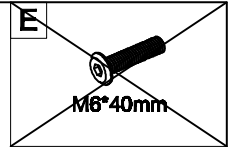

M		1PC
G		M6*70mm 11PCS
D		M6*35mm 1PC
I		M4 2PCS

11

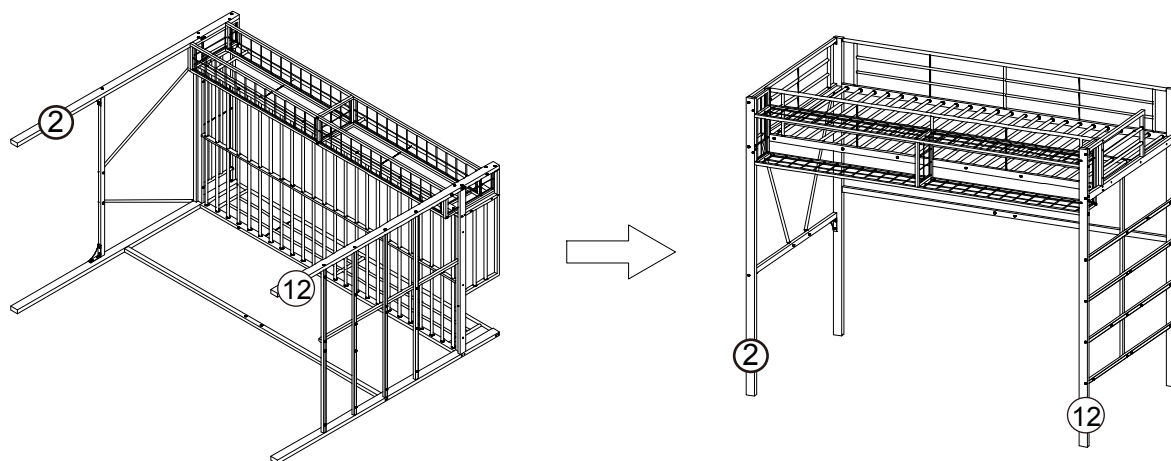

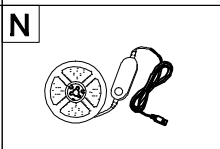
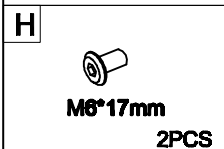
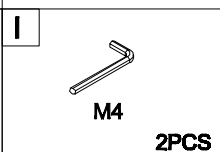
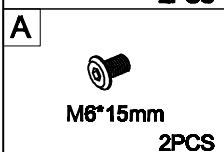
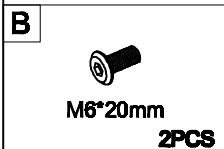
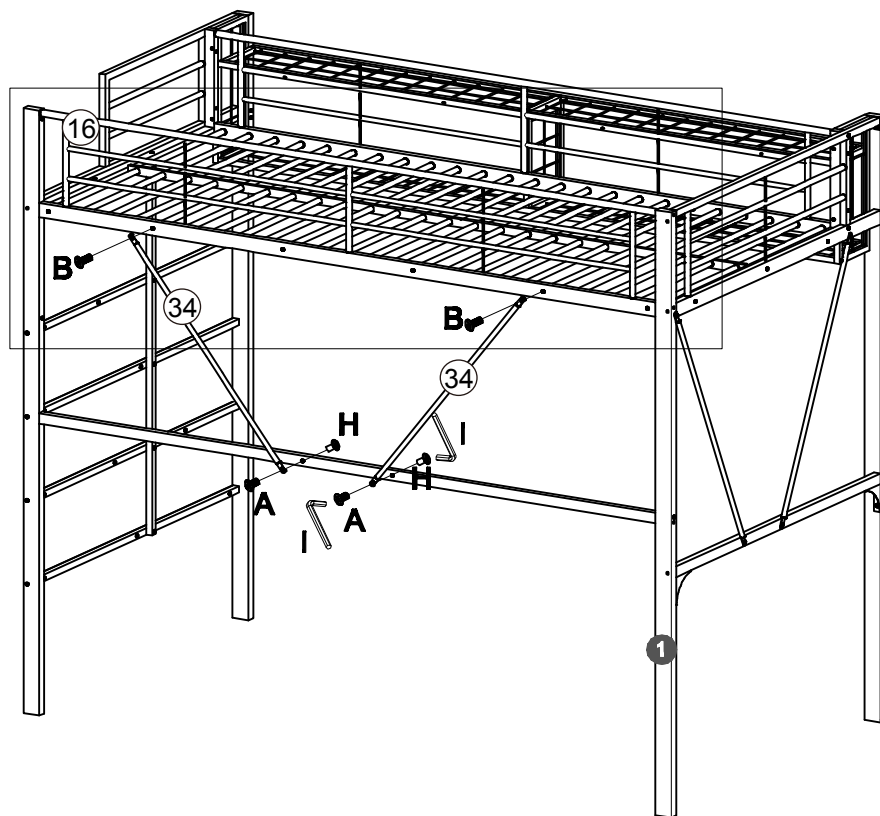
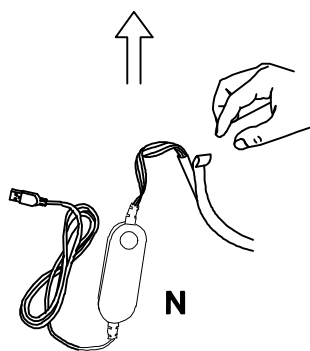
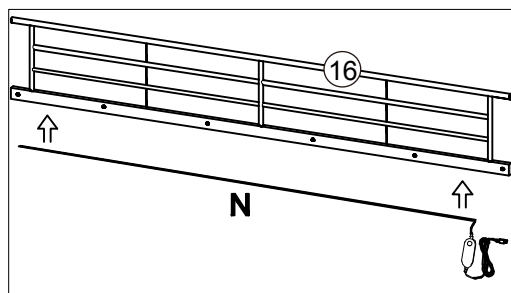

12



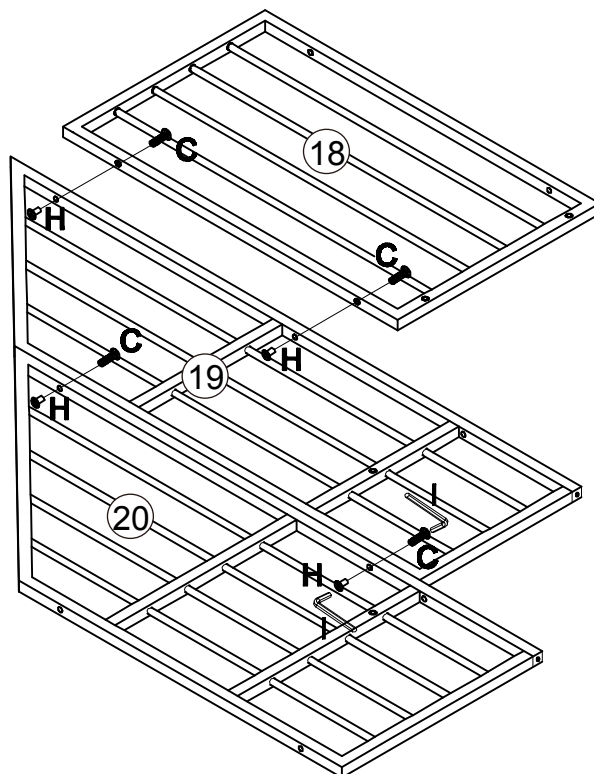

Steuerung Per knopfdruck Oder über die APP
Control via a push-button switch or through the APP
Contrôle avec commutateur de presse ou APP

13





C

 M6*28mm
 4PCS

H

 M6*17mm
 4PCS

I

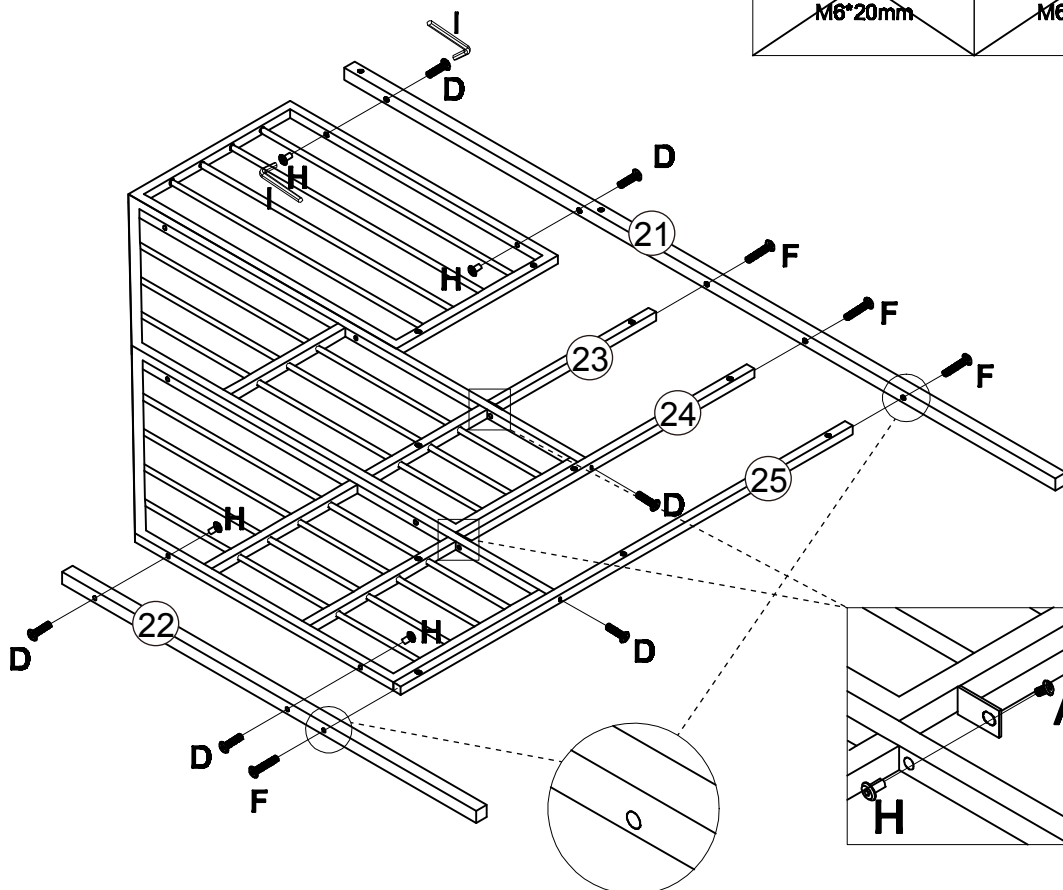
 M4
 2PCS

14

B  M6*20mm
E  M6*40mm



F

 M6*45mm
 4PCS

D

 M6*35mm
 6PCS

A

 M6*15mm
 2PCS

H

 M6*17mm
 6PCS

I

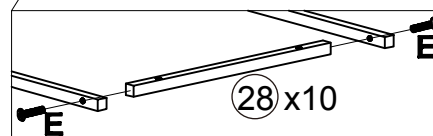
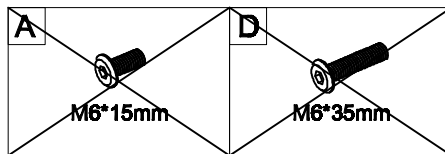
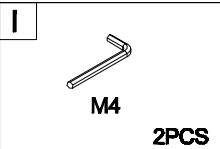
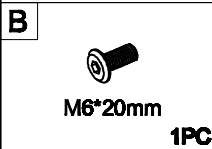
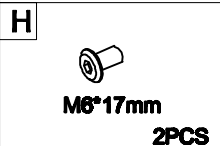
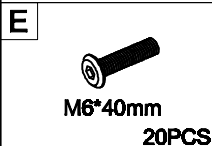
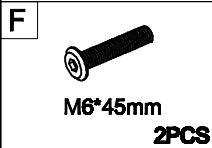
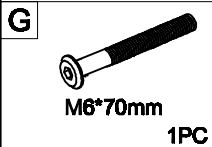
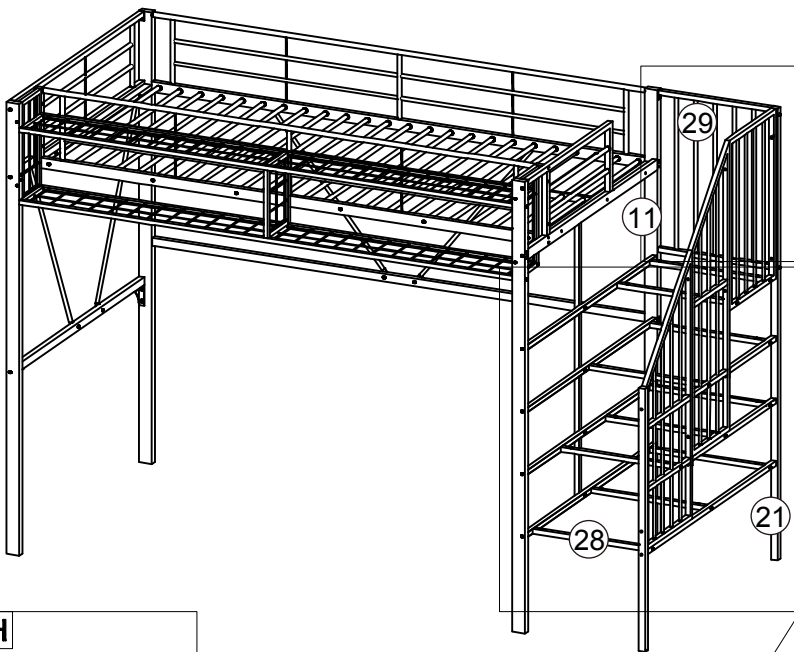
 M4
 2PCS

20

15

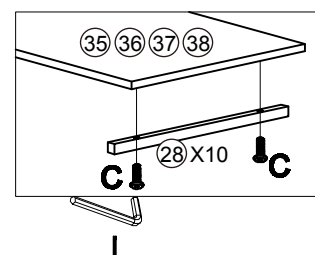
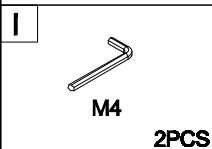
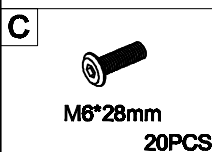
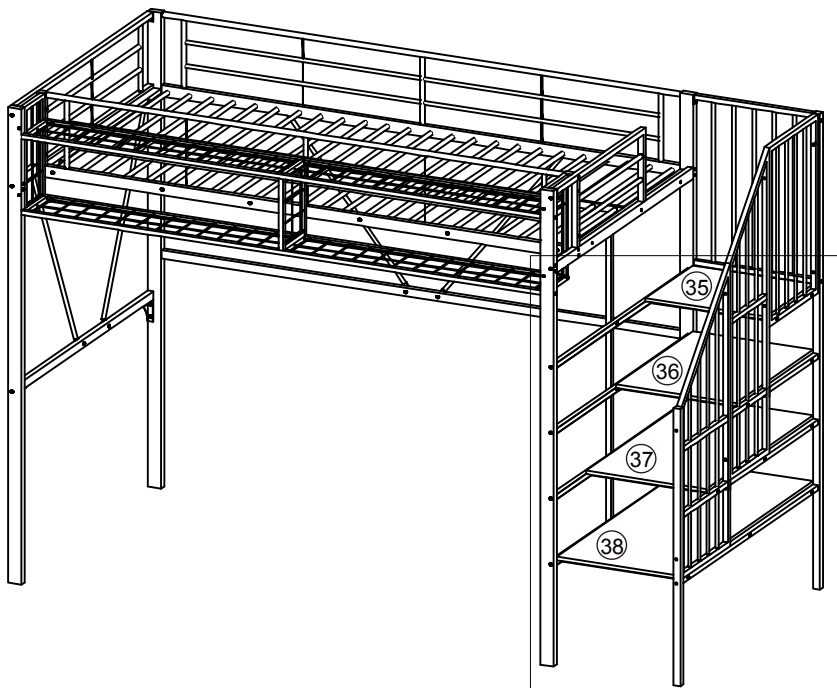

16



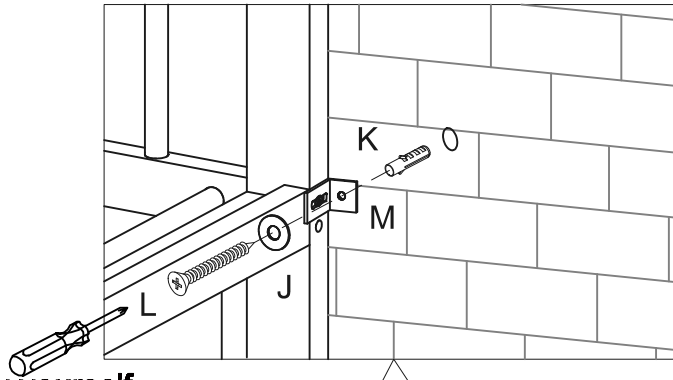

Please prepare by yourself.
 Veuillez préparer par vous-même.
 Bitte bereiten Sie selbst vor.

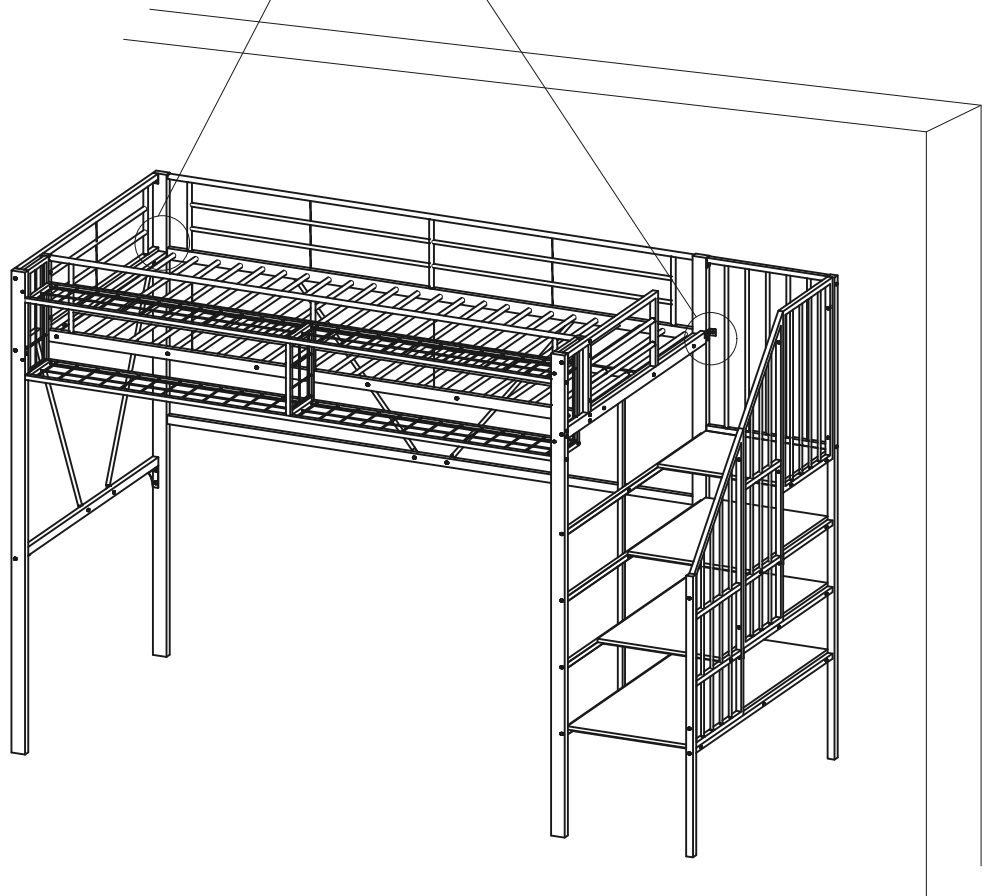

J



2PCS

K



2PCS

L

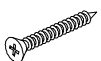

Φ4*35mm

2PCS

LotusLantern APP Manual

1. Software Overview

1.1 Overview

LotusLantern is a mobile APP to control LED strip by both Apple and Android phones.

The traditional control ways like infrared, 433MHz, 2.4GHz and others old wired ways will be replaced by mobile phone control way with convenient, powerful and scalable features.

Through this mobile APP, you can not only control the color, brightness and color temperature of the LED strips but also set up all kinds of fancy flash mode ; Also this APP can change the light of the LED strip according to the rhythm of the music. This APP can set and control several LED strips through Bluetooth and the operation is very simple, easy to learn and easy to use.

1.2 Features

- Adjust color LED strips with 60,000 colors to change color and brightness and adjust monochrome LED strips to change brightness and color temperature
- Play music or turn on a sound playback device, you can let the light change the color and brightness with the rhythm of music, the music rhythm beautiful
- Inside multiple setting mode for color change and control LED strips without mobile
- Long distance control with omni-directional antenna, and many-to-many group control mode
- Once the connection is successful, connect automatically next time

1.3 Performance

LotusLantern APP is easy for use as well as great compatible for all kinds of smart phones; After the actual test of hundreds of mobile phones verification, the compatibility is above 95% of mobile phones in the market. APP is small and convenient, it consumes less system resources, so the requirements of the mobile configuration are low. Control delay is small, the operation feel good, light control is smooth with people's visual sense.

2. Operating Environment

This APP program requires phones of system above Android 4.3 and iOS 8.0. Mobile phone configuration is not limited.

3. Instructions

Note: Android version and iOS version download and use the same method, here in the Android version as an example.

3.1 APP Download

Scan the QR code

iOS and Android systems can download the "LotusLantern" APP by scanning the QR code. Open the browser or other tools with "Scan QR code" function, scan the "LotusLantern" QR code as below:



3.2 App Operation

- (1) Click on the LotusLantern APP icon, enter the APP page:

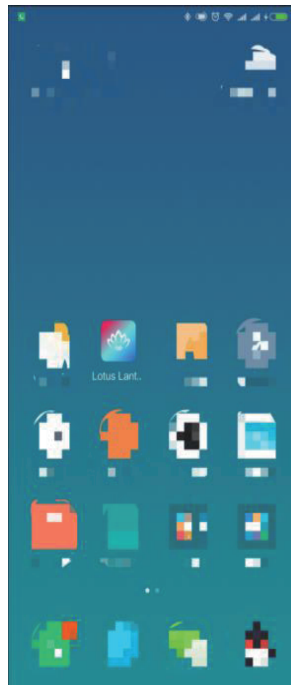

(2) After entering the APP interface, if Bluetooth is not enabled, "an application wants to enable the Bluetooth function of this device." Click [Allow]

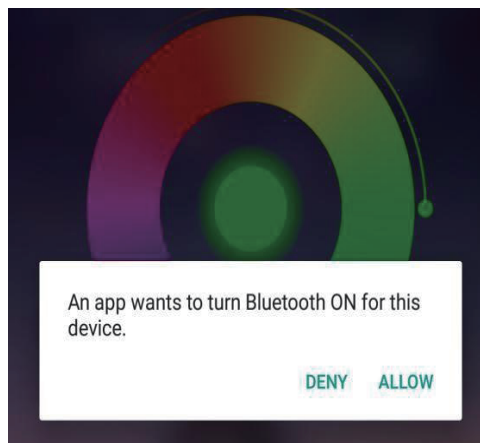

(3) switch to color and brightness interface:

Click to show the lamp list

Switch the color wheel

Display the RGB value
Click to manual adjustment view

Click to display setting view

Lamp switch button

Adjust the color

Click square icon to adjust the color

Click to shift the interface

The interface shows a central color wheel with a slider for brightness. Below the wheel, the RGB values are displayed: R 98, G 193, B 111. At the bottom, there are preset color buttons (CCT, W) and a classic color palette. A navigation bar at the very bottom contains icons for Adjust, Style, Music, Online, and Mic.

(4) click to show the lamp list, view lamp list:

Bluetooth auto connect
after search for devices

Lamp list

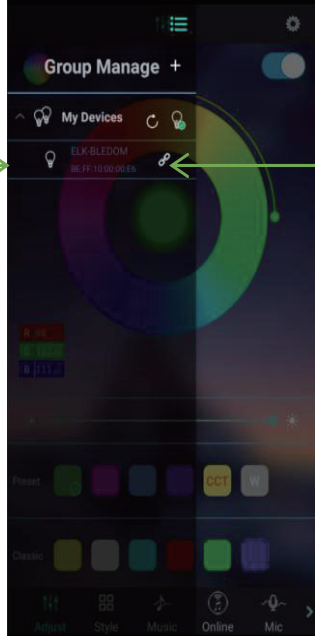

Status of device connection

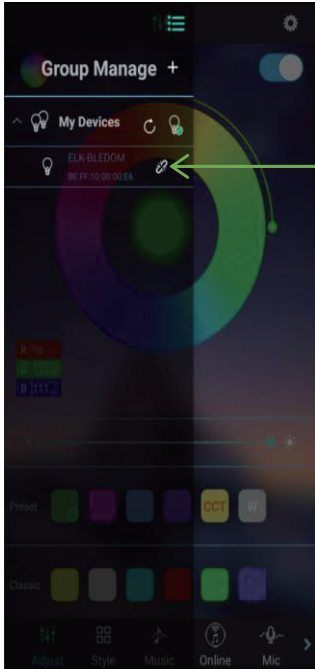

Status of device connection

(5) Click to RGB manual adjustment view:

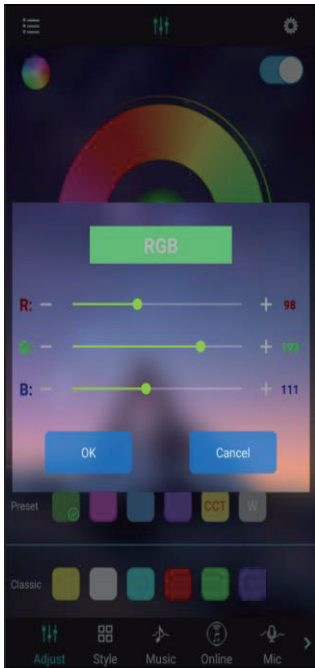

(6) switch to the mode interface:

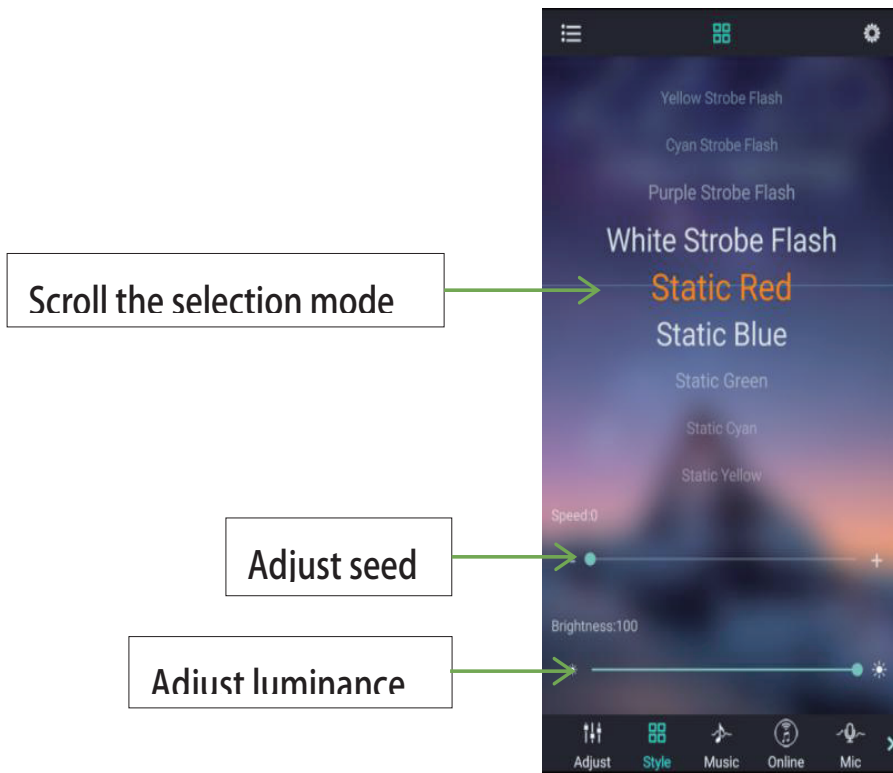

(7) switch to the music rhythm interface:

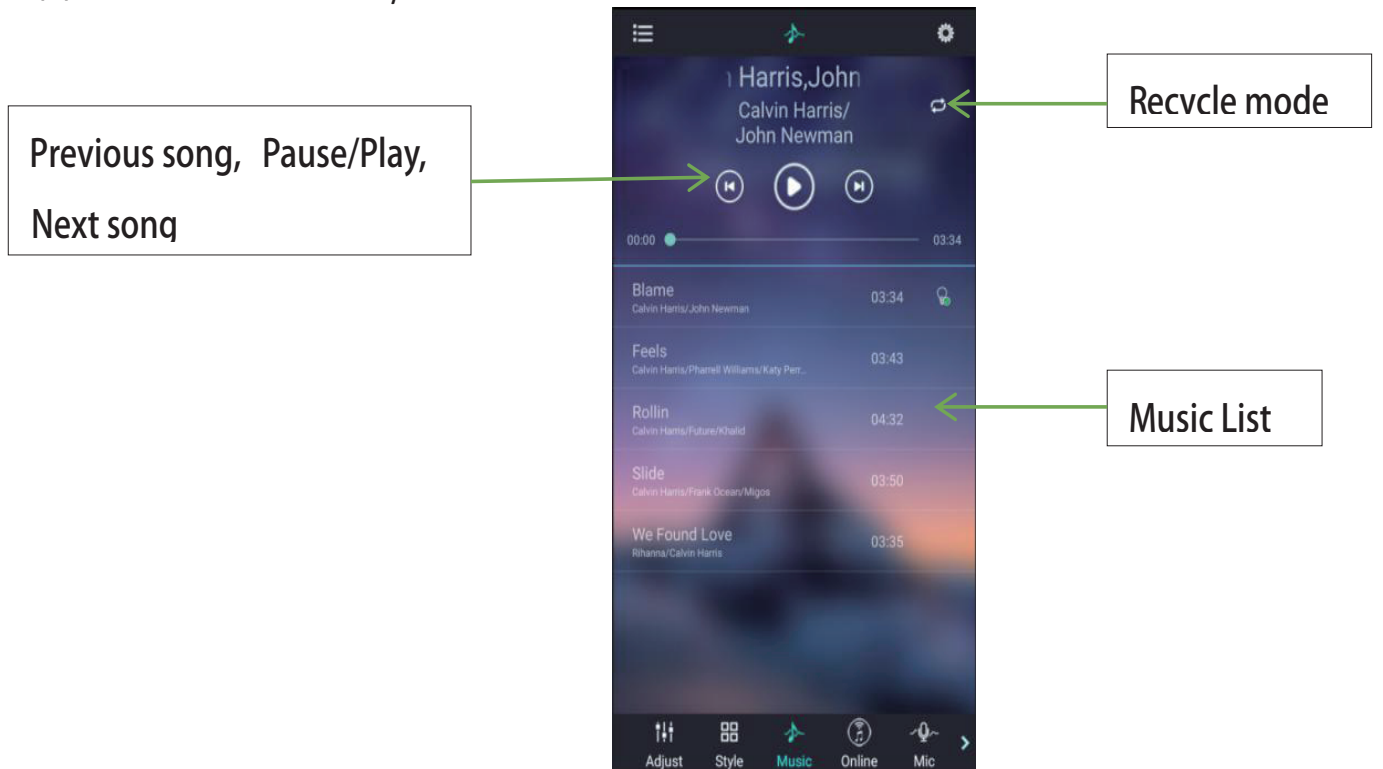

(8) Switch to the online music interface:

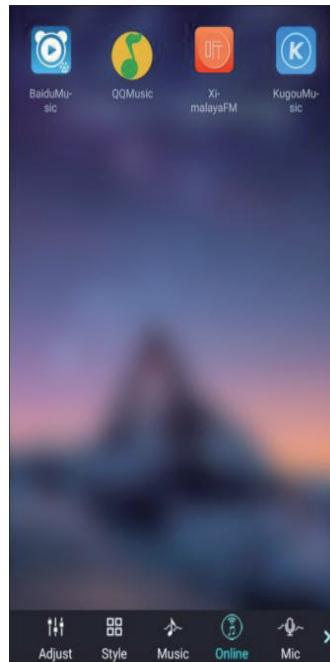

(9) Switch to the microphone rhythm interface:

Music rhythm through cell phone microphone

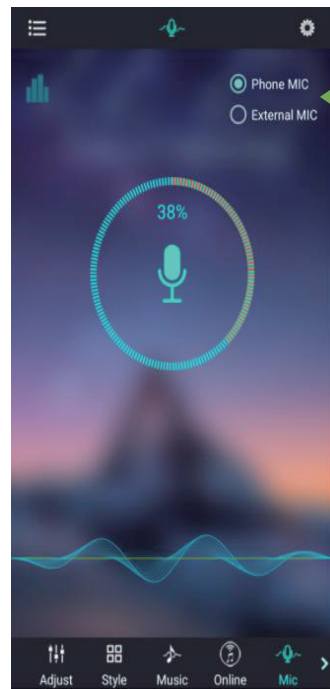

Switch phone microphone and external microphone

Music rhythm through the microphone on the product

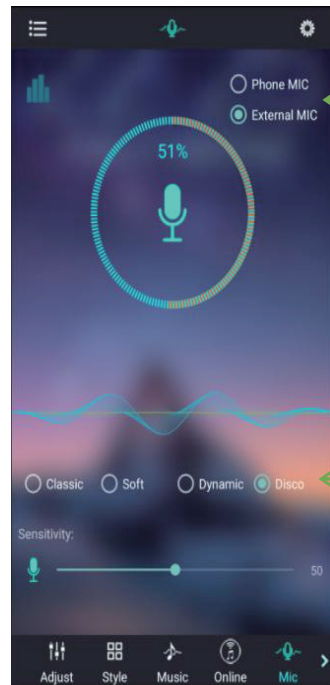

Switch phone microphone and external microphone

4-style rhythm

Change the sensitivity of MIC to match the sound

(10) Switch to the schedule interface:

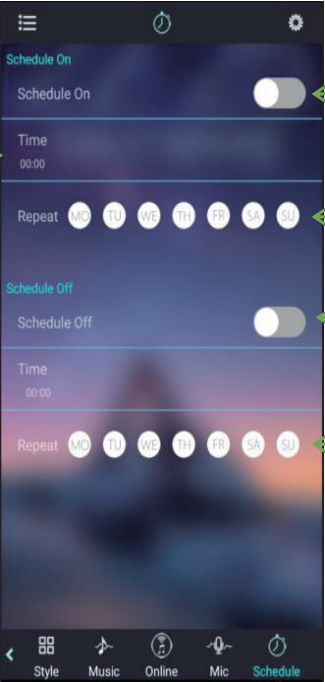

The screenshot shows a mobile application interface for scheduling lights. It is divided into two main sections: 'Schedule On' and 'Schedule Off'. Each section has a toggle switch, a 'Time' field set to '00:00', and a 'Repeat' section with seven circular buttons for days of the week (M, Tu, W, Th, Fr, Sa, Su). The 'Schedule On' section is currently active, with its toggle switch turned on. The 'Schedule Off' section is currently inactive, with its toggle switch turned off. At the bottom of the screen, there is a navigation bar with icons for 'Style', 'Music', 'Online', 'Mic', and 'Schedule'.

Set the time of Light -On

Set the time of Light -Off

Enable or disable the Light-On function

Repeat setting
No selection for once Light -On

Enable or disable the Light-Off function

Repeat setting
No selection for once Light -Off

(11) Switch to the modify pin sequence interface:

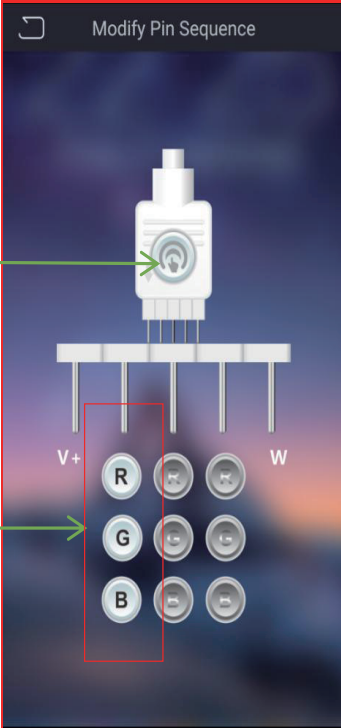

The screenshot shows a mobile application interface for modifying a pin sequence. The title is 'Modify Pin Sequence'. At the top, there is a white connector icon with a circular arrow around it. Below it, there is a row of seven pins. The first pin is labeled 'V+' and the last pin is labeled 'W'. Below the pins, there is a grid of color selection buttons. The first column has buttons for 'R', 'G', and 'B'. The second and third columns have buttons with a circular arrow icon. The fourth and fifth columns have buttons with a square icon. The sixth and seventh columns have buttons with a circular arrow icon. A red box highlights the 'R', 'G', and 'B' buttons. A red arrow points from a callout box to the 'R' button.

Click to save the new assignment

Change the real color of this line

Shenzhen ZKT Technology Co., Ltd.
 1/F, No. 101, Building B, No. 6, Tangwei Community Industrial Avenue,
 Fuhai Street, Bao'an District, Shenzhen, China



Certificate of Compliance

Certificate Number: ZKT-25070715599C-R1

Certificate's Holder : Natulighting(shenzhen) TechnologyCo.,LTD
 2nd Floor, Building A9, Xinghua Xiong Industrial Park,
 Baihuadong, Guangming District, Shenzhen

Manufacturer : Natulighting(shenzhen) TechnologyCo.,LTD
 2nd Floor, Building A9, Xinghua Xiong Industrial Park,
 Baihuadong, Guangming District, Shenzhen

Trade Mark : N/A

Product : Colorful Light strip

Model(s) : 5V-60-RGB
 5V-30-RGB

REQUIREMENT	STANDARD	Report No.
Art.3.1(a) Safety	EN IEC 62368-1:2024+A11:2024	ZKT-25070715600S-R1
Art.3.1(a) Health	EN IEC 62311:2020 EN 50665:2017	ZKT-25070715599E-1-R1
Art.3.1(b) EMC	ETSI EN 301 489-1 V2.2.3 (2019-11) ETSI EN 301 489-17 V3.3.1 (2024-09) ETSI EN 301 489-3 V2.3.2 (2023-01)	ZKT-25070715599E-2-R1
Art.3.2 Radio	ETSI EN 300 328 V2.2.2 (2019-07)	ZKT-25070715599E-3-R1
	ETSI EN 300 440 V2.2.1 (2018-07)	ZKT-25070715599E-4-R1

This Attestation of Compliance is issued on a voluntary basis for electrical equipment below the voltage limits of Radio Equipment Directive (RED) 2014/53/EU. The essential requirement are fulfilled accordingly based on the technical specifications applicable at the time of issuance.



This Certificate of Conformity is based on single evaluation of the submitted sample(s) of the above mentioned product. It does not imply an assessment of the whole product and relevant Directives to be observed.

Shenzhen ZKT Technology Co., Ltd.

1/F, No. 101, Building B, No. 6, Tangwei Community Industrial Avenue,
Fuhai Street, Bao'an District, Shenzhen, China



Certificate of Compliance

Certificate Number: ZKT-24122719691C

Certificate's Holder	: Natu lighting (Shenzhen)Technology Co.,LTD. Floor 4, Building 3, Zone E, Xinyongfeng Industrial Park, Shilong Avenue, Shiyan Shuitian Scommunity, Baoan District, Shenzhen
Manufacturer	: Natu lighting (Shenzhen)Technology Co.,LTD. Floor 4, Building 3, Zone E, Xinyongfeng Industrial Park, Shilong Avenue, Shiyan Shuitian Scommunity, Baoan District, Shenzhen
Trade Mark	: NT
Product	: Colorful light strip
Model(s)	: 5V-60-RGB 5V-30-RGB
Test Method	: IEC 62321-3-1:2013, IEC 62321-4:2013+A1:2017, IEC 62321-5:2013, IEC 62321-6:2015, IEC 62321-7-1:2015, IEC 62321-7-2:2017, IEC 62321-8:2017

The following products have been tested by us and found in conformity with the (RoHS) Directive 2011/65/EU Annex II amending Annex (EU)2015/863 and amending Annex (EU)2017/2102. It is possible to use CE Marking to demonstrate the conformity with this Directive.It is only valid in connection with the test report number: ZKT-24122719691R.

RoHS



This Certificate of Conformity is based on single evaluation of the submitted sample(s) of the above mentioned product. It does not imply an assessment of the whole product and relevant . Directives to be observed.