

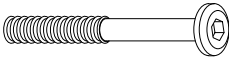





A		4*30	60
B		M6*40	18
C			2
D		Φ8*30	20
E		M6*140	4
F		M6*60	6
G		M6*60	24
H			2



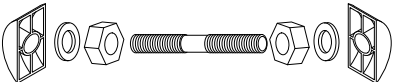
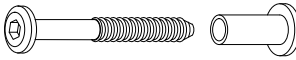
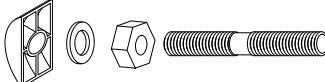

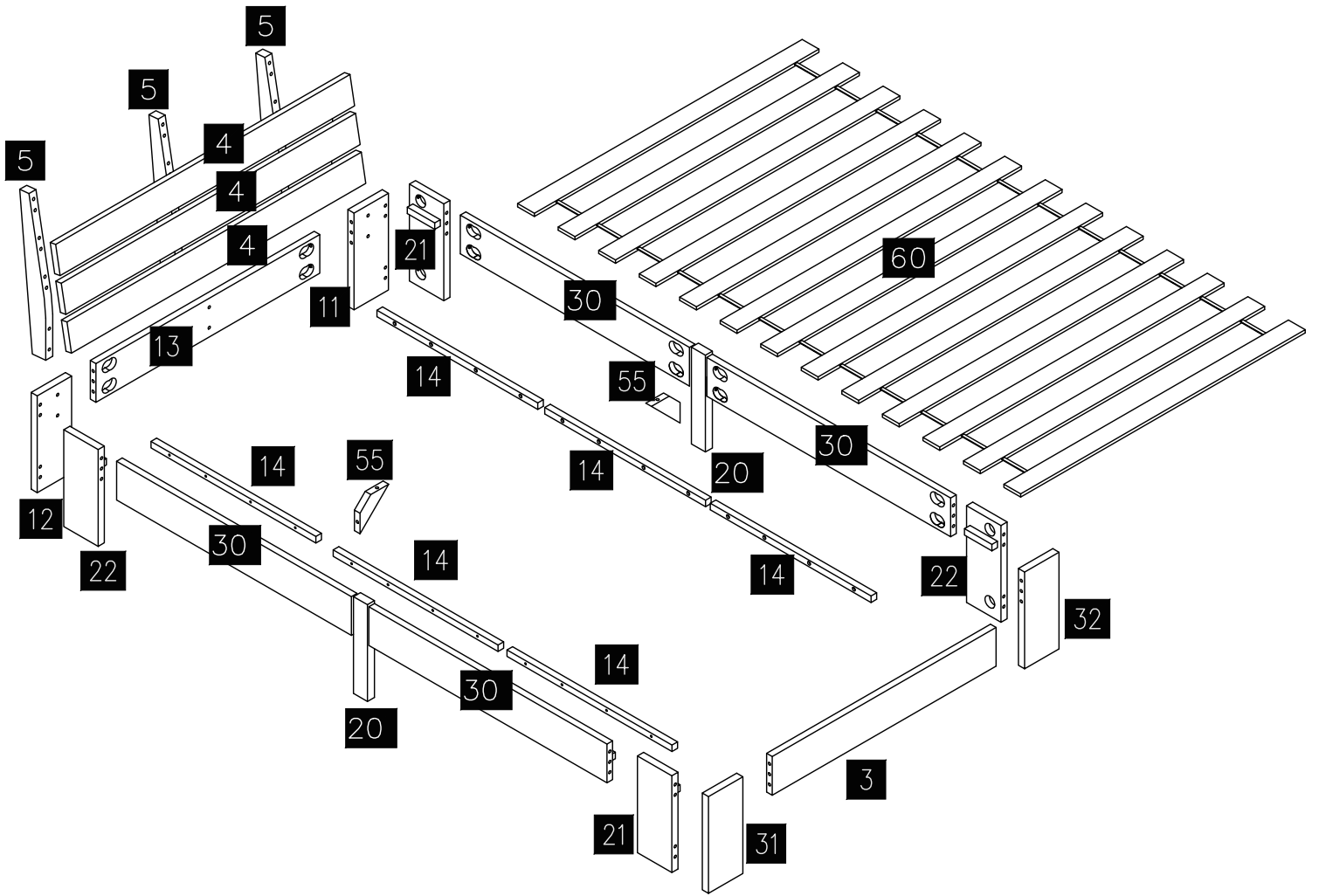
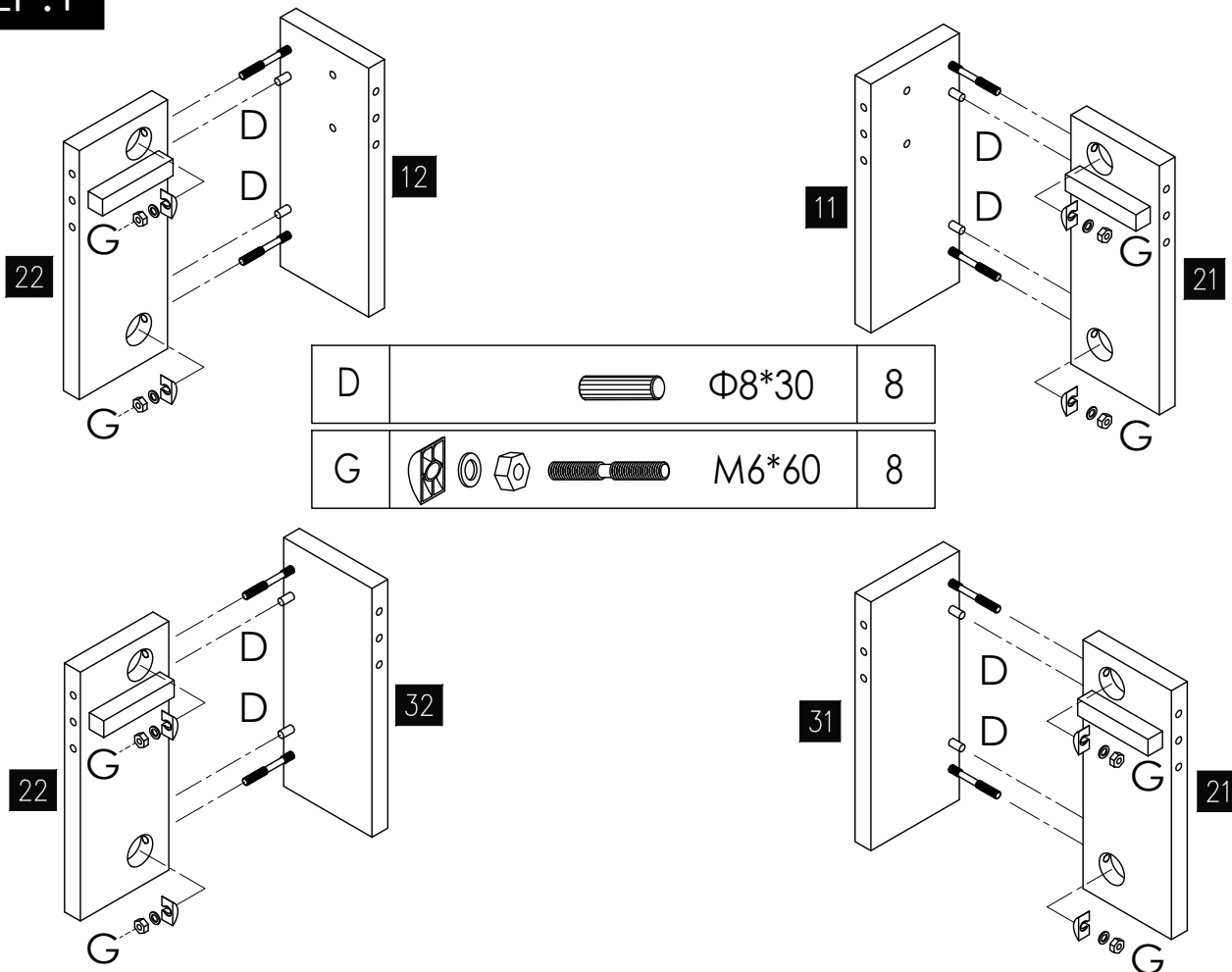
STEP:1



D		$\Phi 8*30$	8
G		M6*60	8

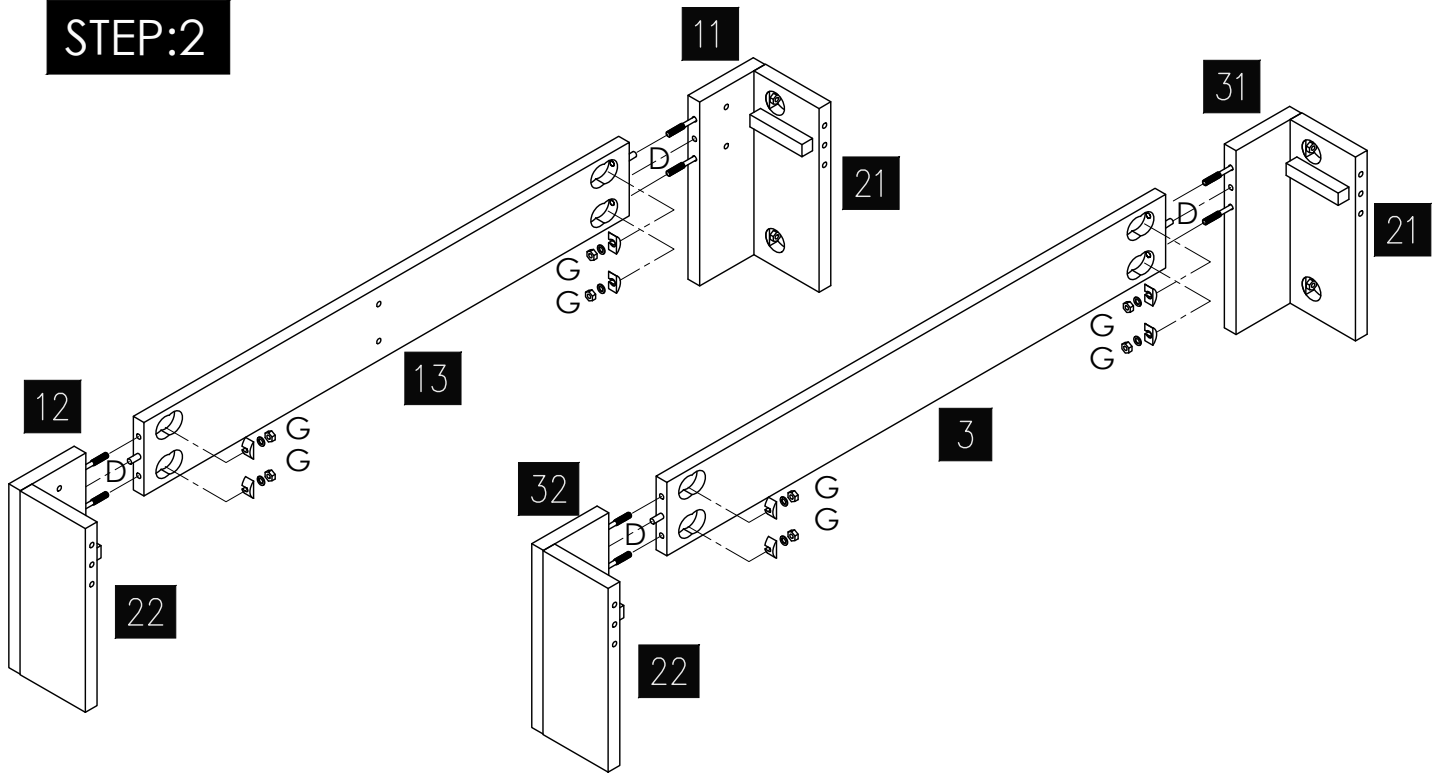

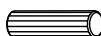
STEP:2

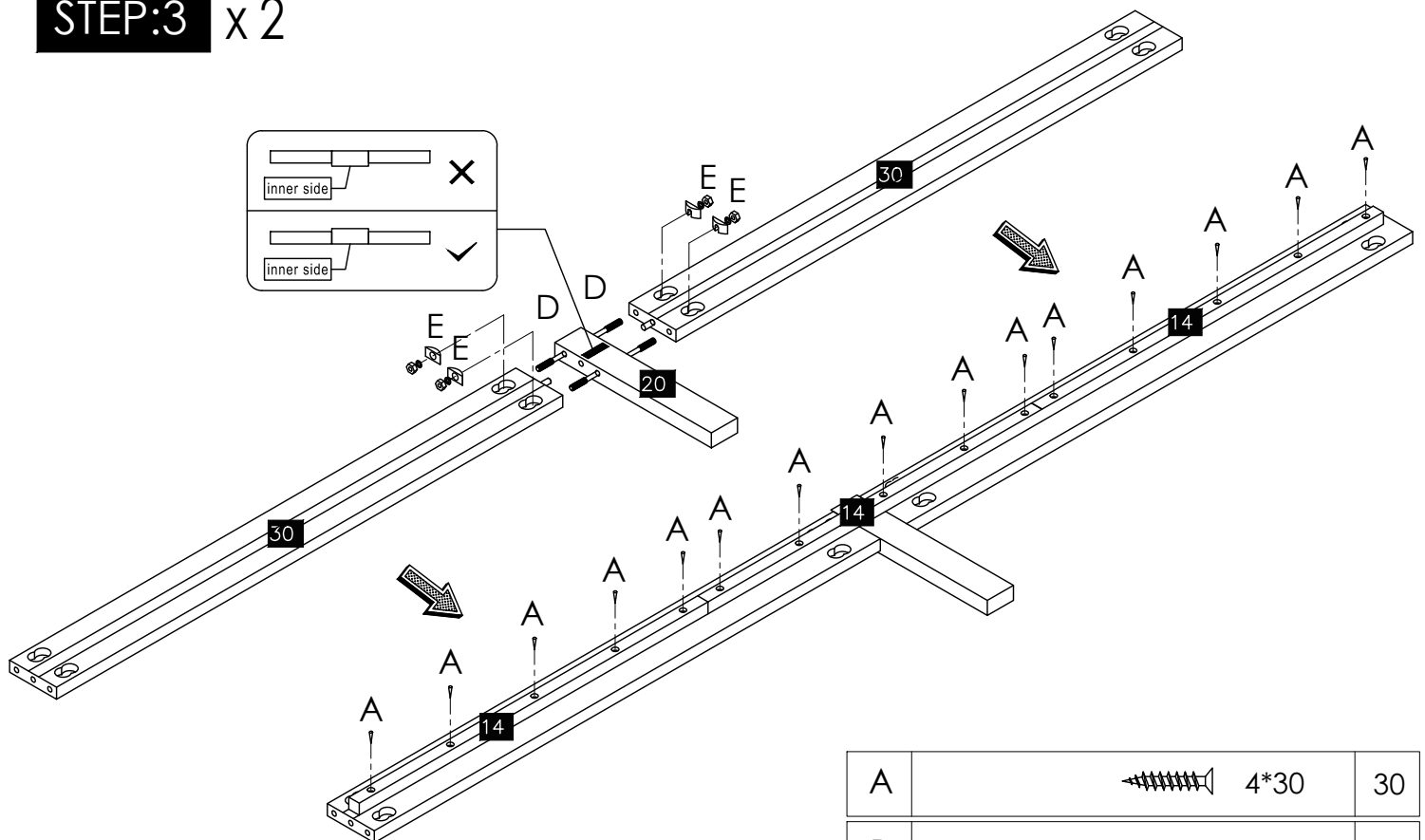

D		Φ8*30	4
G		M6*60	8

STEP:3 x 2



A		4*30	30
D		Φ8*30	4
E		M6*140	4

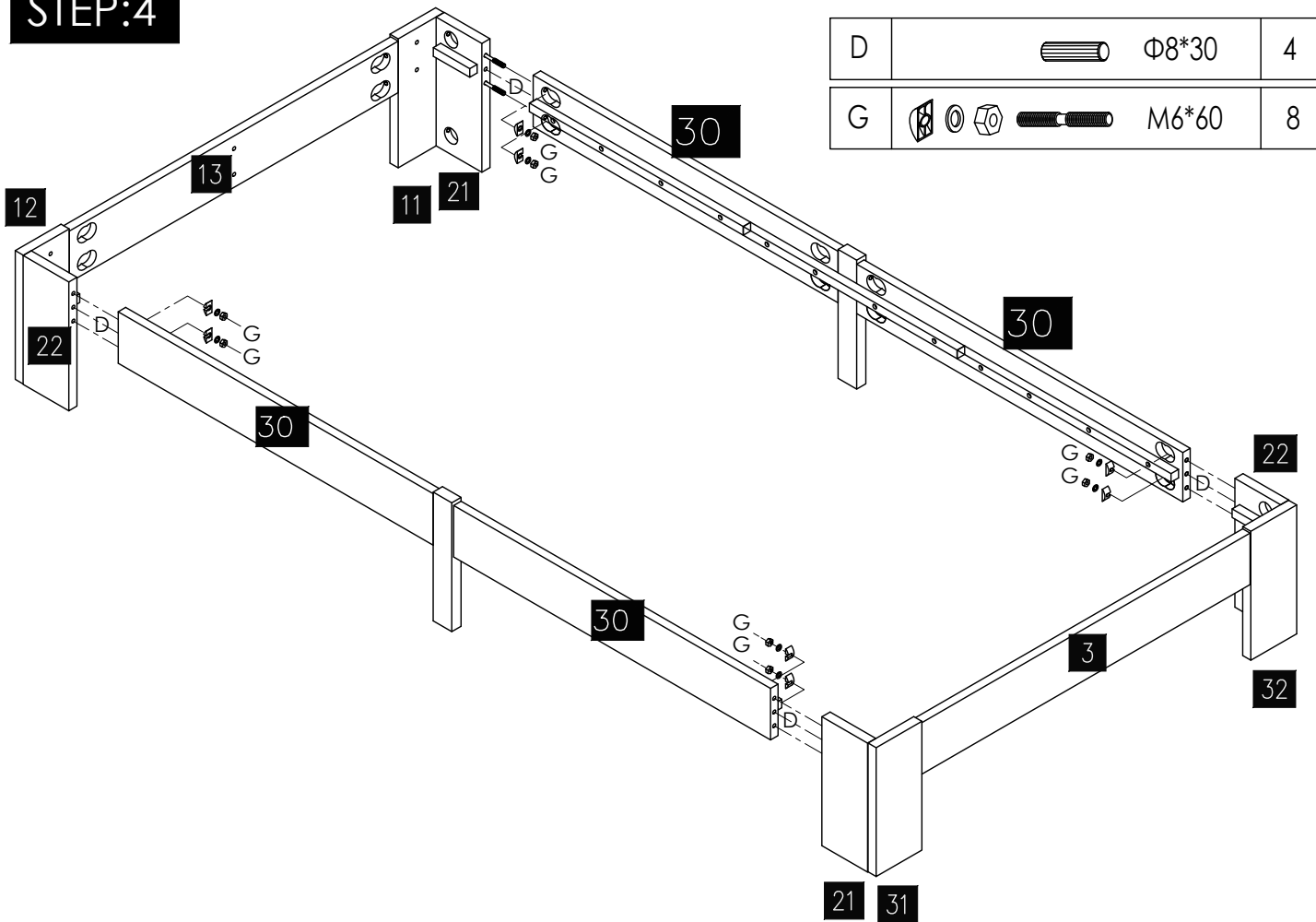

STEP:4

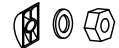

D		Φ8*30	4
G		M6*60	8

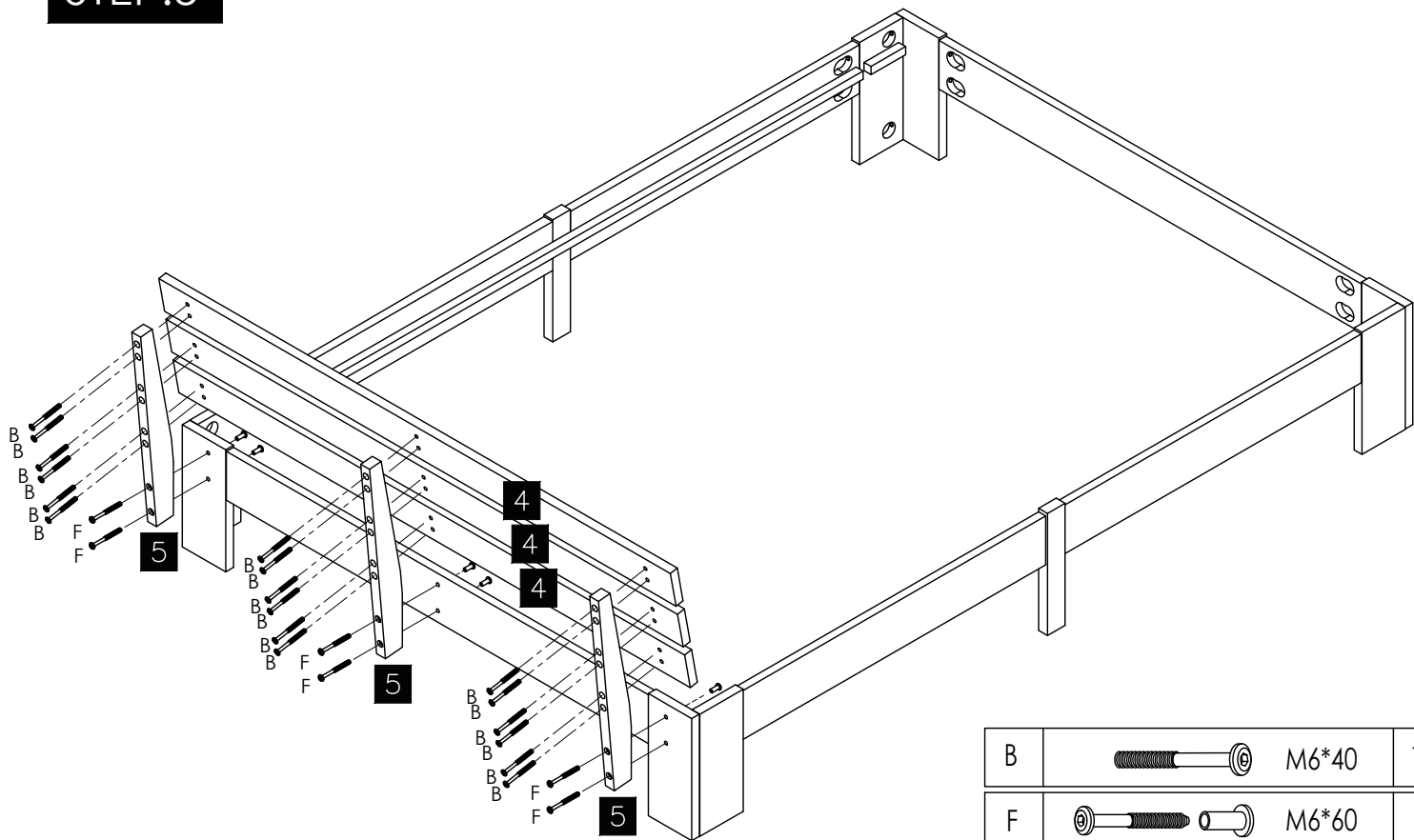
STEP:5



B		M6*40	18
F		M6*60	6

STEP:6

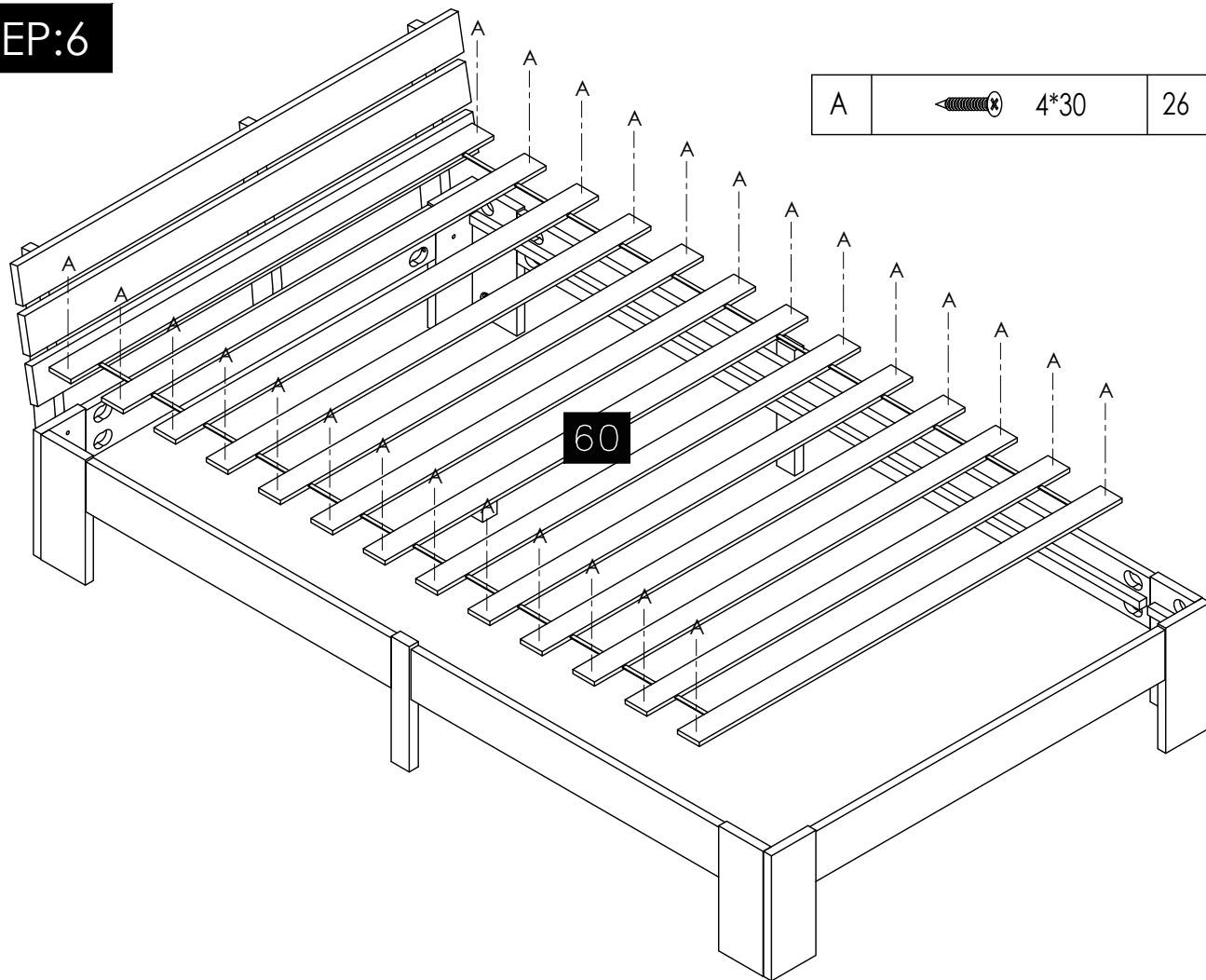

STEP:7

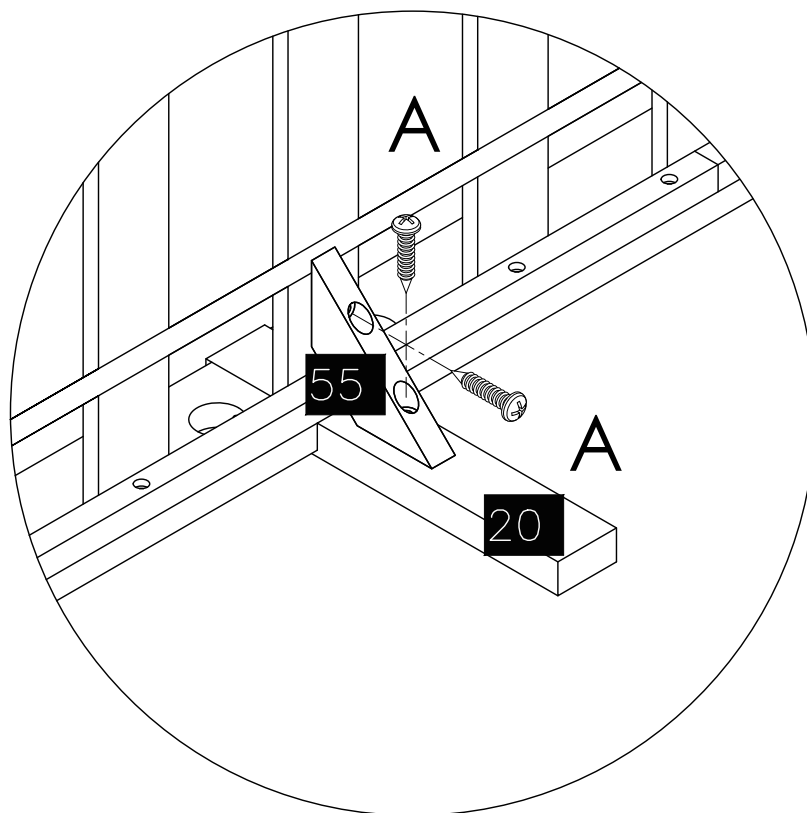

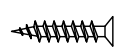
A		4*30	4
---	---	------	---