

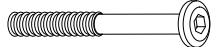



| | | | |
|---|---|--------|----|
| A |  | 4*30 | 96 |
| B |  | M6*40 | 24 |
| C |  | | 2 |
| D |  | Φ8*30 | 22 |
| E |  | M6*140 | 6 |
| F |  | M6*60 | 8 |
| G |  | M6*60 | 24 |
| H |  | Φ7*60 | 4 |
| I |  | | 2 |



STEP:1

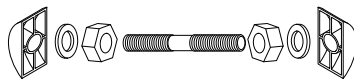
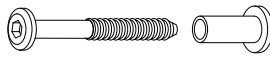
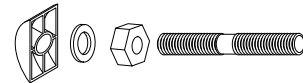

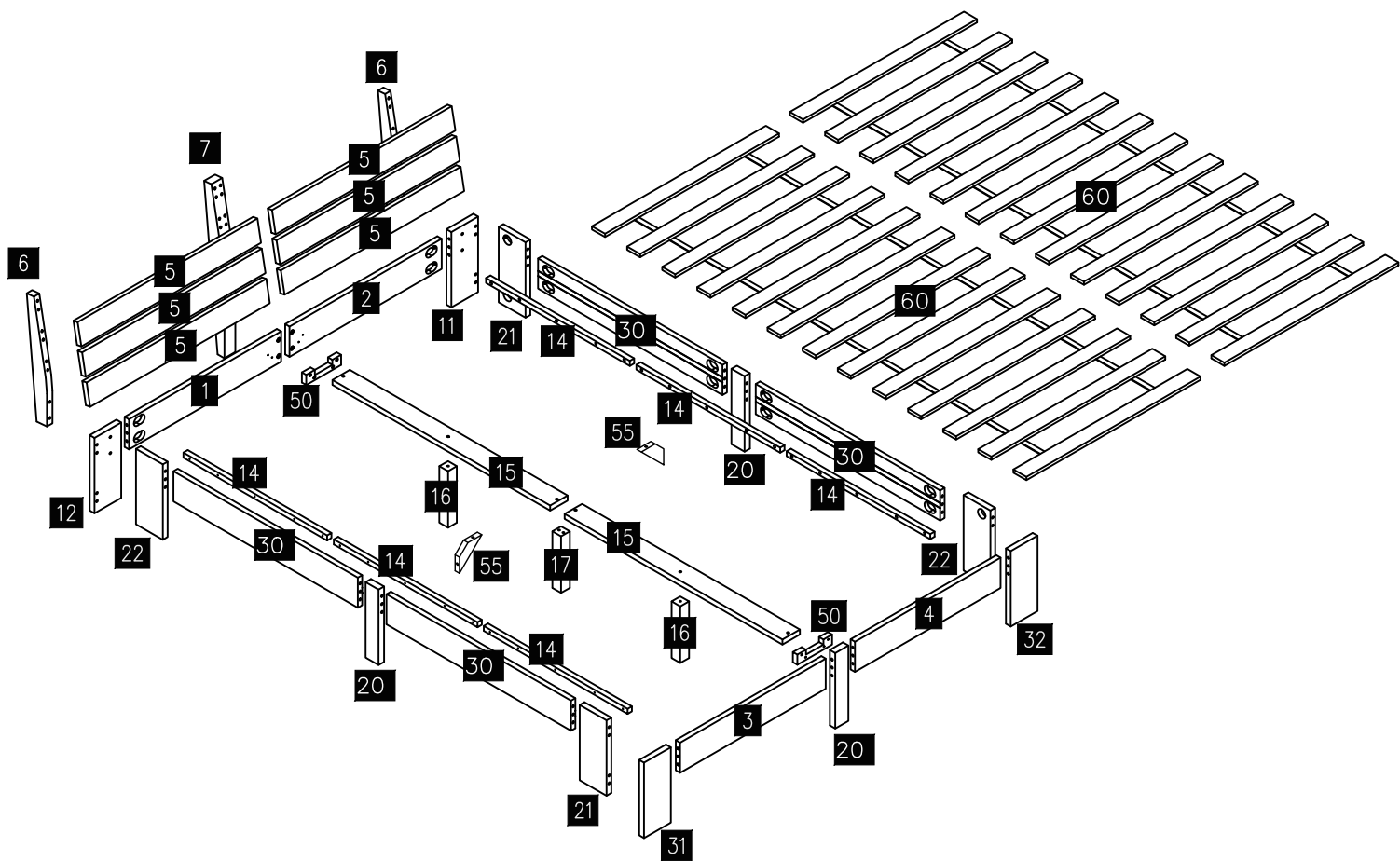
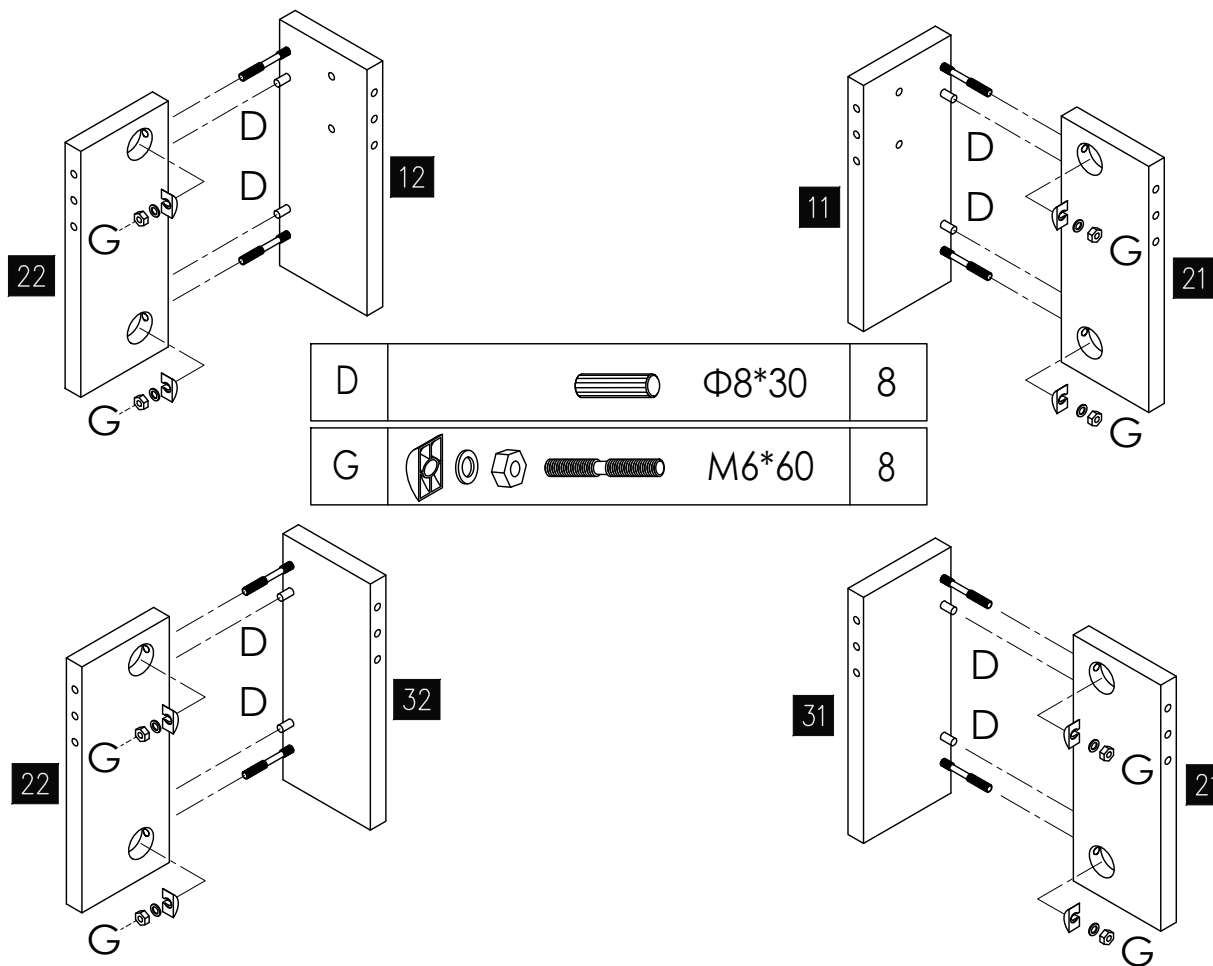
STEP:2

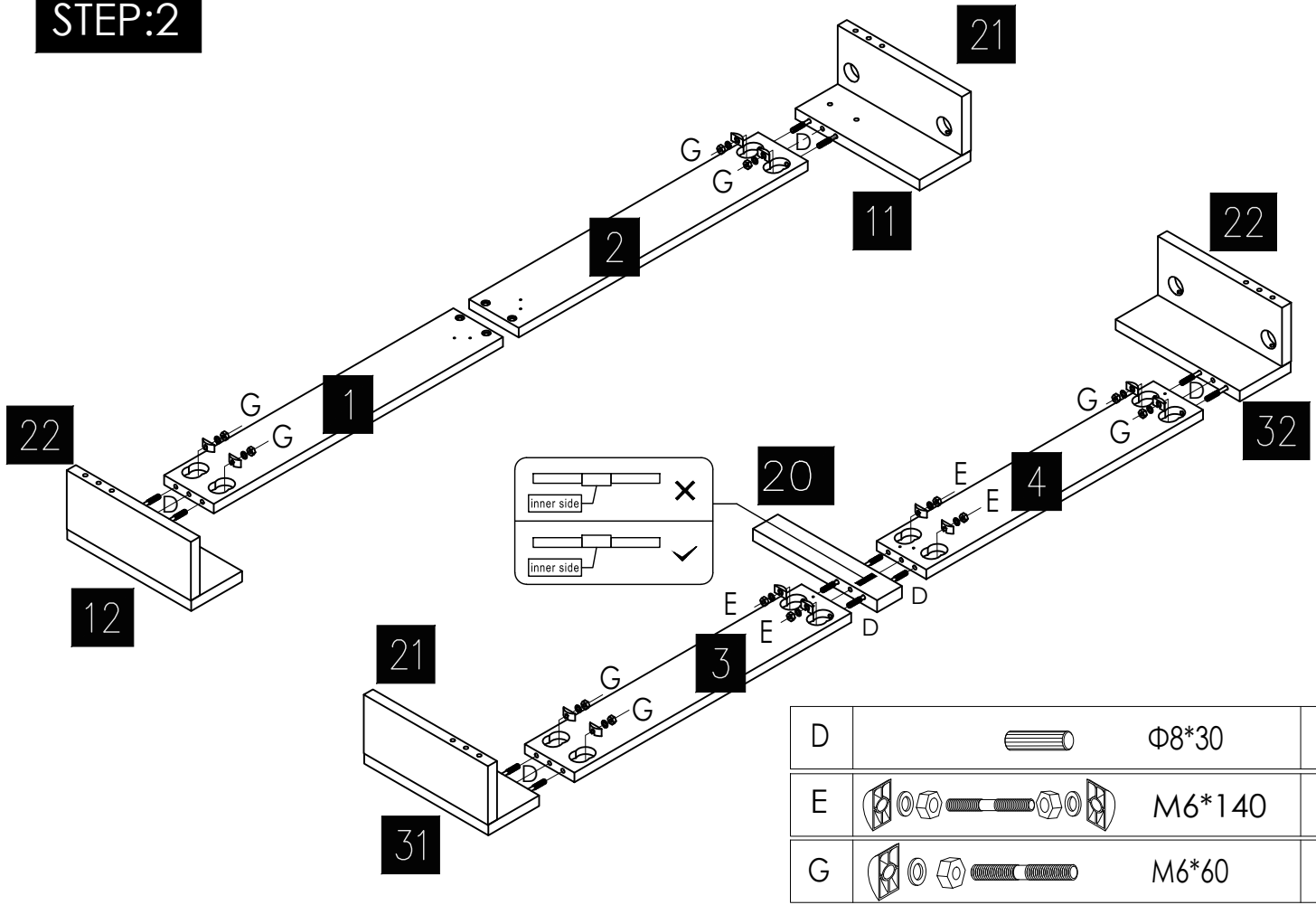

| | | | |
|---|--|--------|---|
| D | | Φ8*30 | 6 |
| E | | M6*140 | 2 |
| G | | M6*60 | 8 |

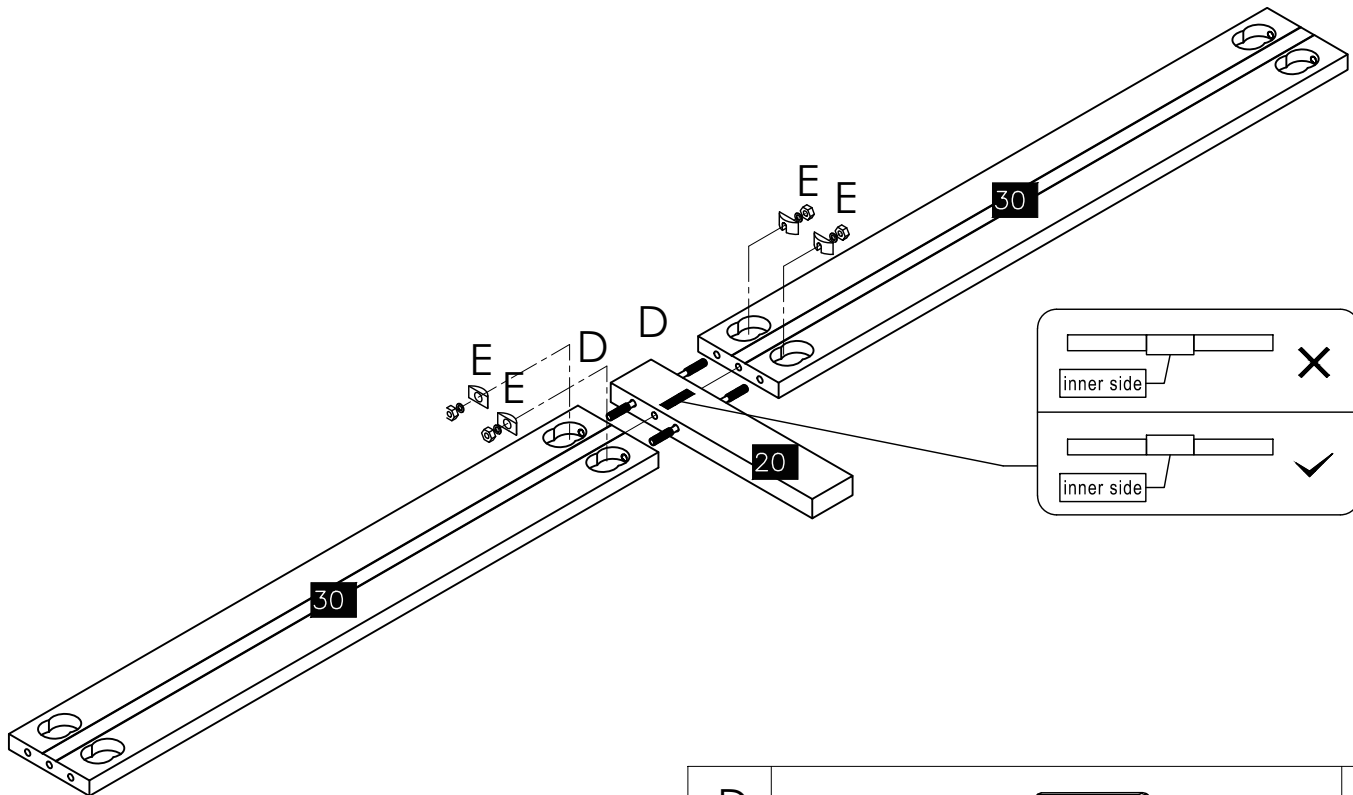

STEP:3 x 2



| | | | |
|---|--|--------|---|
| D | | Φ8*30 | 4 |
| E | | M6*140 | 4 |

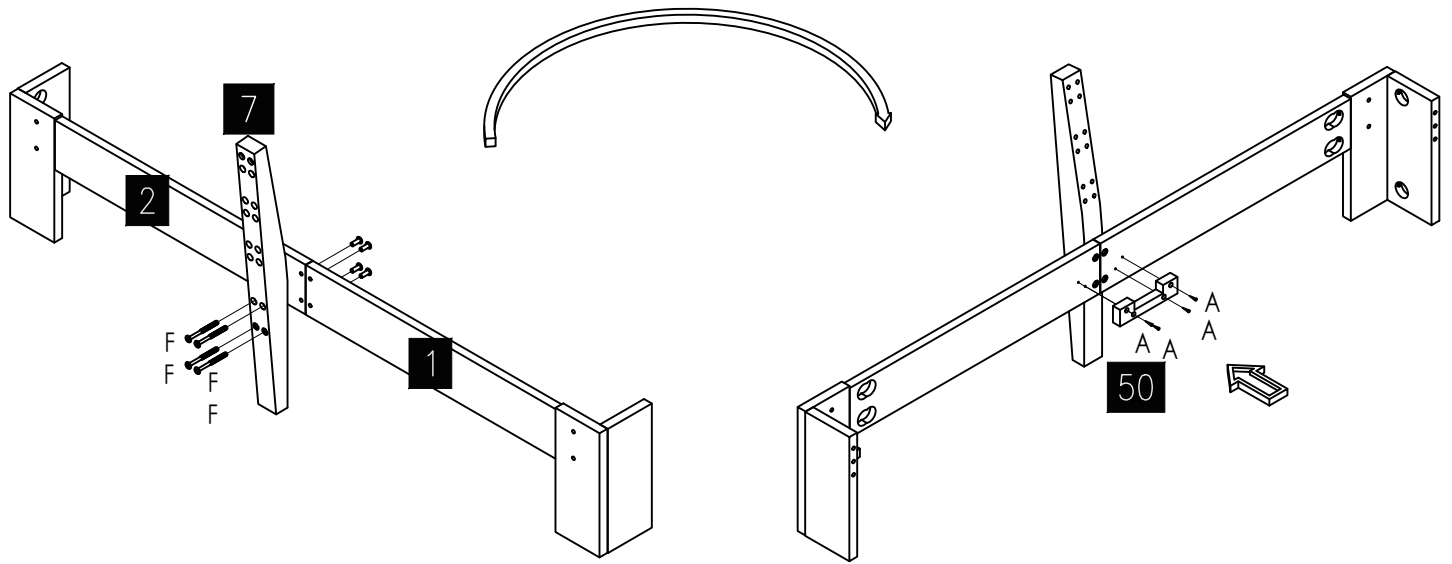

STEP:4



| | | | |
|---|---|-------|---|
| A |  | 4*30 | 4 |
| F |  | M6*60 | 4 |

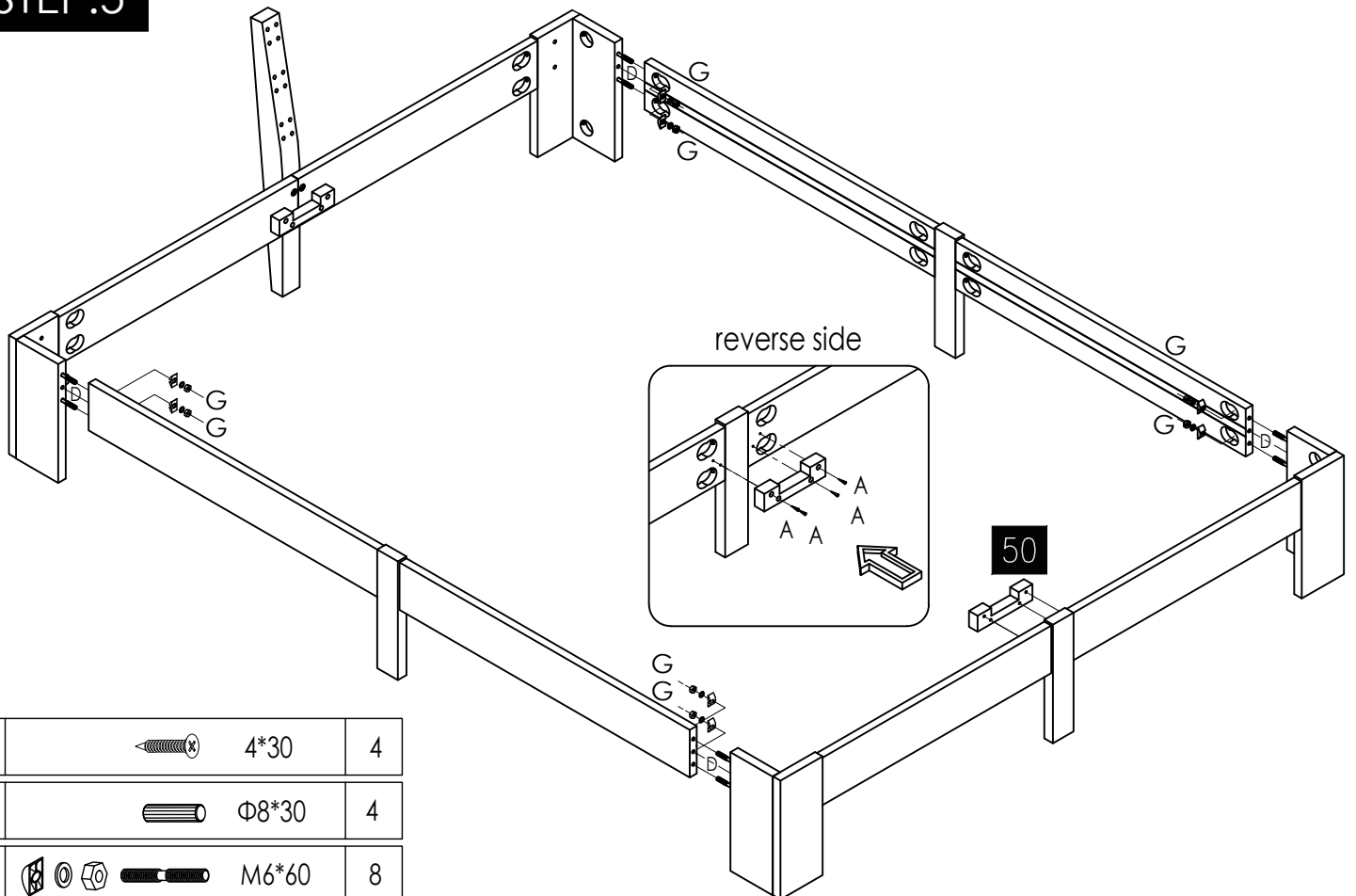

STEP:5



| | | | |
|---|---|-------|---|
| A |  | 4*30 | 4 |
| D |  | Φ8*30 | 4 |
| G |  | M6*60 | 8 |

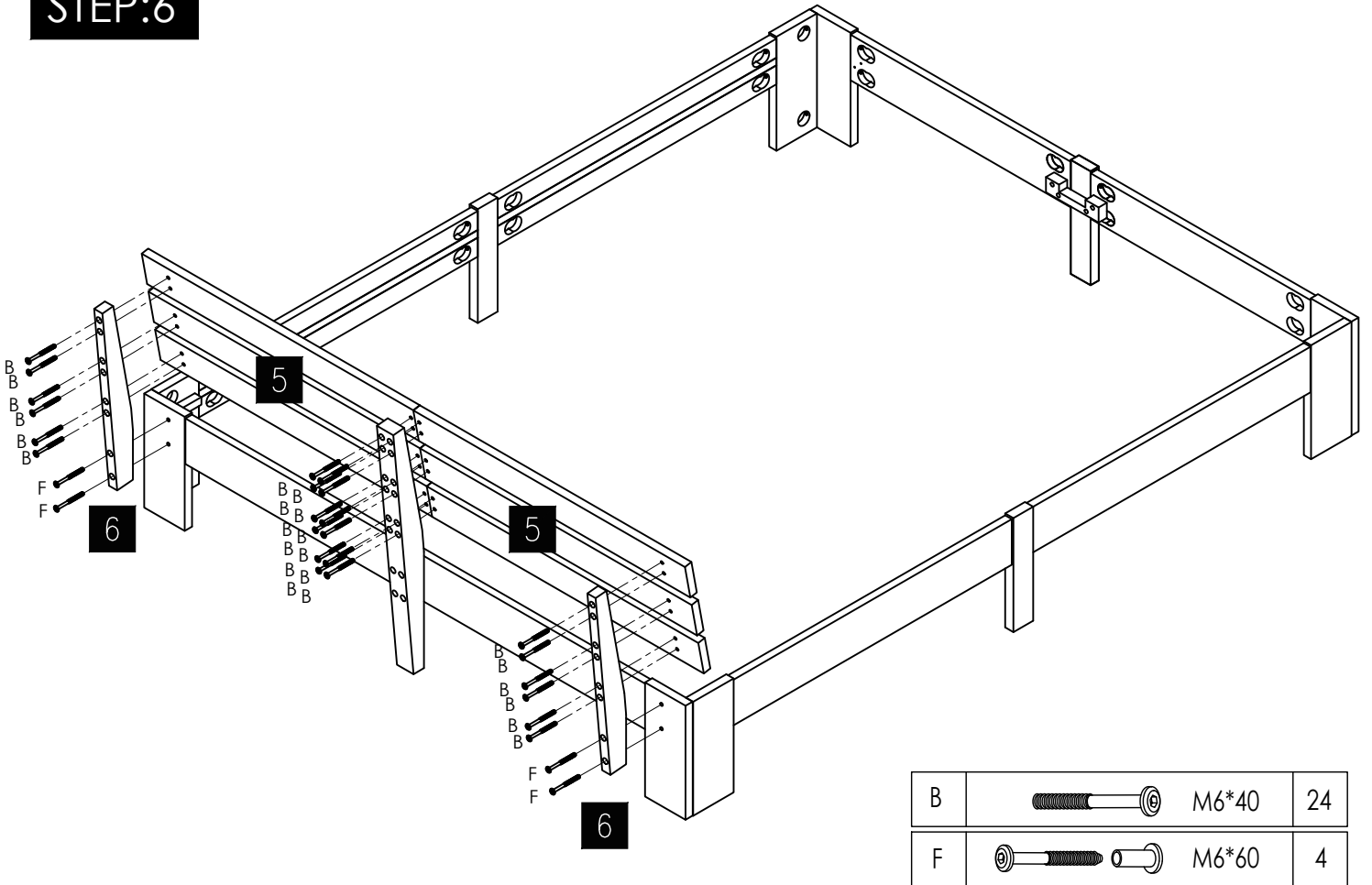

STEP:6

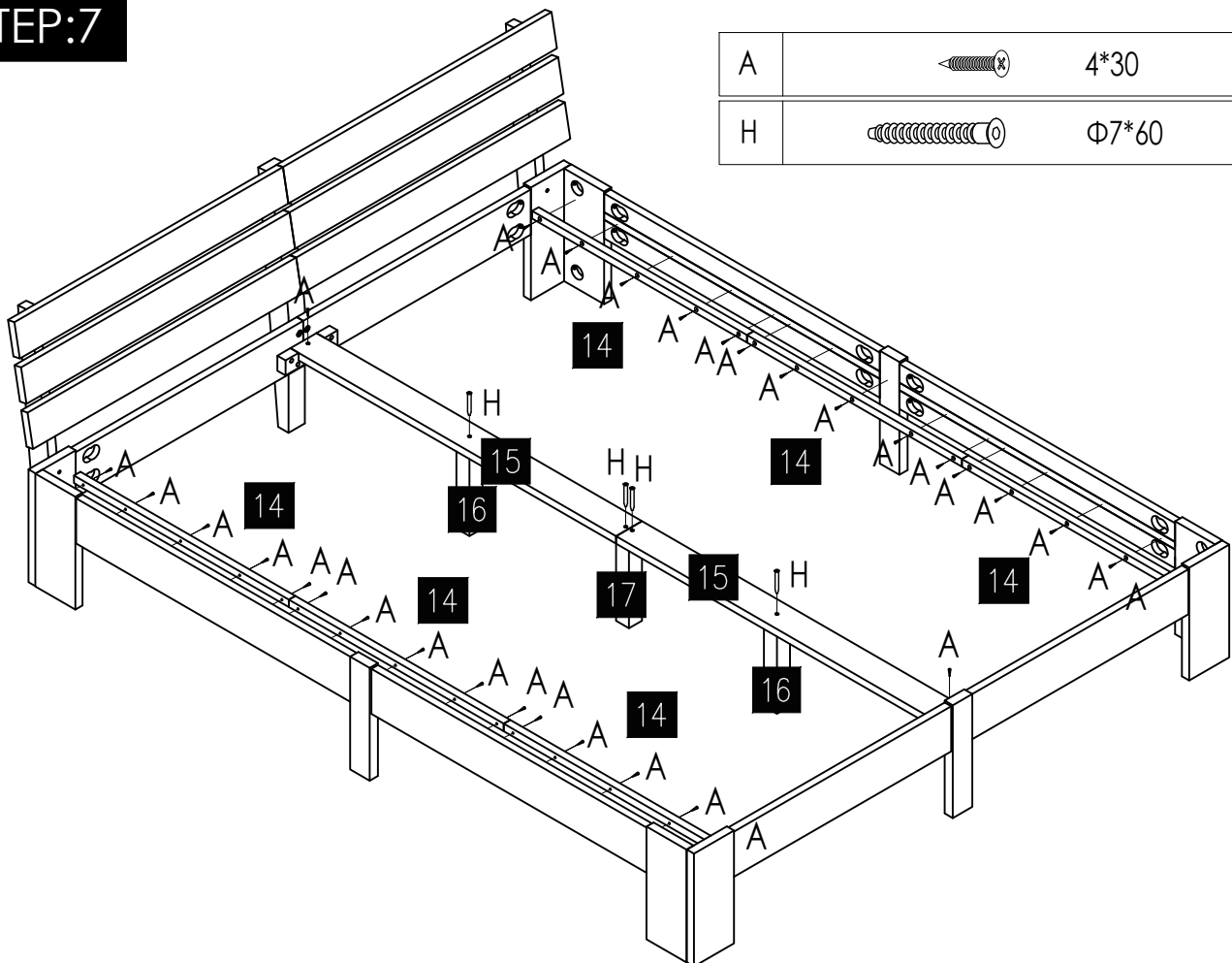

| | | | |
|---|---|-------|----|
| B |  | M6*40 | 24 |
| F |  | M6*60 | 4 |

STEP:7



| | | | |
|---|---|-------|----|
| A |  | 4*30 | 32 |
| H |  | Φ7*60 | 4 |

STEP:6

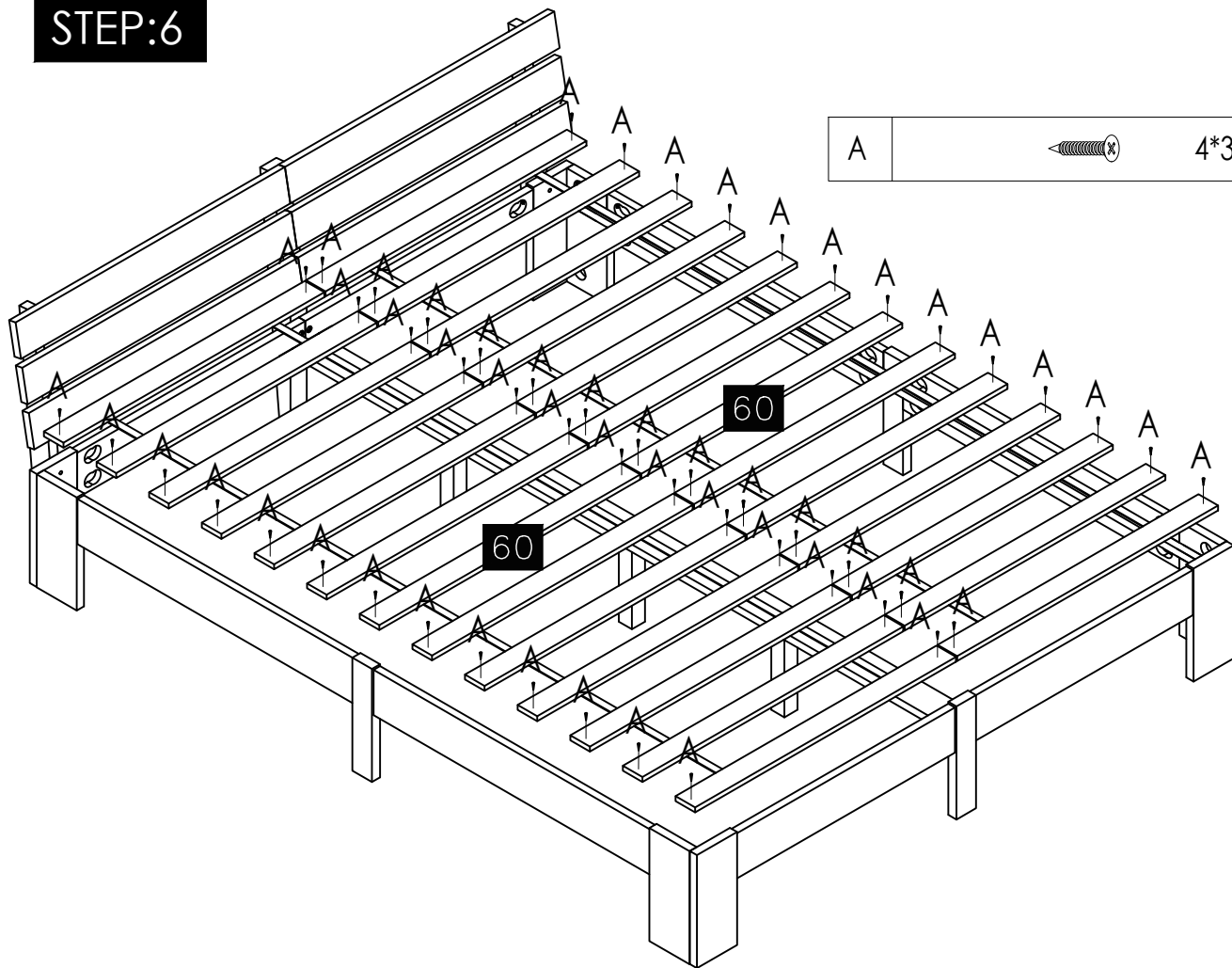

| | | | |
|---|---|------|----|
| A |  | 4*30 | 52 |
|---|---|------|----|

STEP:7

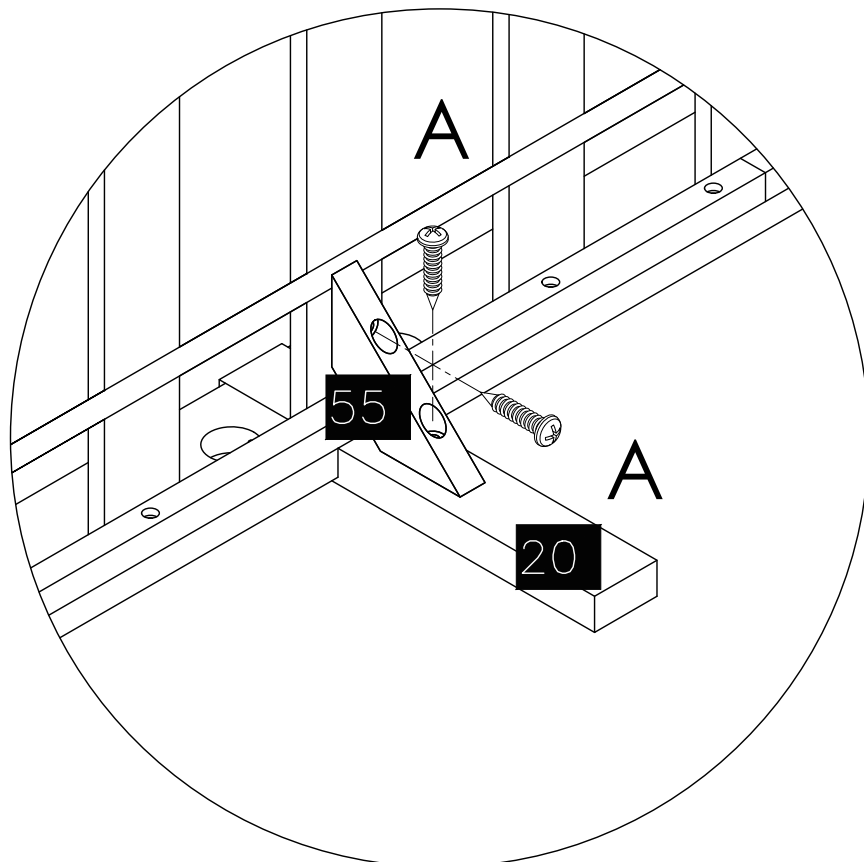

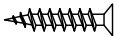
| | | | |
|---|---|------|---|
| A |  | 4*30 | 4 |
|---|---|------|---|