

PULANGI

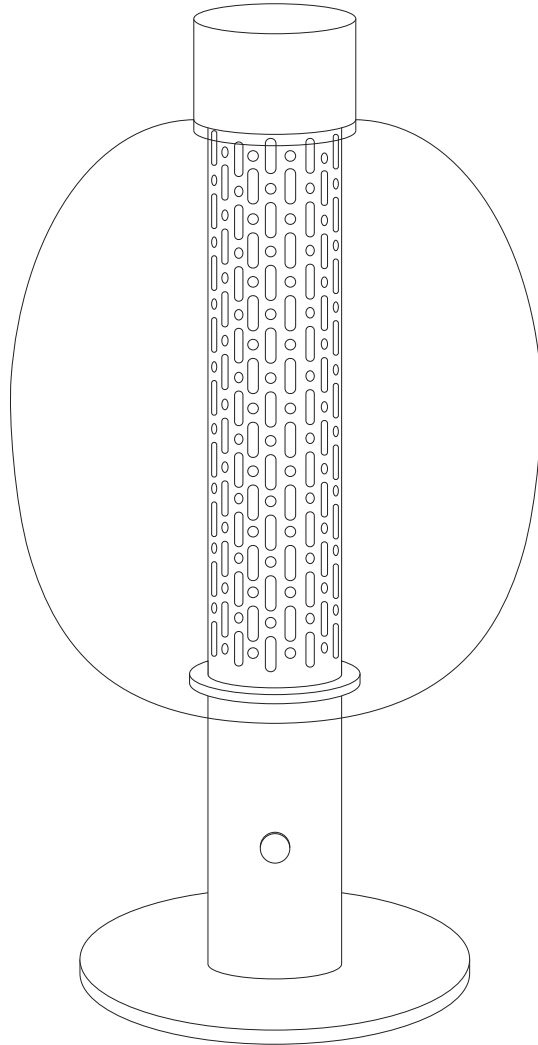

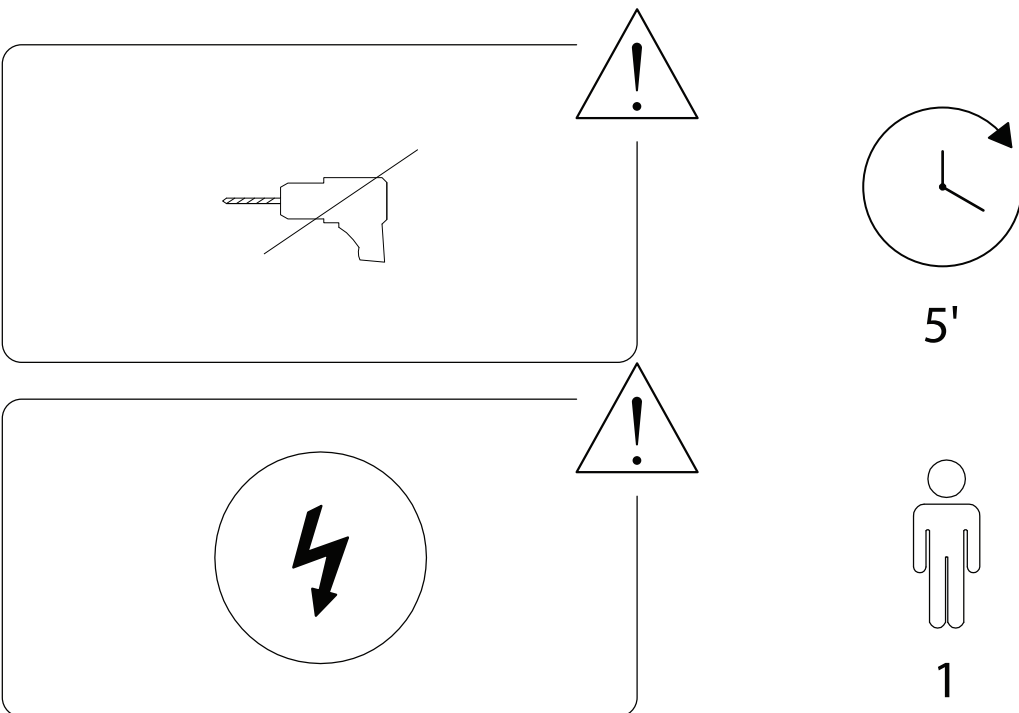

A

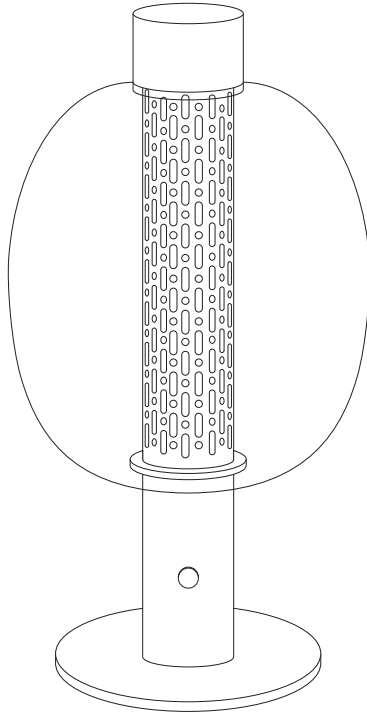
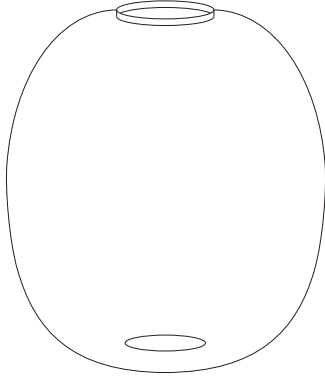

B

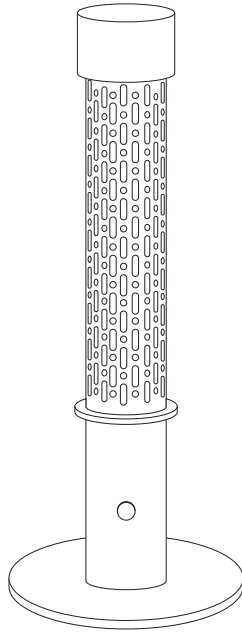

C

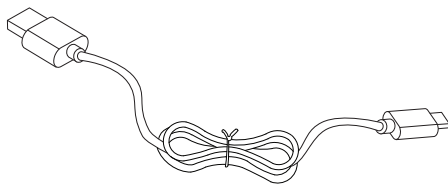

A

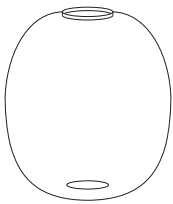

x 1

B

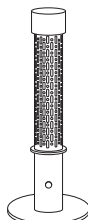

x 1

C

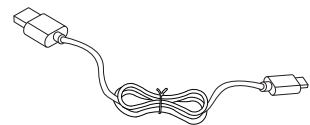

x 1

1

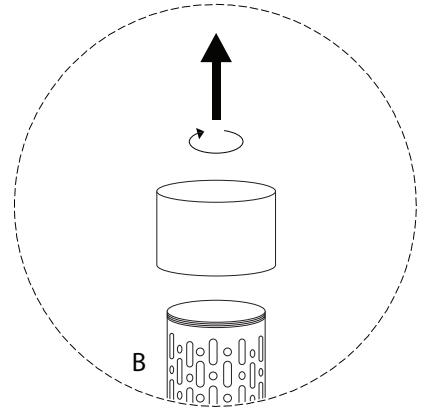
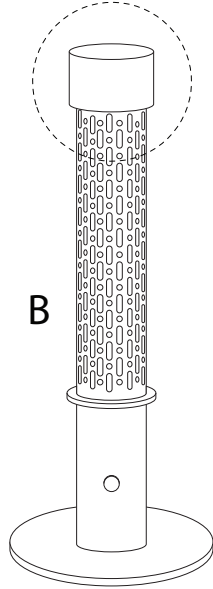

2

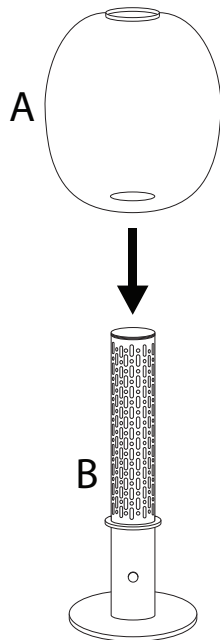
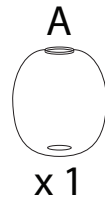

3

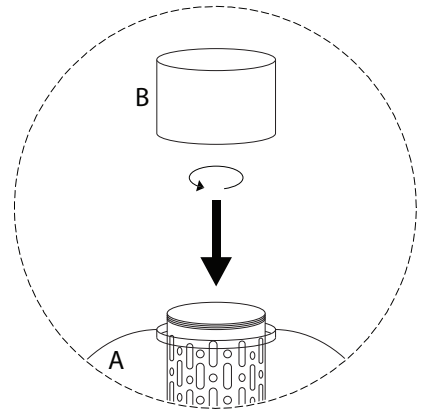
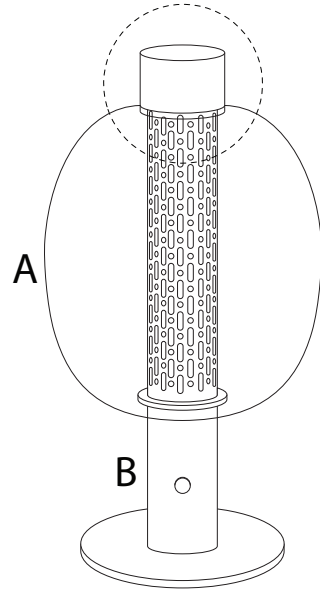

4

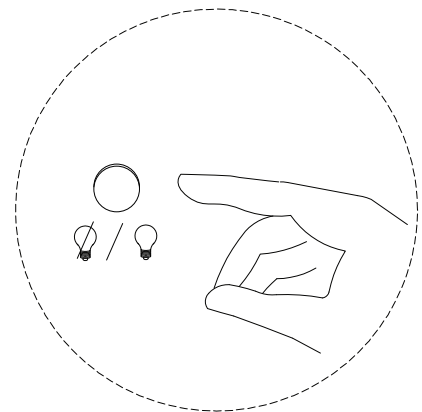
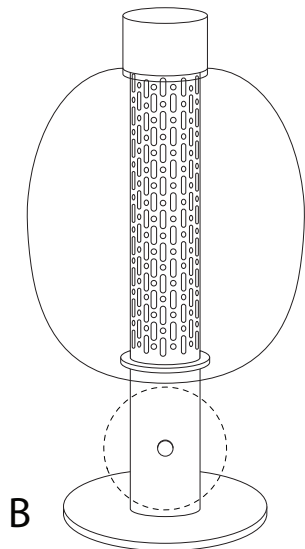

5

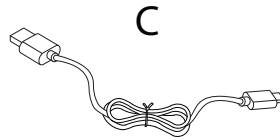

x1

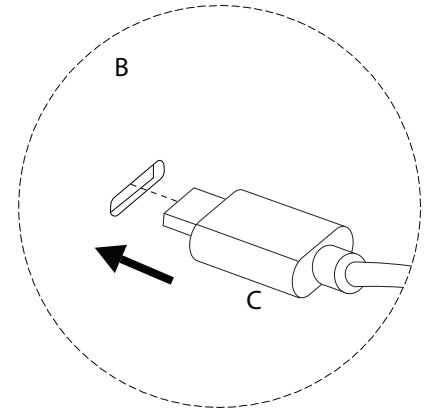
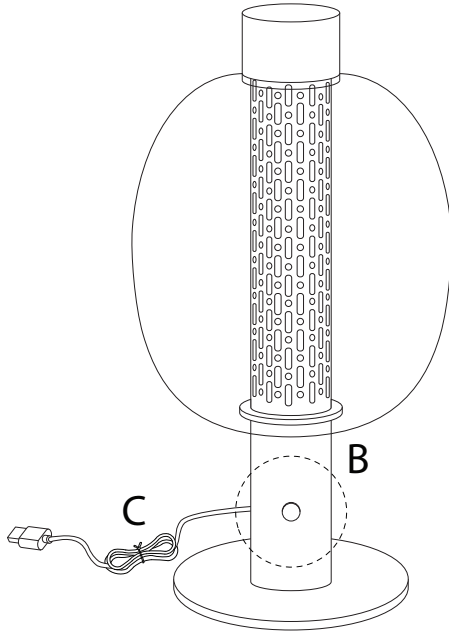

!

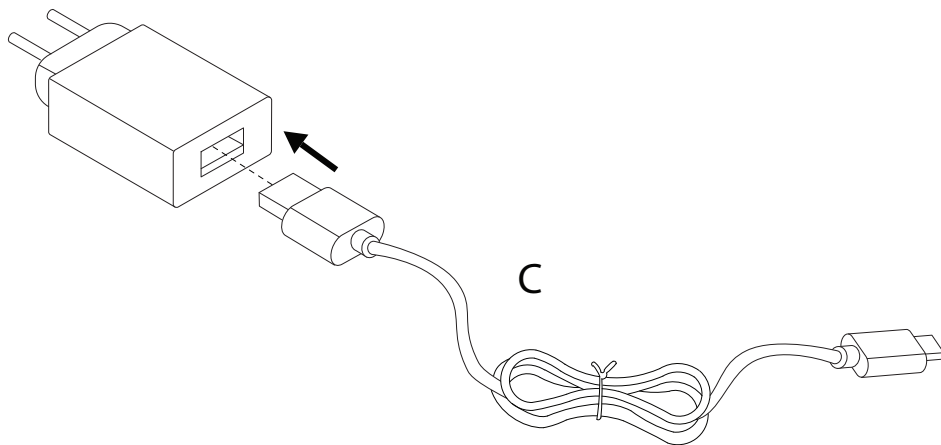

6

