

BLAT 60 CM BL850, 89-60-B  
 BLAT 80 CM BL851, 89-80-B

SILIKON

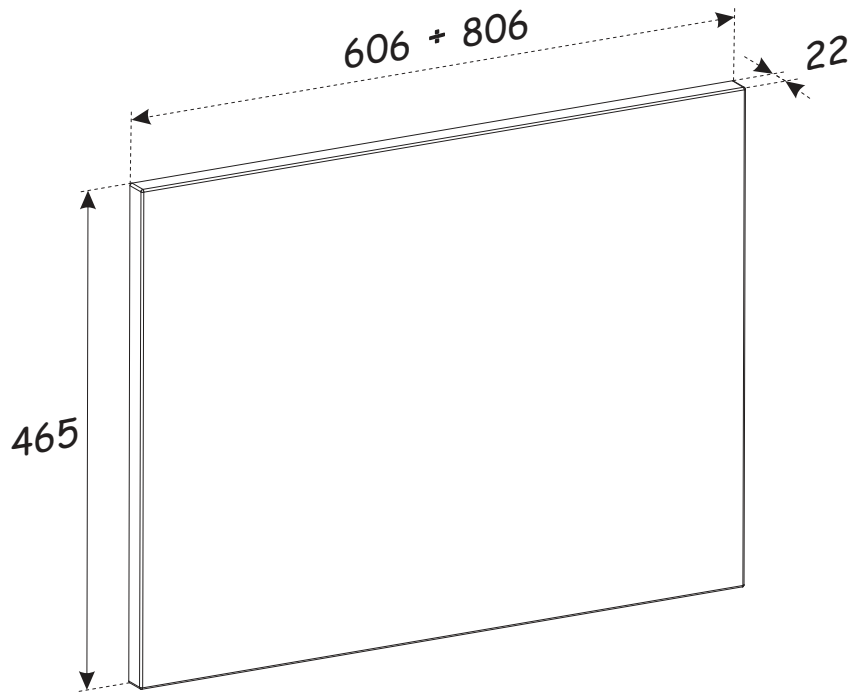

90 min

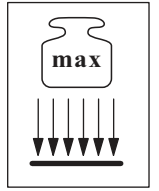
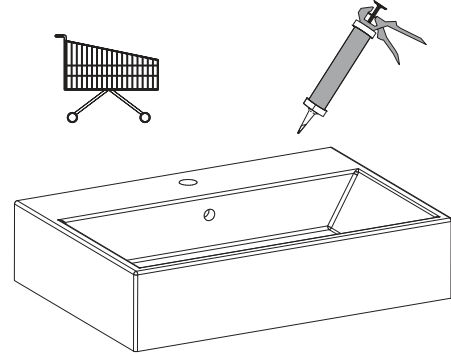
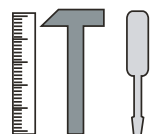
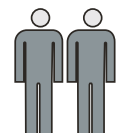

BLAT 60 CM BL850, 89-60-B

NO	Dim.			Col.-No	Qty
1	606	465	22	1	1

BLAT 80 CM BL851, 89-80-B

NO	Dim.			Col.-No	Qty
1	806	465	22	1	1

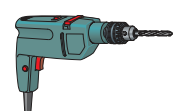

BLAT 60 CM BL850, 89-60-B  
BLAT 80 CM BL851, 89-80-B

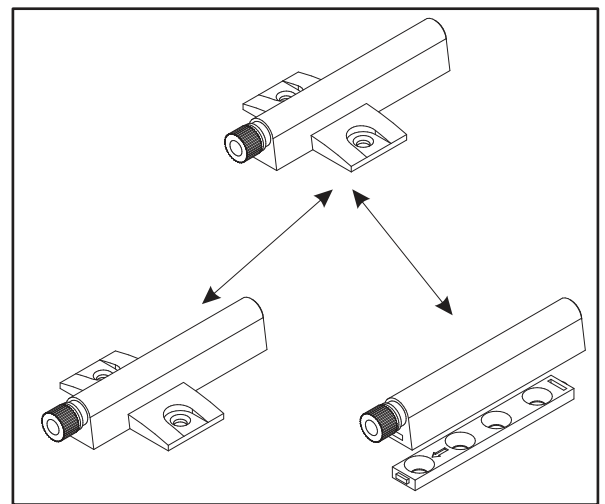
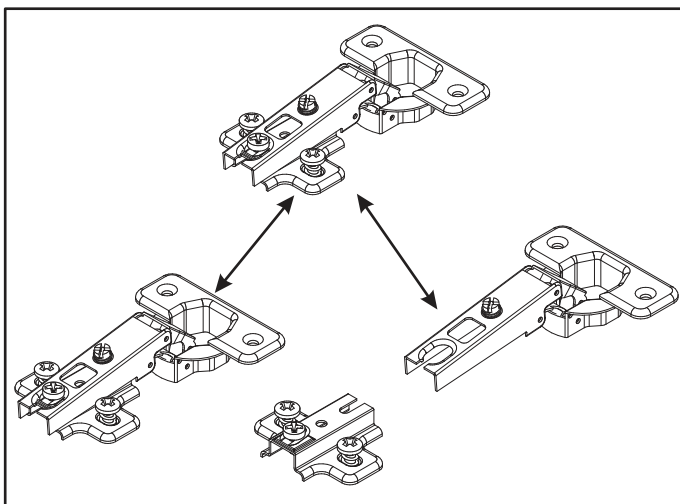
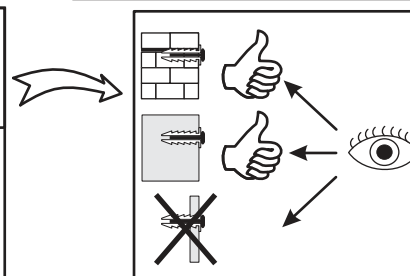
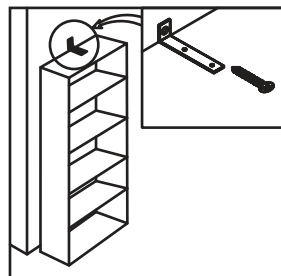
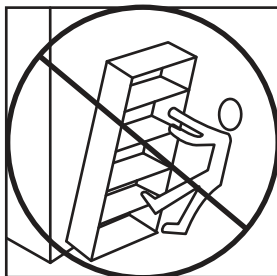
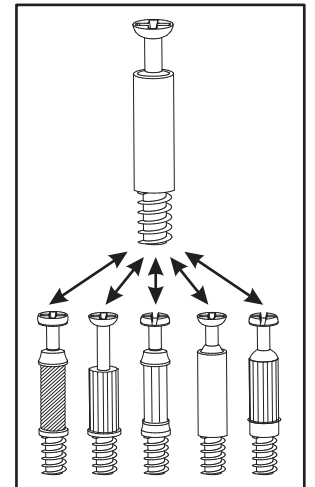
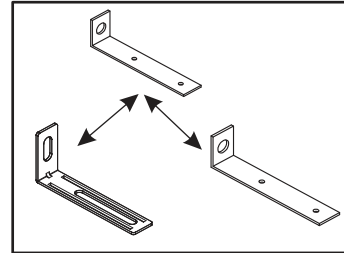
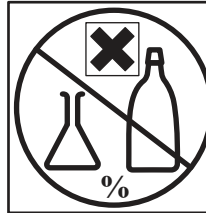
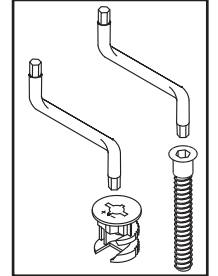
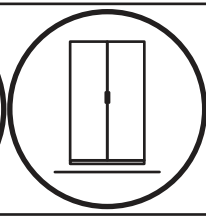
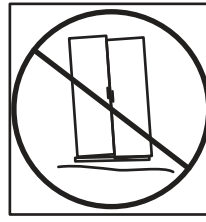
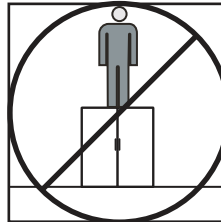
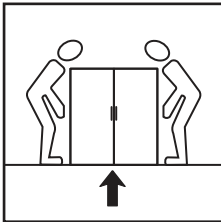
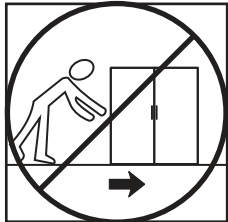
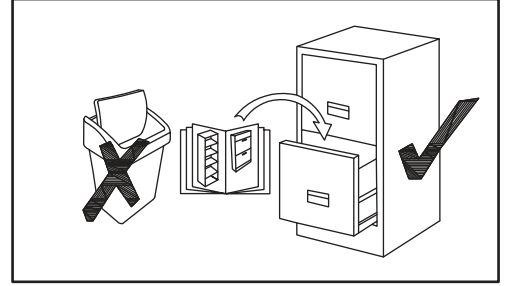
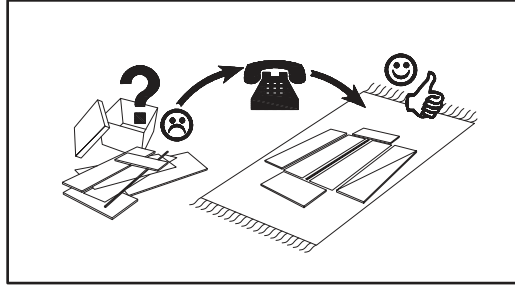
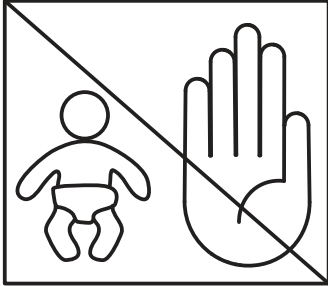
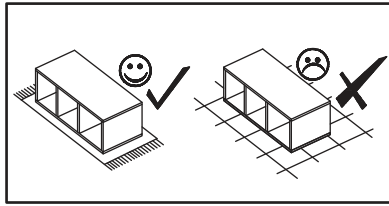
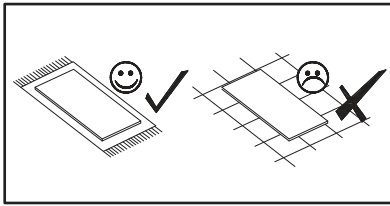

BLAT 60 CM BL850, 89-60-B  
BLAT 80 CM BL851, 89-80-B

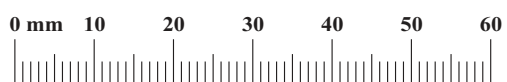
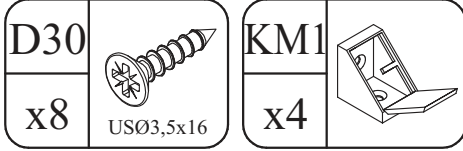

BLAT 60 CM BL850, 89-60-B  
BLAT 80 CM BL851, 89-80-B

# SZAFKA P./UM 2SZ 82-60-B-2S ; SZAFKA P./UM 2SZ 82-80-B-2S

## 1

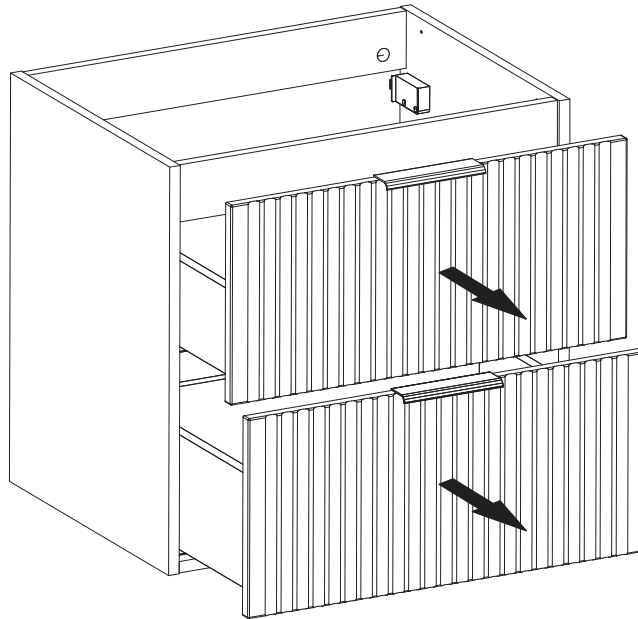
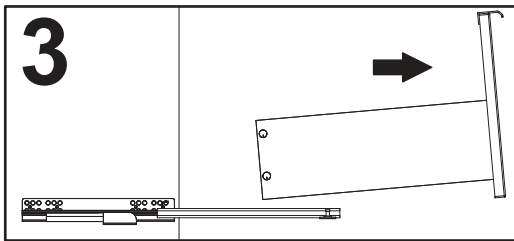
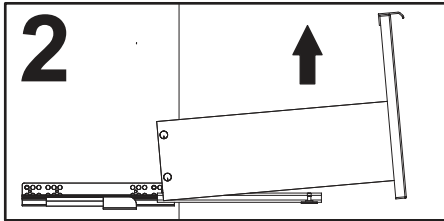
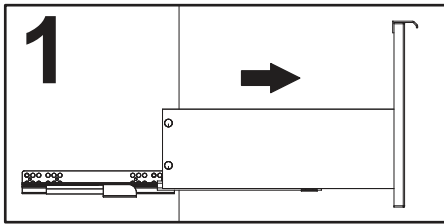

## 2

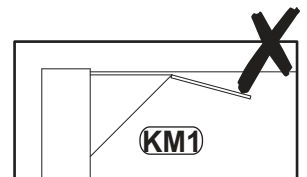
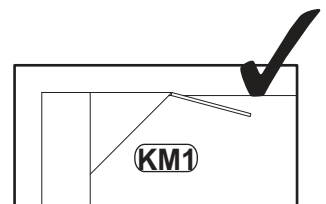
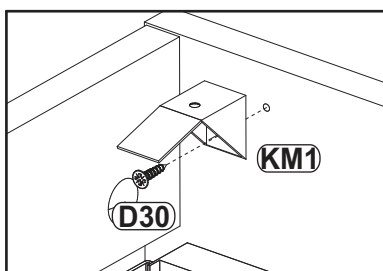
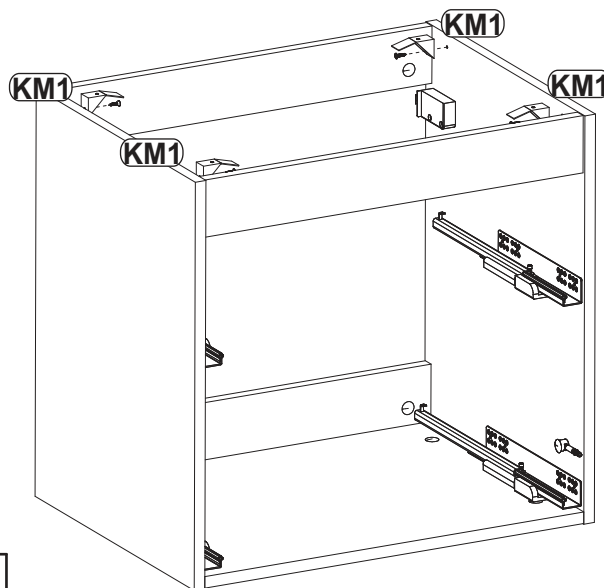
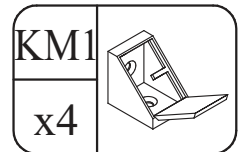
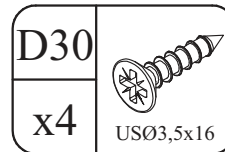

BLAT 60 CM BL850, 89-60-B  
BLAT 80 CM BL851, 89-80-B

3

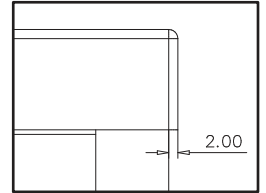
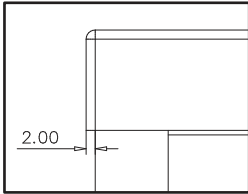
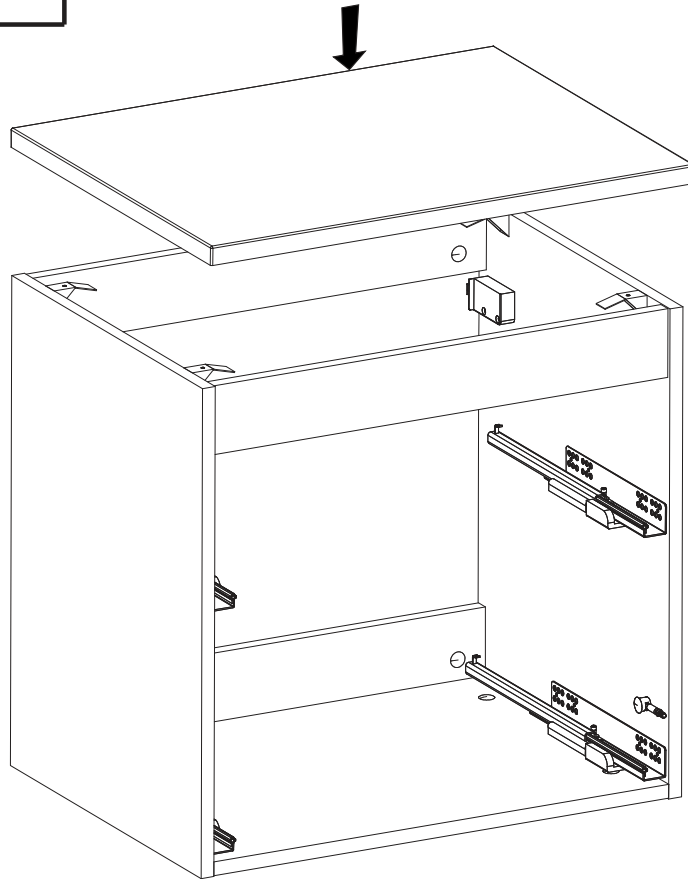

4

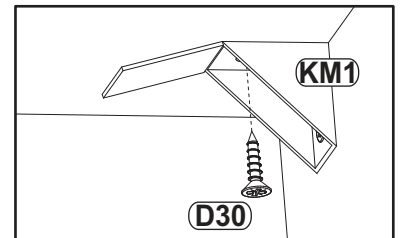
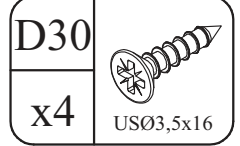
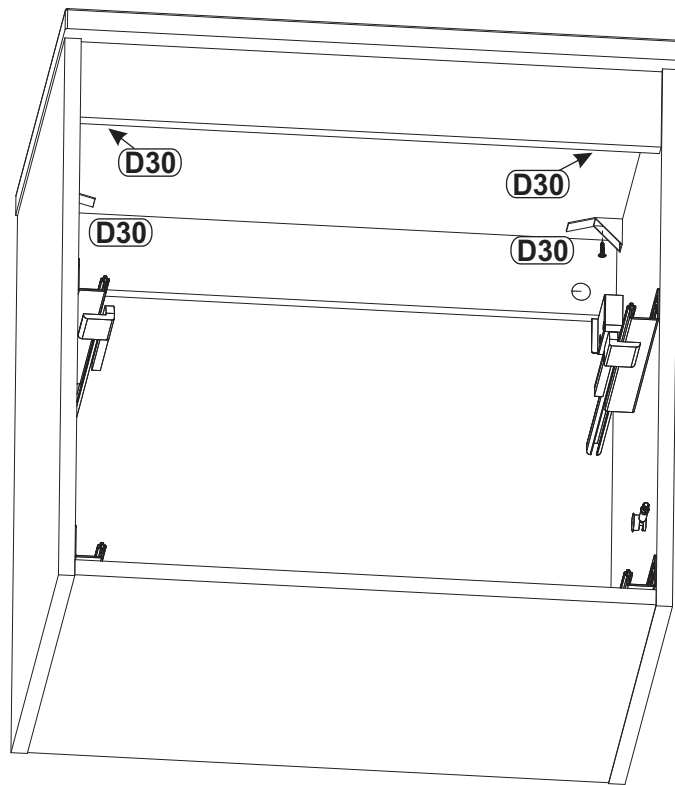

BLAT 60 CM BL850, 89-60-B  
BLAT 80 CM BL851, 89-80-B

5

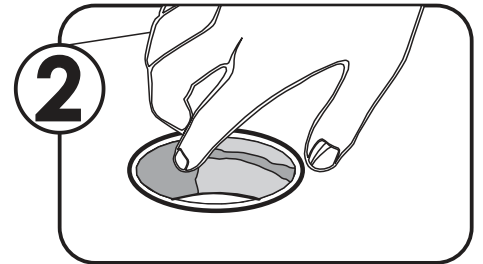
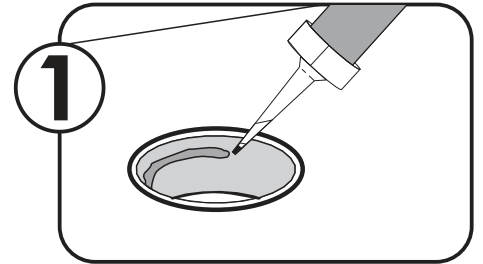
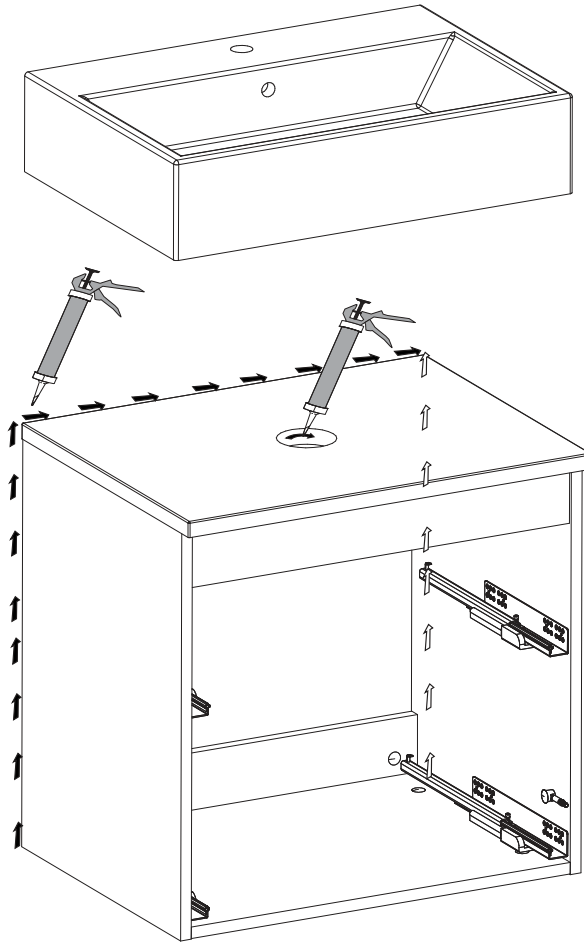

6

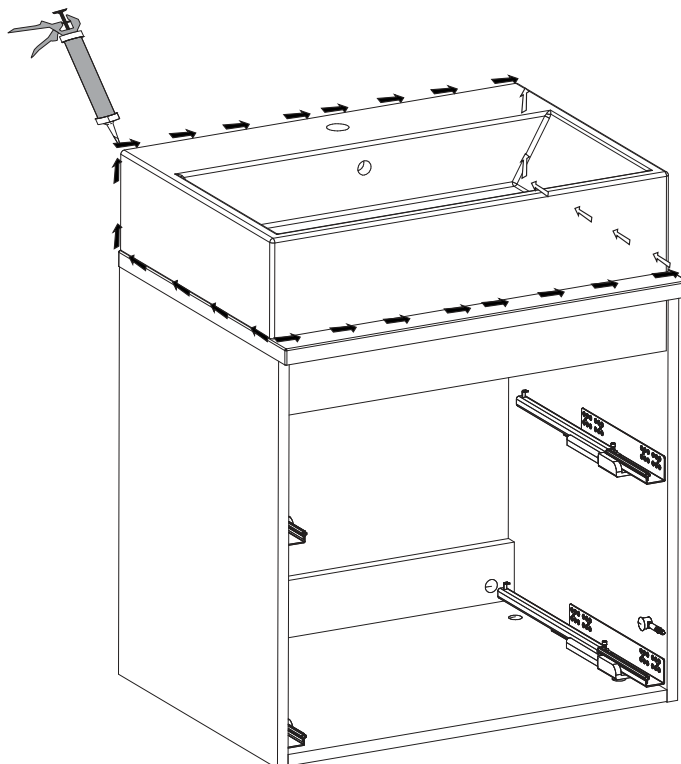

BLAT 60 CM BL850, 89-60-B  
BLAT 80 CM BL851, 89-80-B

7

1

2

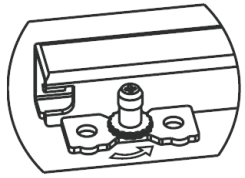

↑ +4 mm

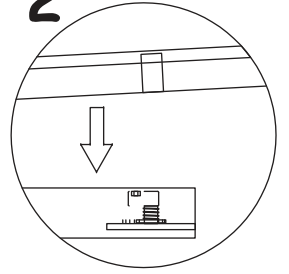
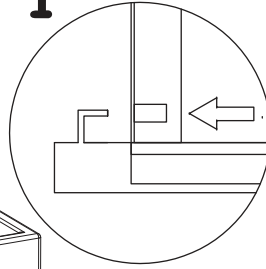
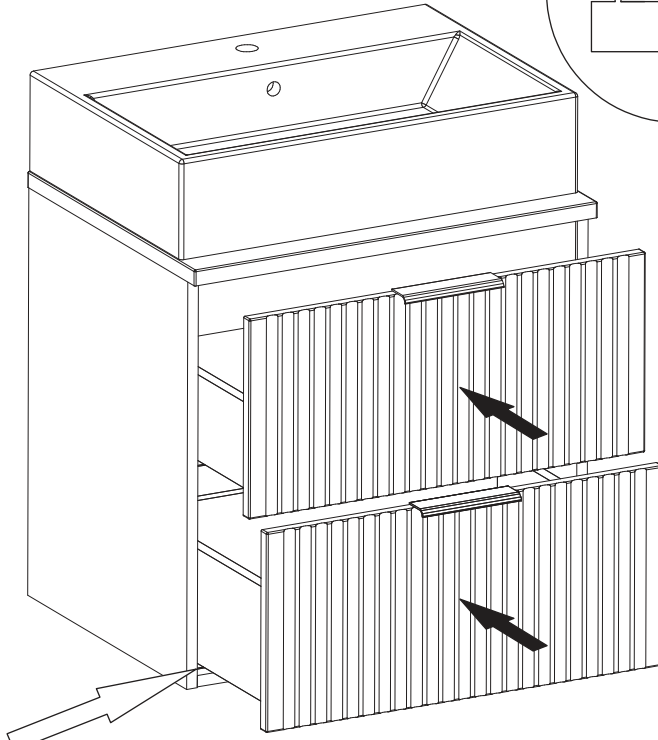

8

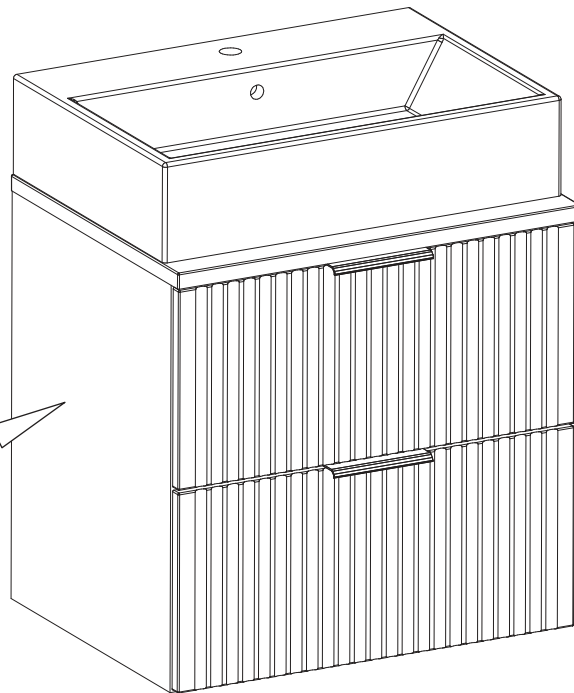

# SŁUPEK WYSOKI 1D 80-01-B-1D

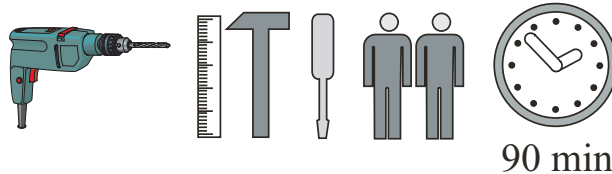
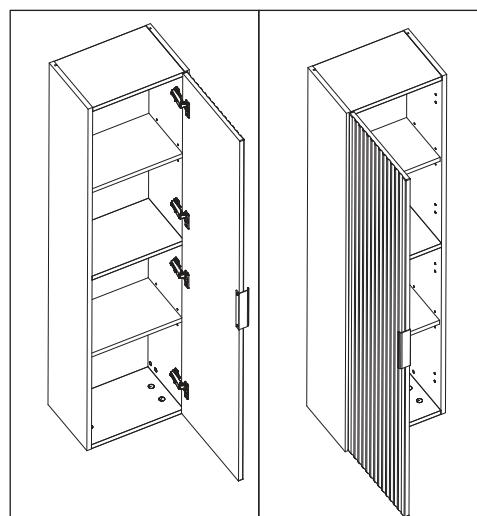
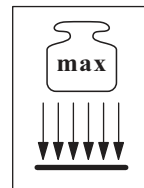
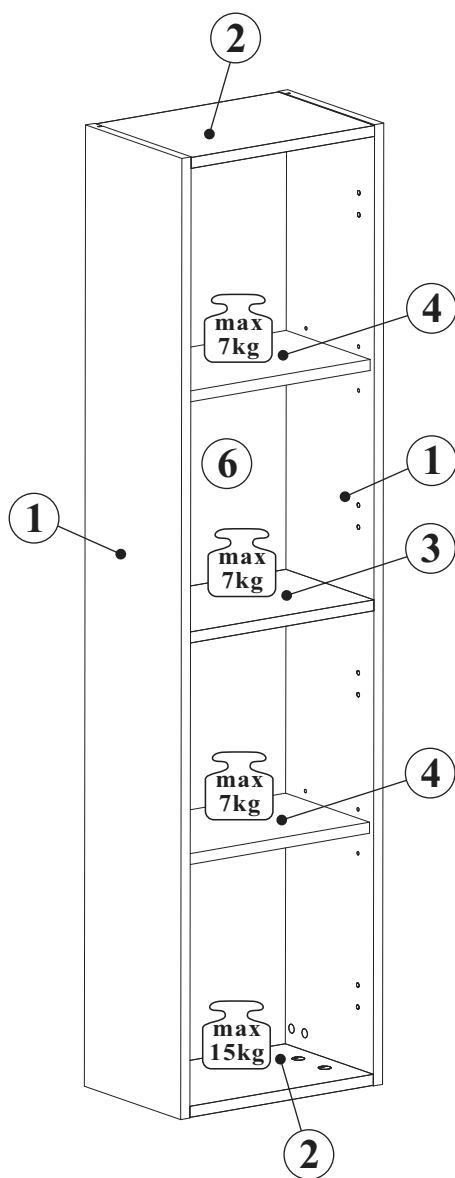
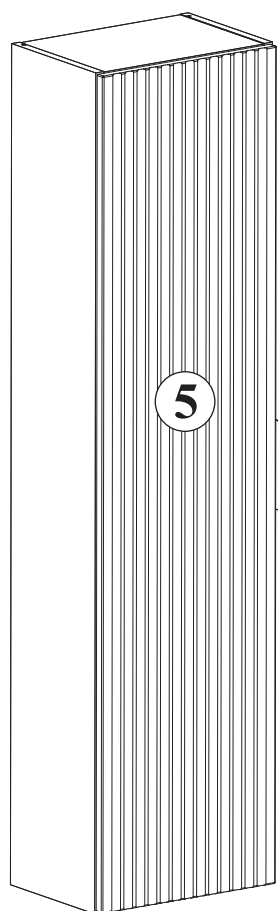

NO	Dim.			Col.-No	Qty
1	1400	234	16	1	2
2	318	234	16	1	2
3	318	214	16	1	1
4	318	204	16	1	2
5	1394	344	16	1	1
6	1378	330	3	1	1



# SŁUPEK WYSOKI 1D 80-01-B-1D

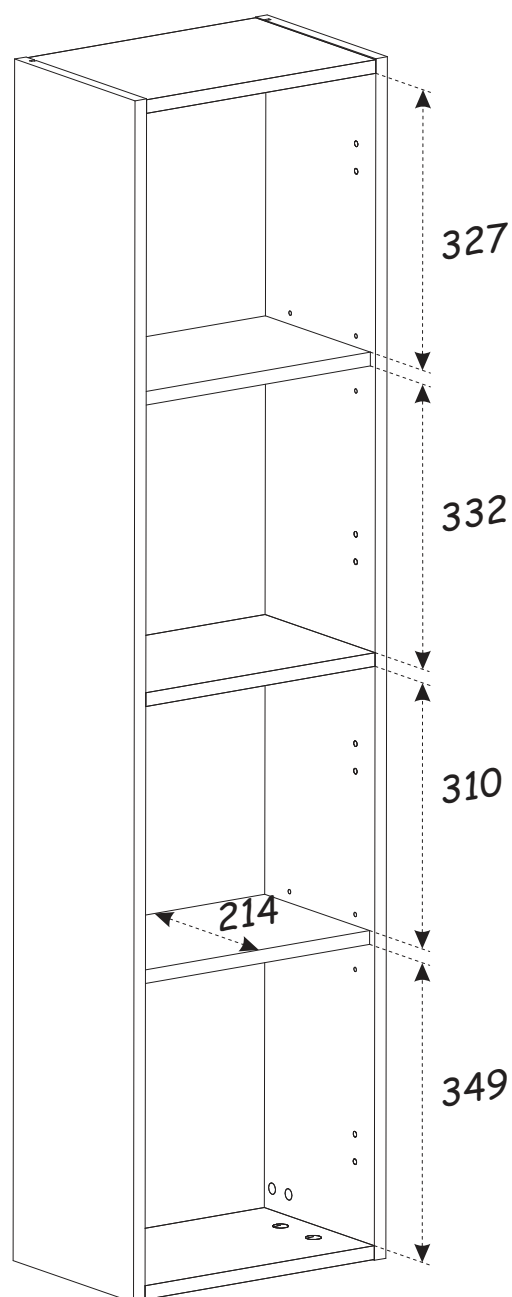
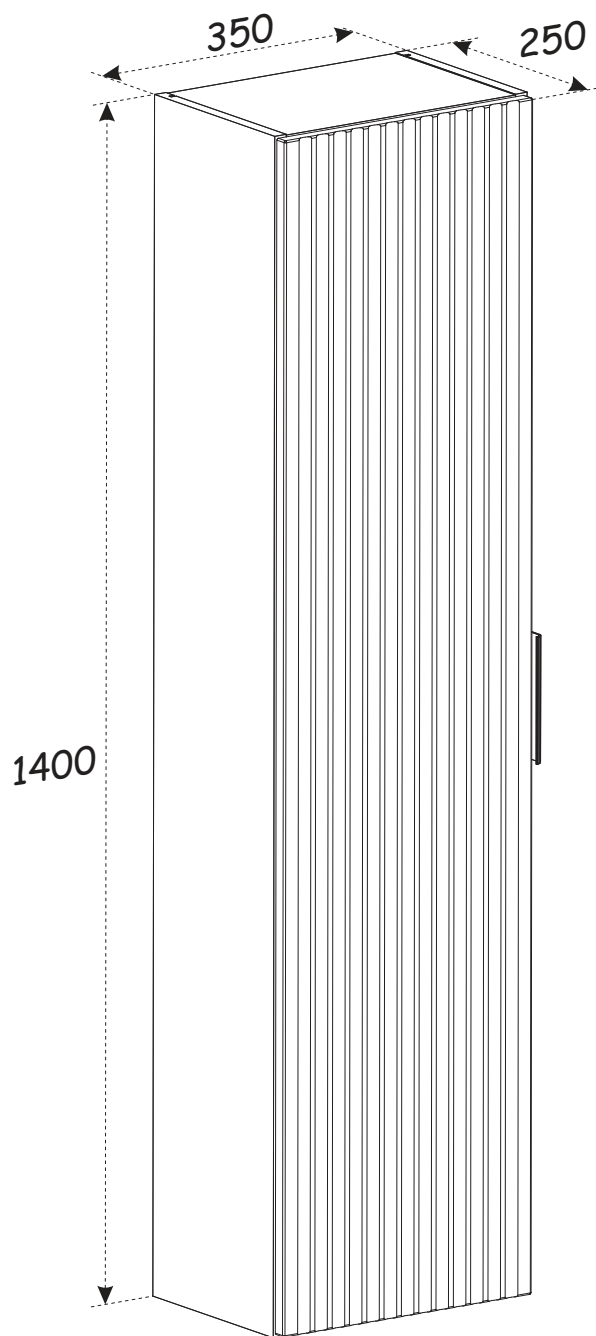

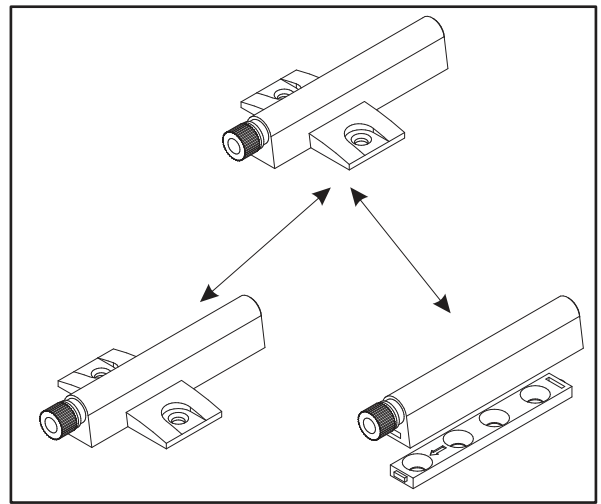
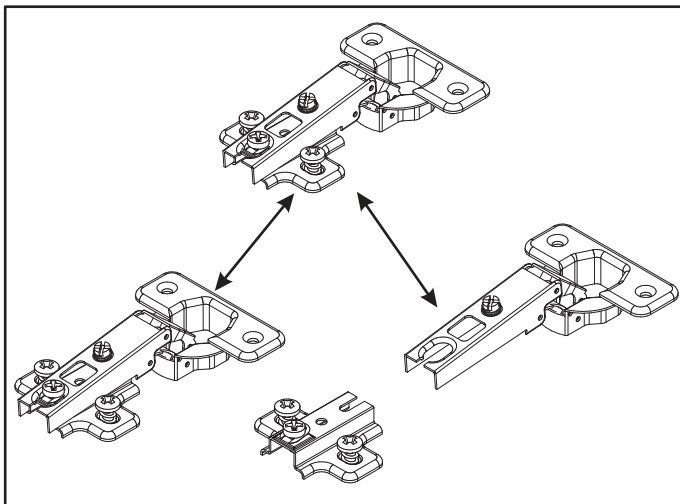
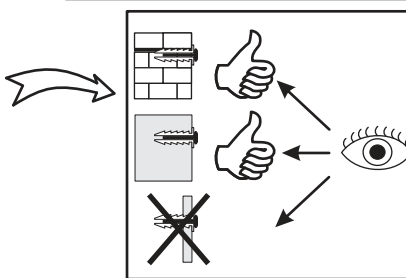
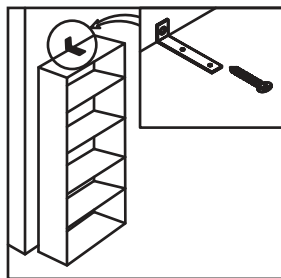
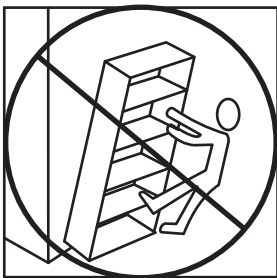
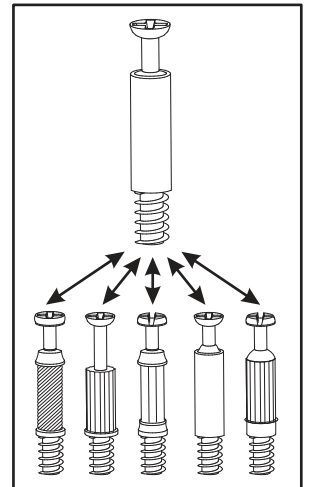
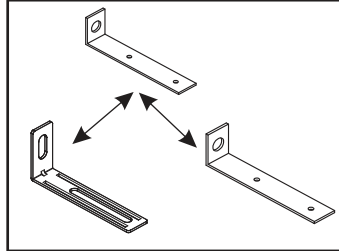
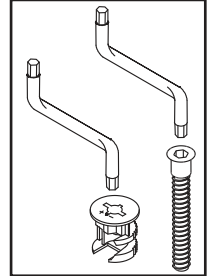
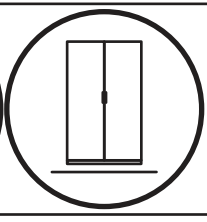
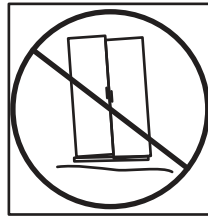
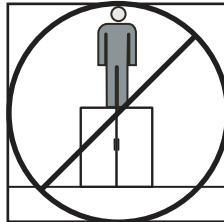
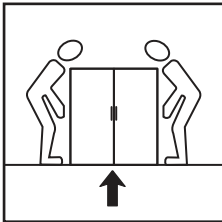
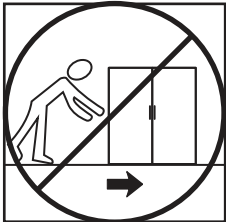
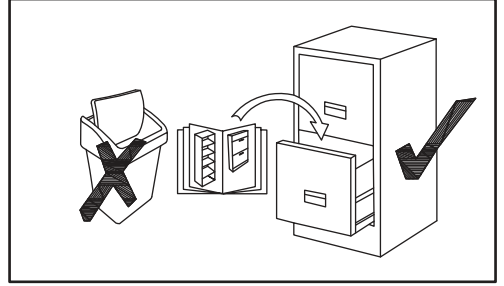
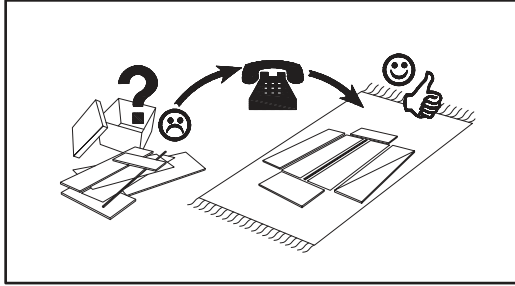
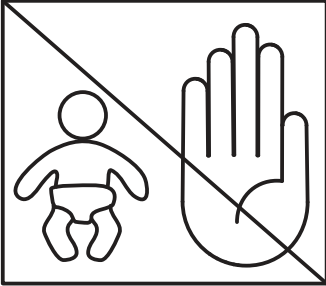
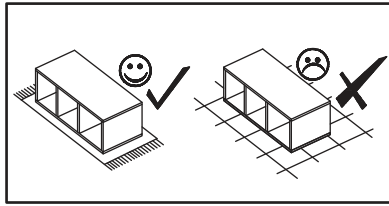
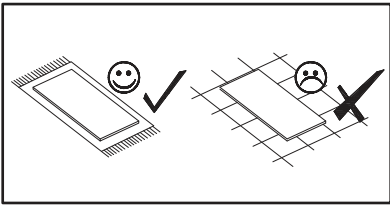

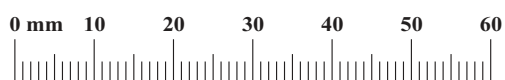

SŁUPEK WYSOKI 1D 80-01-B-1D

A1 x12 ø8x36	B4 x12	B5 x12 ø15x12	G5 x12	ZXP x1	ZXL x1
E21 x4 Ø35 H=0	E2 x4 H=0	D10 x8 USØ3,5x13	G7 x8	Z2 x8 Ø5	Z5 x4 Ø10
S1 x8	G04 x1 L-148mm.	SZ7 x2	KR1 x4	D7 x2 USØ3x16	D6 x4 USØ3,5x30
UP13 x3 UPØ3x16	G2 x1				

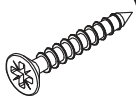

1

D6	
x4	USØ3,5x30

Z5	
x4	Ø10

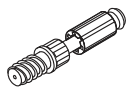
B4	
x12	

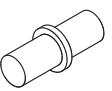

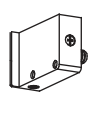
G7	
x8	

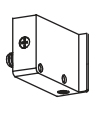
ZXP	
x1	

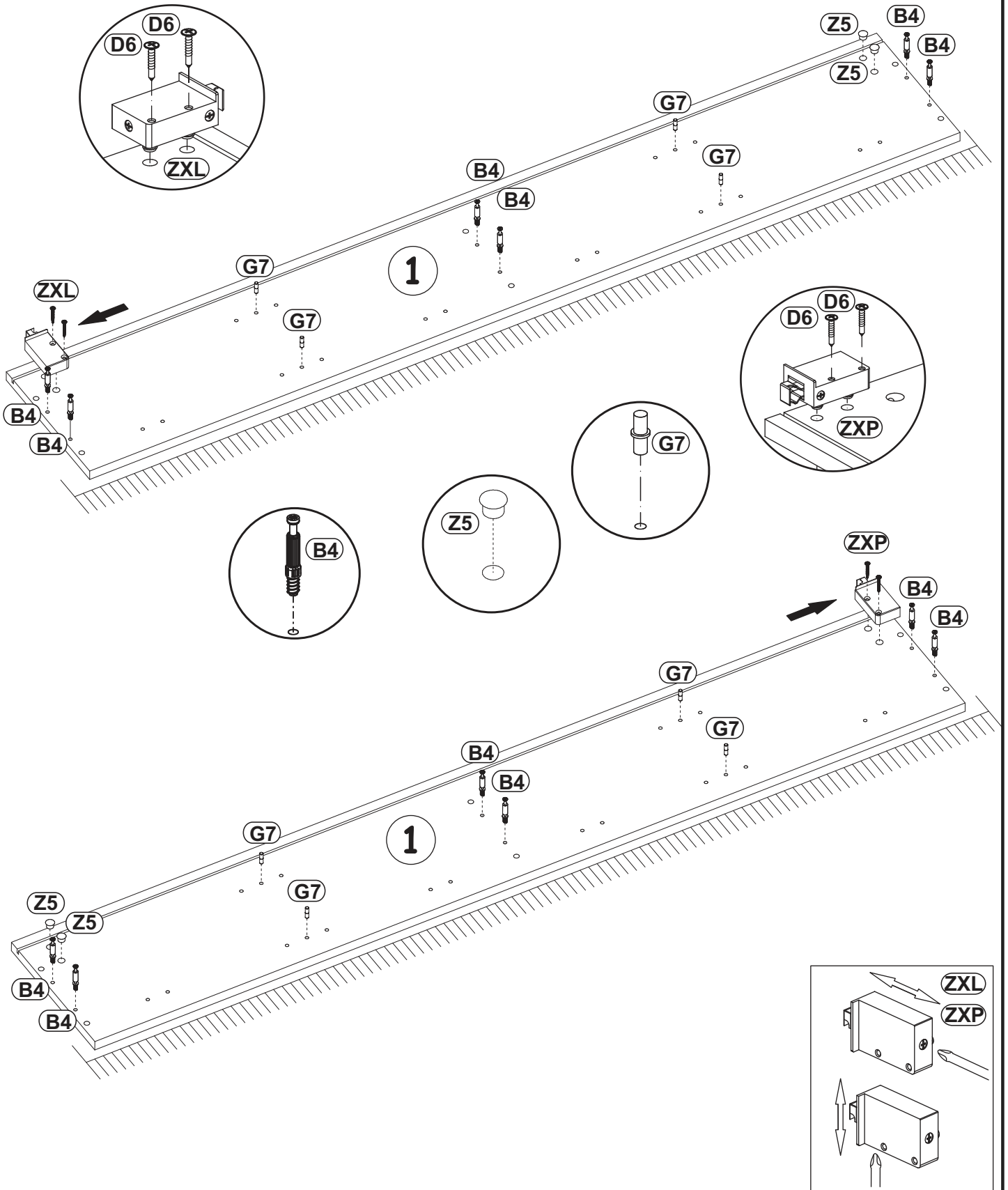
ZXL	
x1	



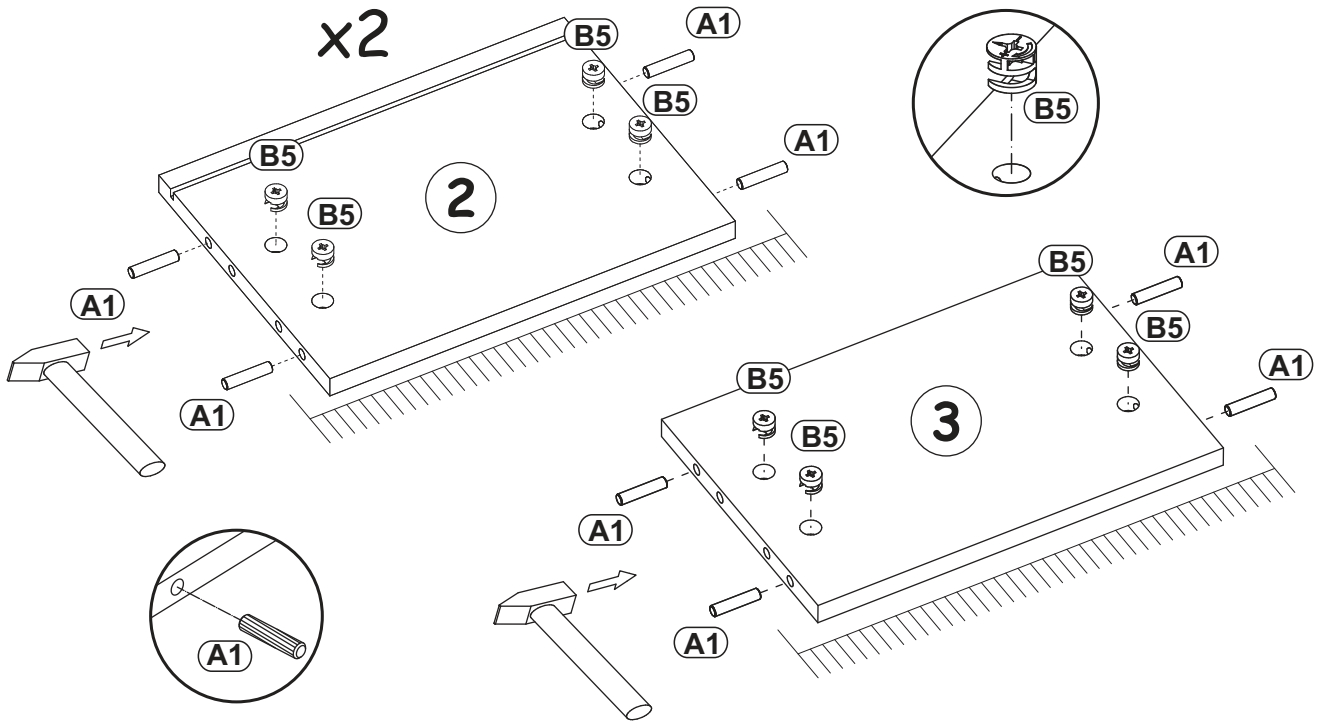

2

A1		B5	
x12	ø8x36	x12	ø15x12



3

D10		E21	
x8	USØ3,5x13	x4	Ø35 H=0

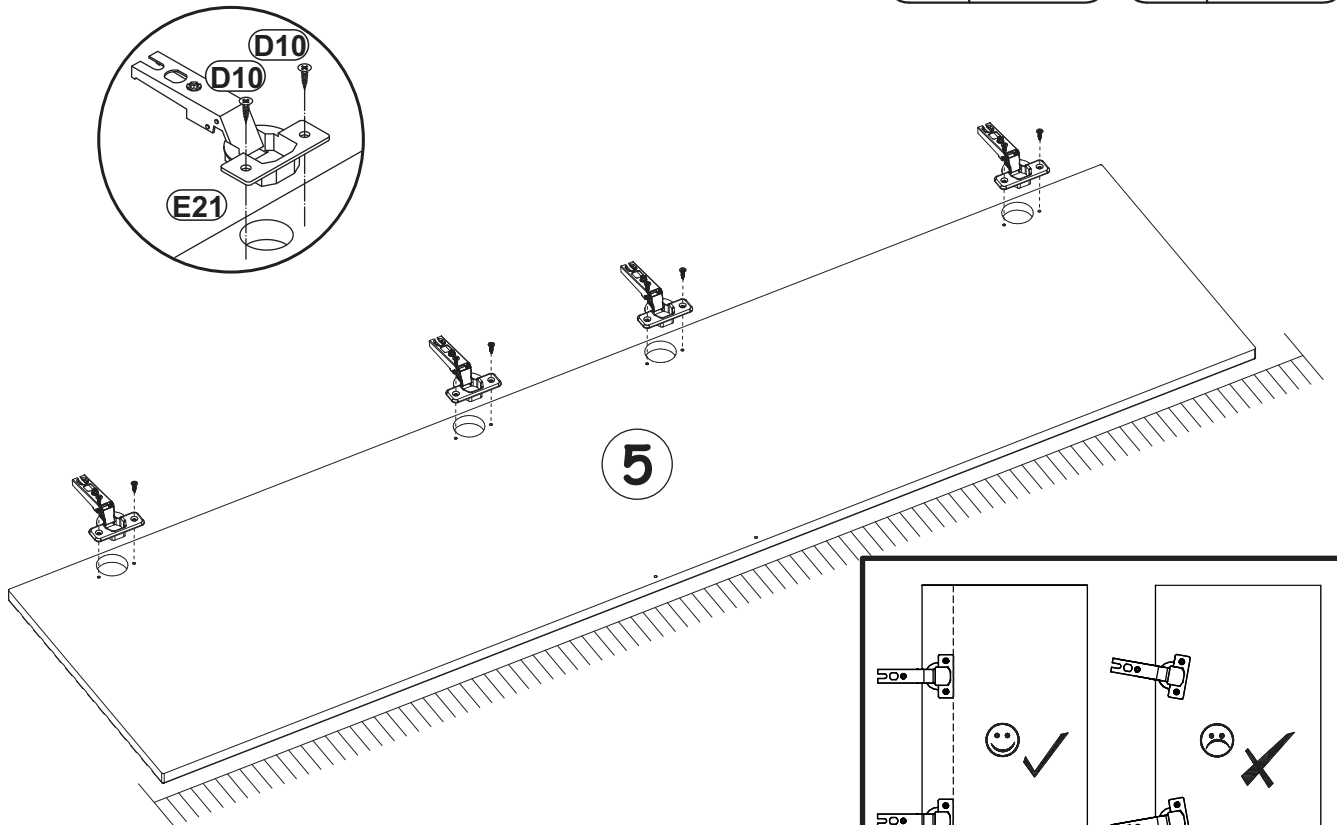

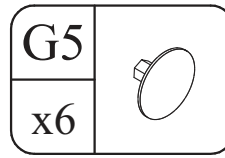

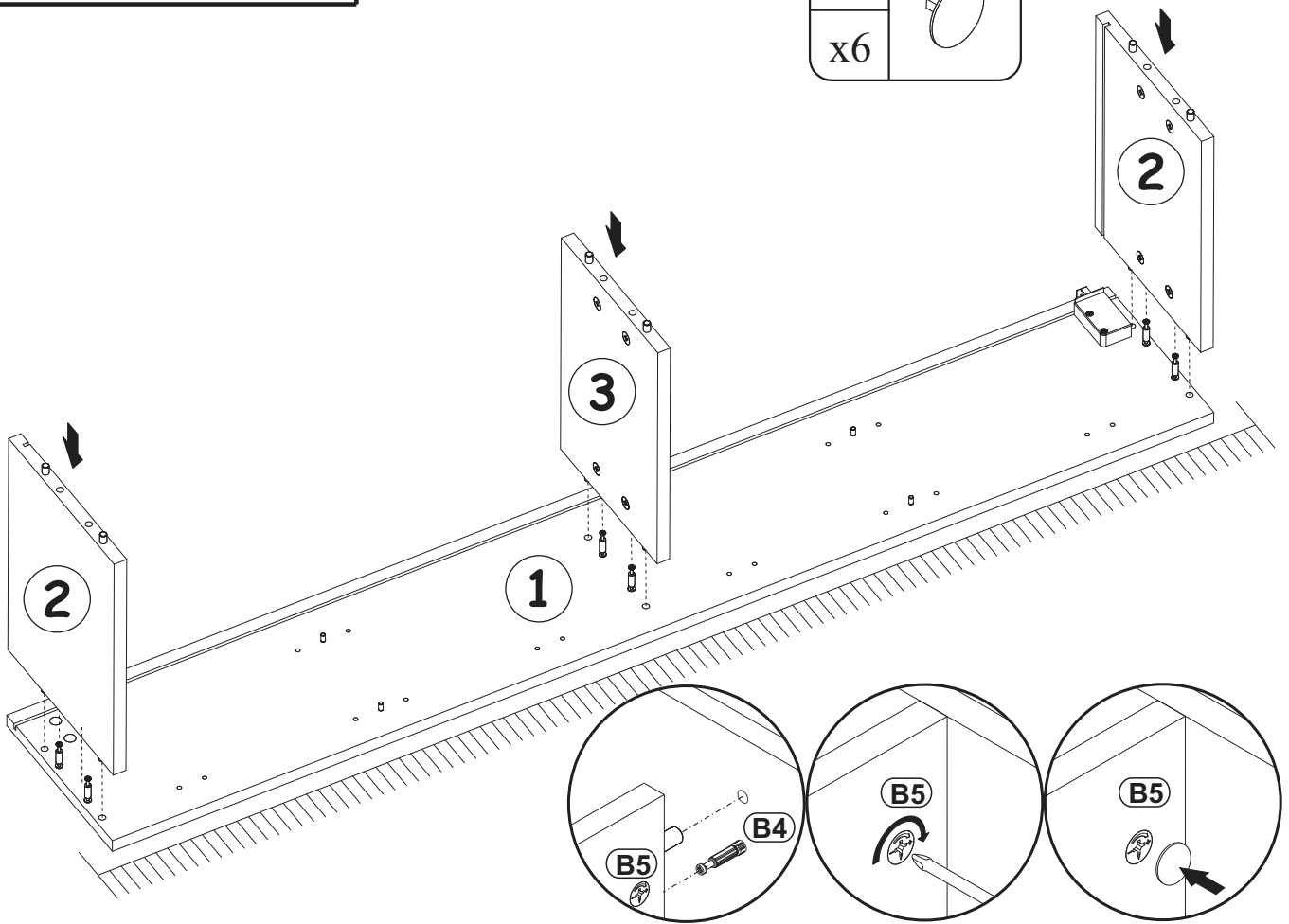

4

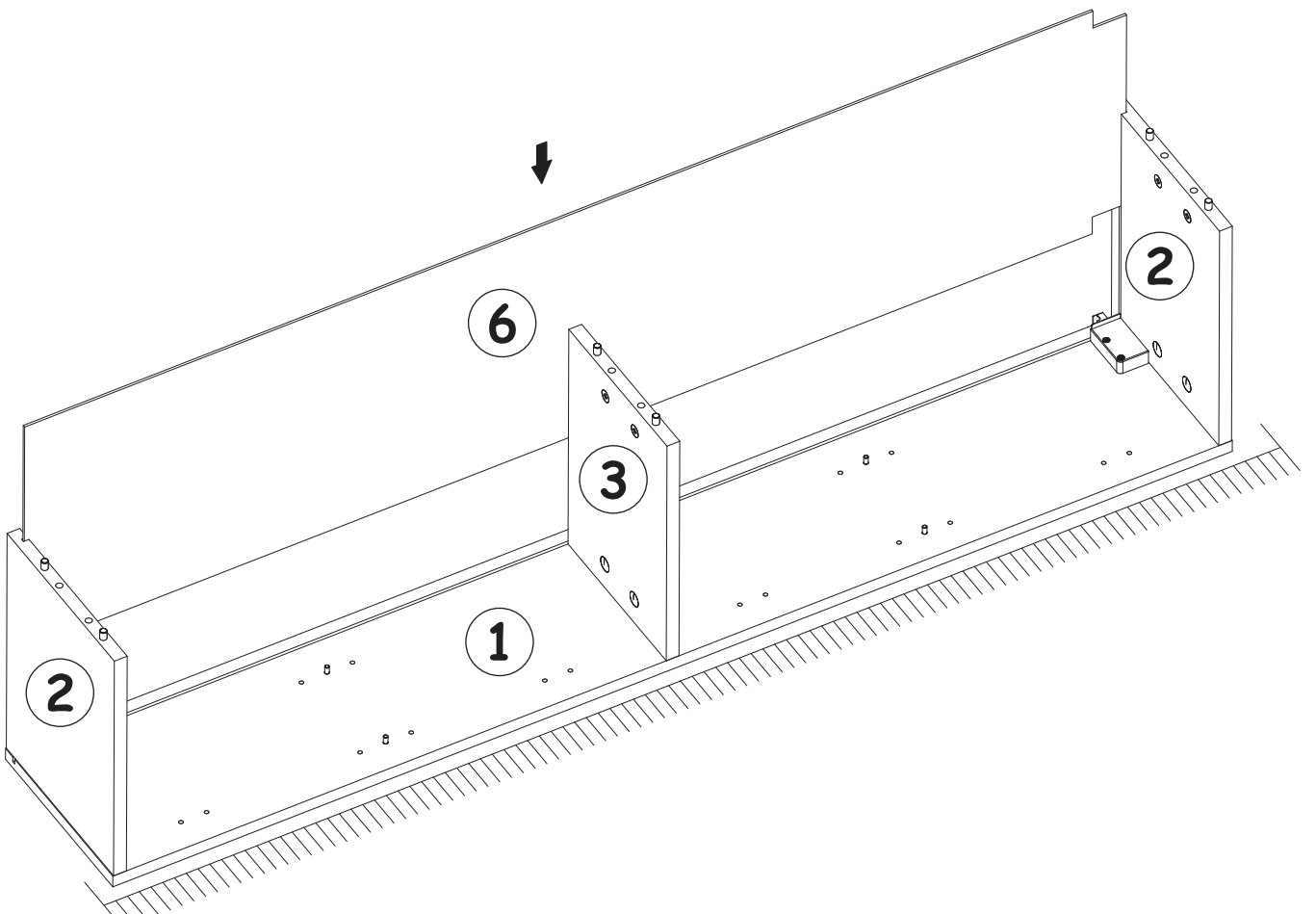

5



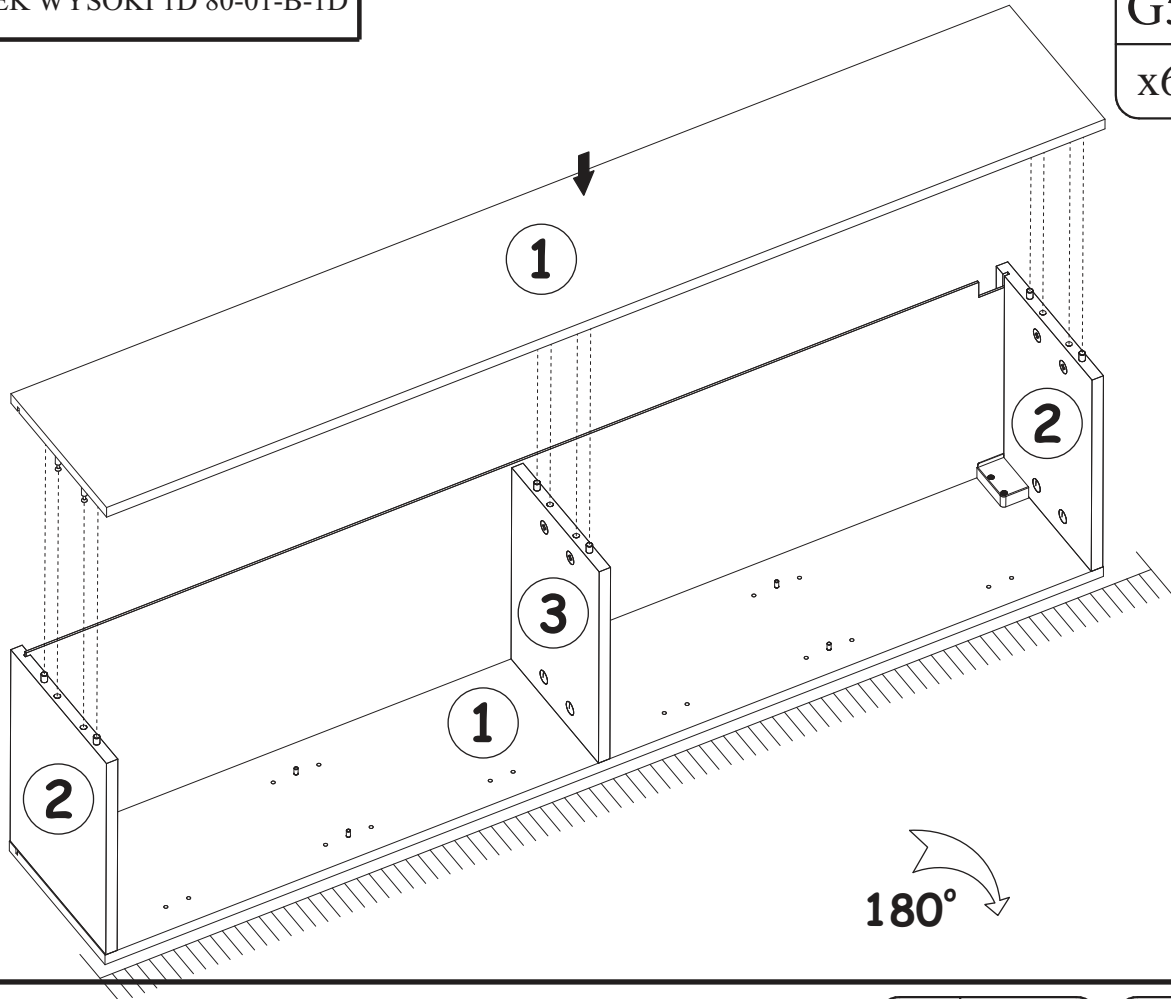

6

G5	
x6	

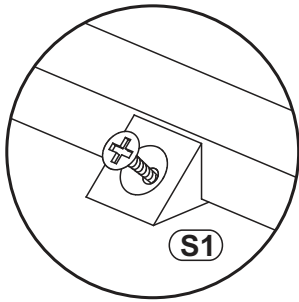

7

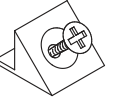

UP13		S1	
x3	UP03x16	x8	

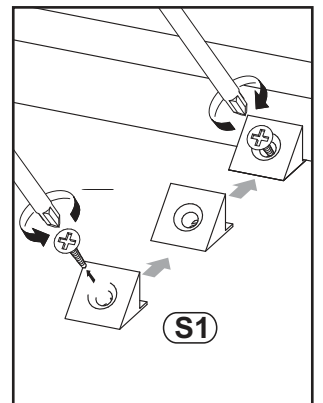
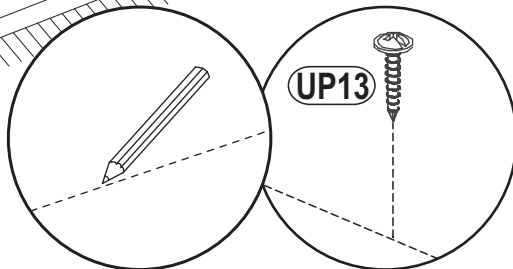
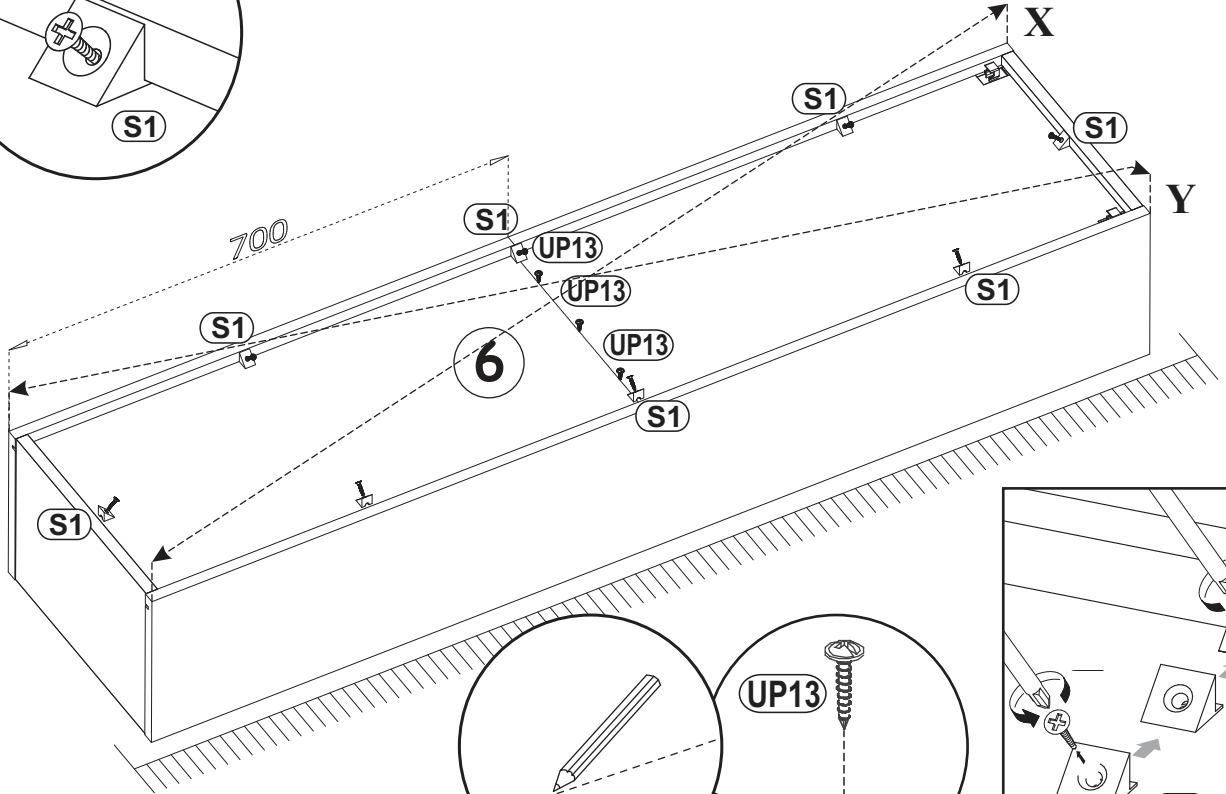

8

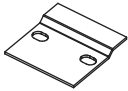
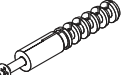
SZ7		KR1	
x2		x4	

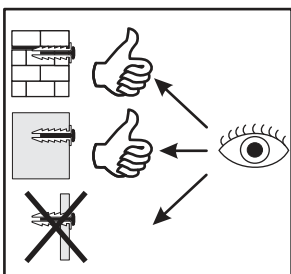
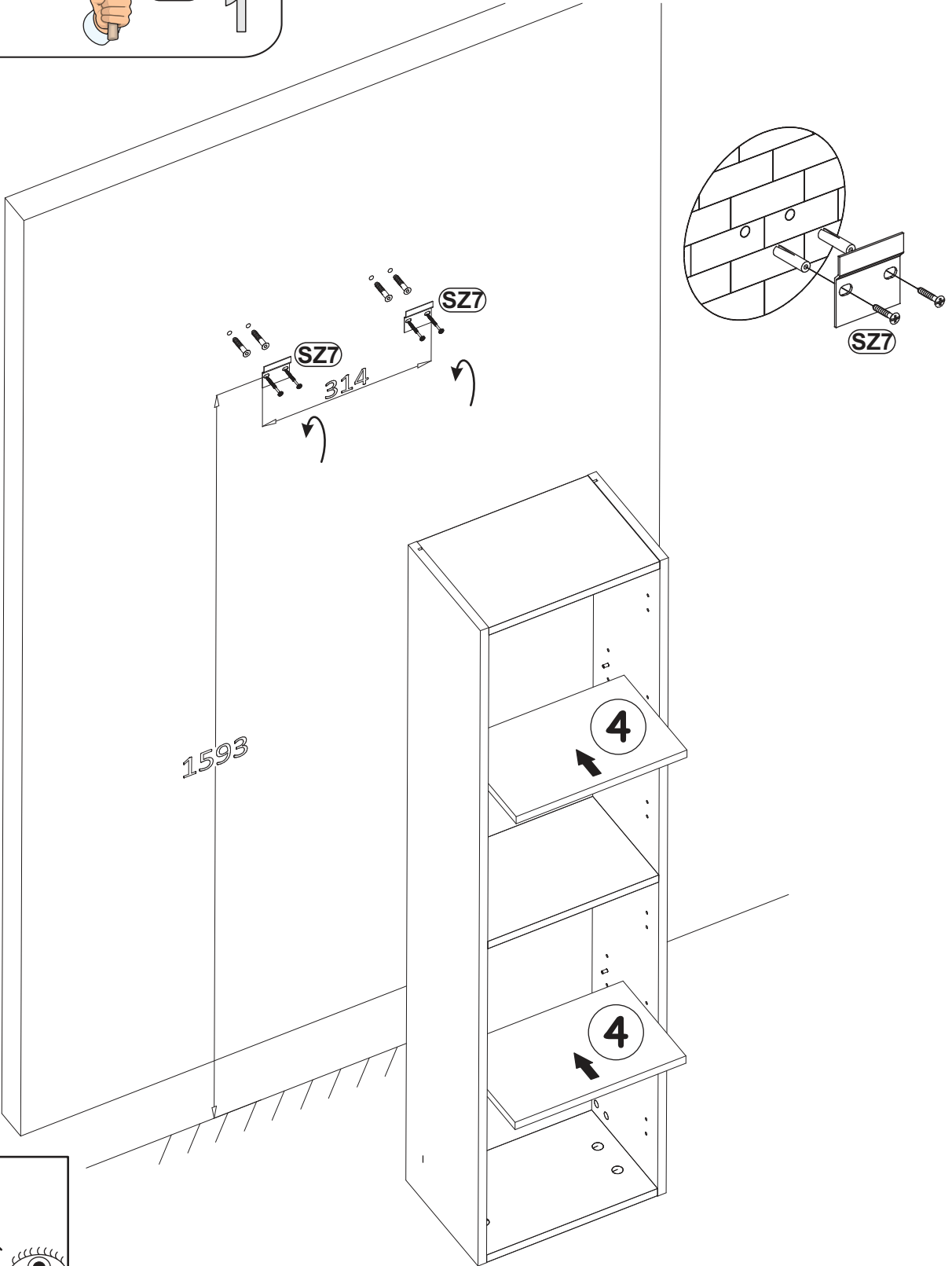
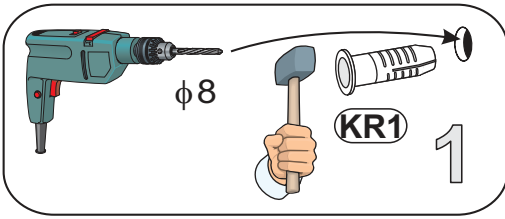



**9-11**

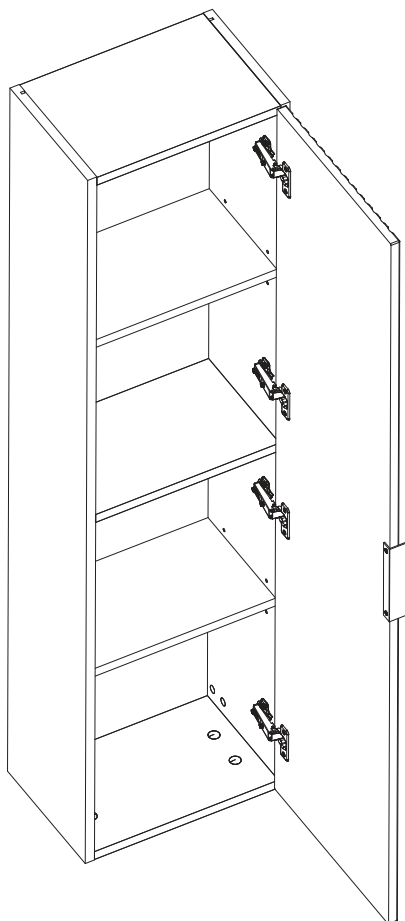

**12-14**

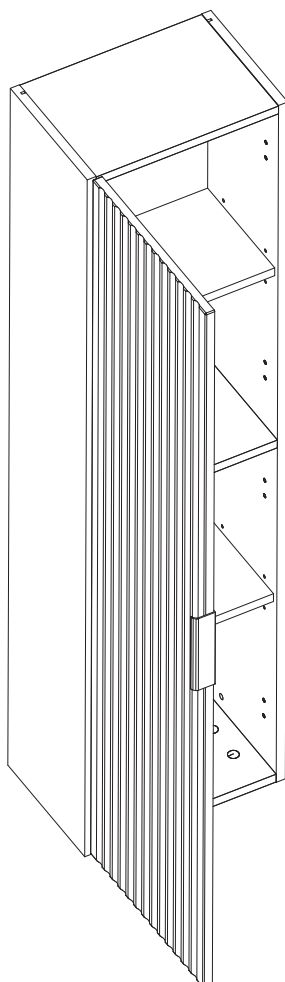

9

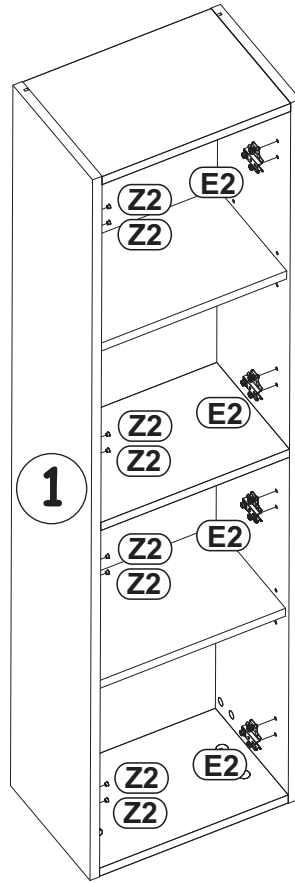
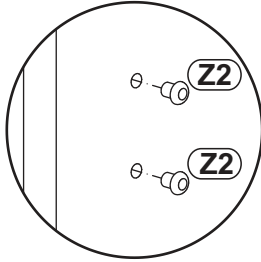
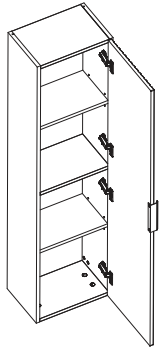

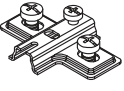
Z2		E2	
x8	Ø5	x4	H=0

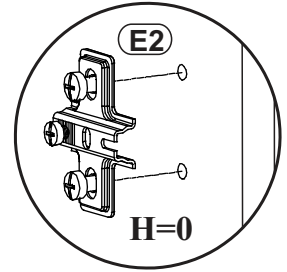

10

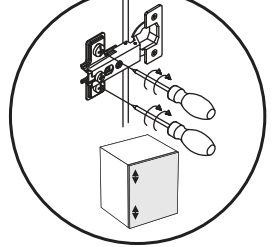
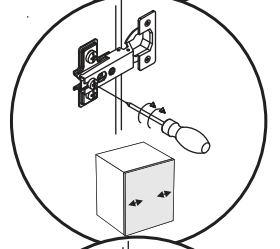
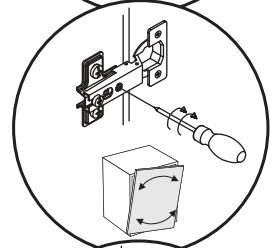
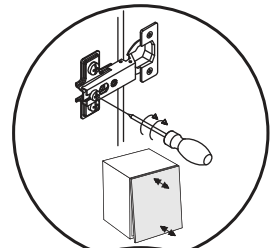
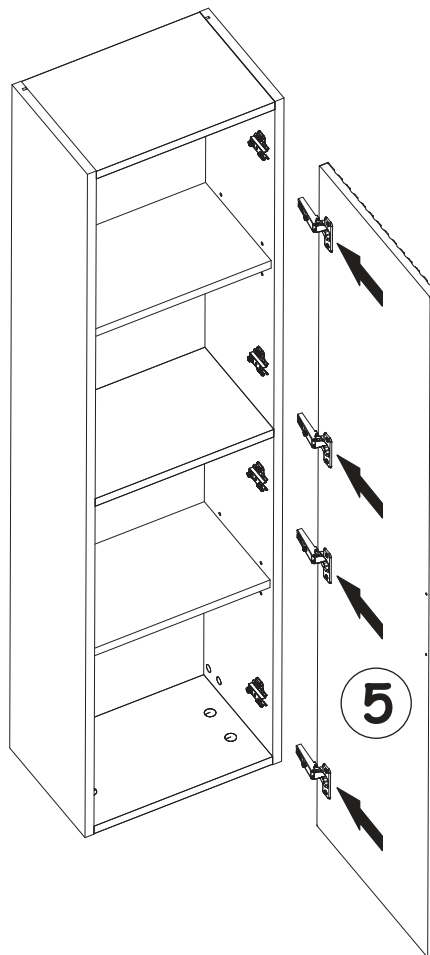
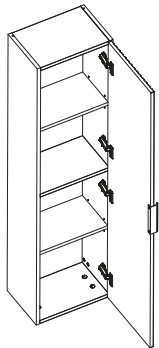

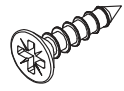
D7	
x2	USØ3x16

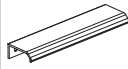
G04	
x1	L-148mm.

11

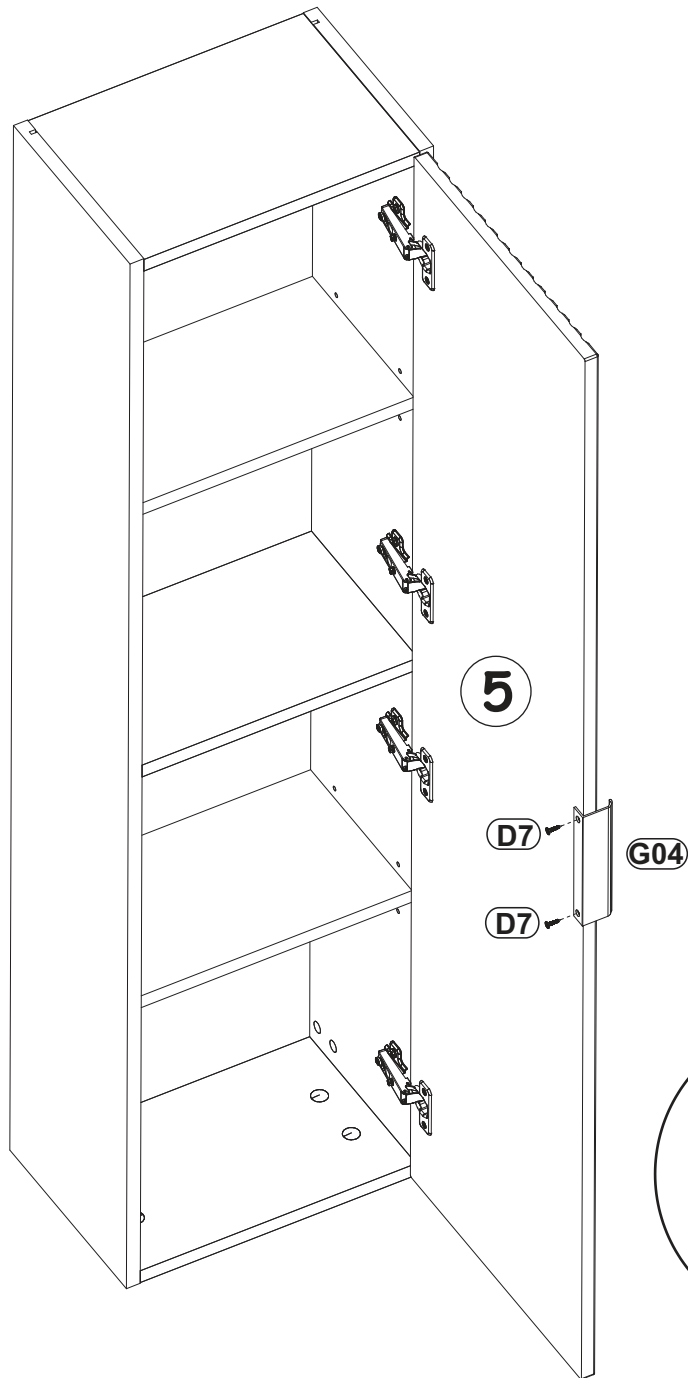
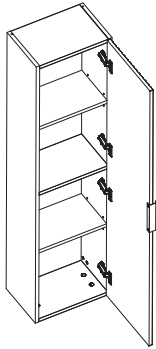

12

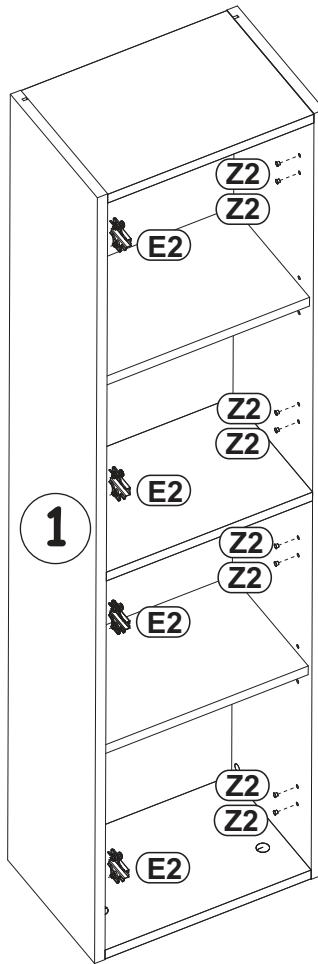
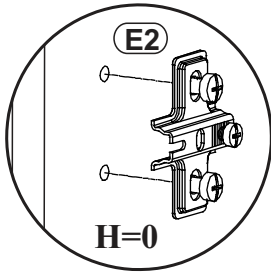
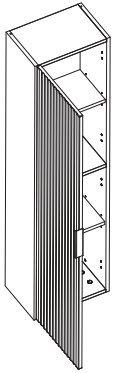

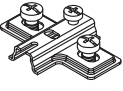
Z2		E2	
x8	Ø5	x4	H=0

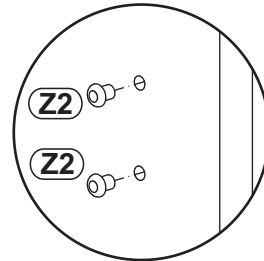

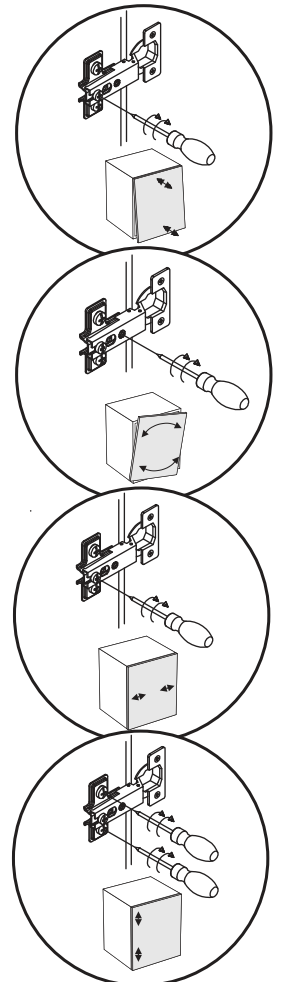
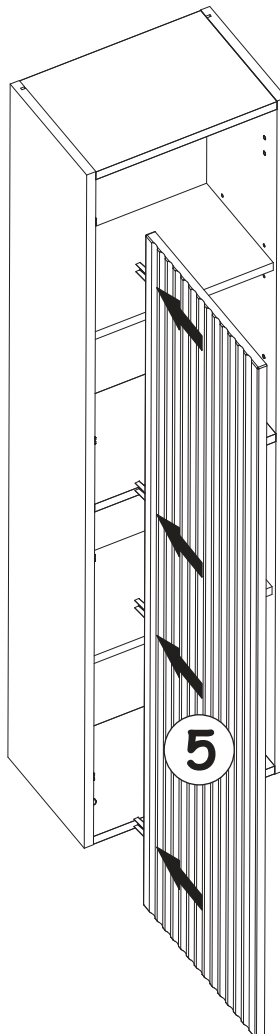
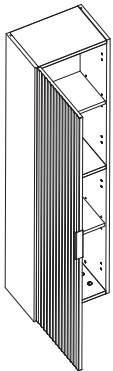

13

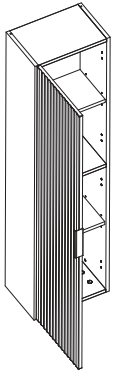

14

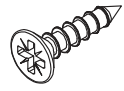

D7		G04	
x2	USØ3x16	x1	L-148mm.

