

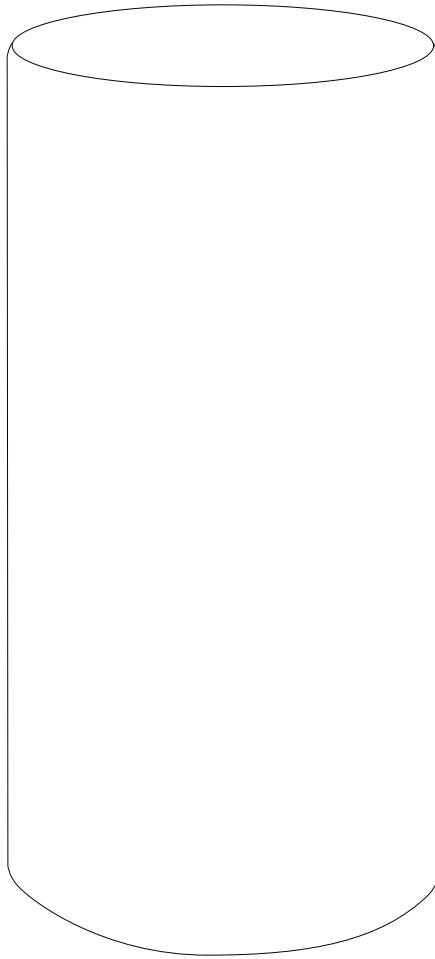

**PIEDRA**

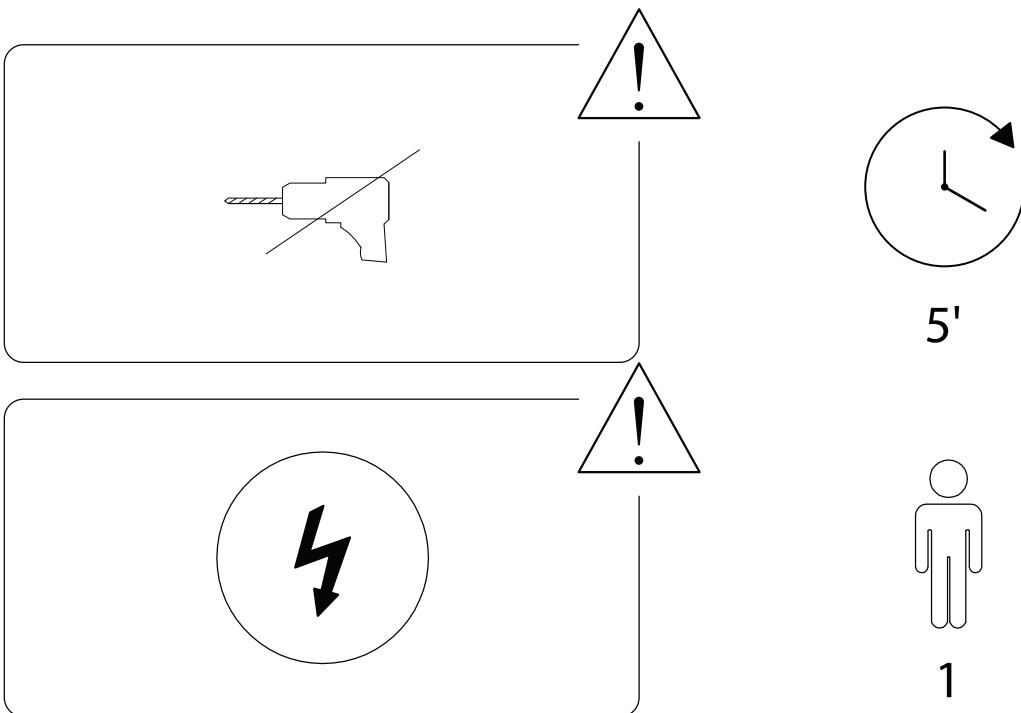

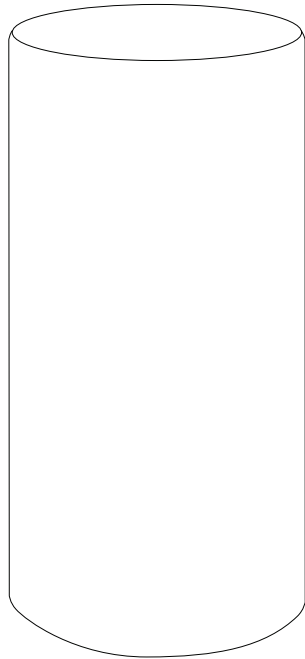
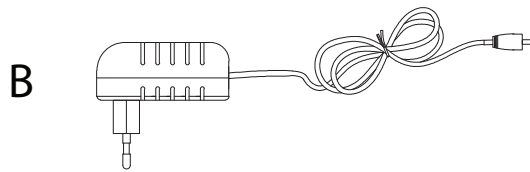
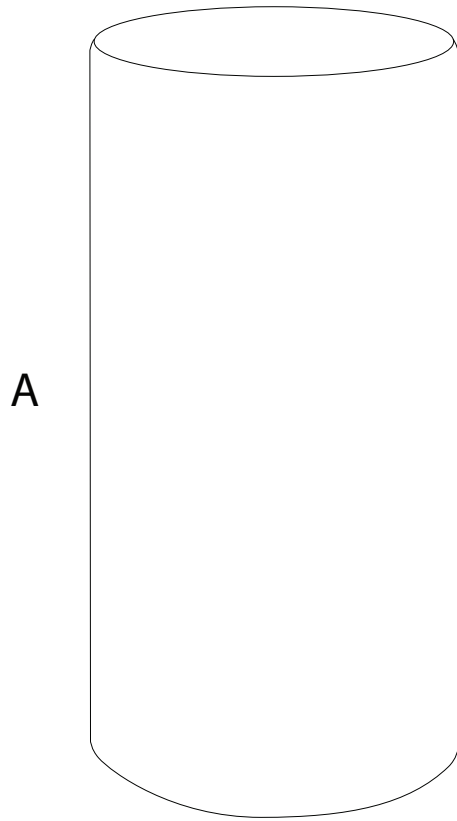

1/4

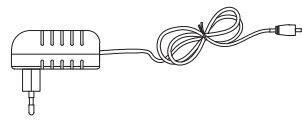
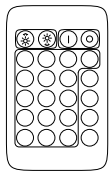

A	B	C
		
x 1	x 1	x 1

1

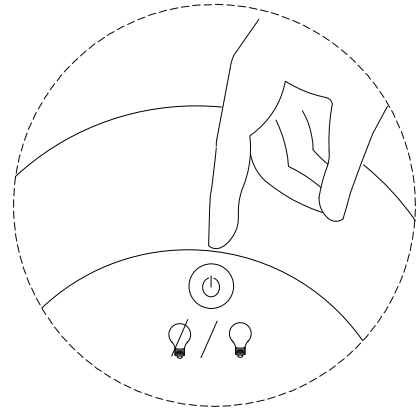
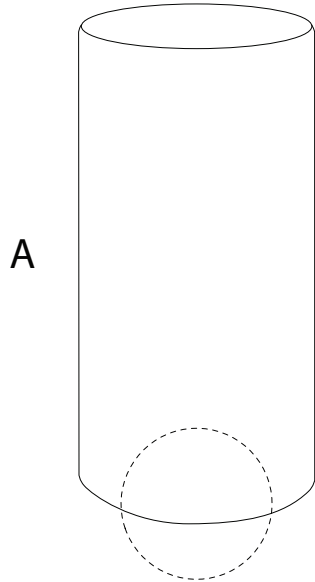

2

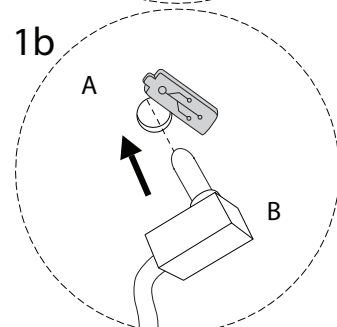
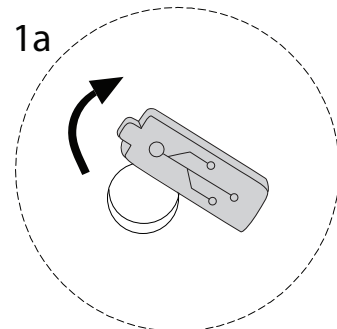
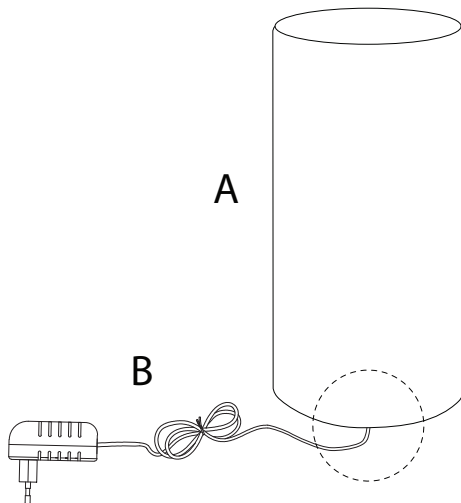
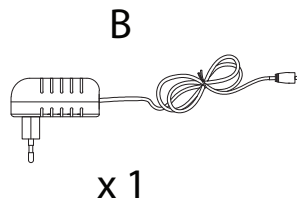

3

