

GUIDE D'INSTALLATION DU MIROIR LED/LED MIRROR INSTALLATION GUIDELINE  
RICHTLINIEN ZUR INSTALLATION VON LED-SPIEGELN/GUÍA DE INSTALACIÓN DEL ESPEJO LED  
LINEE GUIDA PER L'INSTALLAZIONE DI SPECCHI A LED/LED SPIEGEL INSTALLATIE RICHTLIJN  
DIRETRIZES DE INSTALAÇÃO DO ESPELHO DE LED/WYTYCZNE DOTYCZĄCE INSTALACJI LUSTEREK LED

# LIMORICO

MIROIR AVEC LED

135623



FR

Pensez à  
donner ou recycler.



Association

ou



Magasin

ou



Déchèterie

<https://quefairedemesdechets.fr>



Vente-unique.com

# Guide d'installation du LIMORICO ML8673 (500\*800)

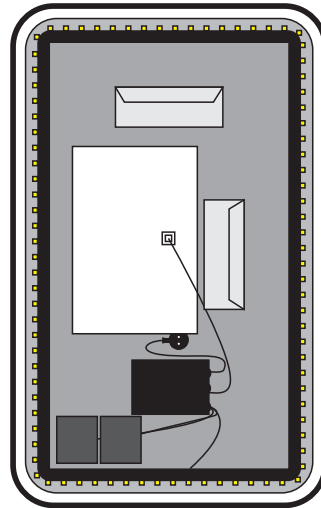

## COMPOSANTS

1.38±0.05 M

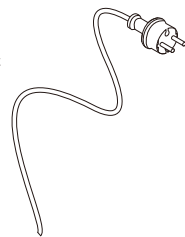
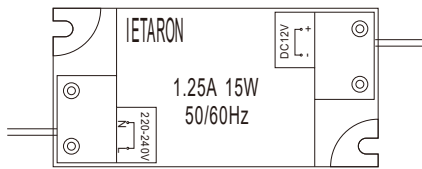

Ceinture à LED: 2835-60-6000K

## Instructions de maintenance

1. Lors de l'utilisation de l'armoire du miroir, veuillez ne pas mettre de produit chimique qui incluent de l'acide, de l'alcalin et autres produits chimiques corrosifs sur le cadre de l'armoire afin d'éviter d'endommager la surface de l'armoire.
2. Veuillez ne pas mettre de gaz volatile dans l'armoire du miroir.
3. Veuillez ne pas mettre de serviette humide ou serviette de bain dans l'armoire, ne touchez spécialement pas le cadre de l'armoire afin d'éviter l'oxydation.
4. Lors de l'utilisation de l'armoire pendant longtemps, après que le miroir de la porte devienne sale, vous pouvez utiliser un mélange de 70% C<sub>2</sub>H<sub>5</sub>OH et 30% d'eau pour nettoyer le miroir.
5. Le côté du miroir est spécialement réglé, veuillez utiliser un chiffon doux pour le nettoyer, et gardez le côté du miroir sec, veuillez ne pas utiliser de produits chimiques acides pour le nettoyer.

## OUTILS



PERCEUSE ÉLECTRIQUE



RÈGLE



MARTEAU

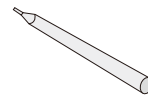

CRAYON



MÈTRE RUBAN

1. Mettez un support 250 B à l'horizontale sur le mur. Marquez la position du trou et le bord.

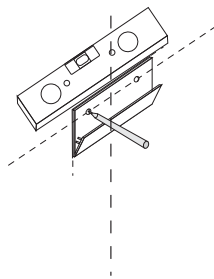

2. Percez les trous à une profondeur de 40mm de diamètre Ø8 sur la position des 2 marques, et poussez le tuyau d'expansion élastique à l'intérieur.

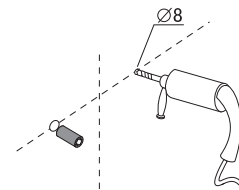

3. Comme indiqué sur le schéma, fixez le support au mur avec des vis.

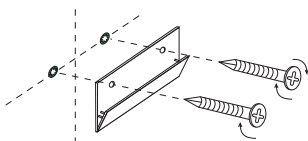

4. Mettez le miroir sur le mur comme indiqué sur l'image.

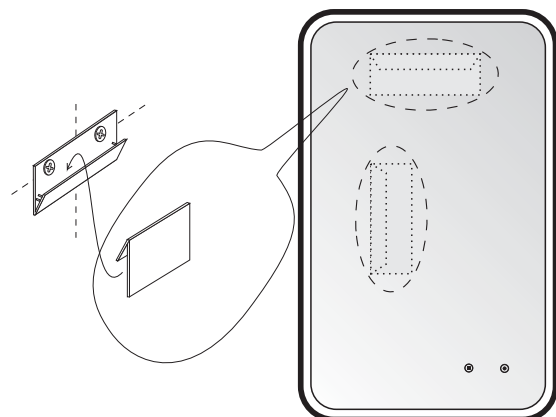

# Installation manual of LIMORICO ML8673 (500\*800)

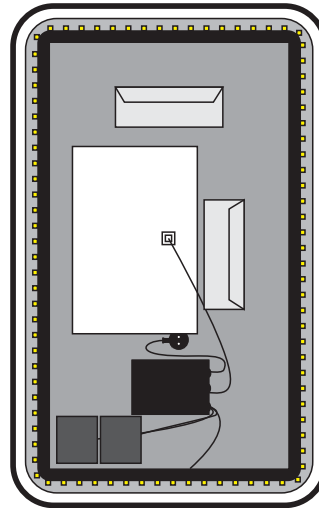

## COMPONENTS

1.38±0.05 M

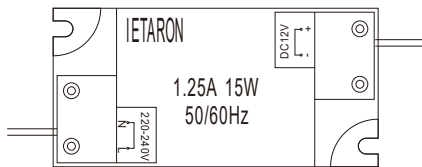

LED Belt: 2835-60-6000K

## Maintenance Instruction

1. When use the mirror, please don't put the chemicals which including acid, alkaline and other corrosive chemicals on the frame of the mirror so that could avoid to affect the surface of the mirror.
2. Please don't put some volative gas in the mirror.
3. Please don't put the wet towel or bath towel in the cabinet, especially don't touch the frame of the mirror so that could be avoid of oxidation.
4. When use the mirror for a long time, after the mirror is not clear,we could use the Mixture of 70% C<sub>2</sub>H<sub>5</sub>OH and 30% water to clear the mirror.
5. The side of mirror is dealt specially, please use soft cloth to clear it, and keep the side of the mirror dry. Please don't use acid chemicals to clear it.

## TOOLS



ELECTRIC DRILL



RULER



HAMMER

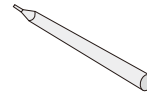

PENCIL



TAPE MEASURE

1. Put a 250-Bracket B in horizontal on the wall. Mark the position of the hole and the edge.

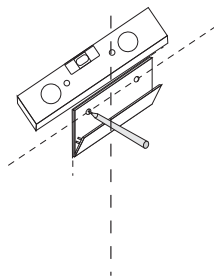

2. Drill Ø8 in 40MM depth holes in the position of the 2 marks, and put the plastic-expansion pipe inside.

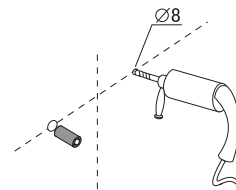

3. As followed picture, fix the bracket B on the wall with screws.

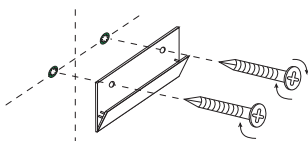

4. Put the mirror on the wall as picture.

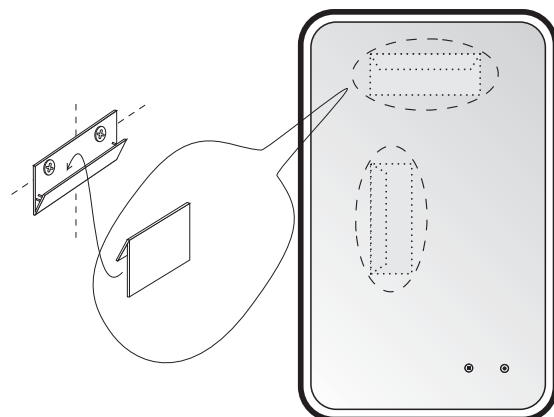

# Installationsanleitung für LIMORICO ML8673 (500\*800)

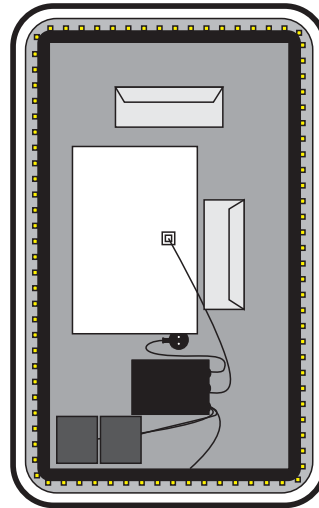

## KOMPONENTEN

1.38±0.05 M

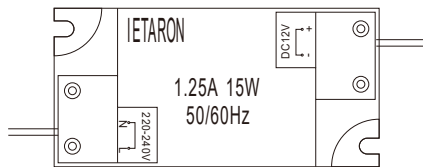

LED-Band: 2835-60-6000K

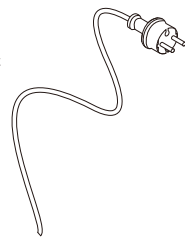

## Wartungsanleitung

1. Wenn Sie den Spiegelschrank benutzen, stellen Sie bitte keine Chemikalien, die Säure, Lauge und sonstige ätzenden Chemikalien enthalten, auf den Rahmen des Schrankes, damit sie nicht auf die Schrankoberfläche einwirken können.
2. Bitte kein flüchtiges Gas in den Spiegelschrank stellen.
3. Bitte legen Sie kein feuchtes Handtuch oder Badetuch in den Schrank, berühren Sie insbesondere den Rahmen des Schrankes nicht, um Oxidation zu vermeiden.
4. Bei längerer Verwendung des Schrankes und wenn der Türspiegel nicht klar ist, können wir eine Mischung aus 70 % C<sub>2</sub>H<sub>5</sub>OH und 30 % Wasser verwenden, um den Spiegel zu reinigen.
5. Die Seite des Spiegels ist speziell behandelt, nutzen Sie bitte für die einigung ein weiches Tuch und halten Sie die Seite des Spiegels trocken, bitte für die Reinigung keine säurehaltigen Chemikalien verwenden.

## WERKZEUG



BOHRMASCHINE



LINEAL



HAMMER

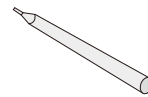

BLEISTIFT



MASSBAND

1. Bringen Sie eine 250-Halterung B horizontal an der Wand an. Markieren Sie die Position der Bohrung und der Kante.

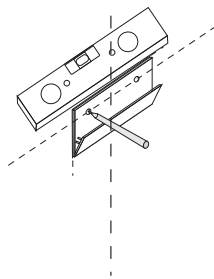

2. Bohren Sie Ø8-Löcher in 40 mm Tiefe in die 2 Markierungen und setzen Sie das elastische Dehnungsrohr ein.

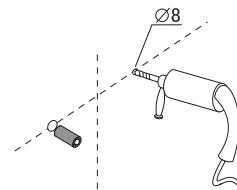

3. Laut nachstehender Abbildung befestigen Sie die Halterung mit Schrauben an der Wand.

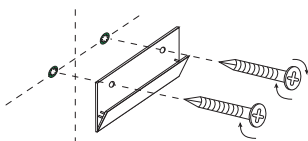

4. Bringen Sie den Spiegel an der Wand an, siehe Abbildung.

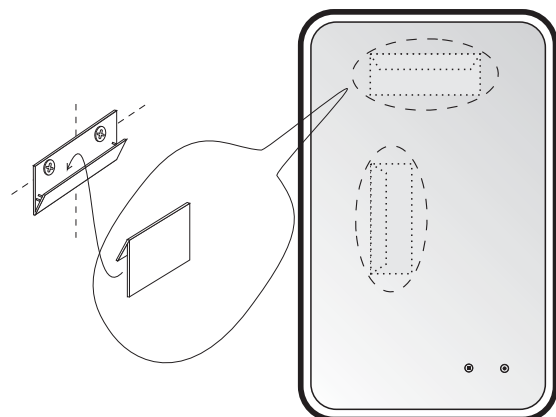

# Manual de instalación de LIMORICO ML8673 (500\*800)

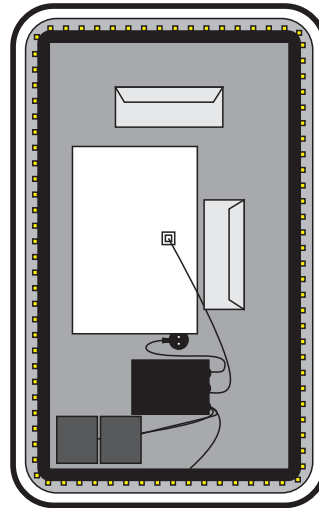

## COMPONENTES

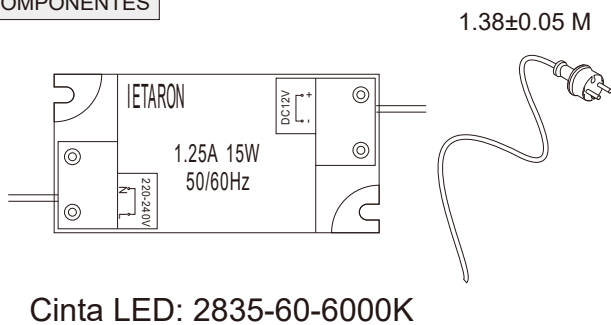

## Instrucciones de mantenimiento

1. Cuando utilice el espejo, no ponga productos químicos que incluyan ácido, alcalino y otros productos químicos corrosivos en el marco del espejo para que pueda evitar afectar a la superficie del espejo.
2. No ponga un gas volátil en el espejo.
3. No ponga la toalla húmeda o la toalla de baño en el armario, especialmente no toque el marco del espejo para que pueda evitarse la oxidación.
4. Cuando se utiliza el espejo durante mucho tiempo, después de que el espejo no es claro, podríamos utilizar la mezcla de 70 %  $C_2H_5OH$  y 30 % de agua para limpiar el espejo.
5. El lado del espejo se trata especialmente, por favor use un paño suave para limpiarlo, y mantenga el lado del espejo seco.

## HERRAMIENTAS



TALADRO ELÉCTRICO



REGLA



MARTILLO

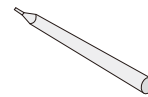

LÁPIZ



CINTA MÉTRICA

1. Coloque un soporte B de 250 en horizontal en la pared. Marque la posición del agujero y el borde.

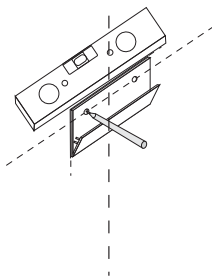

2. Perfore agujeros de  $\varnothing 8$  en 40 mm de profundidad en la posición de las 2 marcas, y ponga el tubo de expansión elástica dentro.

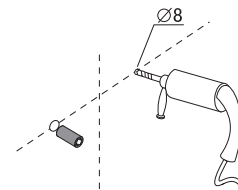

3. Como se muestra en la imagen, fije el soporte a la pared con tornillos.

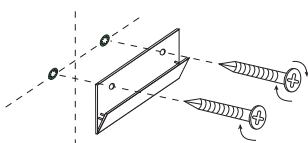

4. Coloque el espejo en la pared como un cuadro.

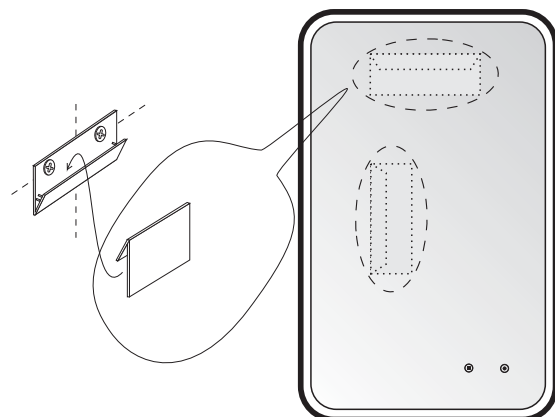

# Manuale di istruzioni di LIMORICO ML8673 (500\*800)

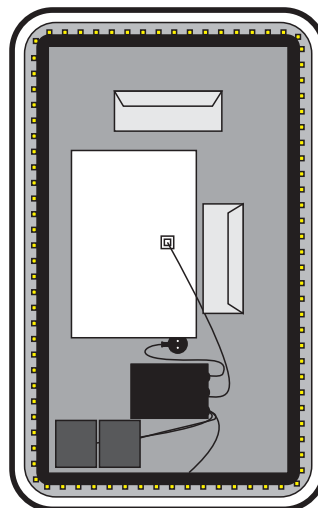

## COMPONENTI

1.38±0.05 M

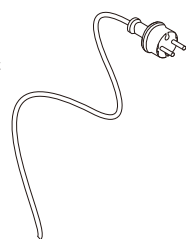
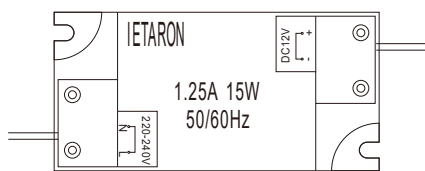

LED Cintura: 2835-60-6000K

## Istruzioni di manutenzione

1. Quando si utilizza lo specchio, non mettere le sostanze chimiche che includono acidi, alcalini e altre sostanze chimiche corrosive sul telaio dello specchio in modo da evitare di intaccare la superficie dello specchio.
2. Per favore, non mettere un po' di gas volatile nello specchio.
3. Si prega di non mettere l'asciugamano bagnato o l'asciugamano da bagno nell'armadio, in particolare non toccare la cornice dello specchio in modo da evitare l'ossidazione.
4. Quando si utilizza lo specchio per molto tempo, dopo che lo specchio non è chiaro, potremmo usarlo la Miscela di 70% C<sub>2</sub>H<sub>5</sub>OH e 30% di acqua per pulire lo specchio.
5. Il lato dello specchio è trattato in modo speciale, si prega di utilizzare un panno morbido per cancellarlo, e mantieni il lato dello specchio asciutto. Si prega di non usare prodotti chimici acidi per cancellarlo.

## STRUMENT



TRAPANO ELETTRICO



RIGA



MARTELLLO

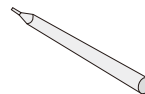

MATITA



METRO

1. Mettere una staffa B da 250 in orizzontale sul muro. Segnare la posizione del foro e del bordo.

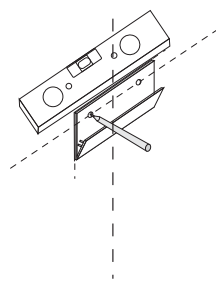

2. Praticare Ø8 in fori di profondità 40MM nella posizione dei 2 segni e inserire il tubo di espansione elastica all'interno.

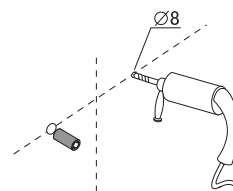

3. Come nell'immagine seguente, fissare la staffa sul muro con le viti.

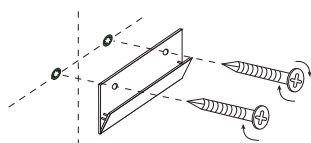

4. Metti lo specchio sul muro come immagine.

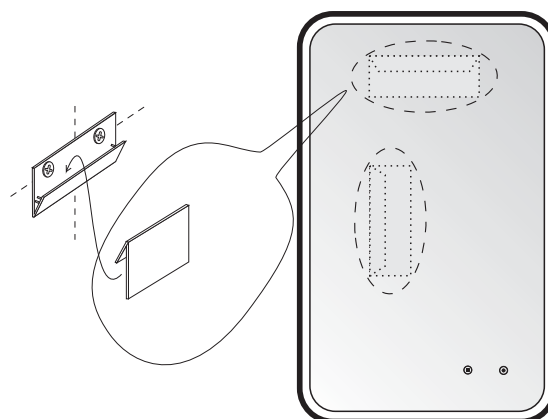

# Installatiehandleiding van of LIMORICO ML8673 (500\*800)

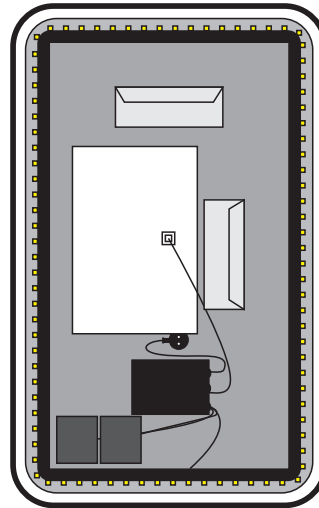

## COMPONENTEN

1.38±0.05 M

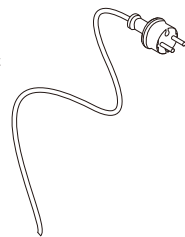
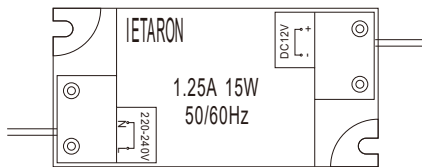

LED-riem: 2835-60-6000K

## Onderhoudsinstructie

1. Wanneer u de spiegel gebruikt, breng dan geen chemicaliën zoals zure, alkalische en andere bijtende chemicaliën aan op het frame van de spiegel, anders kan het oppervlak van de spiegel worden aangetast.
2. Stop geen vluchtige gassen in de spiegel.
3. Plaats geen natte handdoek of badhanddoek niet in het kabinet en raak vooral het frame van de spiegel niet aan, zodat oxidatie kan worden voorkomen.
4. Wanneer de spiegel langere tijd wordt gebruikt en niet meer helder is, kunt u een mengsel van 70% C<sub>2</sub>H<sub>5</sub>OH en 30% water gebruiken om de spiegel schoon te maken.
5. De zijkant van de spiegel is speciaal behandeld, gebruik een zachte doek om het te verwijderen en houd de zijkant van de spiegel droog. Gebruik geen zure chemicaliën om het te verwijderen.

## HULPMIDDELEN



ELEKTRISCHE BOOR



LINIAAL



HAMER

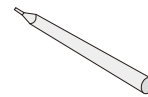

POTLOOD



ROLMAAT

1. Plaats een 250-beugel B horizontaal op de muur. Markeer de positie van het gat en de rand.

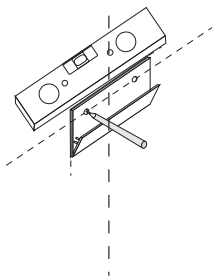

2. Boor Ø8 gaten met een diepte van 40 mm op de positie van de 2 markeringen en plaats de elastische expansiepijp erin.

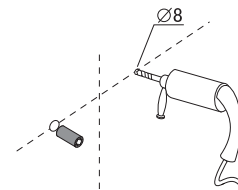

3. Bevestig de beugel aan de muur met schroeven zoals te zien in de afbeelding.

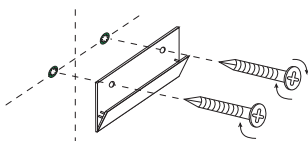

4. Plaats de spiegel op de muur zoals aangegeven in de afbeelding.

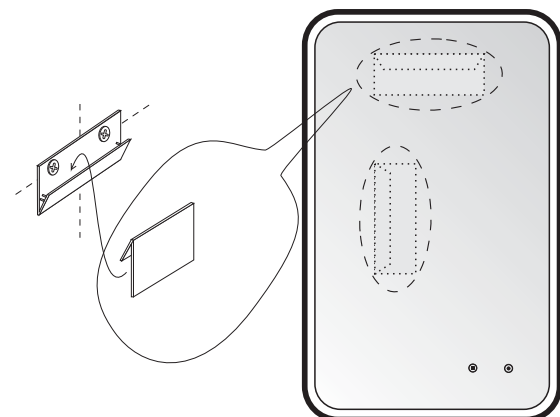

# Manual de instalação de LIMORICO ML8673 (500\*800)

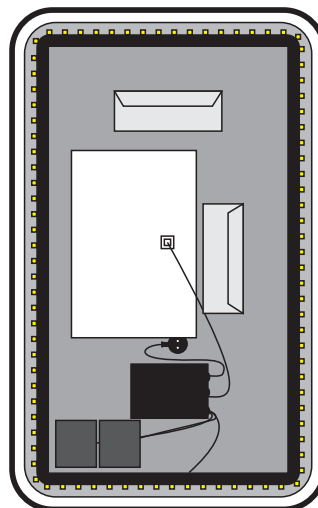

## COMPONENTES

1.38±0.05 M

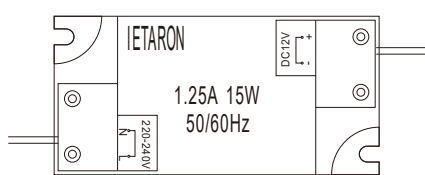

Correia LED: 2835-60-6000K

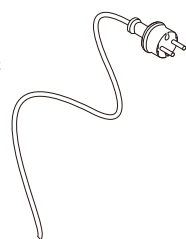

## Instruções de manutenção

1. Quando utiliza o espelho, não utilize químicos que incluam ácidos, produtos alcalinos ou outros químicos corrosivos na estrutura do espelho, pois poderão afetar a superfície do espelho.
2. Não coloque gás volátil no espelho.
3. Não coloque toalhas molhadas ou toalhas depois de utilizar no banho no armário, especialmente não toque na estrutura do espelho, para evitar o aparecimento de oxidação.
4. Quando utiliza o espelho durante um longo período, quando não estiver tão nítido, pode utilizar uma mistura álcool de de 70% (C<sub>2</sub>H<sub>5</sub>OH) e 30% de água para limpar o espelho.
5. O espelho é muito frágil, utilize um pano suave para limpar e mantenha as laterais do espelho secas. Não utilize químicos ácidos para limpar.

## FERRAMENTAS



BERBEQUIM



RÉGUA



MARTELO

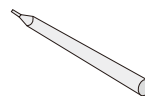

LÁPIS



FITA MÉTRICA

1. Coloque um Suporte B 250 na horizontal na parede. Marque a posição do orifício e da extremidade.

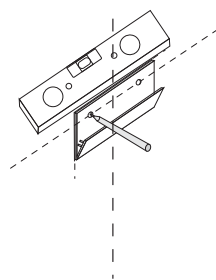

2. Faça furos com Ø8 e 40MM de profundidade na posição das 2 marcas e coloque a bucha expansora no interior.

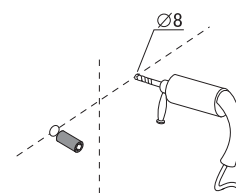

3. Conforme indicado de seguida, encaixe o suporte Bon na parede com parafusos.

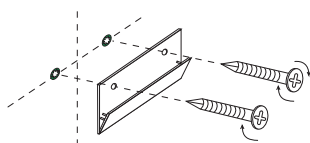

4. Coloque o espelho na parede, conforme ilustrado.

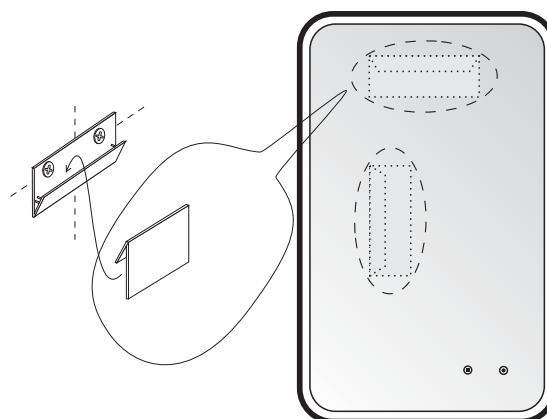



# Instrukcja montażu LIMORICO ML8673 (500\*800)

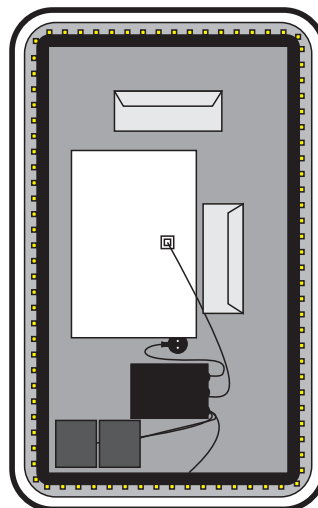

## CZĘŚCI SKŁADOWE

1.38±0.05 M

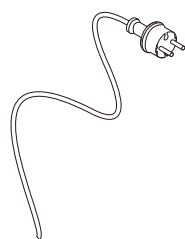
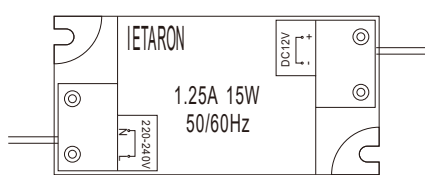

Taśma LED: 2835-60-6000K

## Instrukcja konserwacji

1. Użytkując lustro, nie należy nakładać na jego ramę żadnych substancji chemicznych, w tym kwasów, zasad i innych substancji żrących, aby nie uszkodzić powierzchni lustra.
2. Trzymaj lustro z dala od lotnych gazów.
3. Nie wkładaj mokrego ręcznika do szafki, zwłaszcza nie dotykaj ramy lusterka, aby uniknąć jego utlenienia.
4. Kiedy używasz lustro przez dłuższy czas, a lustro nie jest czyste, możesz użyć mieszaniny 70% C<sub>2</sub>H<sub>5</sub>OH(etanolu) i 30% wody do przetarcia lustra i przywrócenia jego czystości.
5. Strona lustra wymaga specjalnego czyszczenia, używaj miękkiej szmatki, aby ją wyczyścić i utrzymuj stronę lustra w suchości. Nie używaj kwaśnych środków chemicznych do czyszczenia lustra.

## NARZĘDZIA



WIERTARKA ELEKTRYCZNA



LINIAŁ



MŁOTEK

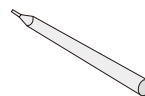

OŁÓWEK



TAŚMA MIERNICZA

1. Umieść wspornik-250 B w pozycji poziomej na ścianie. Zaznacz położenie otworu i krawędzi.

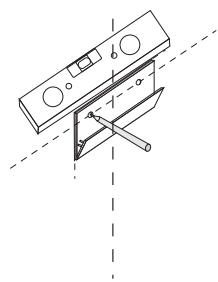

2. Wywierć otwory Ø8 o głębokości 40 mm w pozycji 2 znaków i wewnątrz umieść rurkę elastyczno-rozprężną.

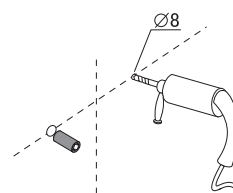

3. Jak pokazano na rysunku, śrubami przymocuj wspornik B do ściany.

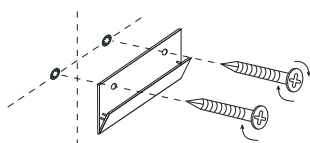

4. Umieść lustro na ścianie, jak to by był obraz.

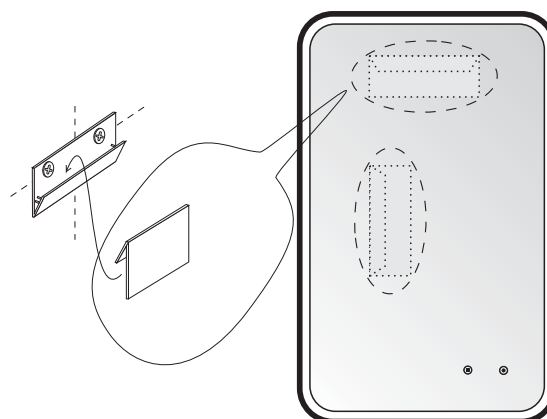

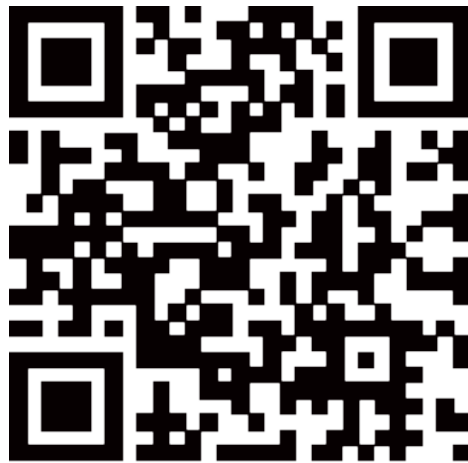

Vente-unique<sup>.com</sup>

VS-JUNE-2022

Imported by - Importé par  
VENTE-UNIQUE.COM  
9 Rue Jacquart 93310 Le Pré-Saint-Gervais  
Made in China/ Fabriqué en Chine