

# CHAMONIX

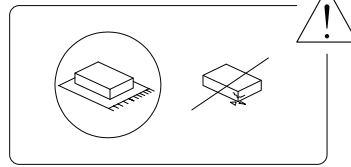

90°

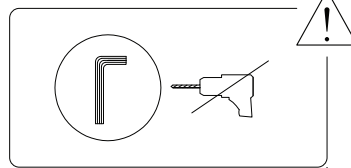

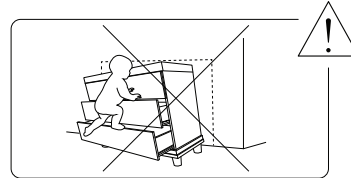
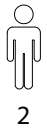





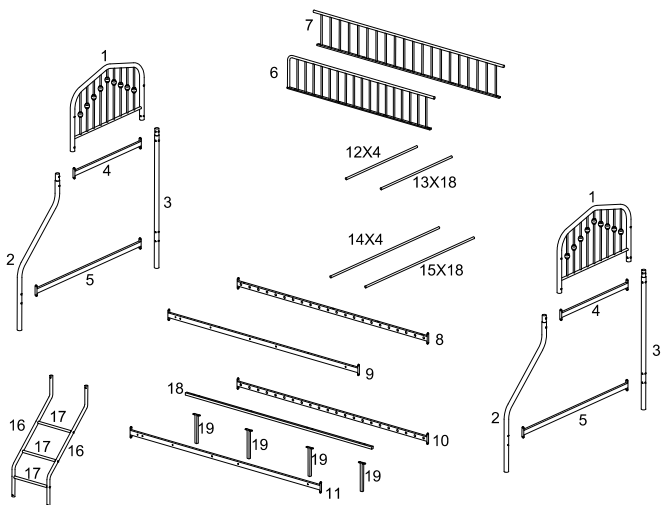





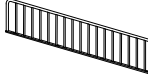
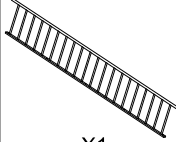
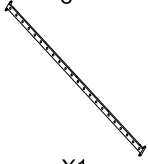

2

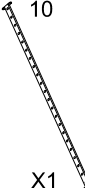
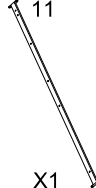
1/11















2496/BOULIN/060525/



2/11

1  X2	2  X2	3  X2	4  X2
5  X2	6  X1	7  X1	8  X1
9  X1	10  X1	11  X1	12  X4
13  X18	14  X4	15  X18	16  X2
17  X3	18  X1	19  X4	

3/11

<b>A</b>  x40	<b>B</b>  x10	<b>C</b>  x9	<b>D</b>  x3	<b>E</b>  x16
<b>F</b>  x21	<b>G</b>  x16	<b>H</b>  x33	<b>J</b>  x37	<b>M</b>  x2
<b>N</b>  x2	<b>O</b>  x4	<b>P</b>  x2	<b>Q</b>  x2	<b>Z</b>  x72

4/11

1X2

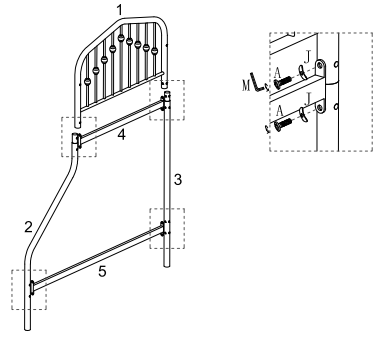
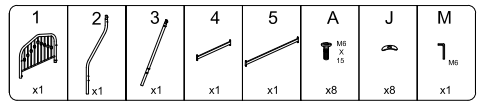

2X18

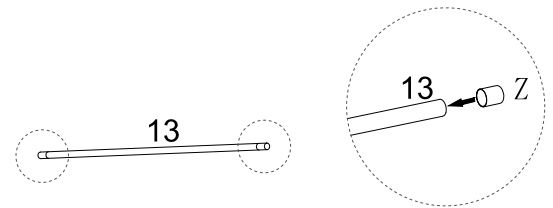
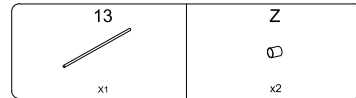

5/11

3

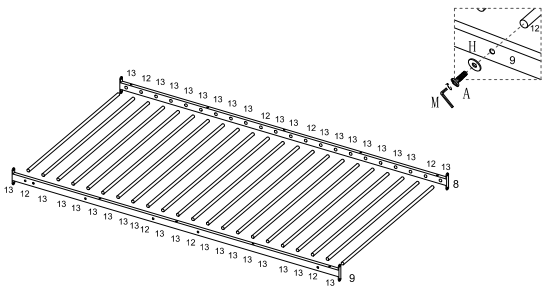
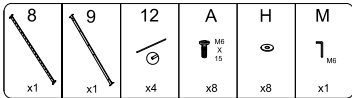

5

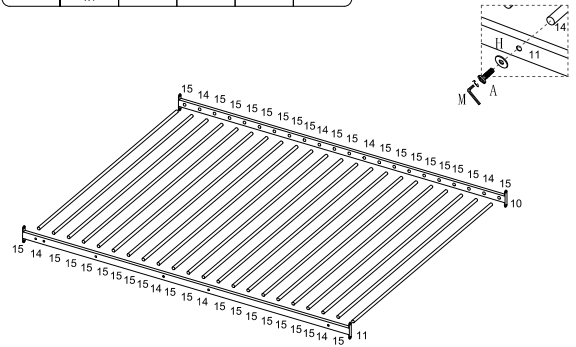
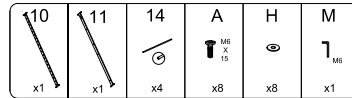

4X18

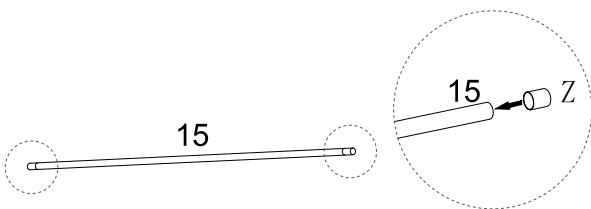
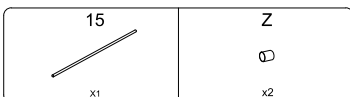

6/11

6

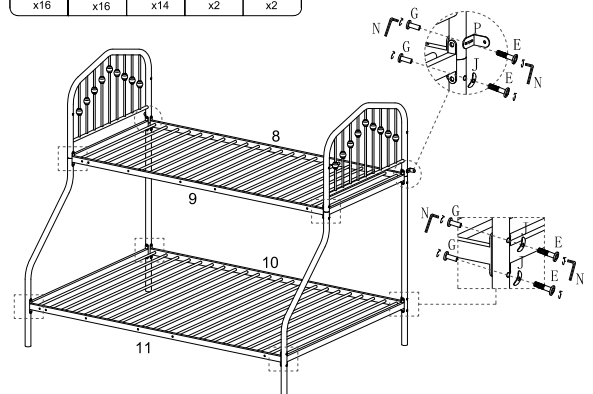
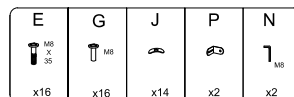

7/11

7

18 x1	19 x4	A M6 x 15 x8	F M6 x8	H x8	O x4	M M6 x2
----------	----------	--------------------	---------------	---------	---------	---------------

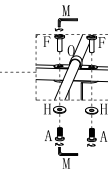
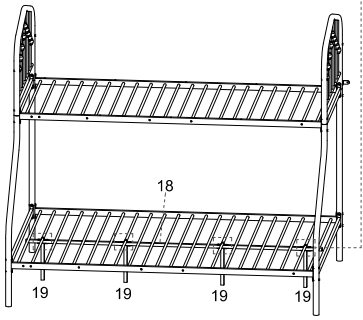

9

C M6 x 45 x9	F M6 x9	H x9	M M6 x2
--------------------	---------------	---------	---------------

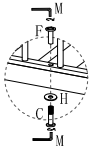

8

6 x1	7 x1	D M6 x 55 x3	J x3	M M6 x1
---------	---------	--------------------	---------	---------------

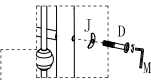
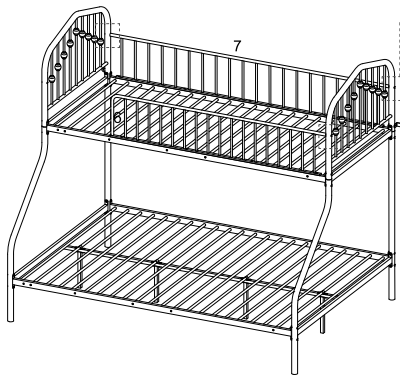

8/11

10

16 x2	17 x3	B M6 x 40 x6	M M6 x1
----------	----------	--------------------	---------------

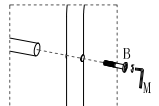
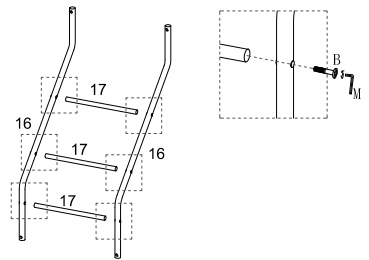

9/11

11

B M6 x 40 x4	J x4	F M6 x4	M M6 x2
--------------------	---------	---------------	---------------

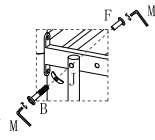

13



12

Q x2
---------

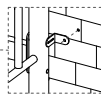

10/11

11/11