

FR Description du produit
EN Product description
ES Descripción del producto
DE Produktbeschreibung

IT Descrizione del prodotto
NL Productomschrijving
PT Descrição do produto

ANICET

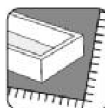
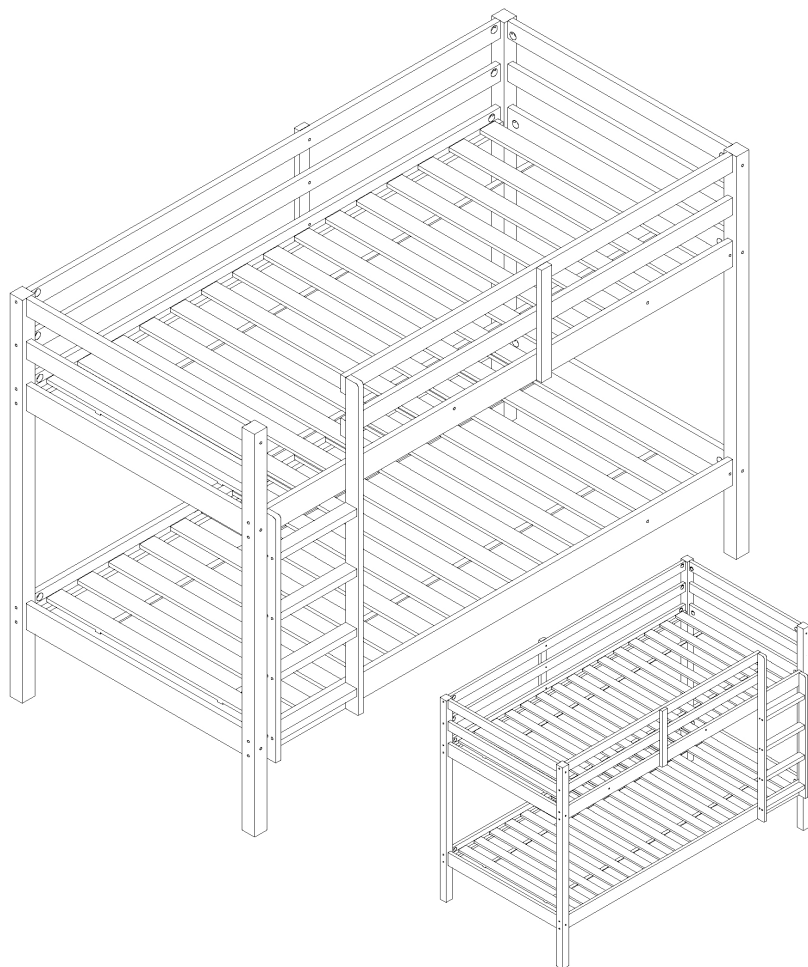

**VENTE-UNIQUE**
.com

**Meuble à usage domestique / Domestic furniture / Meuble a uso domestico / Möbel für den häuslichen Wohngebrauch/
Mobili per la casa/ Huishoudmeubilair / Mobiliário doméstico**

175497BLAN

3517920933594



1. Repérez les pièces constituant votre meuble.
2. Regroupez et comptez la quincaillerie.
3. Munissez-vous de l'outillage nécessaire.
4. Aménagez-vous une zone de montage, la moquette ou une couverture protégera des rayures.
5. Procédez au montage, ne jamais forcer sur les assemblages, resserrez les vis après quelques temps d'usage.



FR

Gardez votre notice de montage.

Si une pièce venait à manquer elle sera le moyen le plus clair pour communiquer avec votre magasin.
Nous conseillons d'aérer la pièce lors du montage et quelques heures après.

1. Identify the parts which make up your piece of furniture.
2. Gather the hardware parts and count them.
3. Have the necessary tools ready.
4. Organize a space for assembly, wall carpeting or a blanket will protect the furniture against scratches.
5. Mount the furniture, never force the parts to be assembled.



EN

Tighten the screws after it has been used for some time.

Keep the assembly instruction since it will help you when you get in touch with the store if a part should be missing.
We advise ventilating the room during installation and during few hours after.

1. Localice las piezas que componen su mueble.
2. Reagrupe y cuente la tornilleria.
3. Prepare las herramientas necesarias.
4. Prepare una zona de montaje, la moqueta o una manta protegerá de arañazos.
5. Proceda al montaje, no forzar sobre los embalages, apretar los tornillos después de algún tiempo de uso.



ES

Guardar las instrucciones de montaje.

Si una pieza le faltase, sera la manera mas facil de comunicarse con su proveedor.
Aconsejamos ventilar la zona durante la instalación y algunas horas después.

1. Bitte überprüfen Sie, ob alle Einzelteile Ihres Möbelstücks vorhanden sind.
2. Bitte überprüfen Sie, ob alle Schrauben und Verbindungsteile für die Montage vorhanden sind.
3. Halten sie alle notwendigen Montage-Werkzeuge für ihren Einsatz gebrauchsbereit.
4. Bereiten Sie einen passenden Ort für die Montage vor. Ein Teppichboden oder ähnliches schützt vor Kratzern.
5. Beginnen Sie mit der Montage. Lassen Sie sich Zeit und fügen Sie die Einzelteile nie mit Gewalt zusammen.



DE

Um einen langfristigen und einwandfreien Gebrauch zu gewährleisten, ziehen Sie die einzelnen Schrauben regelmäßig nach längerer Nutzung des Möbelstücks fest.

Bitte bewahren Sie diese Montageanleitung auf. Diese gewährleistet im Problemfall einen reibungslosen und schnellen Kommunikationsaustausch mit dem Kundenservice Ihres Geschäfts.

Wir beraten, lüften Sie den Raum während der Installation und ein paar Stunden später.

1. Identificare le parti che compongono il mobile.
2. Raccogliere le parti e contarle.
3. Tenere pronti gli attrezzi necessari.
4. Organizzare uno spazio per il montaggio, un telo da parete o una coperta proteggerà i mobili contro i graffi.
5. Montare il mobile, non forzare mai le parti da assemblare.



IT

Serrare le viti dopo che sono state usate per un certo periodo di tempo.
Conservare le istruzioni di montaggio poiché vi torneranno utili quando ricontatterete il negozio se una parte dovesse mancare.

Si consiglia di ventilare la stanza durante l'installazione e durante le ore successive.

1. Identificeer de onderdelen waar uw stuk meubilair uit bestaat.
2. Verzamel de hardwareonderdelen en tel deze.
3. Heb het vereiste gereedschap bijdehand.
4. Organiseer een ruimte voor assemblage; muurplijt of een deken zal het meubilair beschermen tegen krassen.
5. Monteer het meubilair en forceer hierbij nooit de te monteren onderdelen.



NL

Draai de schroeven vast nadat het een tijdje in gebruik is geweest.
Bewaars de assemblage-instructies in het geval dat u contact op moet nemen met de winkel indien er een onderdeel ontbreekt.

Wij raden u aan de kamer te ventileren tijdens en voor enkele uren na de installatie.

1. Identifique as peças que constituem a sua mobília.
2. Junte as ferragens e conte.
3. Tenha prontas as ferramentas necessárias.
4. Organize e arranje espaço para a montagem, colocando um tapete ou manta para proteger a mobília contra riscos.
5. Monte a mobília, nunca force as peças a montar.



PT

Aperte os parafusos após a peça de mobília ter sido utilizada durante algum tempo.
Guarde as instruções de montagem, pois serão úteis quando quiser contactar a loja, caso perca alguma peça.
Aconselhamos a ventilar a divisão durante a instalação e algumas horas depois.

INSTRUCTIONS D'UTILISATION

IMPORTANT - LIRE ATTENTIVEMENT- A CONSERVER POUR UNE REFERENCE ULTERIEURE

- a) AVERTISSEMENT "Les lits surélevés et le lit supérieur des lits superposés ne conviennent pas pour les enfants de moins de six ans en raison du risque de blessures liées à des chutes";
- b) AVERTISSEMENT "S'ils ne sont pas utilisés correctement, les lits superposés et les lits surélevés peuvent présenter un sérieux risque de blessure par étranglement. Ne jamais attacher ou suspendre des éléments à des parties du lit superposé qui ne sont pas destinés à être utilisés avec ledit lit. Ces éléments comprennent, sans toutefois, s'y limiter, les cordes, les ficelles, les cordons, les crochets, les ceintures et les sacs";
- c) AVERTISSEMENT "Les enfants peuvent se retrouver coincés entre le lit et un mur, une partie d'un toit incliné, le plafond, des meubles adjacents (par exemple, des placards) ou autre. Pour éviter tout risque de blessure grave, la distance entre la barrière de sécurité supérieure et les éléments environnants ne doit pas dépasser 75 mm ou doit être supérieure à 230 mm";
- d) AVERTISSEMENT "Ne pas utiliser le lit superposé ou le lit surélevé si une pièce de la structure est manquante ou cassée";
- e) AVERTISSEMENT "Risques de chute, faites attention en descendant de la plateforme.

- a) Toujours suivre les instructions du fabricant; Tout mauvais assemblage de la plateforme, différent des directives dans les instructions peut causer un danger.
- b) Taille recommandée pour le ou les matelas: 1900 × 900 × 130 mm
- c) Il est nécessaire de ventiler la pièce afin de maintenir un niveau peu élevé d'humidité et d'empêcher le développement de moisissure dans le lit et autour de celui-ci;
- d) Vérifier régulièrement que tous les éléments de fixation sont correctement serrés;
- e) Le lit est conforme aux Exigences de la norme: EN747-1:2012+A1:2015 & EN747-2:2012+A1:2015

INSTRUCTION FOR USE

IMPORTANT - READ CAREFULLY - RETAIN FOR FUTURE REFERENCE

- a) WARNING "High beds and the upper bed of bunk beds are not suitable for children under six years due to the risk of injury from falls";
- b) WARNING "Bunk beds and high beds can present a serious risk of injury from strangulation if not used correctly. Never attach or hang items to any part of the bunk bed that are not designed to be used with the bed, for example, but not limited to ropes, trings, cords, hooks, belts and bags";
- c) WARNING "Children can become trapped between the bed and the wall. a roof picth, the ceiling, adjoining piece of furniture (e.g. cupboards) and the like. To avoid risk of serious injury; the distance between the top safety barrier and the wall shall not exceed 75mm or shall be more than 230 mm";
- d) WARNING " Do not use the bunk bed/high bed if any structural part is broken or missing;
- e) WARNING" Risks of fall attention to downside form the platform
- f) Always follow the manufacturer's instructions; Any wrong assembly of the platform different from the instruction guideline may cause danger.
- g) Recommended size of the mattress(es): 1900 × 900 × 130 mm
- h) Ventilation of the room is necessary in order to keep the humidity low and to prevent mould in and around the bed;
- i) Check regularly that all assembly fastenings are properly tightened;
- j) The bed meets the requirements of the standard: EN747-1:2012+A1:2015 & N747-2:2012+A1:2015

INSTRUCCIONES DE USO

IMPORTANTE - LEER ATENTAMENTE - CONSERVAR PARA FUTURAS CONSULTAS

- a) ADVERTENCIA "Las camas altas y las partes superiores de las literas no son aptas para menores de seis años debido al riesgo de heridas por caídas";
- b) ADVERTENCIA "Las literas y las camas altas presentan un riesgo grave de heridas por estrangulamiento si no se utilizan correctamente". Nunca conecte ni cuelgue elementos a ninguna parte de la cama litera que no esté diseñada para utilizarse con la cama, por ejemplo, cuerdas, perchas, ganchos, cinturones y bolsos";
- c) ADVERTENCIA "Los niños pueden quedar atrapados entre la cama y la pared. Pueden atraparse los dedos con los muebles contiguos, el techo. etc (por ejemplo, armarios). Para evitar el riesgo de lesiones graves, la distancia entre la barrera de seguridad superior y la pared no deberá exceder de 75 mm o deberá ser superior a 230 mm ";
- d) ADVERTENCIA "No utilice la cama alta/litera si alguna parte estructural está rota o falta;
- e) ADVERTENCIA " Riesgos Pérdida de Atención para Formar Manera Incorrecta de la plataforma.
- f) Siga siempre las instrucciones del fabricante; Cualquier montaje incorrecto de la plataforma distinto al de

las instrucciones puede provocar peligro.

g) Tamaño recomendado del colchón(es): $1900 \times 900 \times 130$ mm

h) Es necesario ventilar la habitación para mantener la humedad baja y para evitar el moho en y alrededor de la cama;

I) Compruebe con regularidad que todos los cierres de montaje estén bien apretados;

J) Cumpla con los requisitos de seguridad indicados: EN747-1:2012+A1:2015 & EN747-2:2012+A1:2015

BEDIENUNGSANLEITUNG

WICHTIG - SORGFÄLTIG LESEN - FÜR SPÄTERES NACHSCHLAGEN AUFBEWAHREN

a) WARNUNG "Hochbetten und das obere Bett von Stockbetten sind für Kinder unter sechs Jahren aufgrund des Verletzungsrisikos durch Herunterfallen nicht geeignet";

b) WARNUNG "Stock- und Hochbetten können ein ernsthaftes Verletzungsrisiko durch Strangulation darstellen, wenn sie nicht richtig benutzt werden. Hängen Sie niemals Gegensätend an irgendeinen Teil des Stockbetts, die dafür nicht konzipiert wurden, zum Beispiel Seile, Schnüre, Kordeln, Haken, Gürtel und Taschen";

c) WARNUNG "Kinder können zwischen Bett und Wand, Dach, Decke, naheliegende Möbelstücke (z.B. Schränke) und ähnlichem eingeklemmt werden. Um ernsthafte Verletzungen zu vermeiden, sollte der Abstand zwischen der oberen Sicherheitsbarriere und der Wand nicht größer als 75 mm oder größer als 230 mm sein";

d) WARNUNG " Verwenden Sie das Stockbett nicht, wenn Bauteile fehlen oder defekt sind;

e) WARNUNG " Beachten Sie die Sturzgefahr an der Plattform.

f) Befolgen Sie immer die Anweisungen des Herstellers; Falsche Montage der Plattform, die von der Bedienungsanleitung abweicht, kann Gefahren verursachen.

g) Empfohlene Matratzengröße(n): $1900 \times 900 \times 130$ mm

a) Belüftung des Raums ist erforderlich, um die Luftfeuchtigkeit niedrig zu halten und Schimmelbildung in und um das Bett zu vermeiden;

b) Prüfen Sie regelmäßig, ob alle Befestigungen festgezogen sind;

c) Stimmt mit den Sicherheitsanforderungen der Norm überein: EN747-1:2012+A1:2015 & EN747-2:2012+A1:2015

ISTRUZIONI PER L'USO

IMPORTANTE - LEGGERE CON ATTENZIONE - CONSERVARE PER RIFERIMENTO FUTURO

a) ATTENZIONE "I letti alti e il letto superiore del letto a castello non sono adatti ai bambini sotto i sei anni a causa del rischio di lesioni da caduta";

b) WARNING "Letti a castello e letti alti possono presentare un grave rischio di lesioni da strangolamento se non utilizzati correttamente. Non attaccare o appendere elementi a qualsiasi parte del letto a castello a meno che non siano progettati per essere utilizzati con il letto, per esempio, ma non solo, corde, spaghi, cavi, ganci, cinture e borse";

c) WARNING "I bambini possono rimanere intrappolati tra il letto e la parete, una pendenza del tetto, il soffitto, un mobile adiacente (ad esempio armadietti) e simili. Per evitare il rischio di lesioni gravi la distanza tra la barriera di sicurezza superiore e la parete non deve superare 75mm e deve essere maggiore di 230mm";

d) AVVERTENZA "Non usare il letto a castello/letto alto se una qualche parte strutturale è rotta o mancante;

e) AVVERTENZA Rischio di caduta. Attenzione alla forma inferiore la piattaforma

f) Seguire sempre le istruzioni del produttore; Qualsiasi errato montaggio della piattaforma diverso dalla linea guida riportata nelle istruzioni può essere causa di pericolo.

g) Dimensione consigliata del materasso/i: $1900 \times 900 \times 130$ mm

h) La ventilazione della camera è necessaria per mantenere bassa l'umidità e per impedire che si formi la

- a) muffa nel letto o intorno a esso;
- b) Controllare regolarmente che tutti i bloccaggi di montaggio siano serrati correttamente;
- c) Soddisfare i requisiti di EN747-1:2012+A1:2015 & EN747-2:2012+A1:2015.

GEbruIKSAANWIJZINGEN

BELANGRIJK - ZORGVULDIG LEZEN - BEWAAR ALS EVENTUEEL NASLAGWERK

- a) WAARSCHUWING "Hoogslapers en het bovenste bed van stapelbedden zijn ongeschikt voor kinderen jonger dan zes jaar wegens het risico op letsel door te vallen";
- b) WAARSCHUWING "Stapelbedden en hoogslapers kunnen een serieus risico op letsel door verstikking vormen wanneer incorrect gebruikt. Bevestig of hang geen voorwerpen aan een willekeurig deel van het stapelbed die niet zijn ontworpen voor gebruik met het bed, zoals, maar niet beperkt tot, touwen, snoeren, haken, riemen en tassen";
- c) WAARSCHUWING "Kinderen kunnen knel komen te zitten tussen het bed en de muur, een vloering, het plafond, aangrenzend meubilair (zoals een kabinet) en dergelijke. Om het risico op ernstig letsel te voorkomen, dient de afstand tussen de bovenste veiligheidsbalk en de muur niet minder dan 75mm te zijn of dient meer dan 230mm te zijn";
- d) WAARSCHUWING " Gebruik het stapelbed/de hoogslaper niet als enigerlei structureel onderdeel ontbreekt of gebroken is;
- e) WAARSCHUWING: Risico op vallen van het platform
- f) Volg altijd de instructies van de klant; Enigerlei verkeerde assemblage van het platform in tegenstrijd met de instructies kan tot gevaarlijke situaties leiden.
- g) Aanbevolen afmeting voor het matras/de matrassen: 1900 x 900 x 130mm
- h) Ventilatie van de kamer is vereist om de vochtigheidsgraad laag te houden en schimmelvorming in en rondom het bed te voorkomen;
- i) Controleer regelmatig dat alle bevestigingen goed vast zitten;
- j) Conform de vereisten van EN747-1:2012+A1:2015 & EN747-2:2012+A1:2015.

INSTRUCOES DE UTILIZACAO

IMPORTANTE - LER ATENTAMENTE - GUARDAR PARA REFERÊNCIA FUTURA

- a) AVISO "Camas altas e a cama superior dos beliches não são indicadas para crianças com menos de seis anos de idade devido ao risco de lesão por queda";
- b) AVISO "Os beliches e as camas altas podem representar um risco grave de lesão por estrangulamento se não forem utilizados corretamente. Nunca fixe nem pendure qualquer item em qualquer parte do beliche que não tenha sido concebido para ser utilizado com a cama, por exemplo, entre outros, cordas, fios, cordões, ganchos, cintos e malas";
- c) AVISO "As crianças podem ficar presas entre a cama e a parede, a inclinação do telhado, o teto, um móvel adjacente (p. ex., armários) entre outros. Para evitar o risco de lesão grave, a distância entre a barreira de segurança superior e a parede não deve exceder 75 mm nem deve ter mais do que 230 mm";
- d) AVISO " Não utilize o beliche/cama alta se alguma peça estrutural estiver partida ou em falta;
- e) AVISO" Riscos De queda, atenção à parte inferior a partir da plataforma
- f) Siga sempre as instruções do fabricante; Qualquer montagem indevida da plataforma diferente das instruções pode provocar uma situação de perigo.
- g) Tamanho recomendado do(s) colchão(ões): 1900 x 900 x 130mm
- h) É necessária ventilação no quarto para manter o nível de humidade baixo e evitar o aparecimento de bolor na cama e em torno da mesma;
- i) Verifique regularmente se todas as fixações do conjunto estão devidamente apertadas;
- j) Cumpra o requisito das normas EN747-1:2012+A1:2015 e EN747-2:2012+A1:2015.

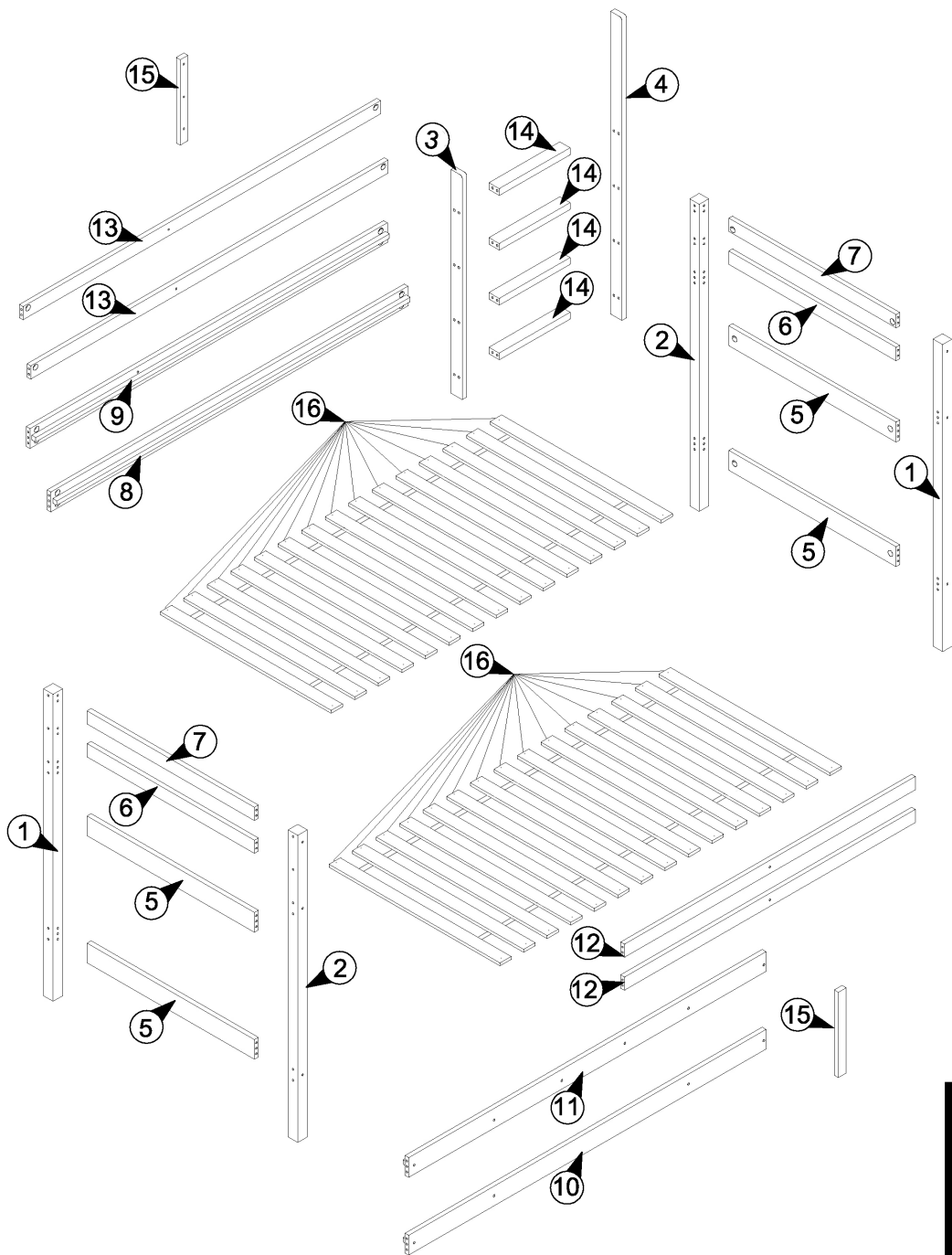



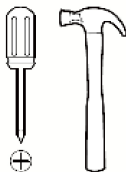









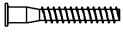

TOOLS

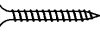

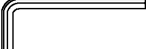
No.	Size	Qty	Ctn no
1	1400*50*50mm	2	1/2
2	1400*50*50mm	2	1/2
3	920*60*20mm	1	1/2
4	1190*60*20mm	1	1/2
5	870*90*20mm	4	1/2
6	870*60*20mm	2	1/2
7	870*60*20mm	2	1/2
8	1880*90*20mm	1	1/2
9	1880*90*20mm	1	1/2
10	1880*90*20mm	1	1/2
11	1880*90*20mm	1	1/2
12	1510*60*20mm	2	1/2
13	1880*60*20mm	2	1/2
14	350*50*23mm	4	1/2
15	340*40*20mm	2	1/2
16	900*60*13mm	30	2/2



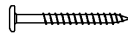



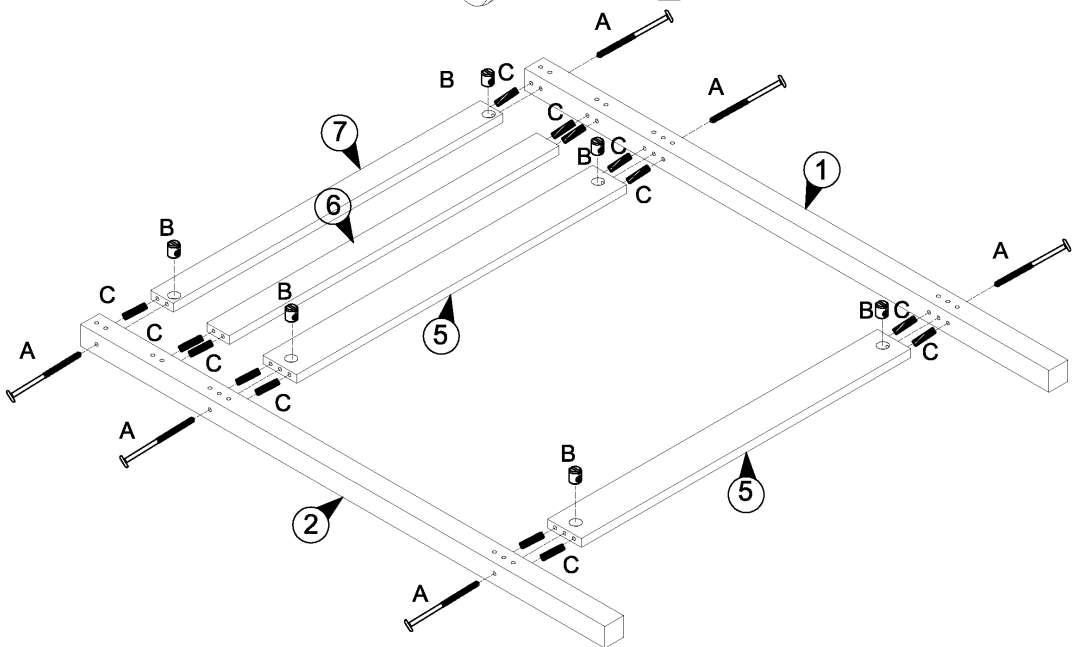
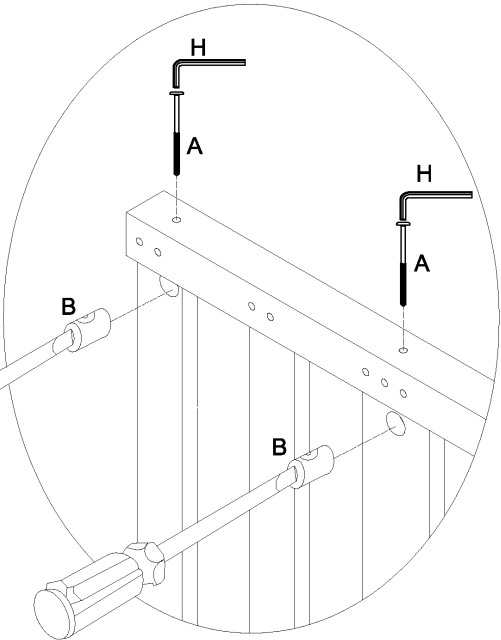
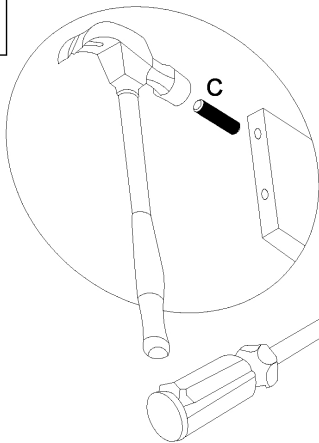

Hardware Ctn No.

1

A	X34	B	X34	C	X42	D	X16	
								
M6×90mm		M6		Ø8x30mm		Ø7×60mm		
E	X60	F	X13	G	X36	H		X01
								
Ø4x30mm		M6		M15				
I	X06	J	X06	K	X02	L		X02
								
M6×30mm		M6×70mm				Ø4x30mm		

1









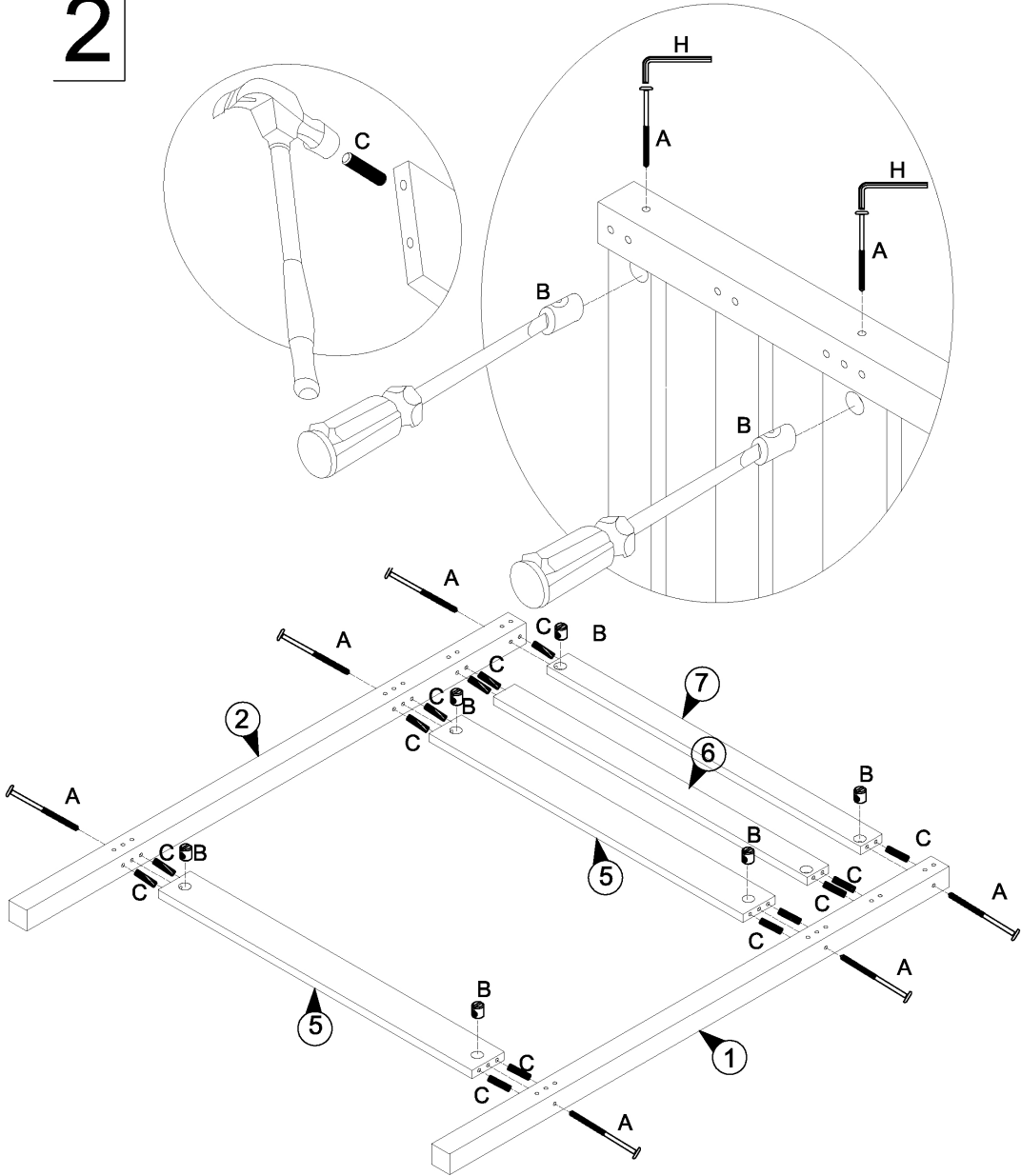

A	X06	B	X06	C	X14	H	X01
							
M6×90mm		M6		Ø8x30mm			

2





9

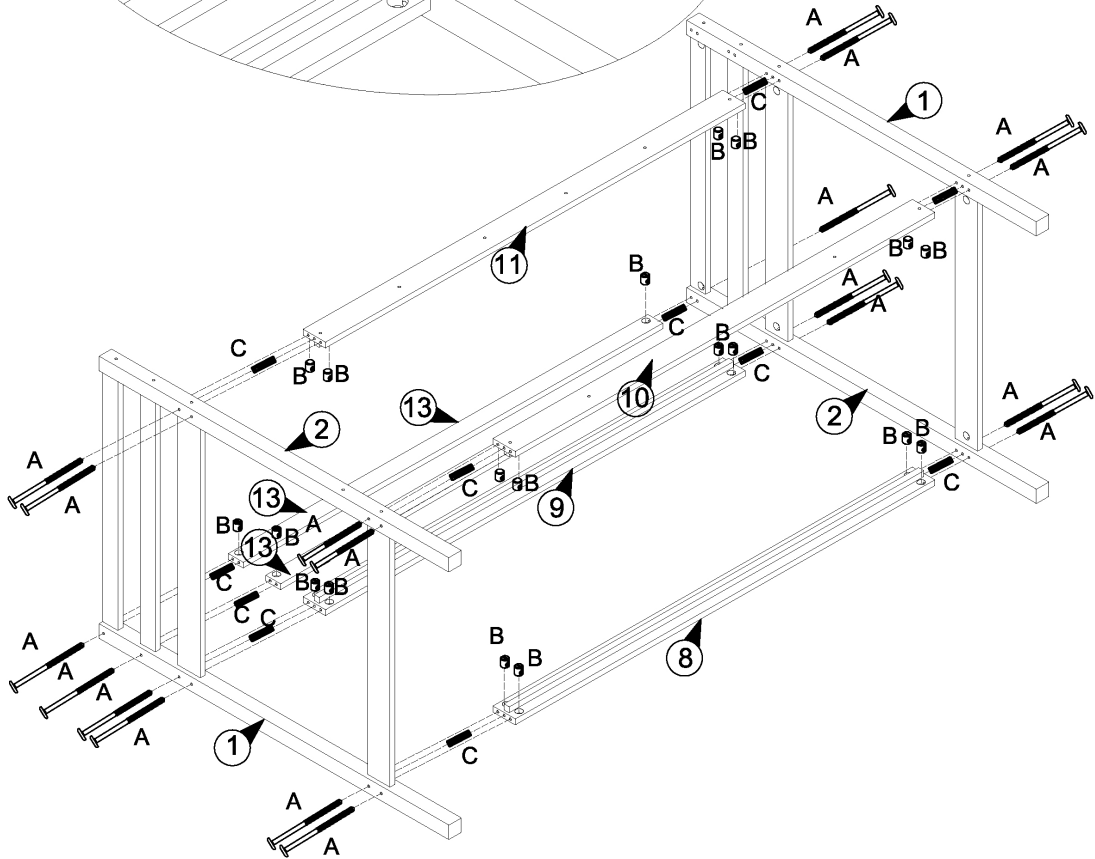
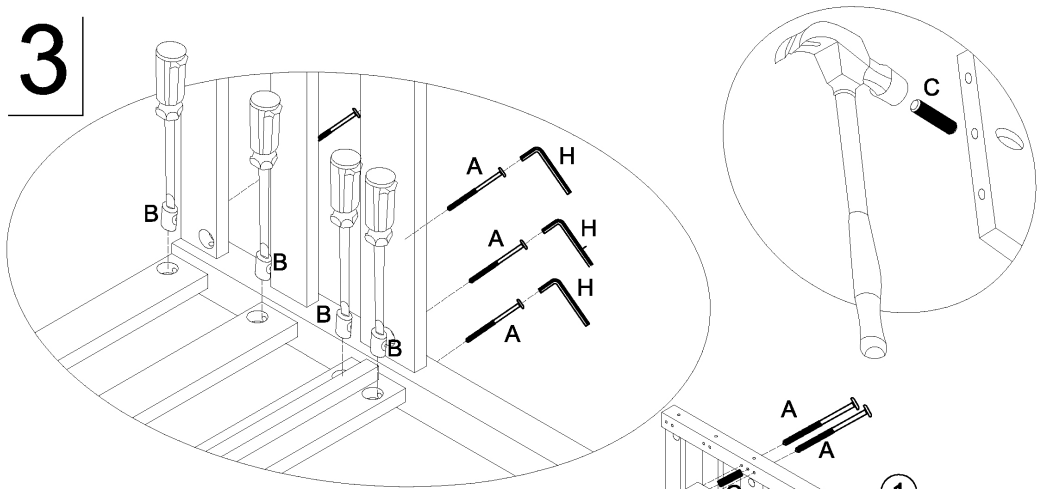

A	X06	B	X06	C	X14	H	X01
							
M6×90mm		M6		Ø8x30mm			

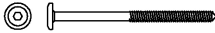



3

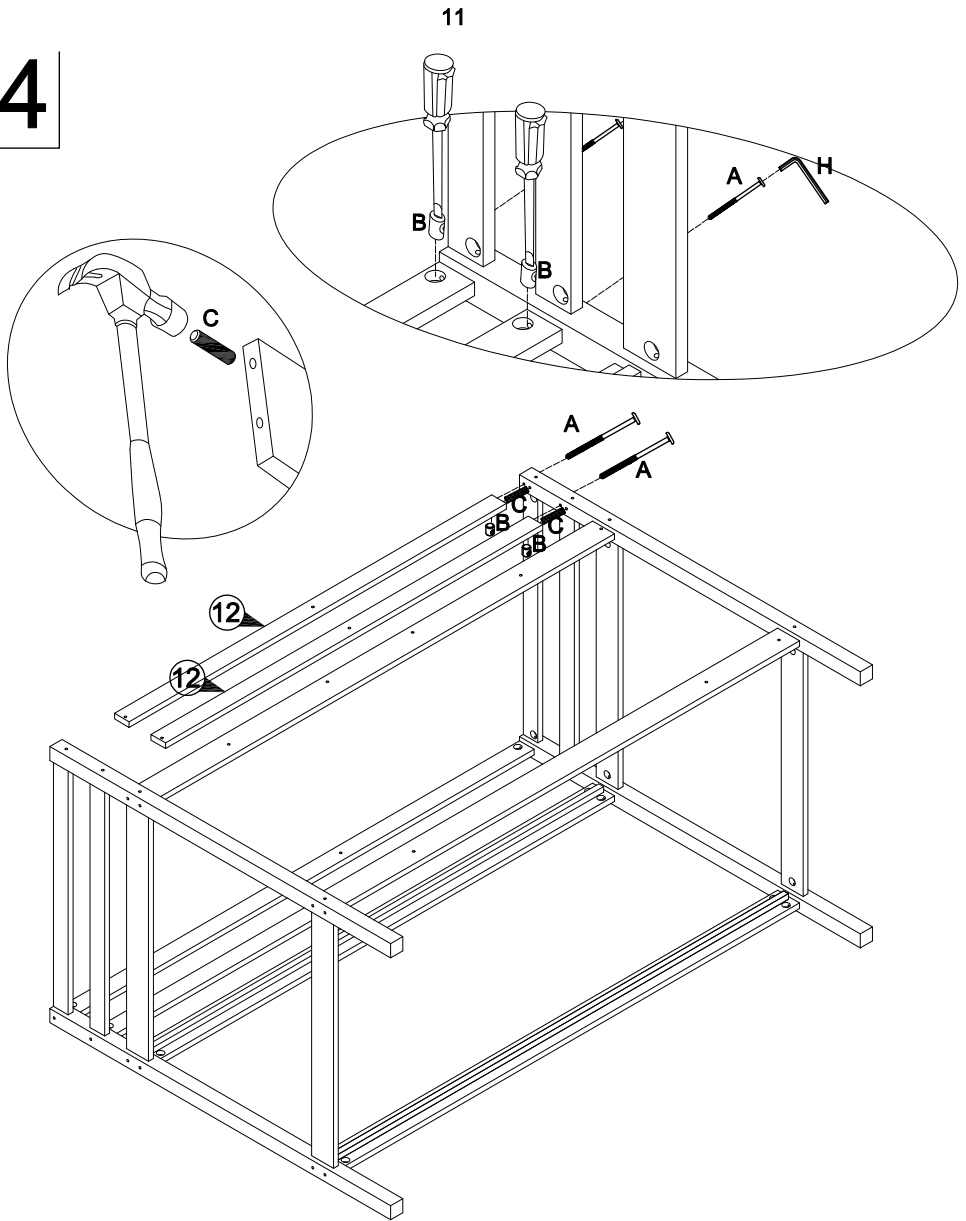

A	X20	B	X20	C	X12	H	X01
							
M6×90mm		M6		Ø8x30mm			

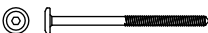

4





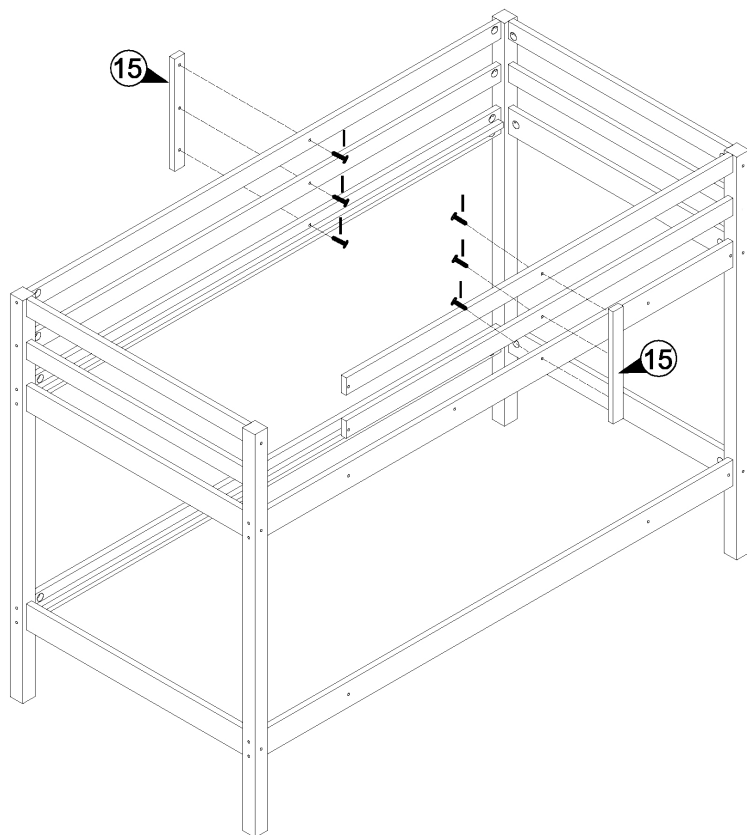

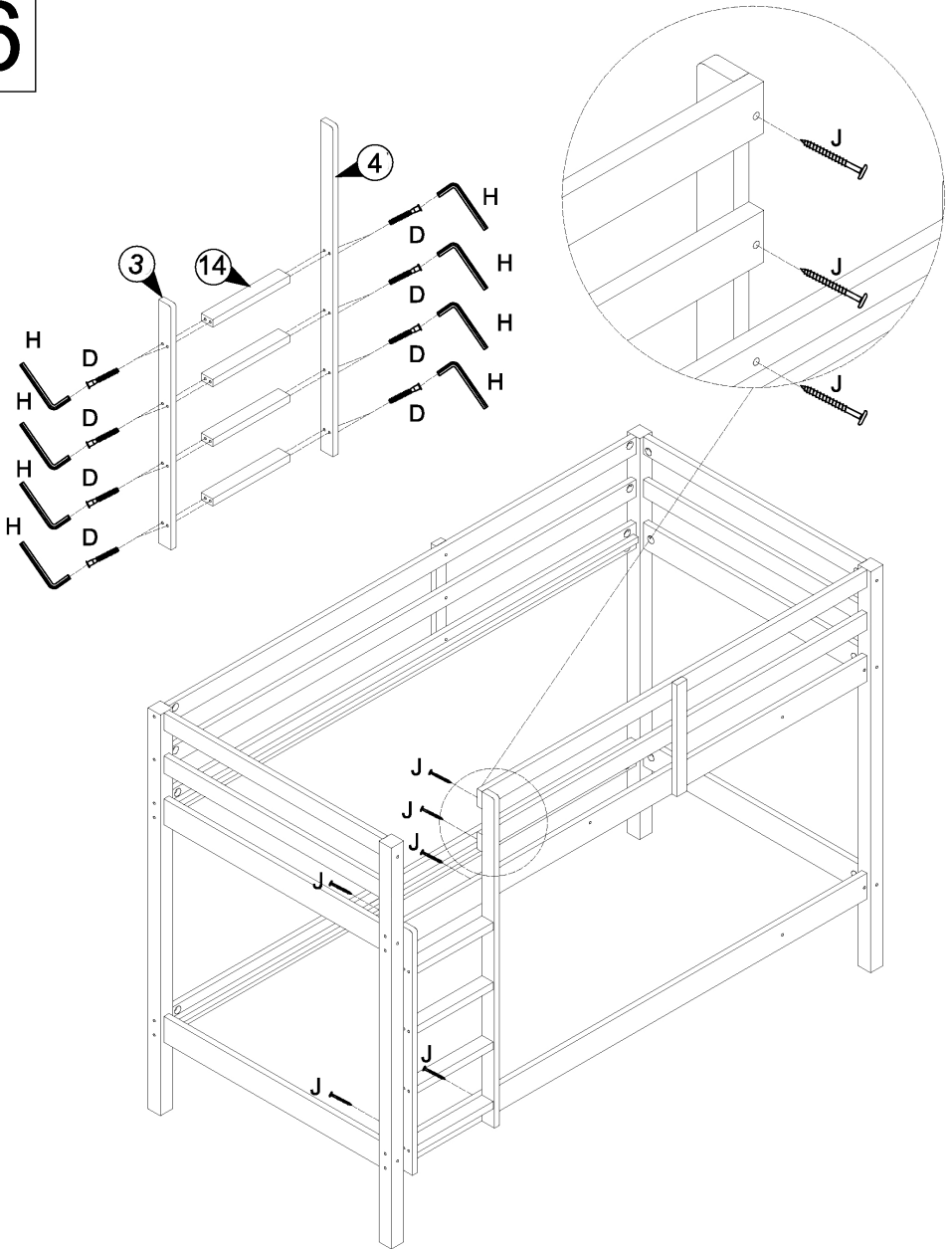

A	X02	B	X02	C	X02	H	X01
							
M6×90mm		M6		Ø8x30mm			

5

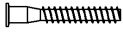

I	X06	H	X01
			
M6×30mm			

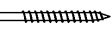

D	X16	J	X06	H	X01
					
Ø7×60mm		M6×70mm			

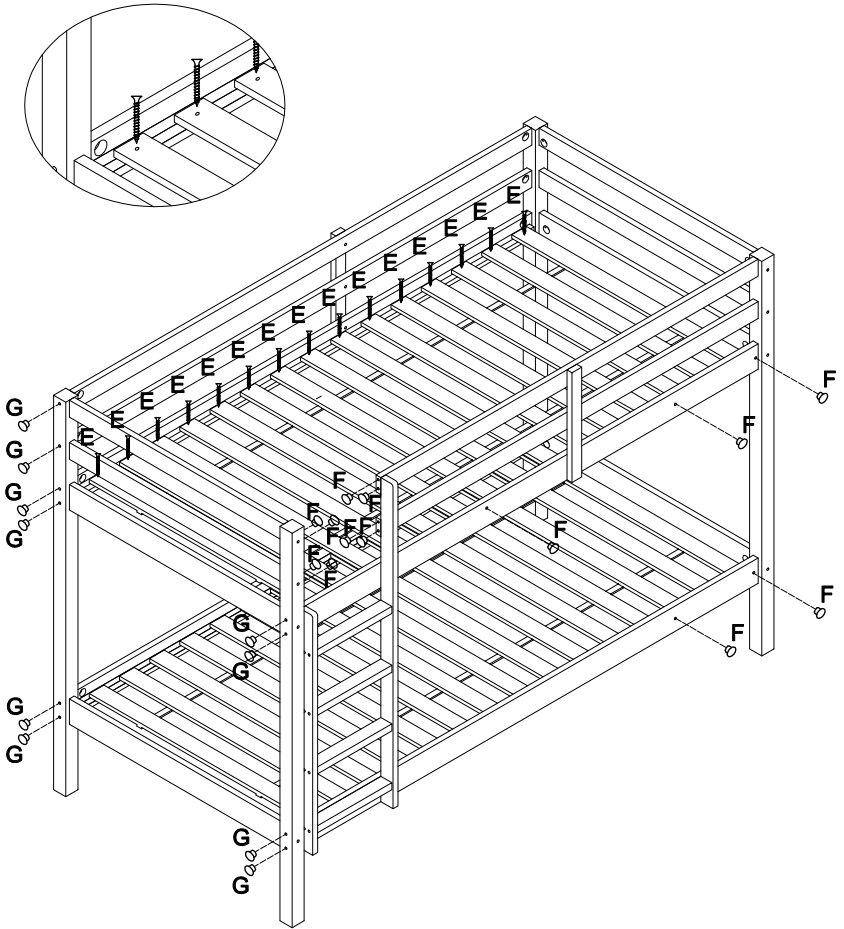

E	X60	F	X13	G	X36
					
Ø4x30mm		M6mm		M15mm	

8

15

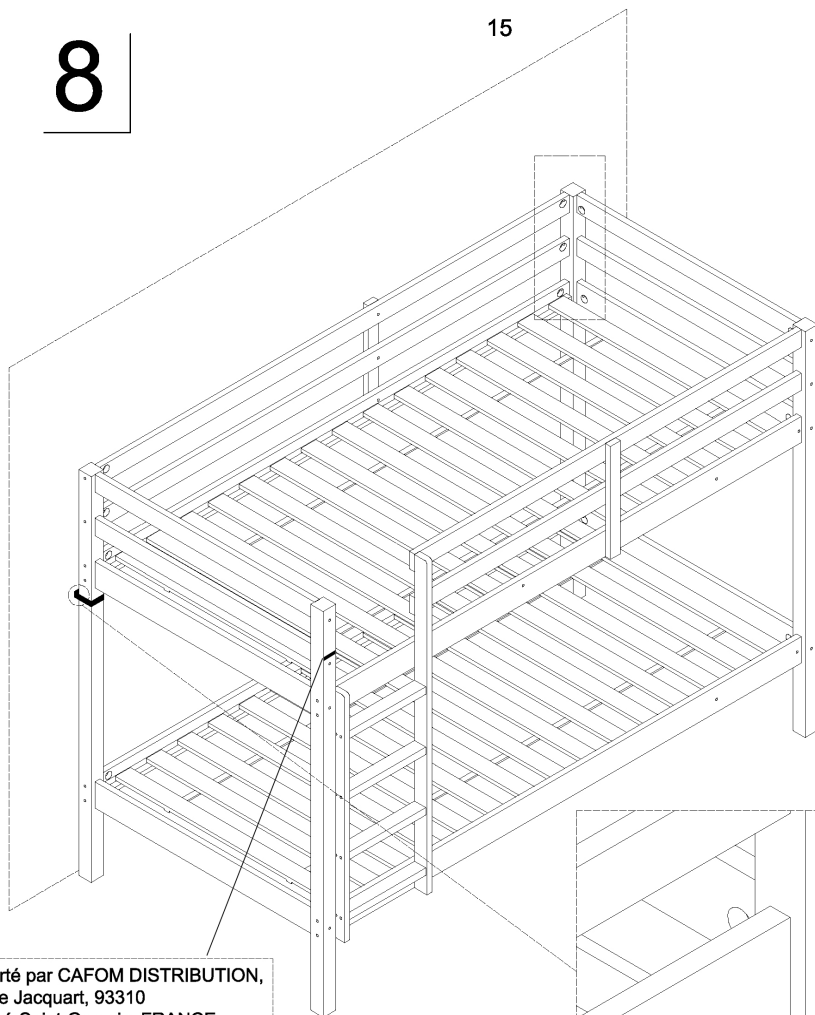



Importé par CAFOM DISTRIBUTION,
9 Rue Jacquart, 93310
Le Pré-Saint-Gervais, FRANCE.
Ref : ANICET/B1213
N° lot :
Conforme aux exigences de sécurité
NF EN 747-1&2:2012+A1:2015

Le couchage supérieur ne convient
pas pour les enfants de moins de 6
ans.

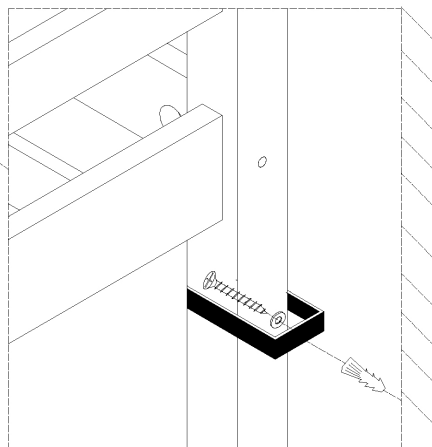
Hauteur maximum du matelas



K	X02	L	X04
			
		Ø4x50mm	

Entretien et maintenance:

Dépoussiérer régulièrement avec un chiffon sec.

Nettoyer avec du liquide vaisselle et essuyer avec un chiffon humide.

Ne pas utiliser le produit si l'un des éléments semble endommagé, brisé ou manque.

Éviter de placer ce produit à proximité de feu ouvert et d'autres sources de forte chaleur telle qu'un radiateur.

Care and maintenance:

Remove dust regularly with a dry cloth.

Clean with dishwashing liquid and wipe with a damp cloth.

Do not use the product if any part appears damaged, broken or missing.

Be aware of the risk of open fire and other sources of strong heat, such as electric heaters, in the vicinity of the product.

Cuidado y mantenimiento:

Quite el polvo periódicamente con un paño seco.

Limpiar con líquido para lavar platos y limpie con un paño húmedo.

No utilice el producto si alguna de las piezas está dañada, rota o falta.

Conozca los riesgos de un fuego y de otras fuentes de calor fuerte, como los calefactores eléctricos, en las proximidades del producto.

Pflege und Wartung:

Entfernen Sie den Staub regelmäßig mit einem trockenen Tuch.

Reinigen Sie mit Spülmittel und wischen Sie mit einem feuchten Tuch.

Verwenden Sie das Produkt nicht, wenn Teile beschädigt, defekt sind oder fehlen.

Achten Sie auf die Gefahr von Feuer und anderen starken Wärmequellen in der Nähe des Produkts, wie elektrische Heizkörper.

Cura e manutenzione:

Rimuovere la polvere regolarmente con un panno asciutto.

Pulire con detersivo per piatti e asciugare con un panno umido.

Non utilizzare il prodotto se una parte risulta danneggiata, rotta o mancante.

Essere consapevoli del rischio rappresentato da un camino e da altre fonti di forte calore, come riscaldatori elettrici, in prossimità del prodotto.

Onderhoud en reiniging:

Verwijder regelmatig enigerlei stof met een droge doek.

Reinig met afwasmiddel en veeg af met een vochtig doekje.

Gebruik het product niet als enigerlei onderdelen beschadigd lijken, gebroken zijn of ontbreken.

Houd rekening met de risico's van open vuur en andere krachtige hittebronnen, zoals elektrische verwarmingen, in de buurt van het product.

Cuidado e manutenção:

Remova frequentemente a poeira com um pano seco.

Limpe com detergente da loiça e um pano humedecido.

Não utilize o produto se alguma peça parecer danificada, partida ou em falta.

Tenha em atenção o risco de chama viva e de outras fontes de calor forte, como aquecedores elétricos, perto do produto.



VS-Jul-2017

Imported by - Importé par

CAFOM DISTRIBUTION

9 Rue Jacquart 93310 Le Pré-Saint-Gervais

Made in China/ Fabriqué en Chine