

Bella  
bing

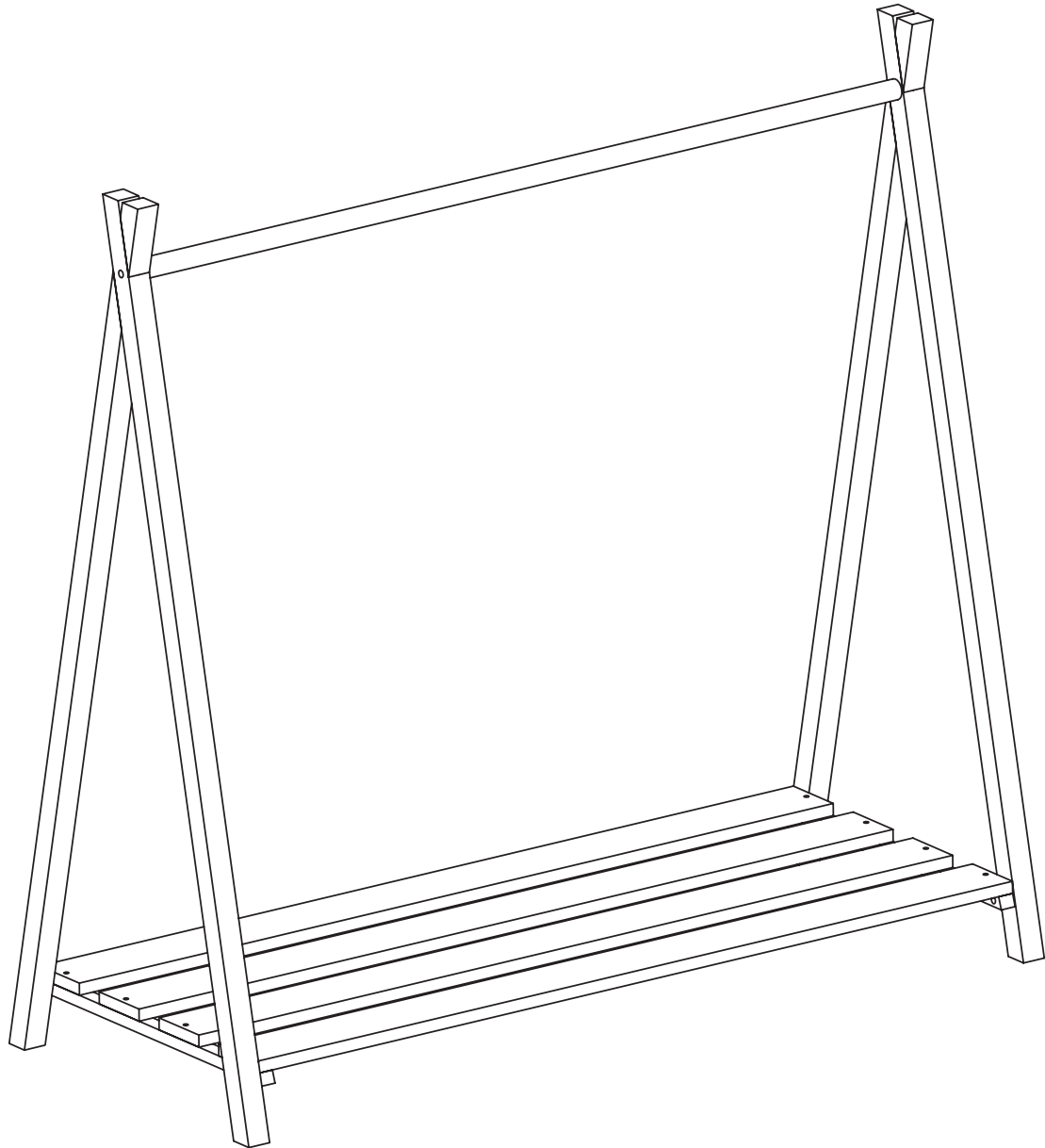

**Ryck**  
Kleiderstange

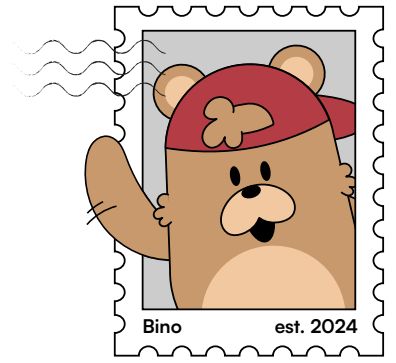
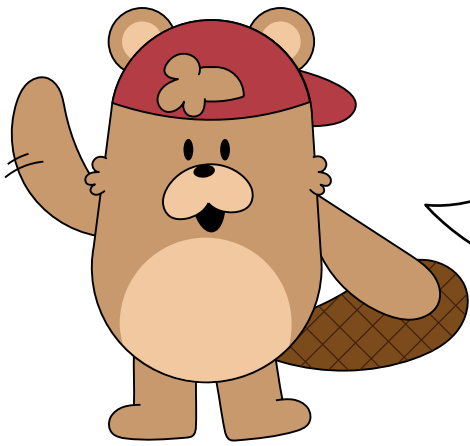

# Hey,

ich freue mich, dass Du Dich für mein Produkt entschieden hast. Beachte die kommenden Hinweise, um den Aufbau problemlos zu gestalten.

**Viel Spaß mit Deinem Produkt!**

# 50%

weniger Fehler beim Aufbau durch sorgfältiges Lesen der Anleitung

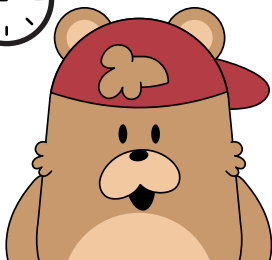
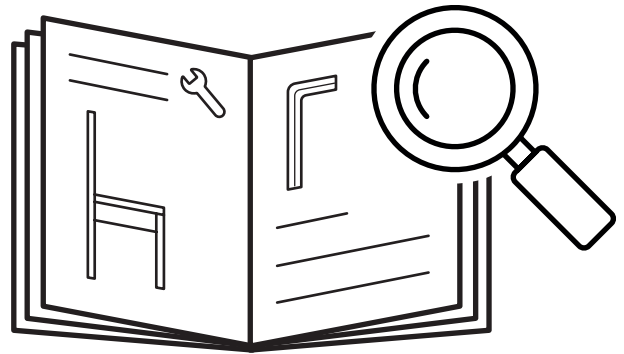

# 15-20

min



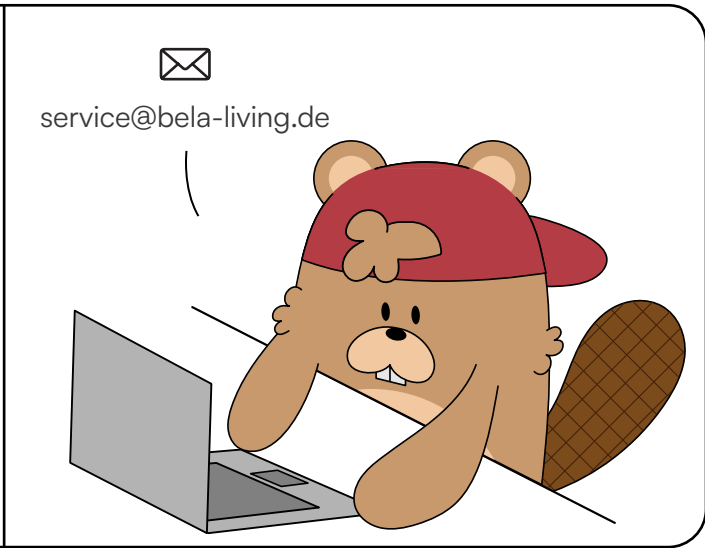
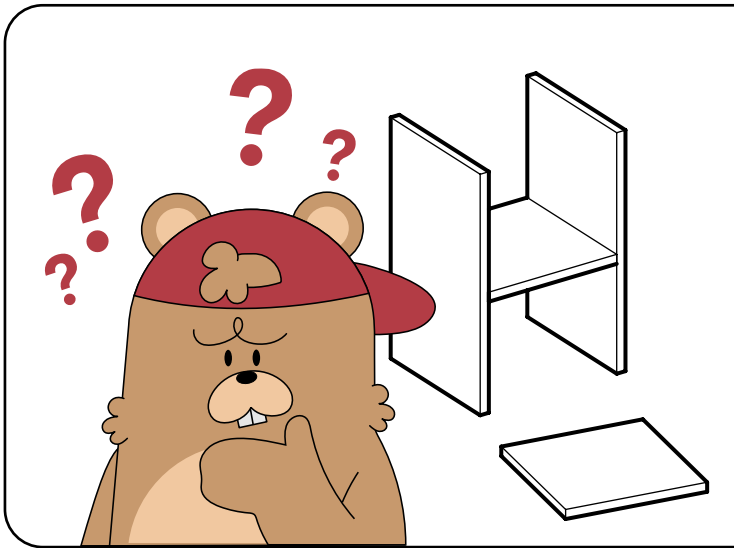
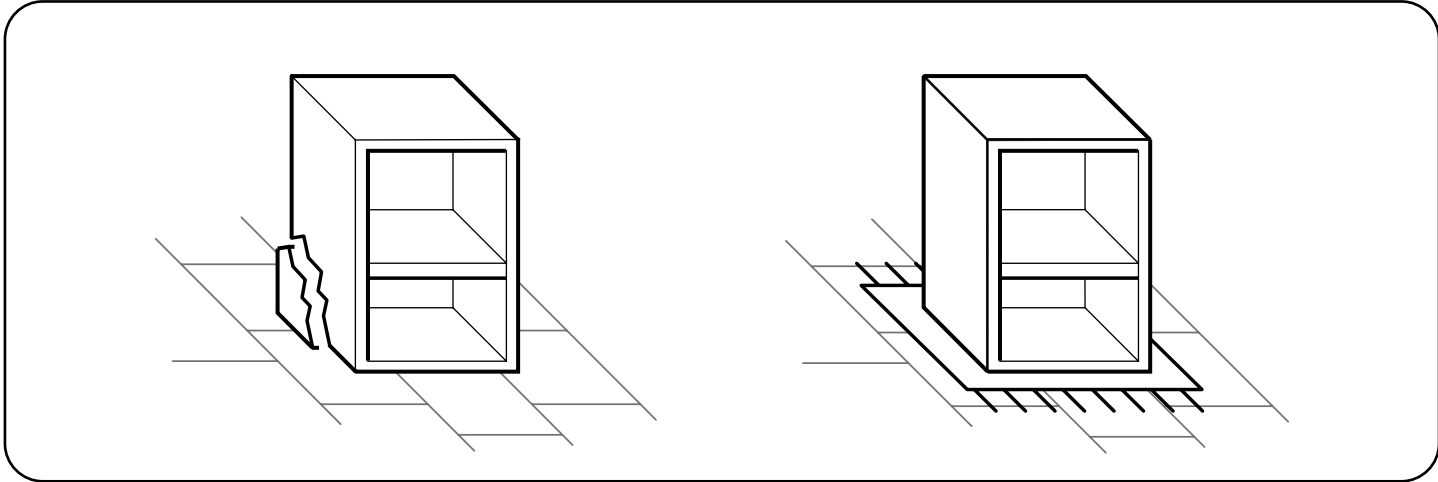

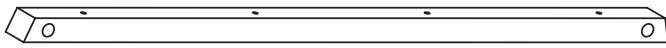

1 Querstrebe  
2x

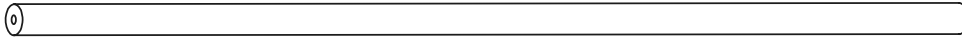

2 Kleiderstange  
1x

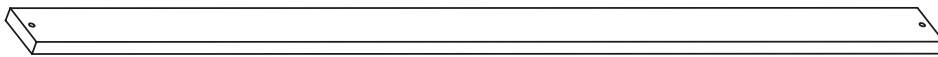

3 Latte  
4x

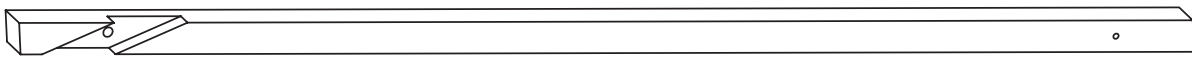

4 Bein  
2x

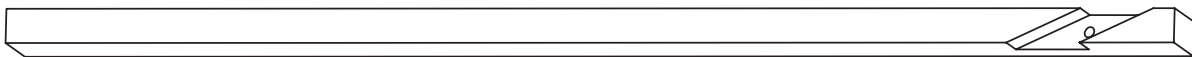

5 Bein  
2x

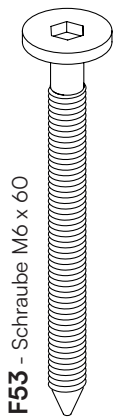

F53 - Schraube M6 x 60

2x



W43 - Schraube 7 x 38

4x

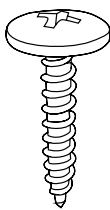

W41 - Schraube 4 x 35

8x

L10 - Filzleiter

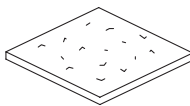

4x

T10 - Inbusschlüssel

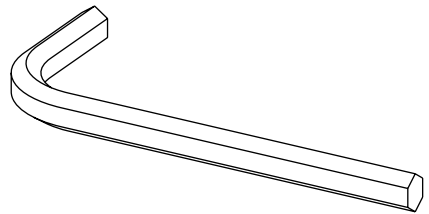

1x

# Ein letzter Check:

Bitte überprüfe, ob Du alle Teile hast.

Viel Spaß beim Aufbau!

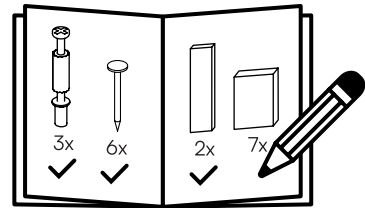

1

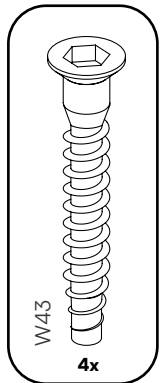
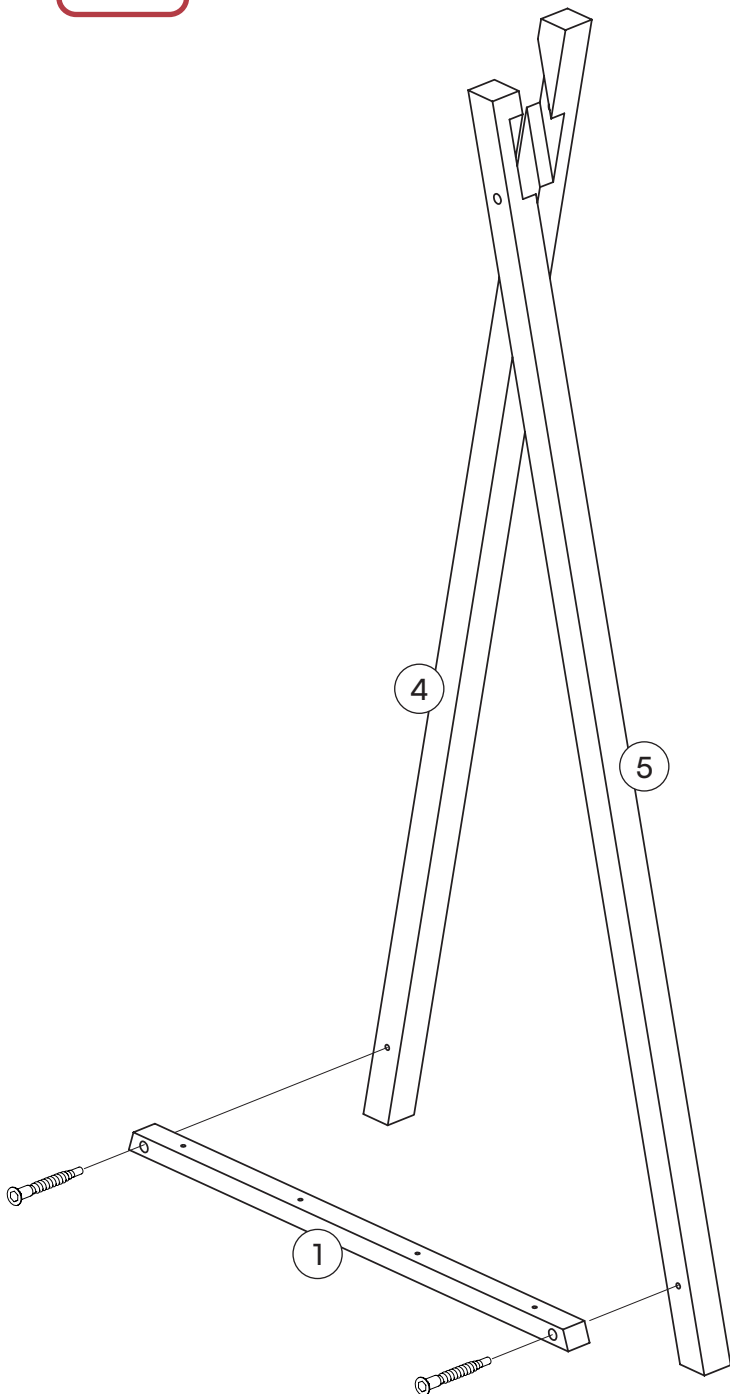

# 2

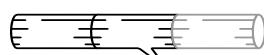
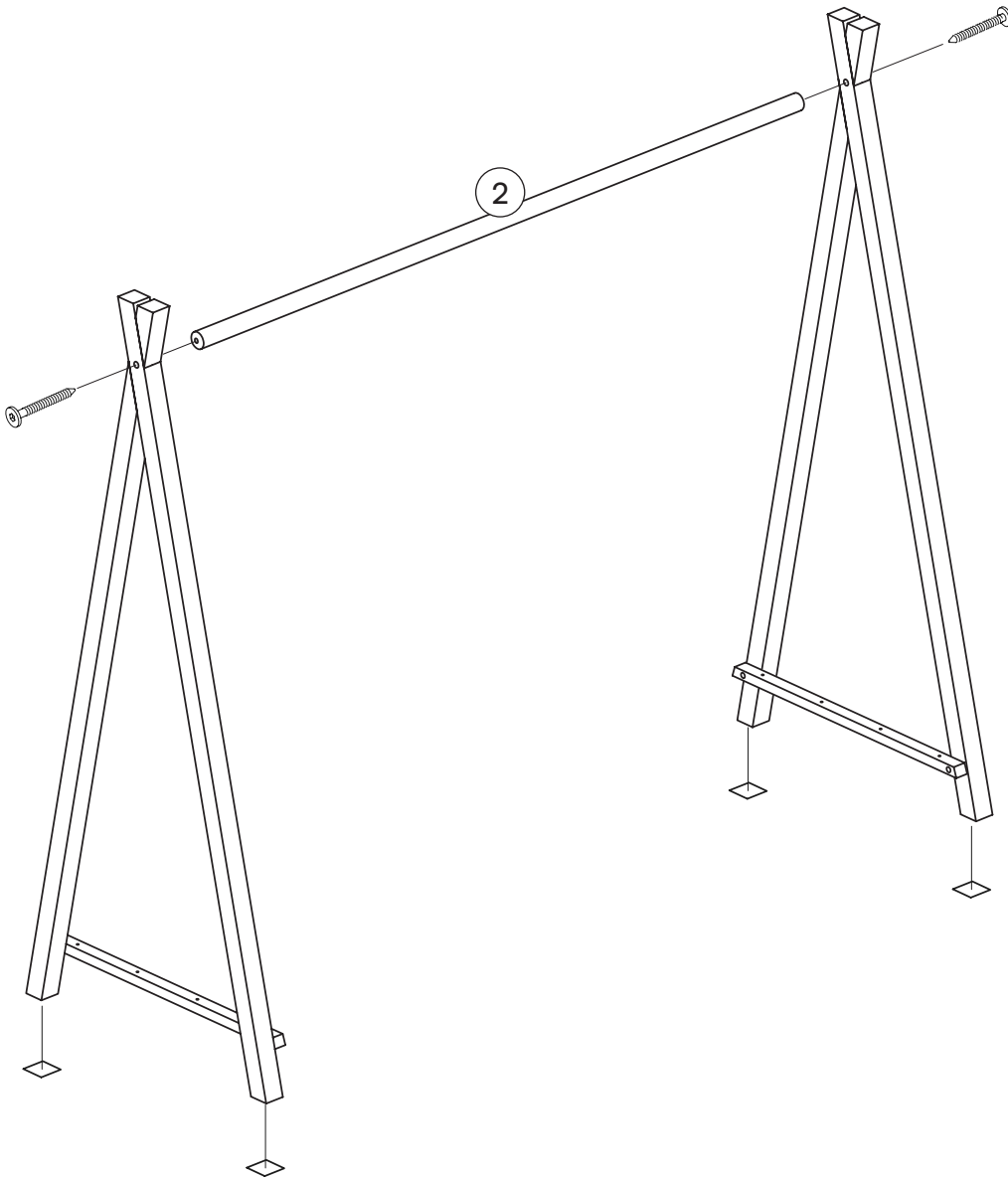
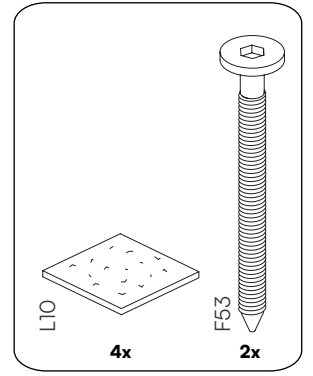

# 2

