

INSTRUKCJA MONTAŻU
ASSEMBLING INSTRUCTIONS

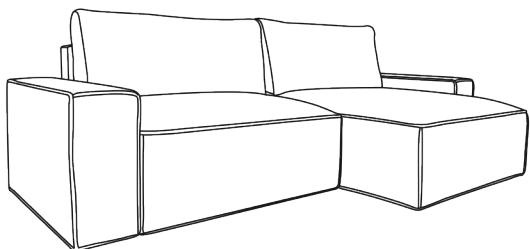









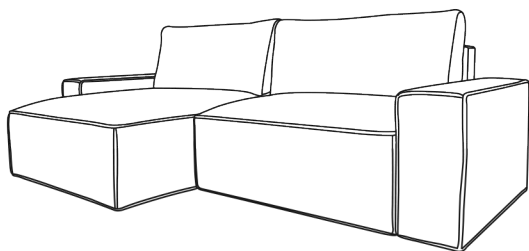

Rhf

NEXT

2023/04/12

Lhf



A	B	C	D	E	F	G	H	I
Ø 8mm	Ø 8mm	Ø 8x50	Ø 3,5x35		M6x20mm		2,5cm	4x45mm
								
x2	x2	x2	x6	x4	x16	x4	x4	x4

!
Proszę zapoznać się z instrukcją przed rozpoczęciem montażu.

Before starting refer to the assembling instruction.

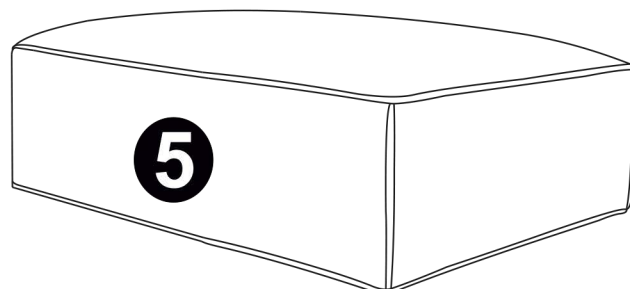
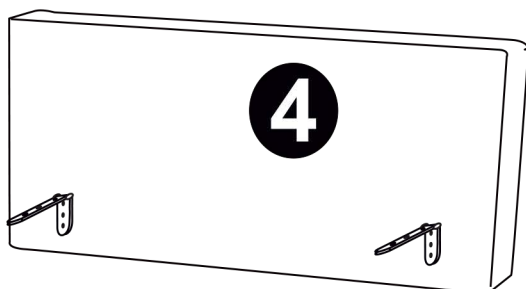
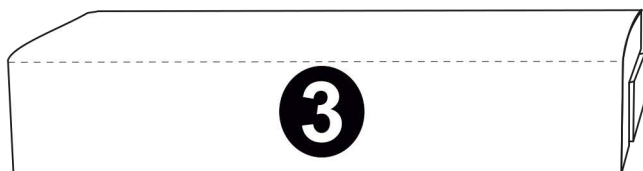
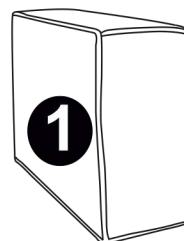
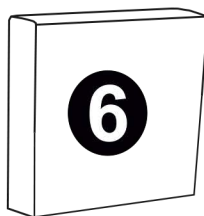
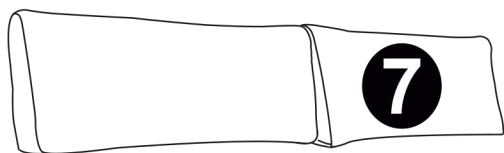

Rhf / Lhf

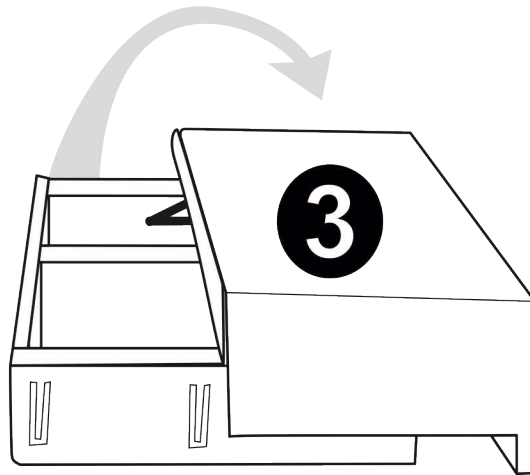

Rhf / Lhf

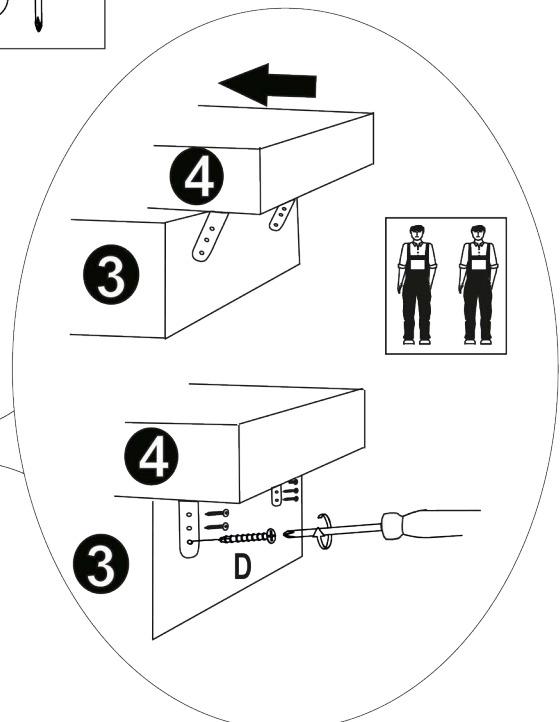
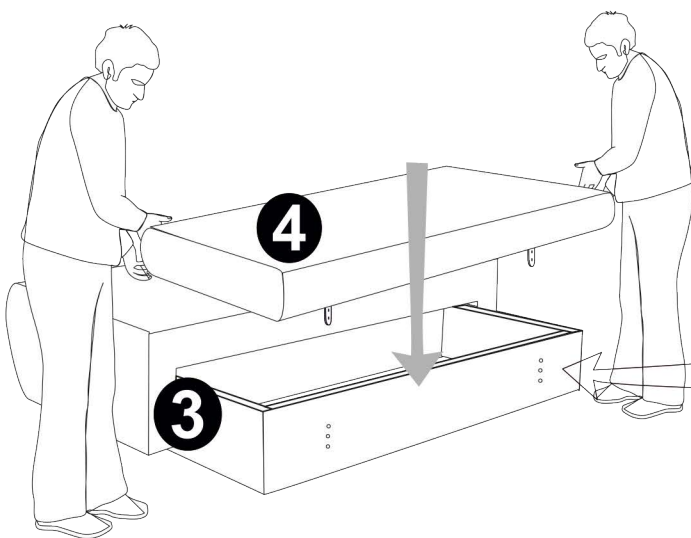
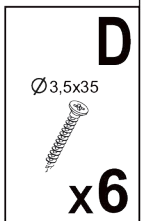
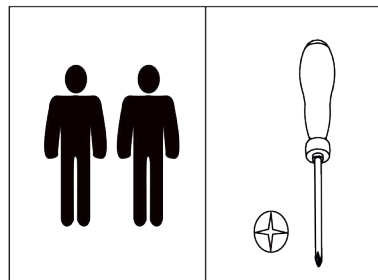

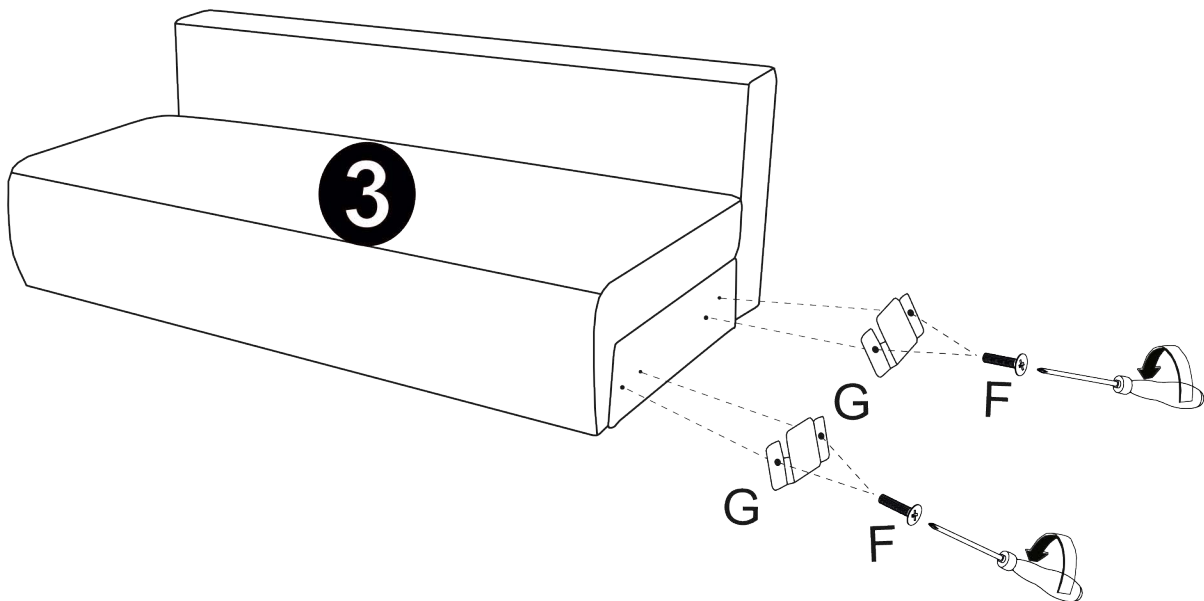
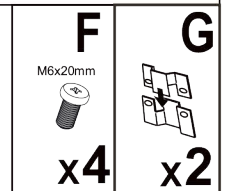
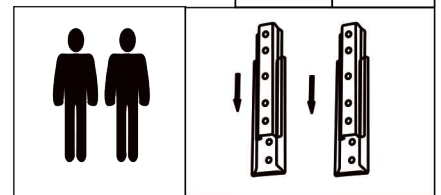
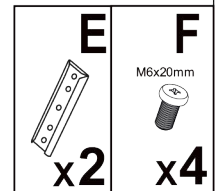
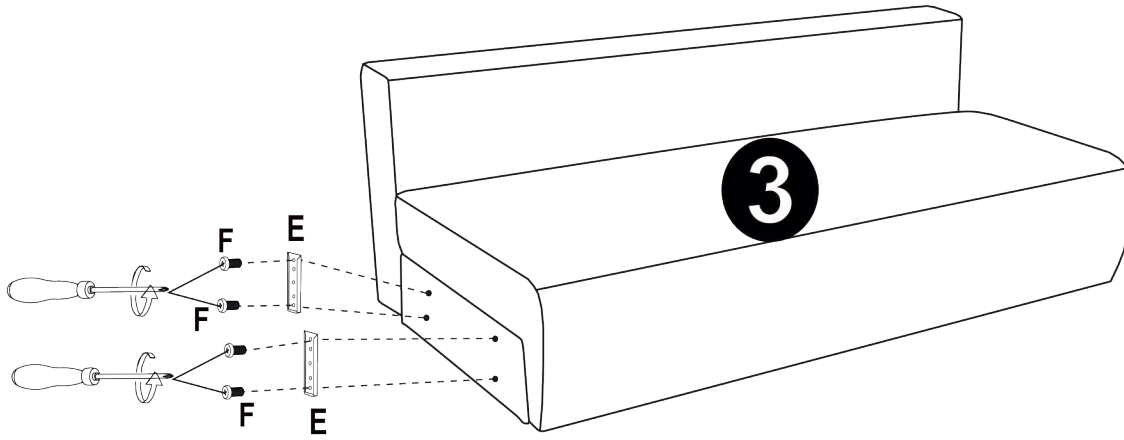

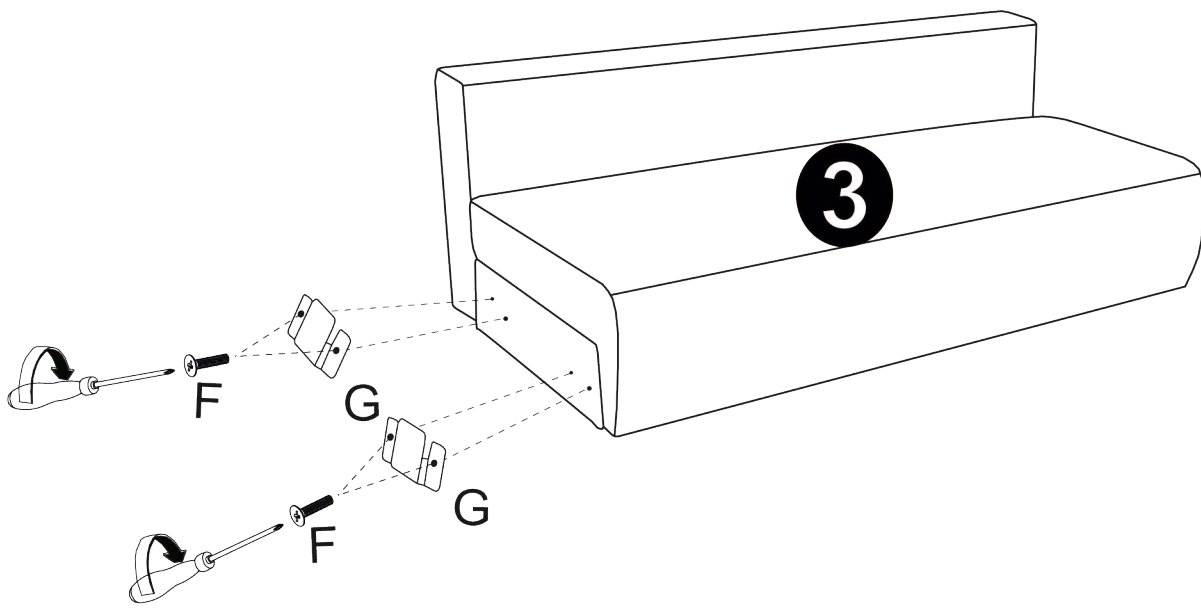
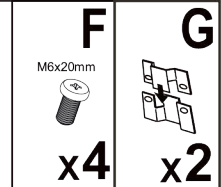
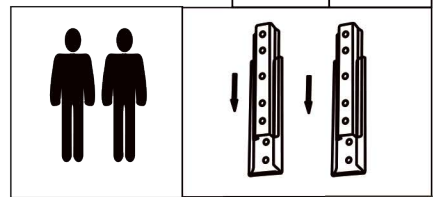
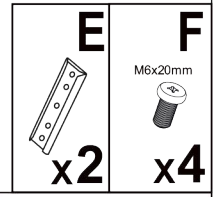
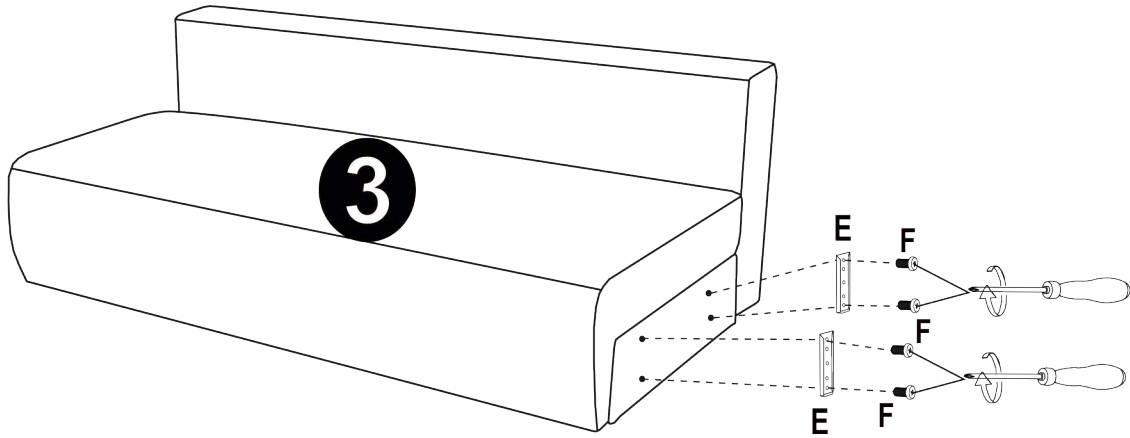



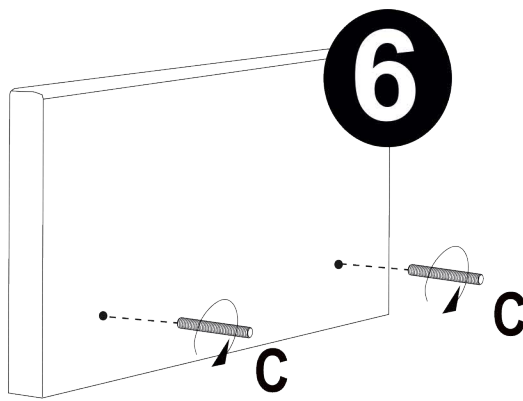

Rhf / Lhf



A Ø 8mm  x2	C Ø 8x50  x2
H 2,5cm  x4	I 4x45mm  x4

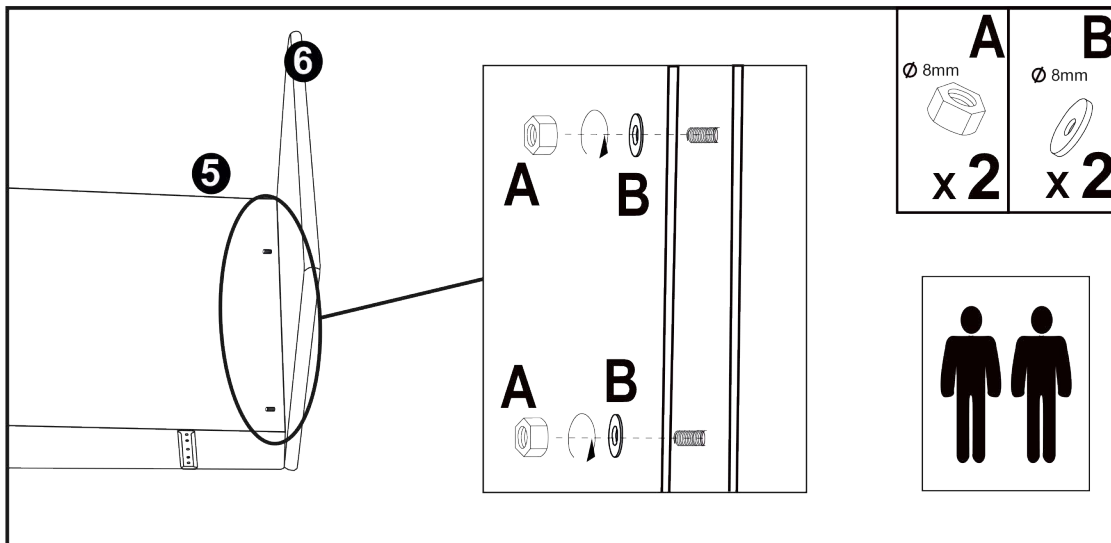
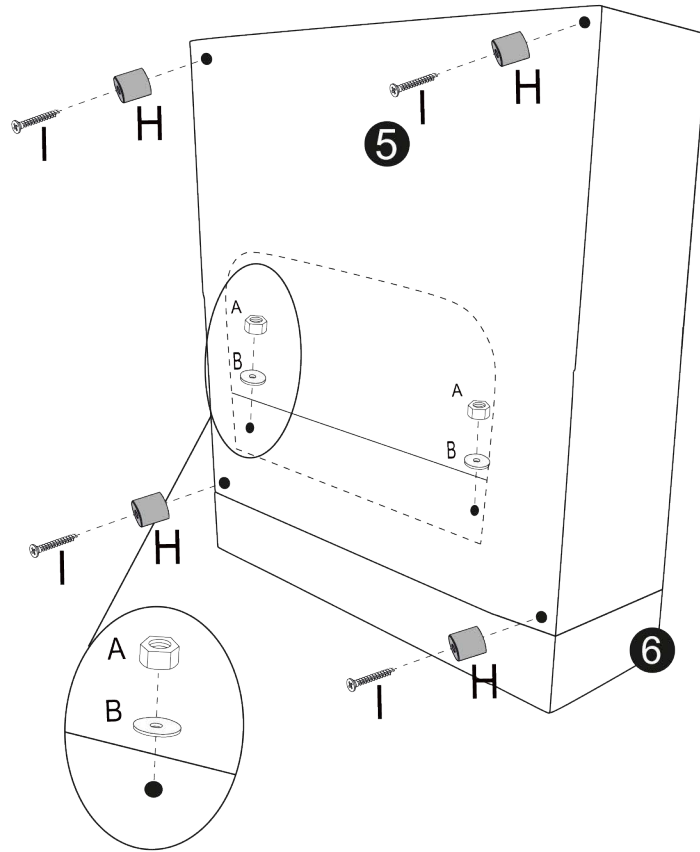

Rhf

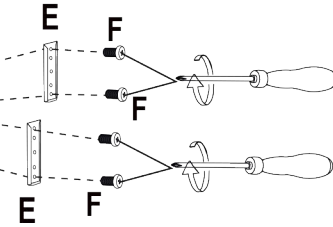
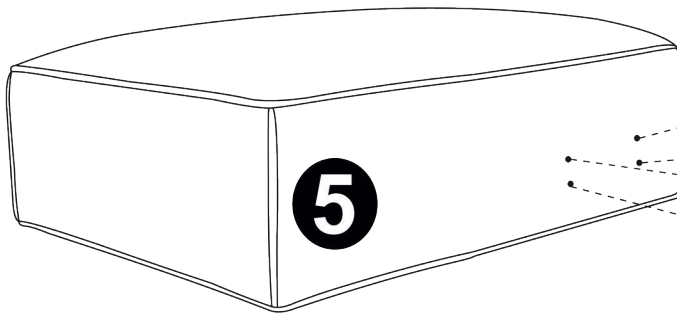
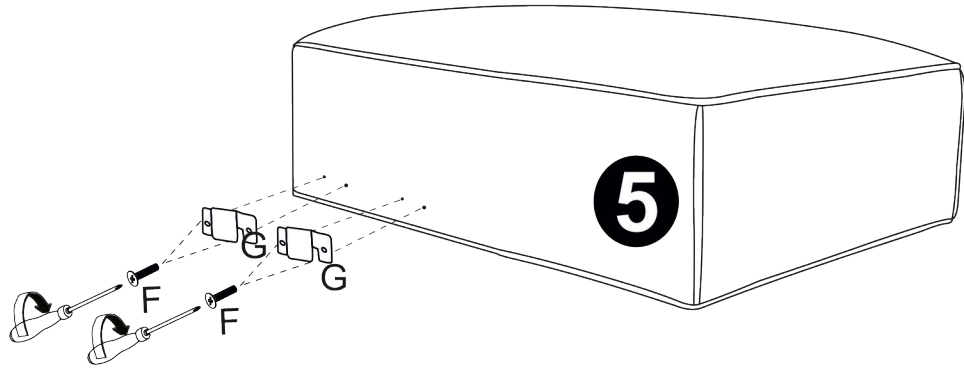
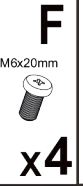
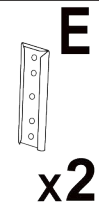
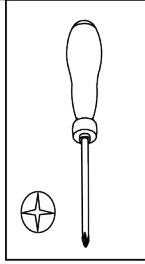

Lhf

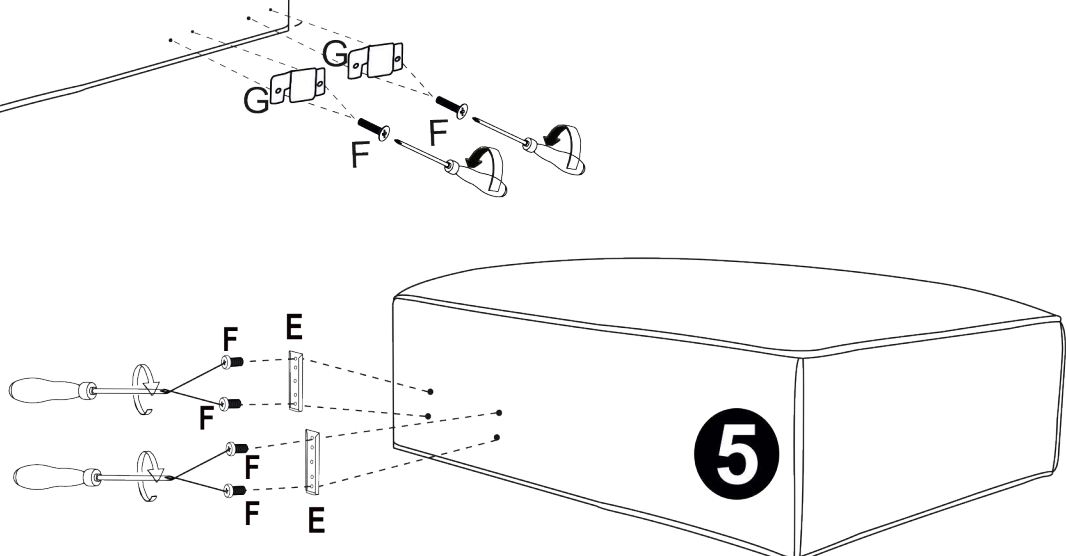
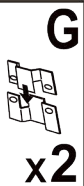
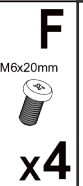
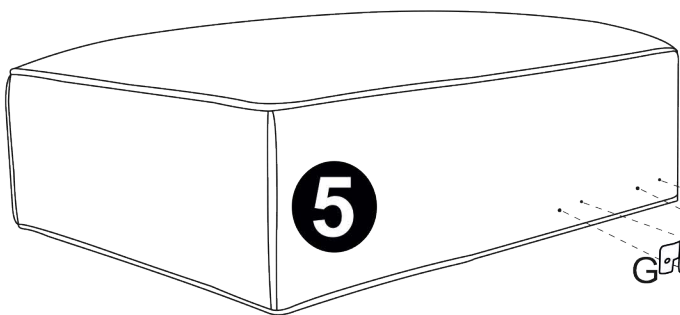
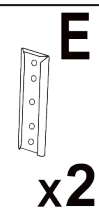
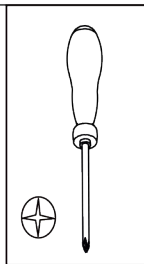

Rhf

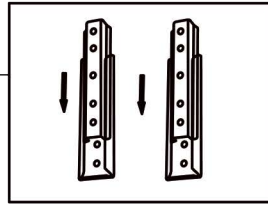
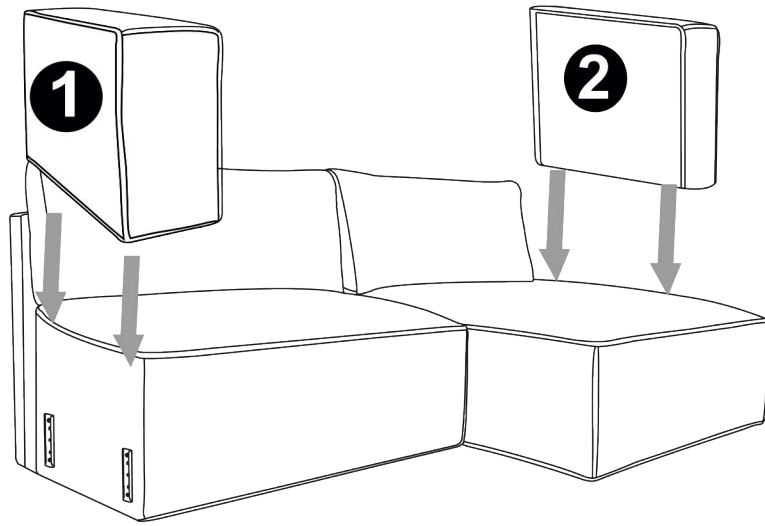

Lhf

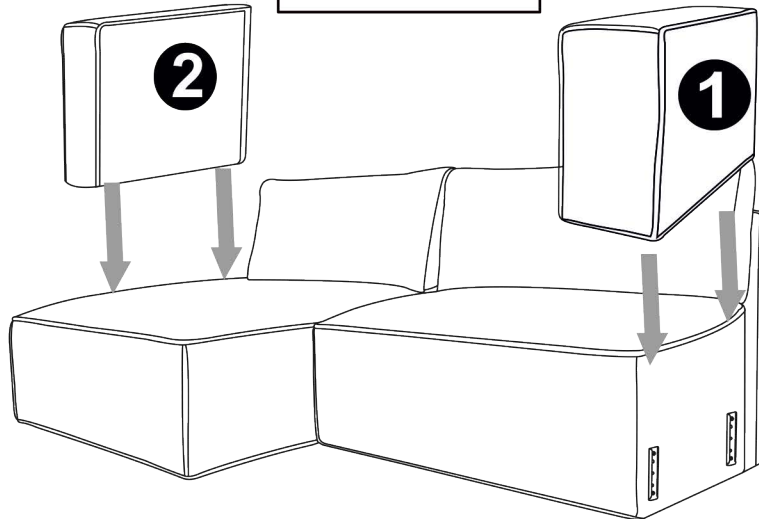

Rhf

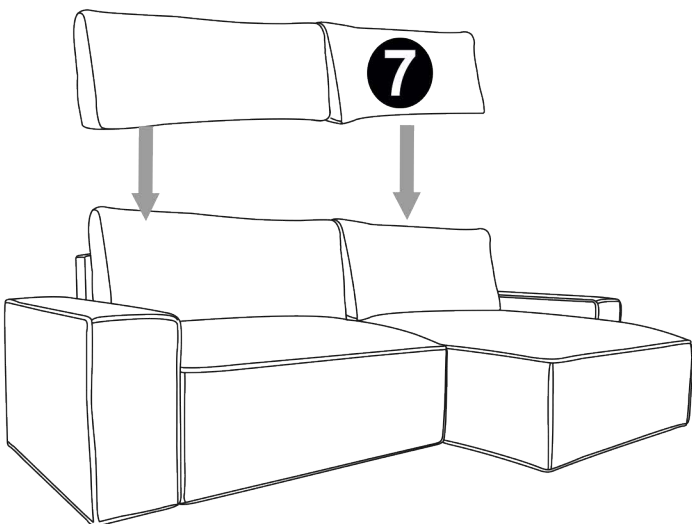

Lhf

