

MATILA

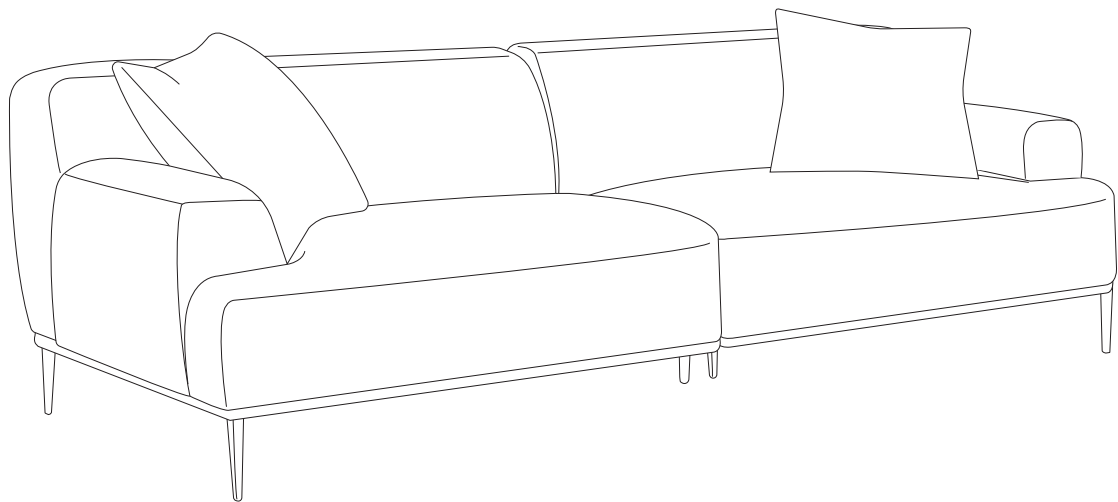

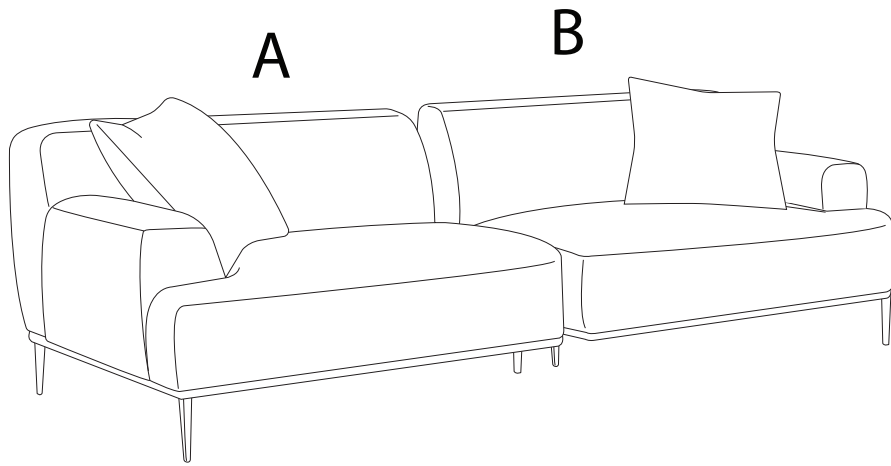

Assembly instructions for the sofa sections:

- Top Section:** A circular icon shows an Allen key. Next to it is a crossed-out power drill icon. To the right is a warning triangle with an exclamation mark. Further right is a circular icon with a clock face and a curved arrow, with the text '15'' below it.
- Bottom Section:** A circular icon shows a rectangular block being placed on a textured mat. Next to it is a crossed-out icon of a block being placed on a hard surface. To the right is a warning triangle with an exclamation mark. Further right is a stick figure icon with the number '2' below it.

A

A

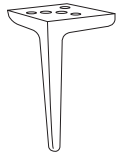

x 4

B

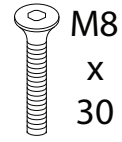

x 12

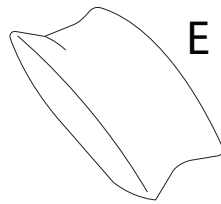

E

D

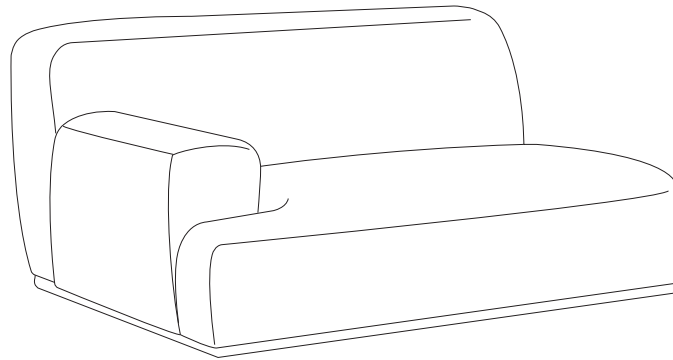

A x 4



C



x 1

D

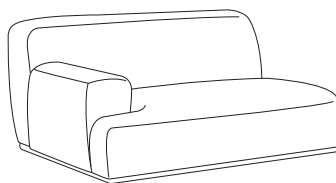

x 1

E

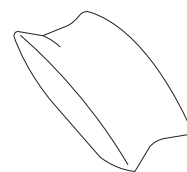

x 1

1

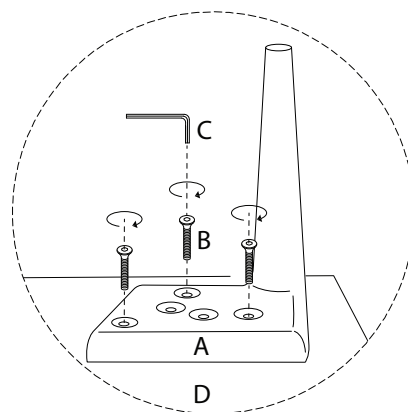
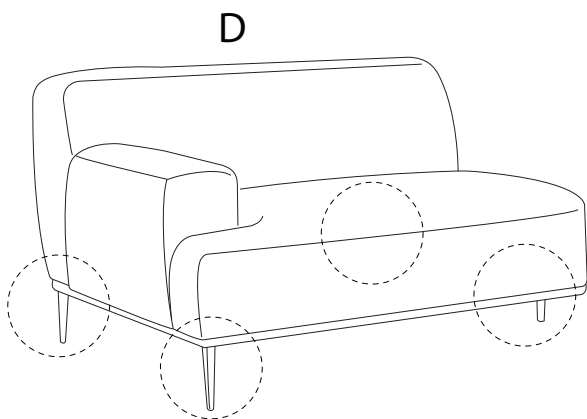
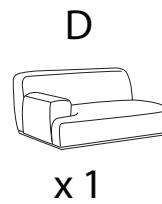
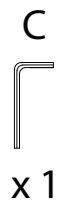
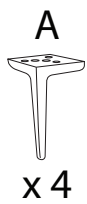

!

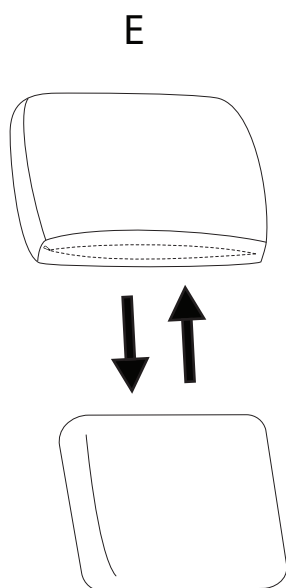
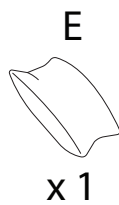

B

A

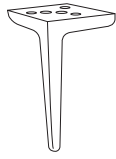

x 4

B

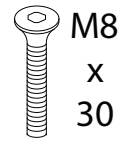

x 12

E

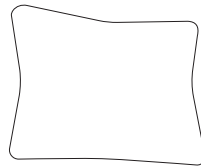

D

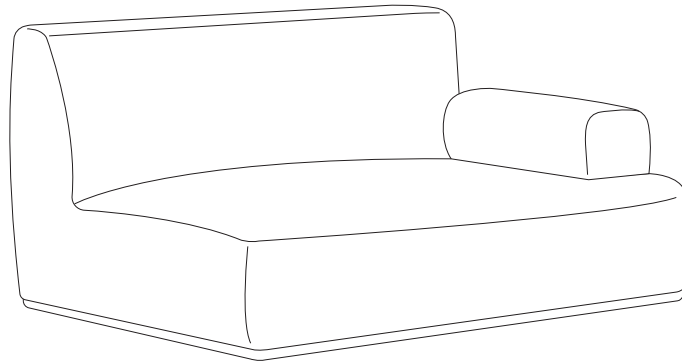

A x 4

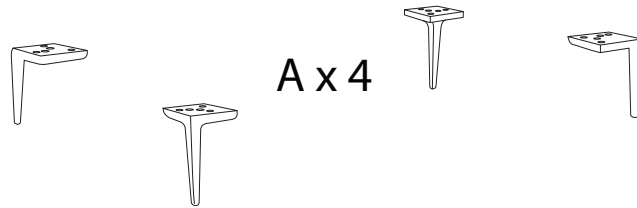

C



x 1

D

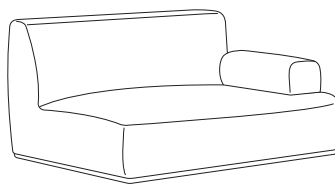

x 1

E

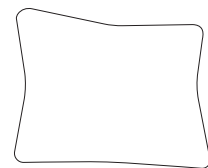

x 1

2

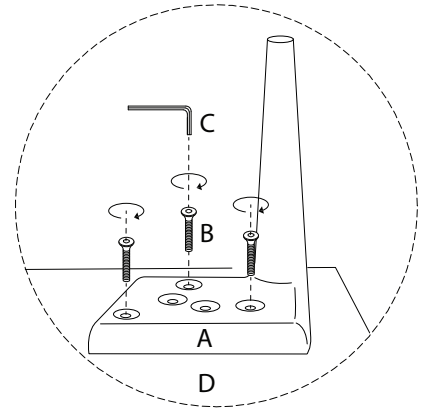
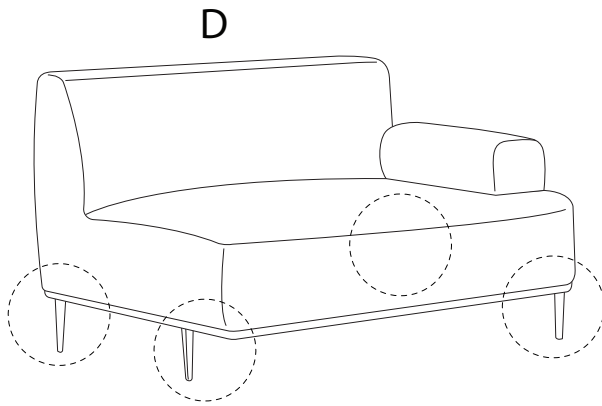
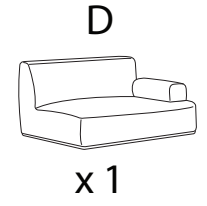
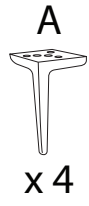

!

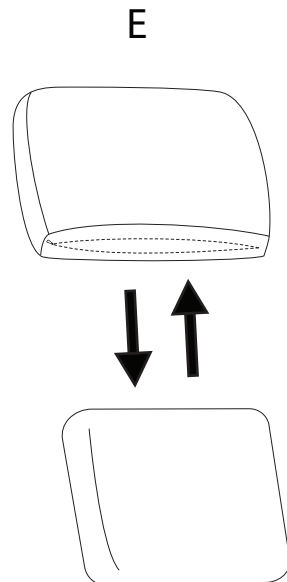
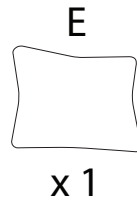

3

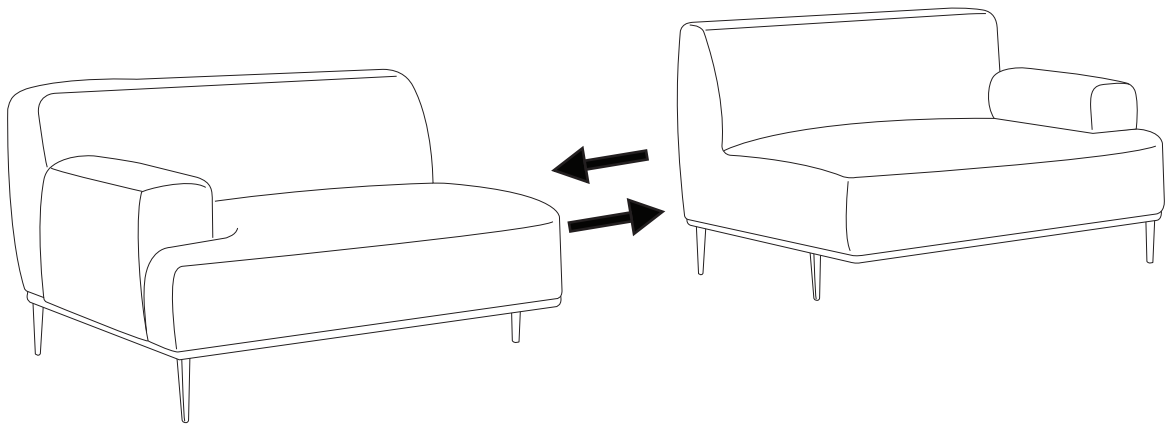

4

