

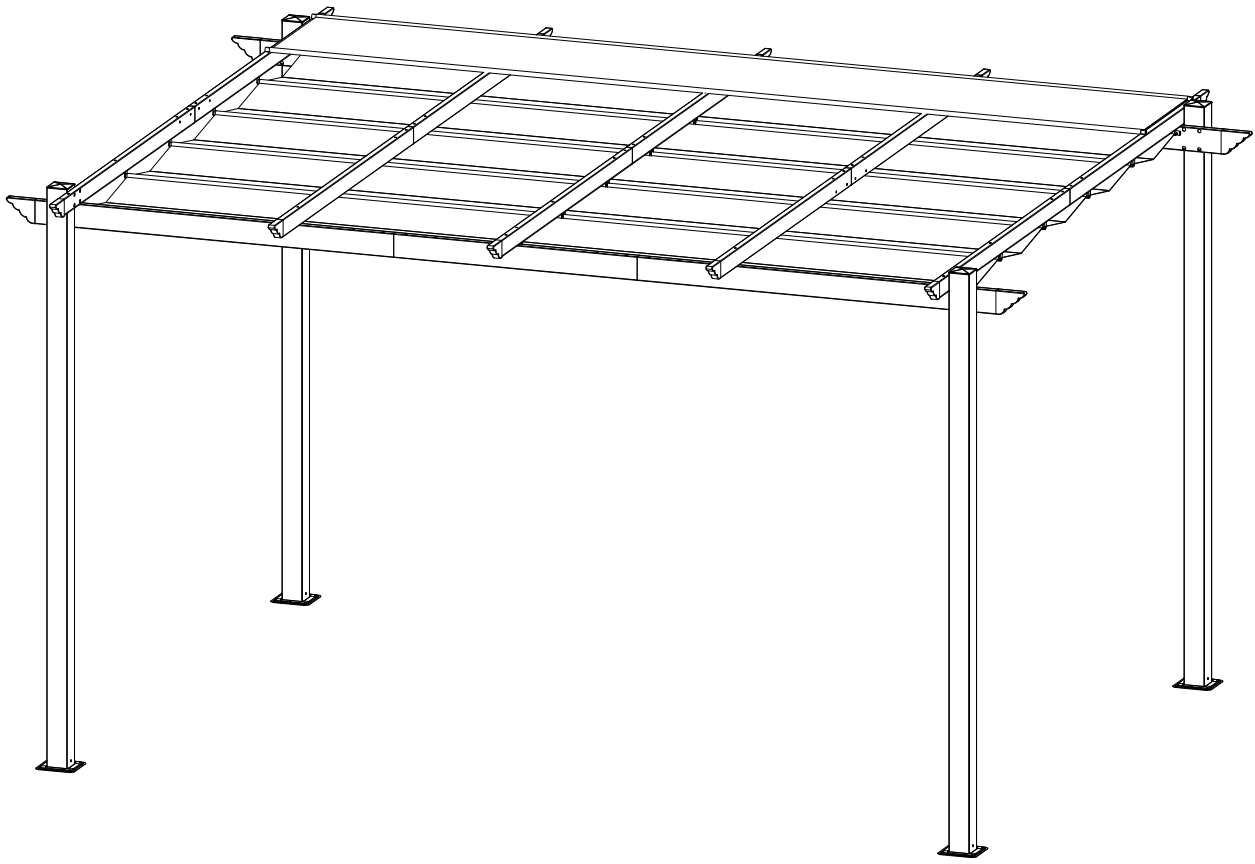

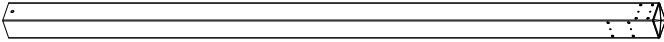

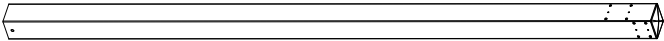

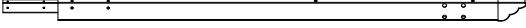



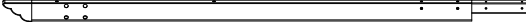
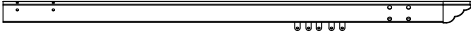
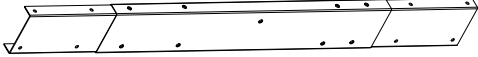
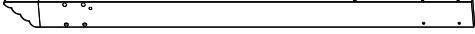
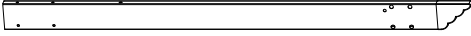
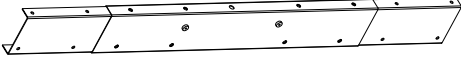
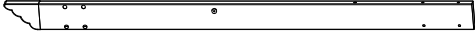
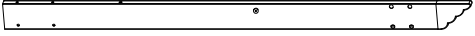
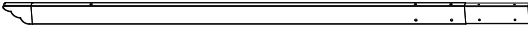

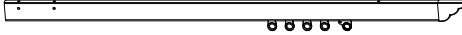





Product Instructions

3X4M

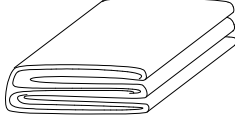
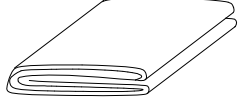
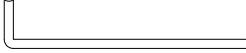

A1	2	
A2	2	
B1	1	
B2	1	
C1	1	
C2	1	
D	1	
D1	1	
D2	1	
E	1	
E1	1	
E2	1	
F1	2	
F2	2	
G1	1	
G2	1	

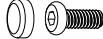
H1	5				
H2	5				
J1	3				
J2	3				
K	4		L	1	
M	1		N	1	
P	16		Q	1	

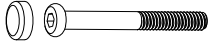
R	32	 M6*15	S	54	 M6*15
T	9	 M6*30	U	6	 M6*75

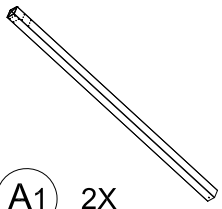

A1 2X

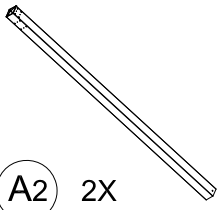

A2 2X

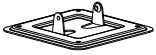

K 4X



M6*15

S 8X

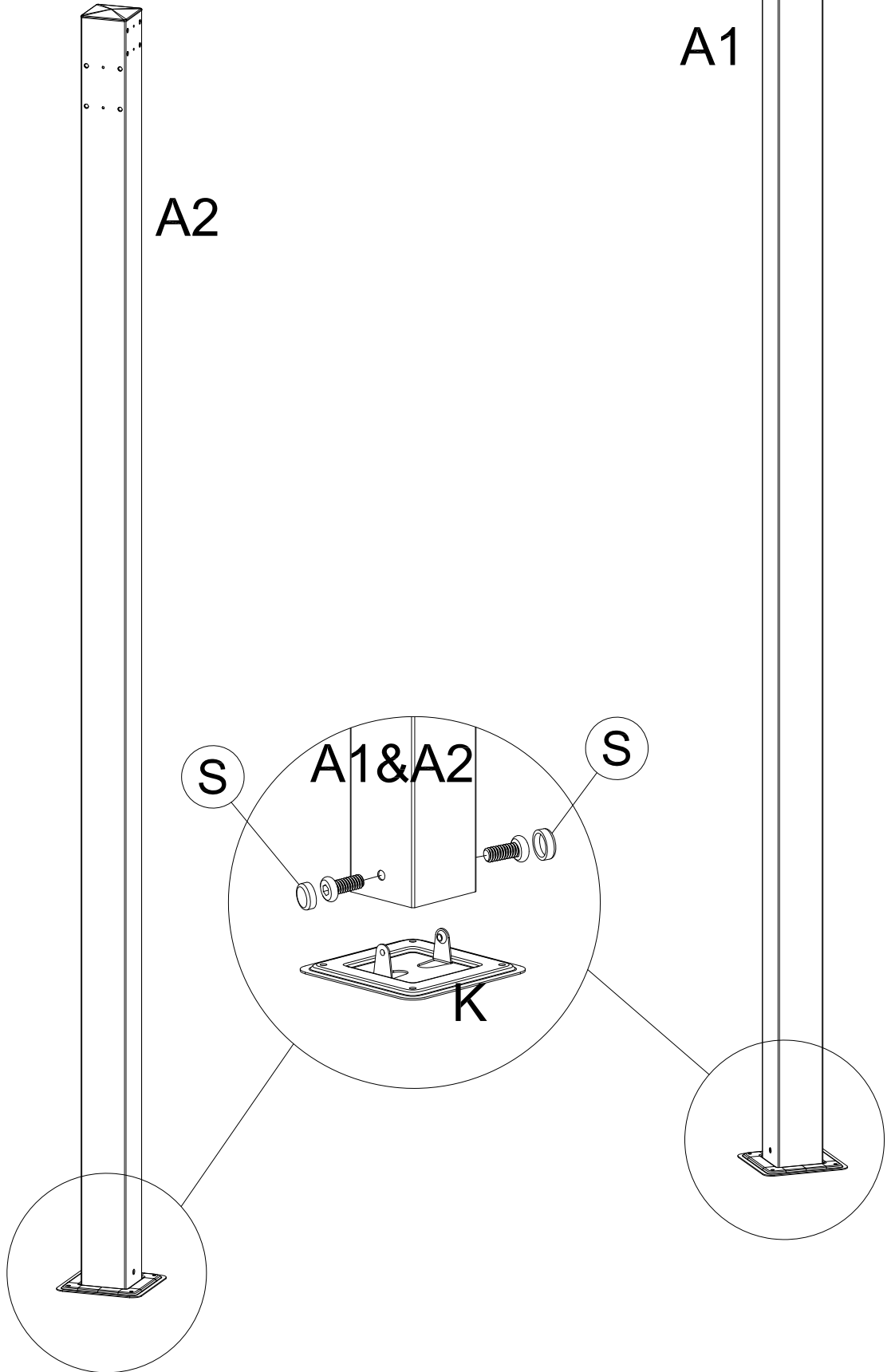



B1 1X

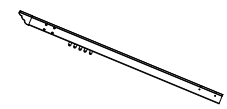

B2 1X



S 4X

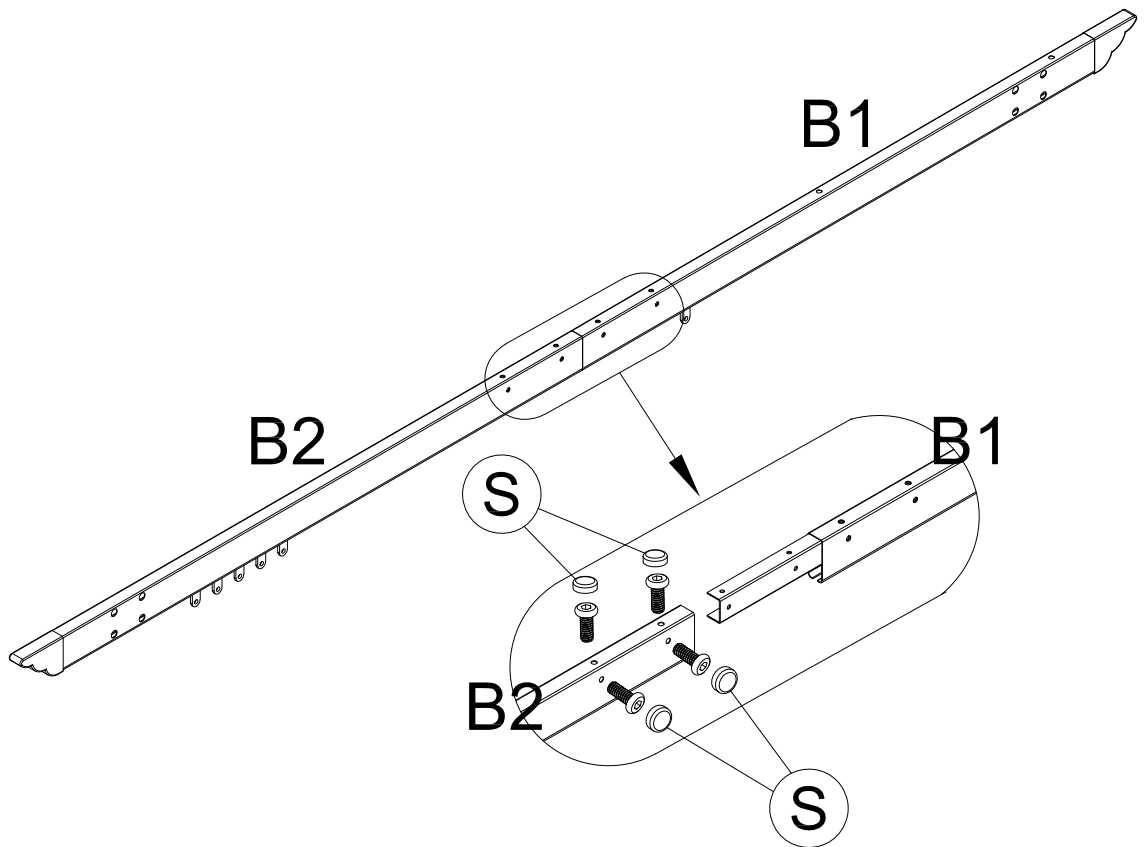

2

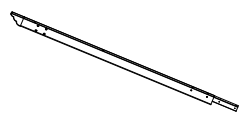

C1 1X

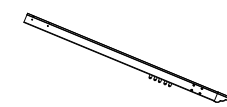



C2 1X



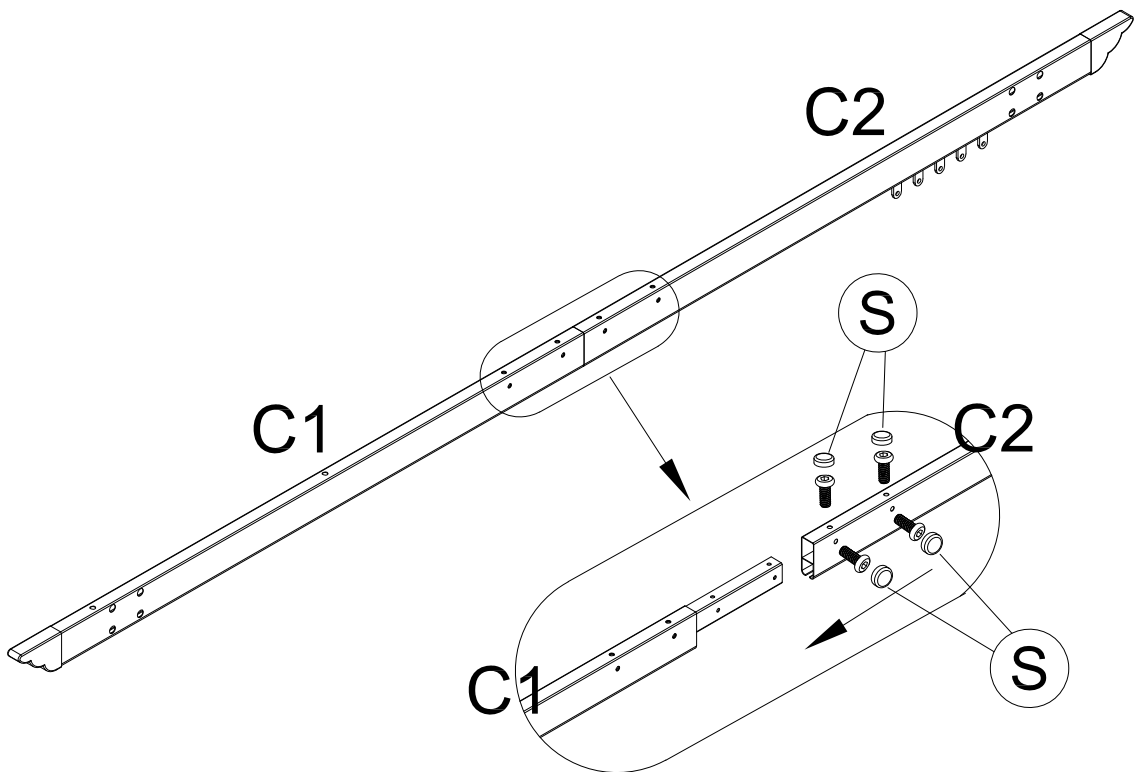

S 4X

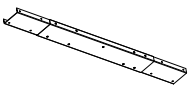
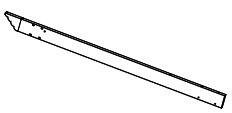
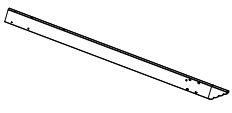

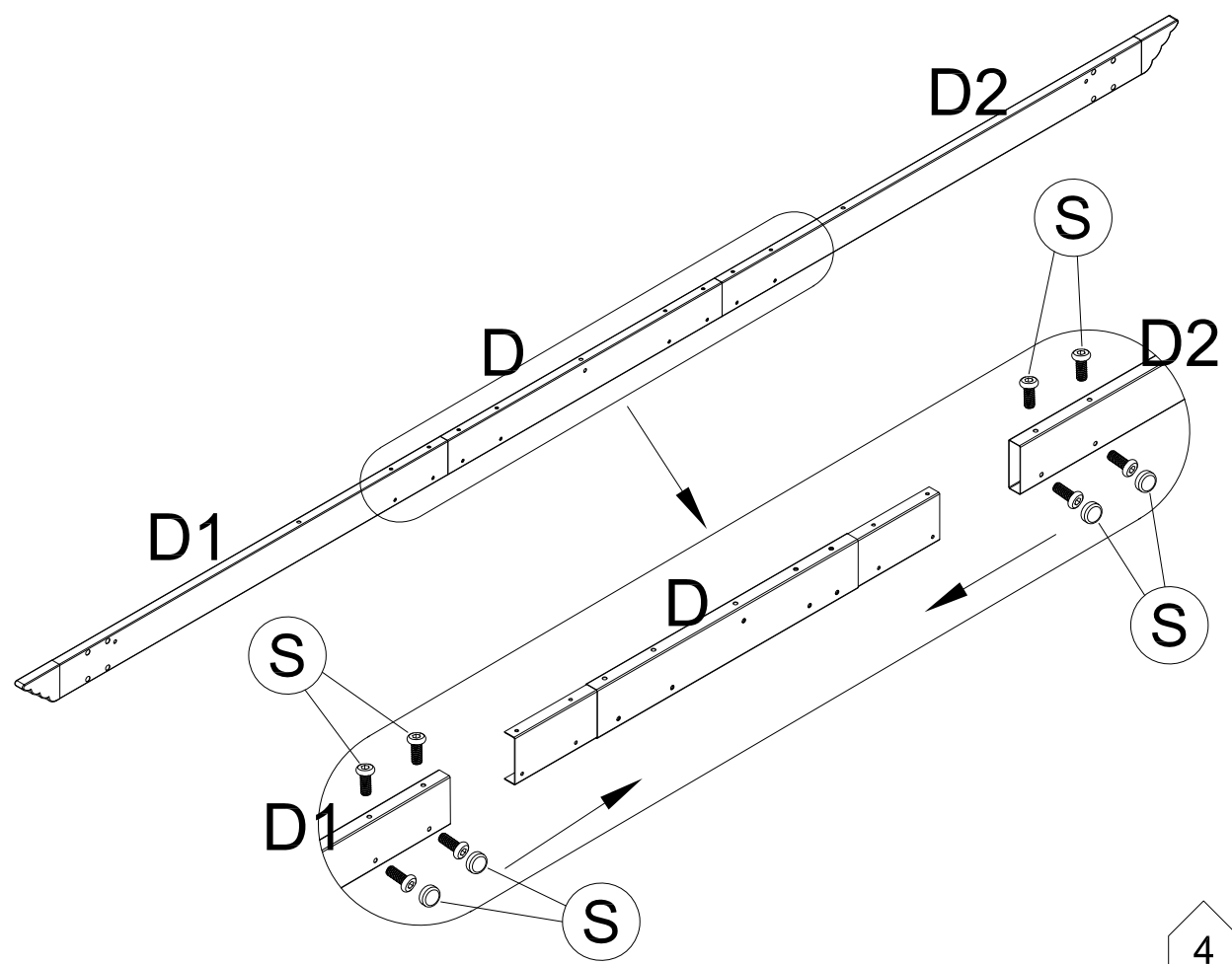

3

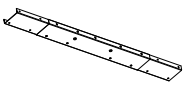
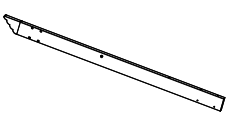
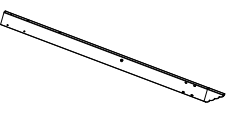
-  **D** 1X
-  **D1** 1X
-  **D2** 1X
-  **M6*15**
-  **S** 8X



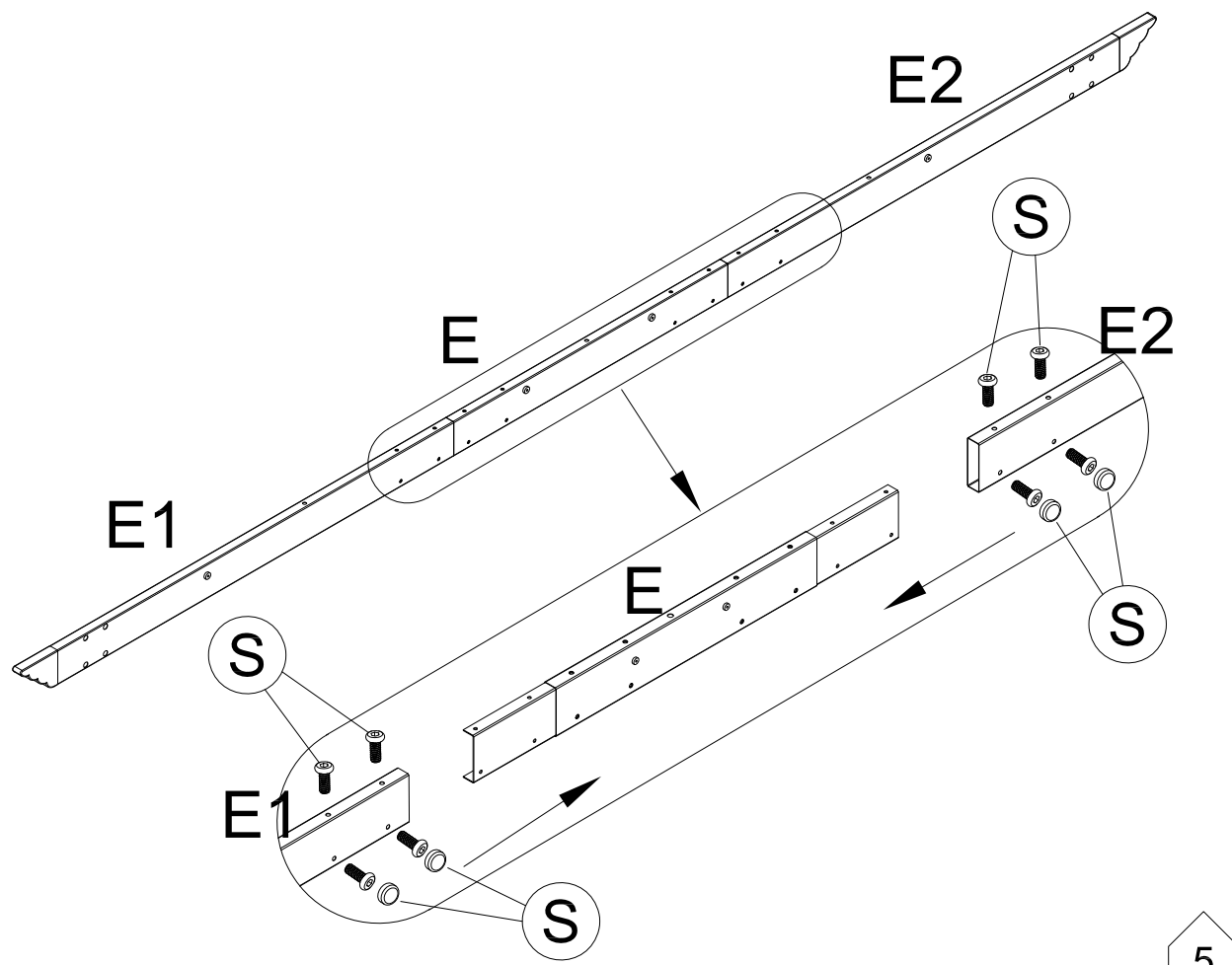

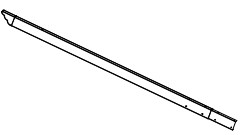
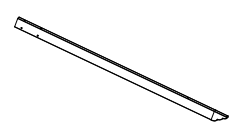
-  **E** 1X
-  **E1** 1X
-  **E2** 1X
-  **M6*15**
-  **S** 8X

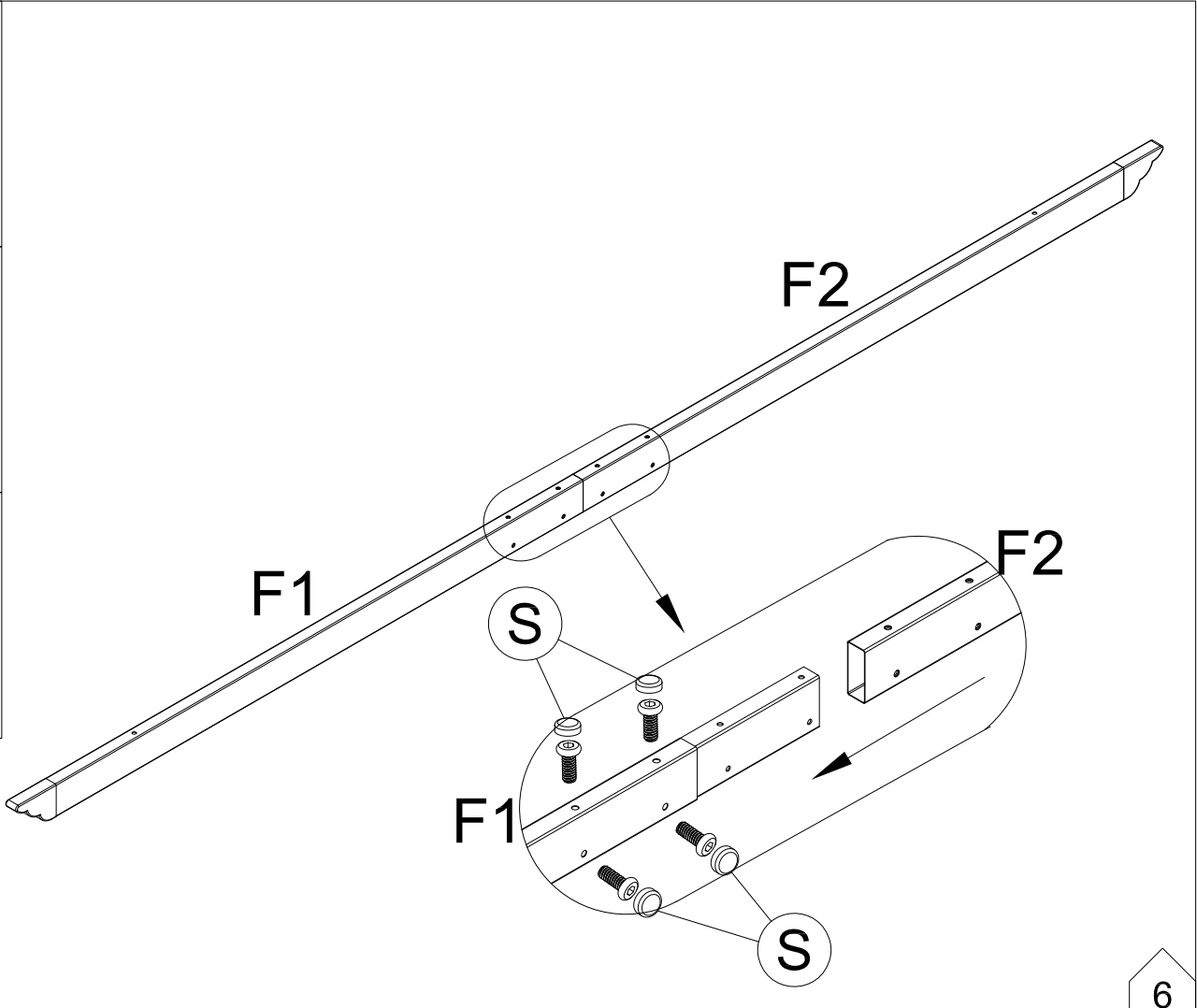

-  **F1** 2X
-  **F2** 2X
-  **S** 8X

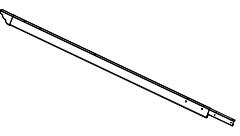
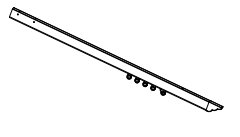

-  **G1** 1X
-  **G2** 1X
-  **S** 4X

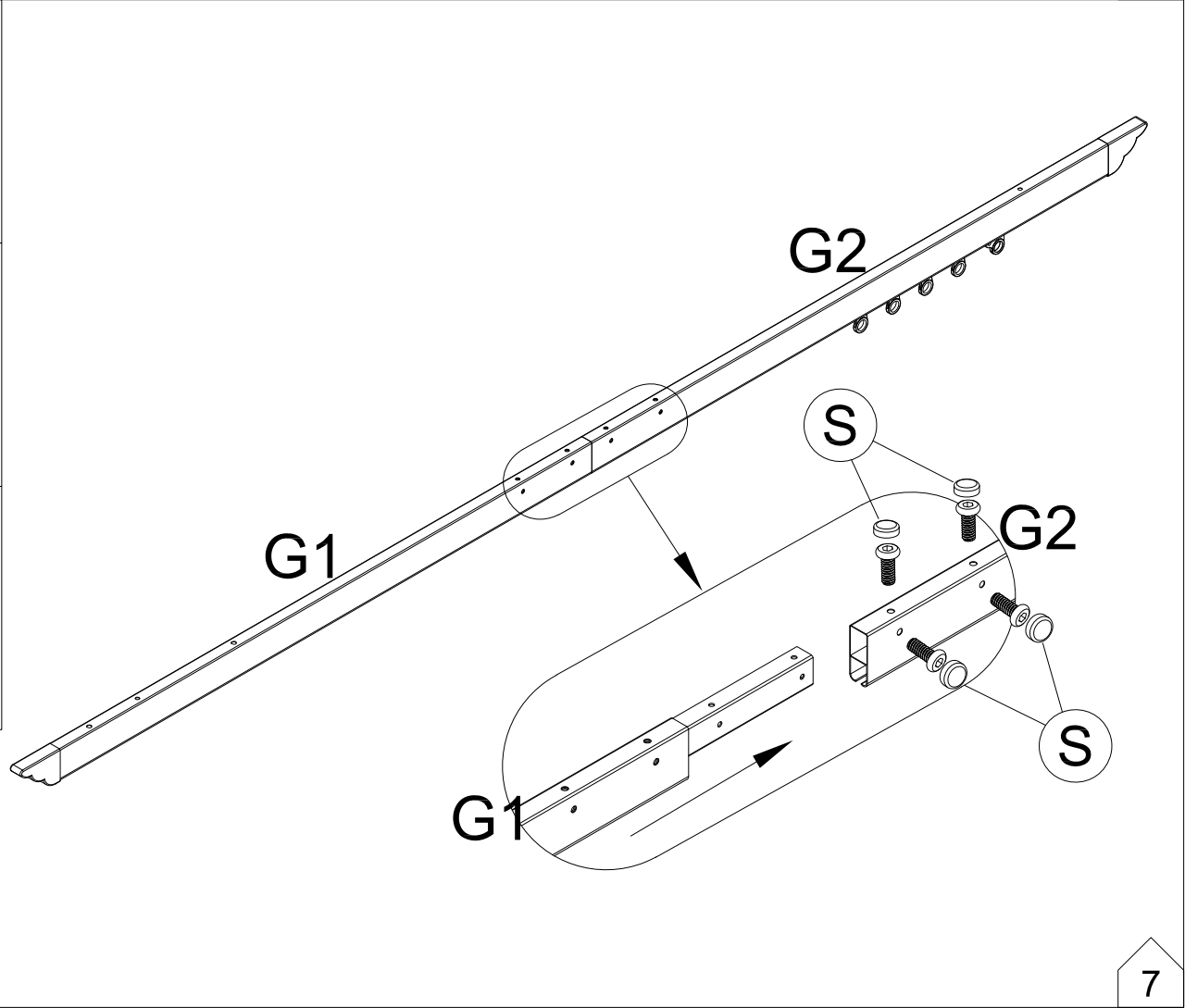



M6*15

(R)

16X

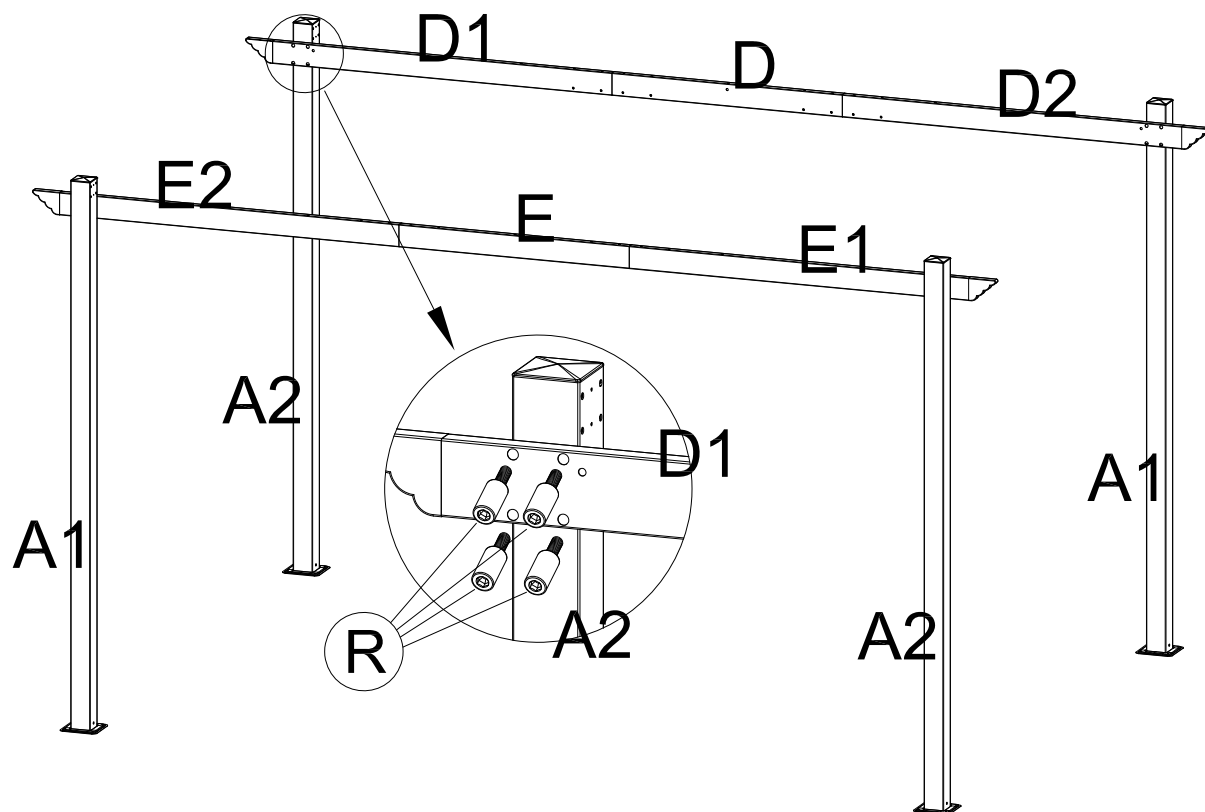

8



M6*15

(R)

16X

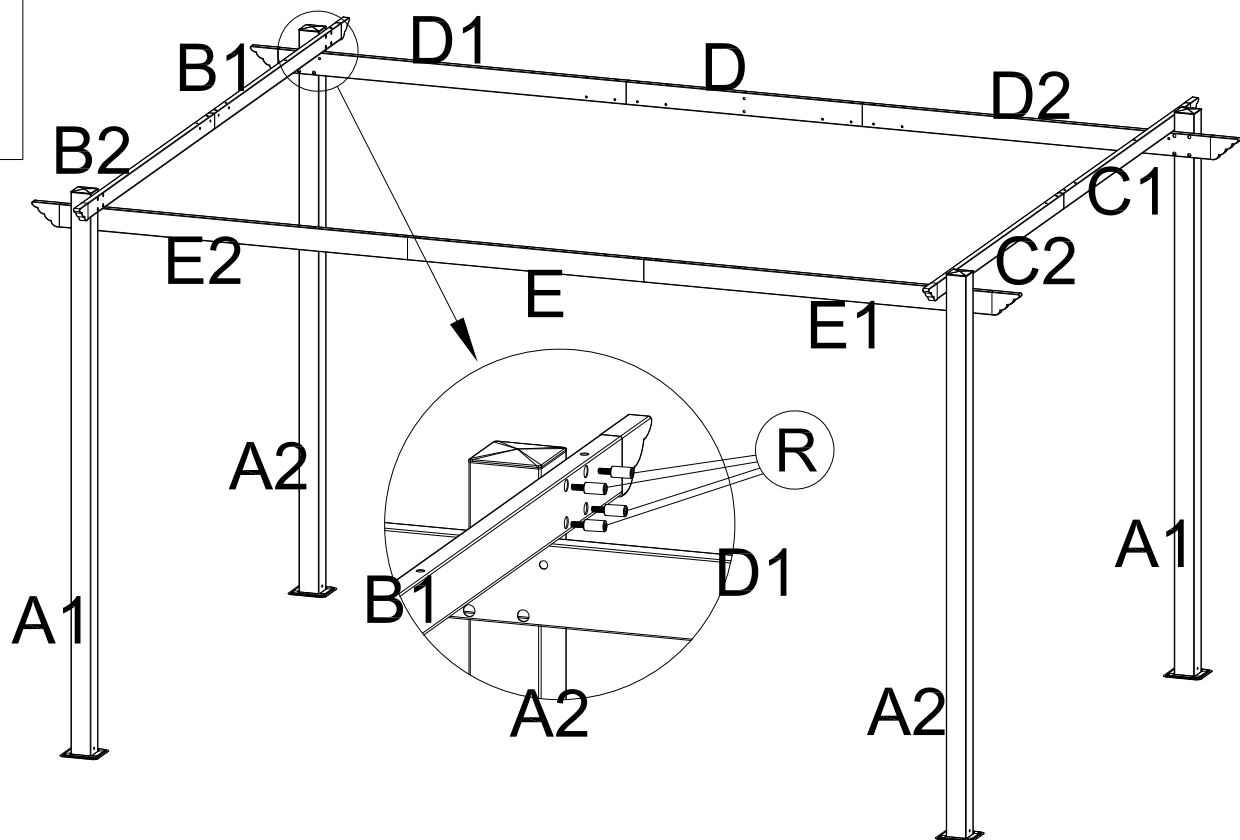

9

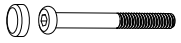

M6*75

U

6X

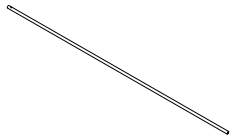
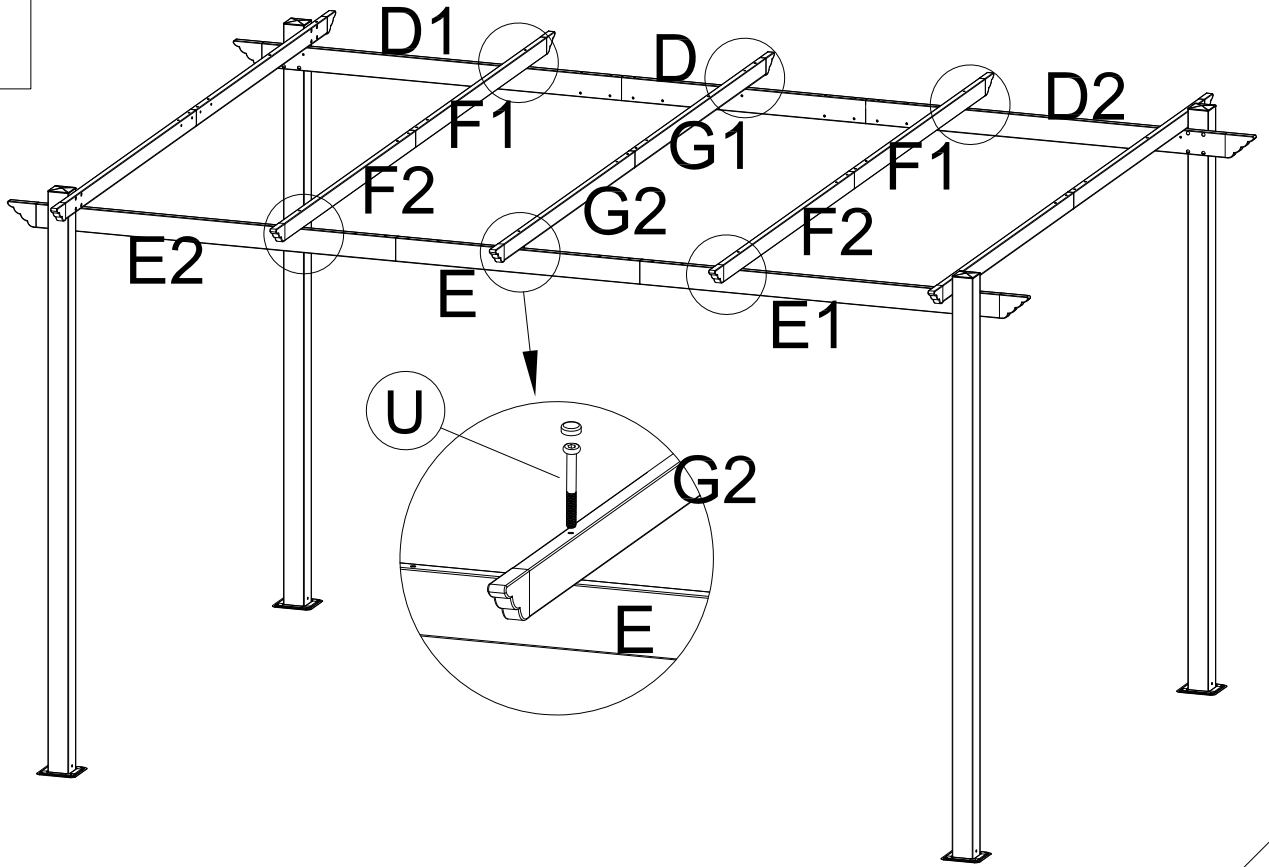

H1

5X

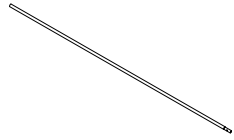

H2

5X

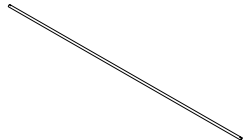

J1

1X

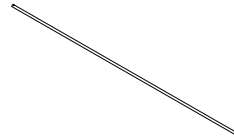

J2

1X

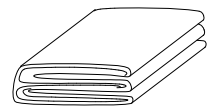

M

1X

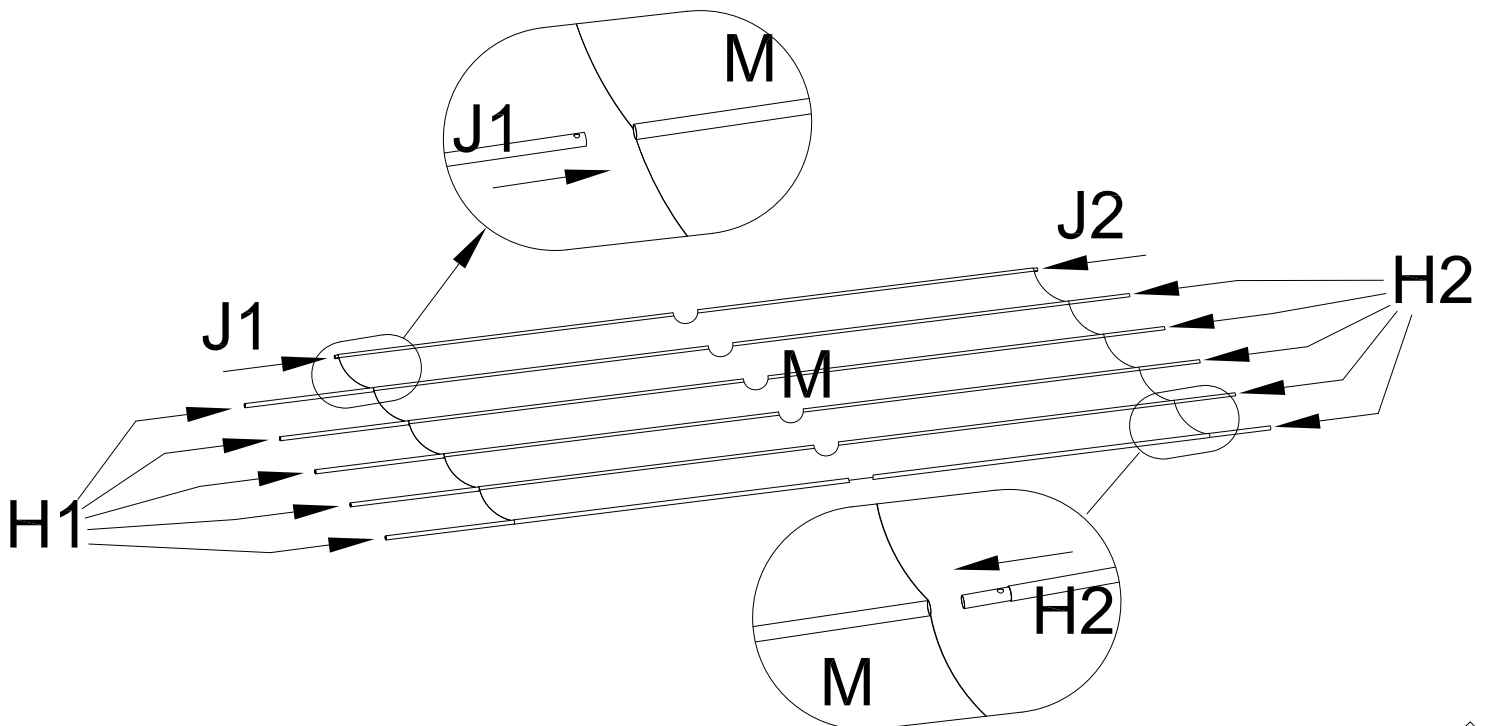



M6*30

T 6X

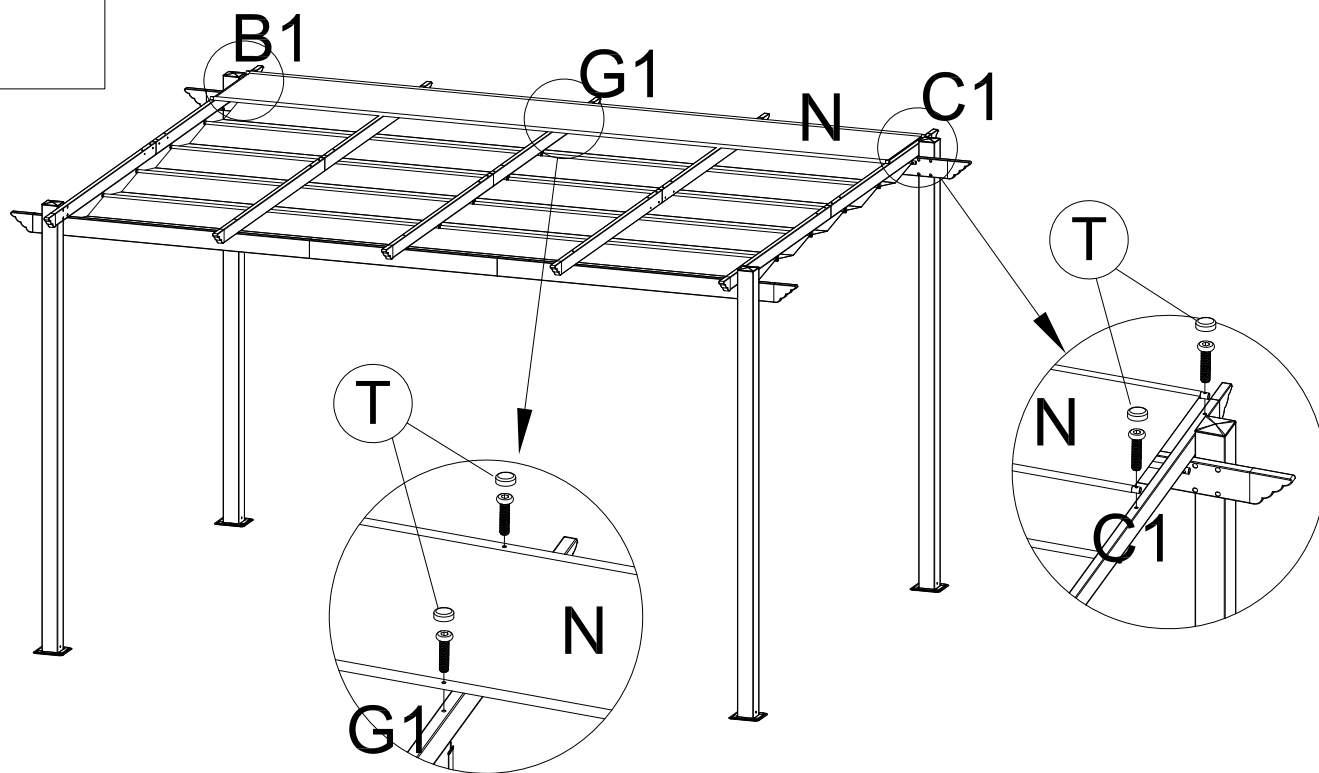

14



L 1X

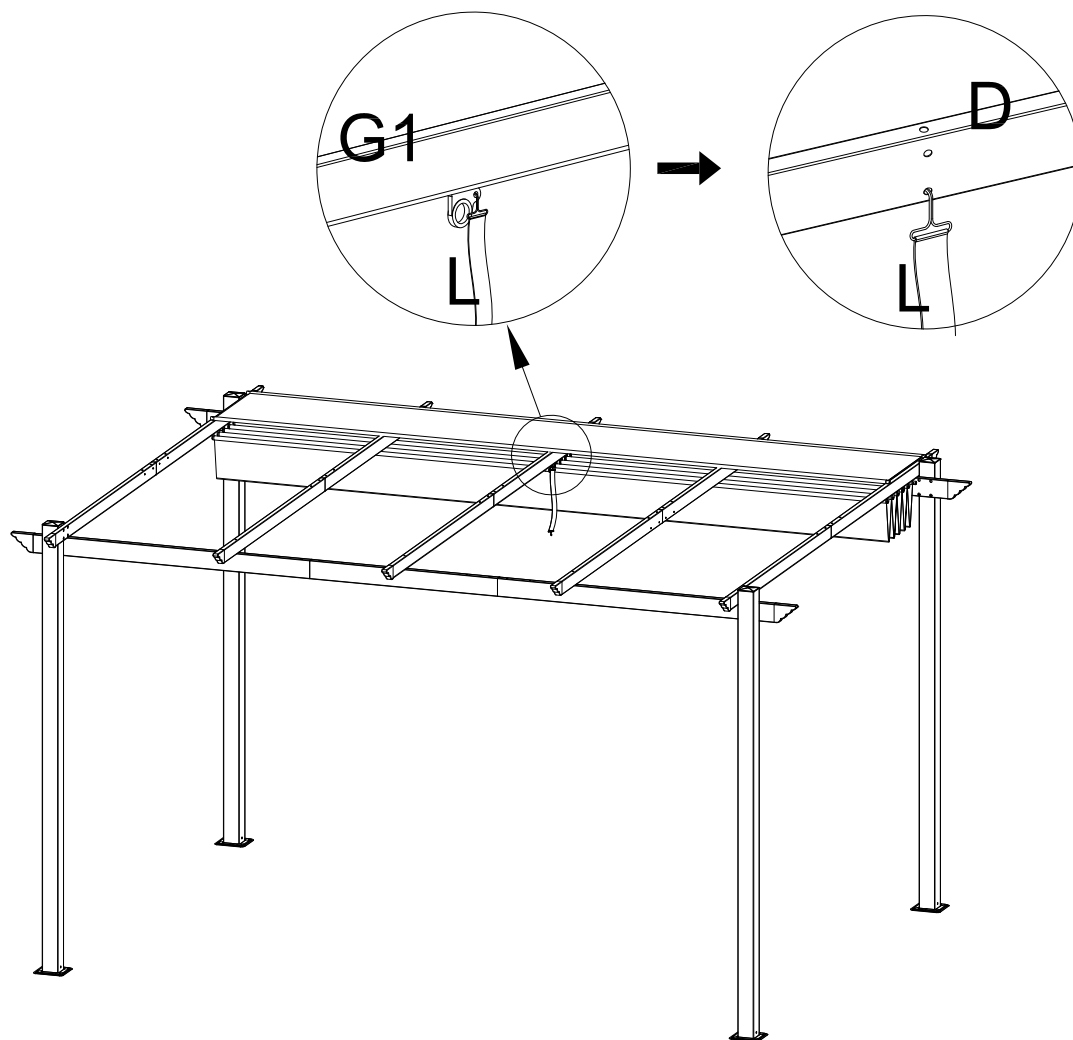

15

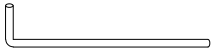

P

16X

