

REPC-Nr.:

Service • Assistenza • Dienstverlening • Serwis
Servis • Szerviz • Сервисная служба

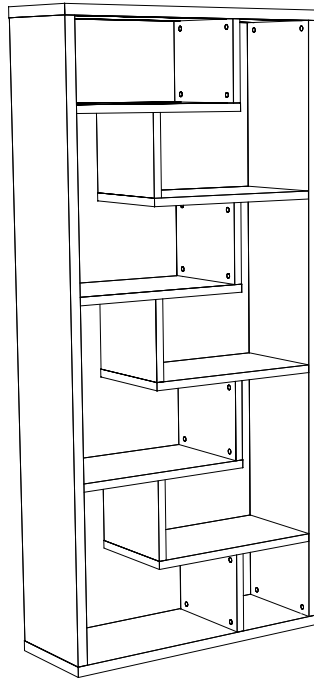

Artikel.-Nr.:

0501-RT_90

Montageanleitung.-Nr.:



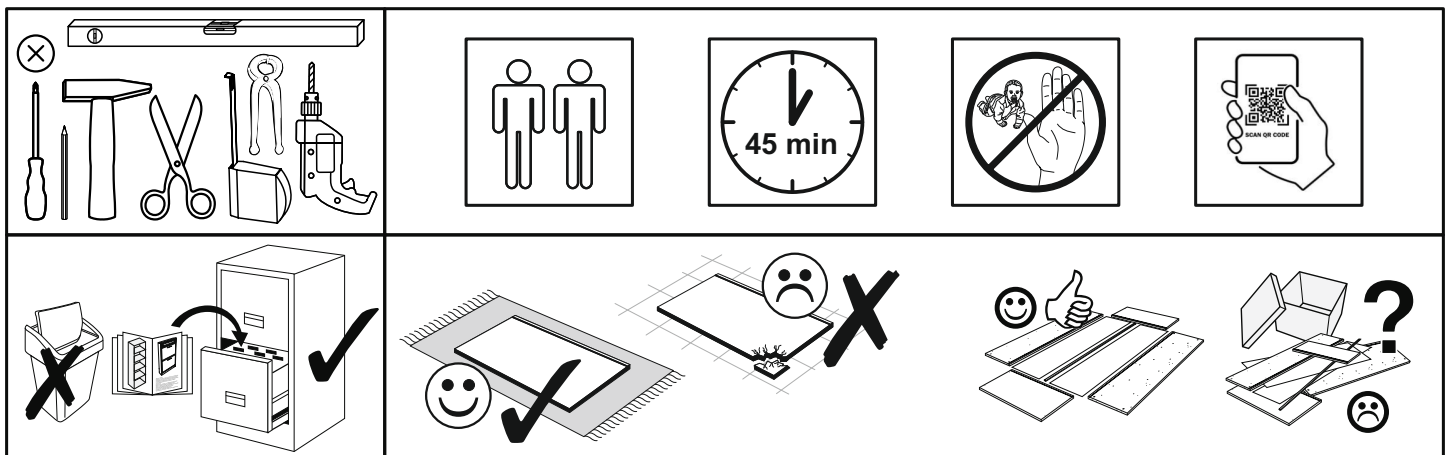

MA1-00134



SCAN ME

Das Ersatzteil-Anforderungsformular finden Sie auf
The replacement parts requisition form you find on
<https://www.mausbacher.de/ersatzteile/>

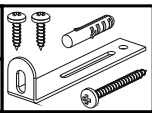
BT1-00408 Colli 1/2

B01-90		B02-170		B08-80	
6x	3,5x20	6x		1x	
B02-10		B02-20			
48x	ø15x12mm	48x			

BT1-00410 Colli 1/2

B05-20	
28x	



▶ SCAN ME

BT1-00409 Colli 2/2

B05-20	
8x	

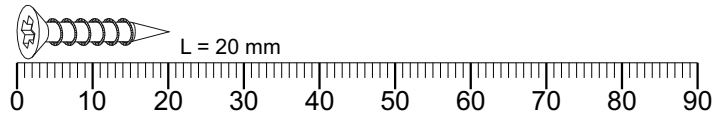

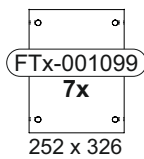
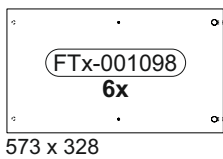

Colli 1/2

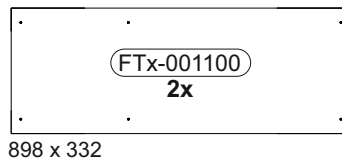
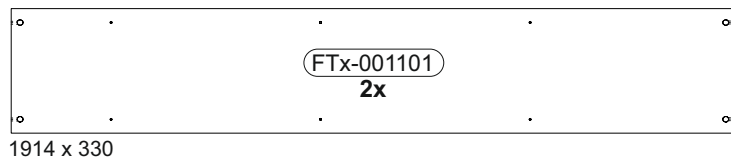

Colli 2/2



1	B02-10		B02-20	
	12x	ø15x12mm	24x	

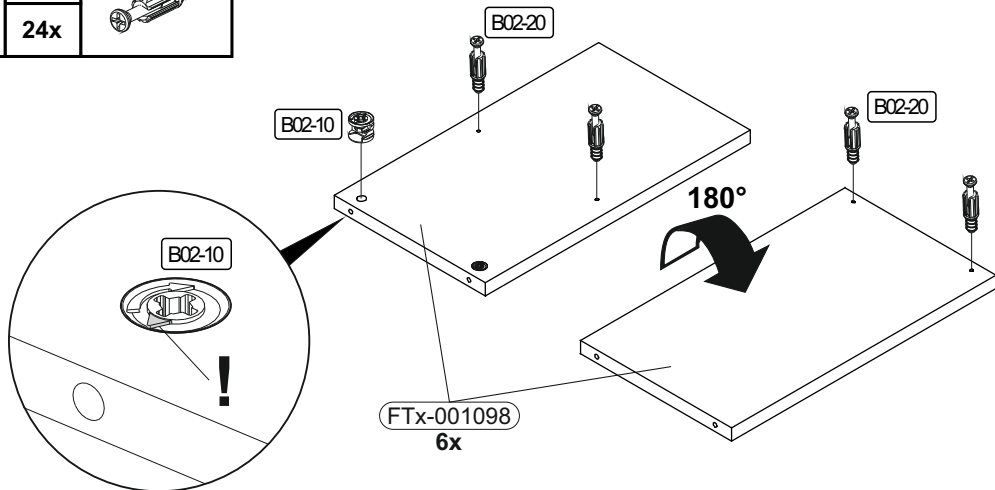

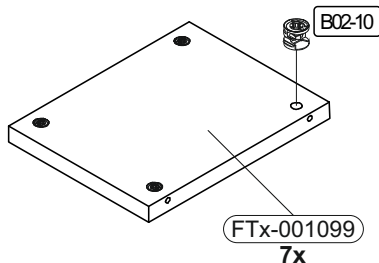

2	B02-10	
	28x	ø15x12mm



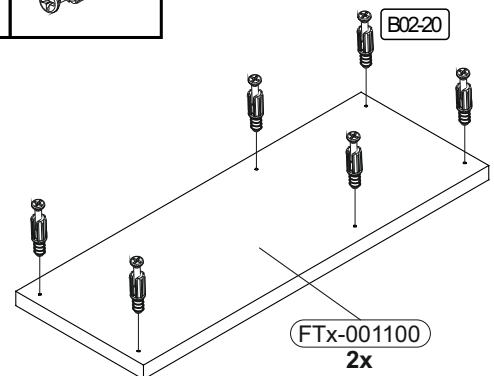

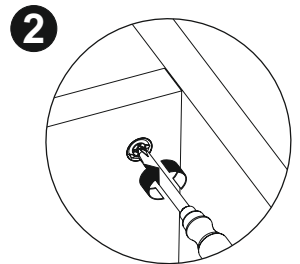
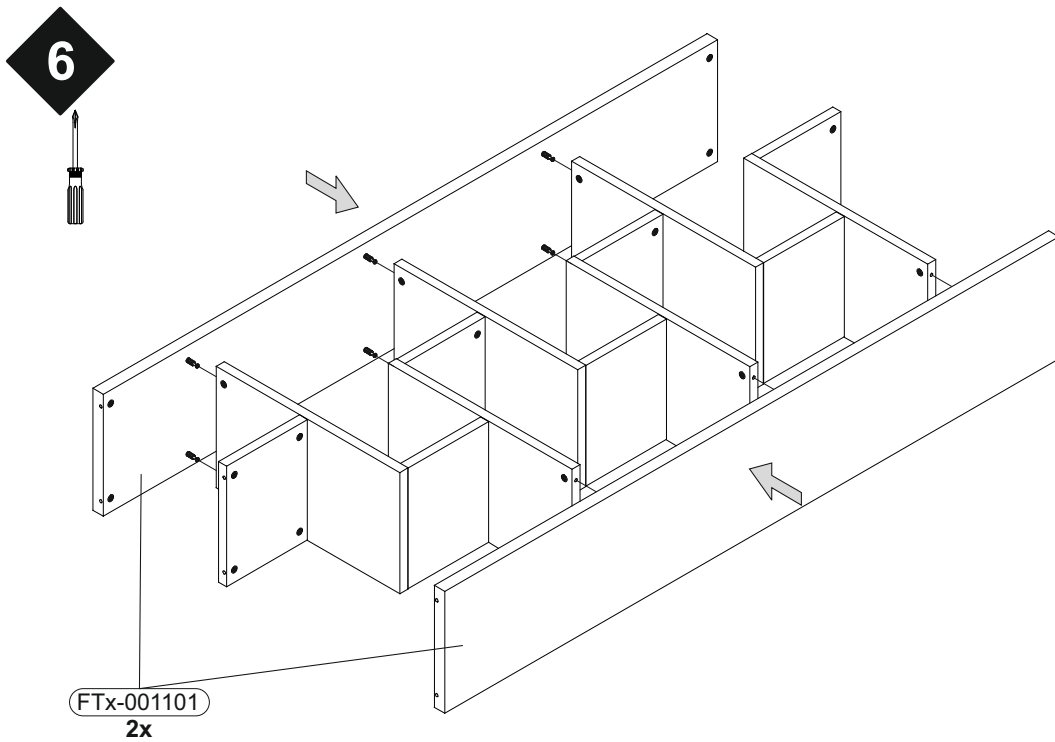
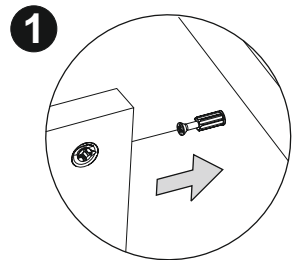
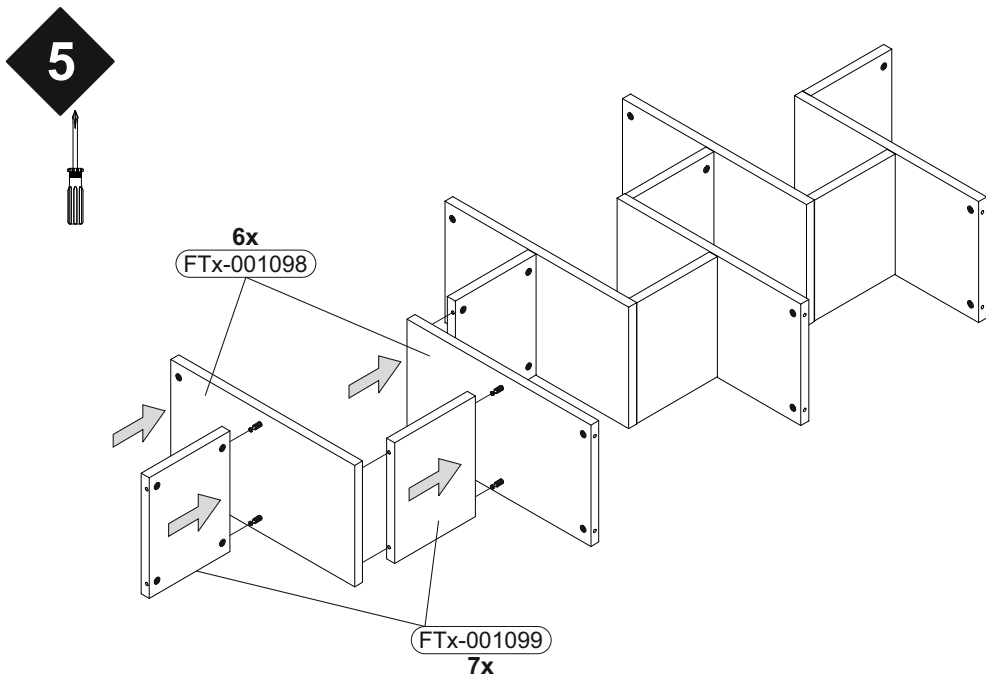
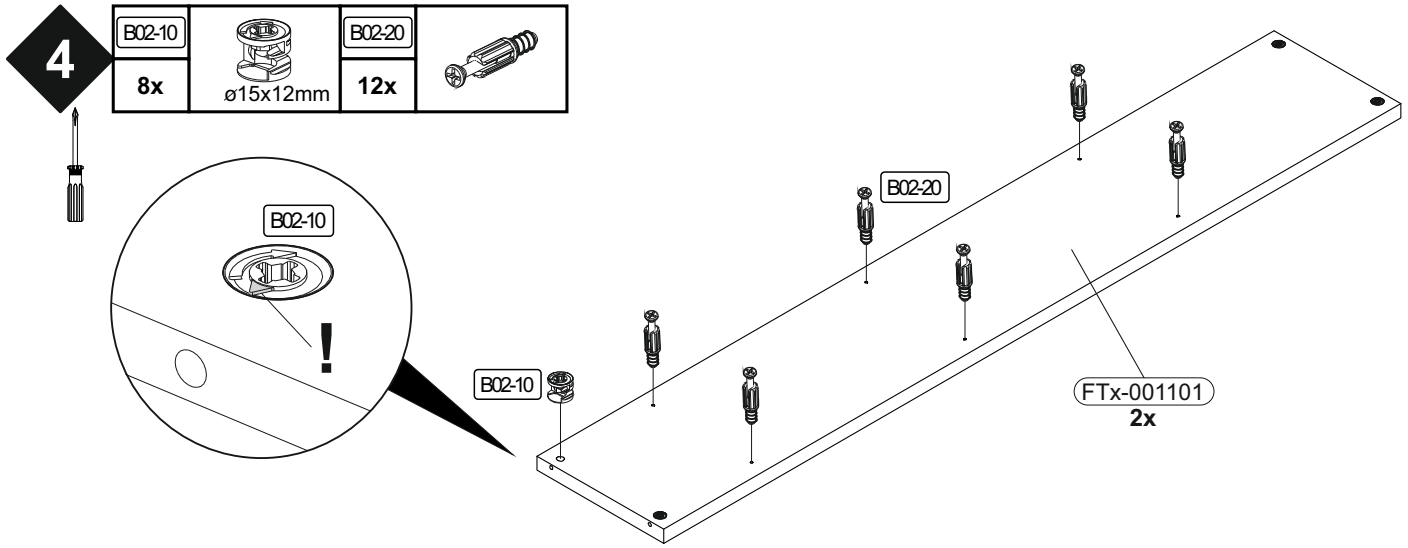
3	B02-20	
	12x	



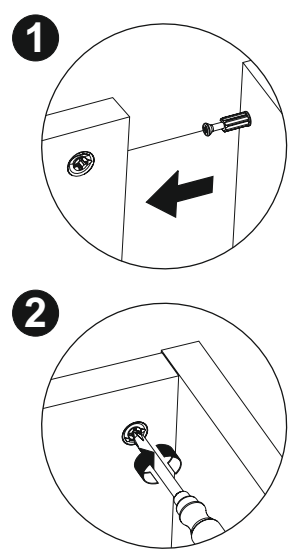
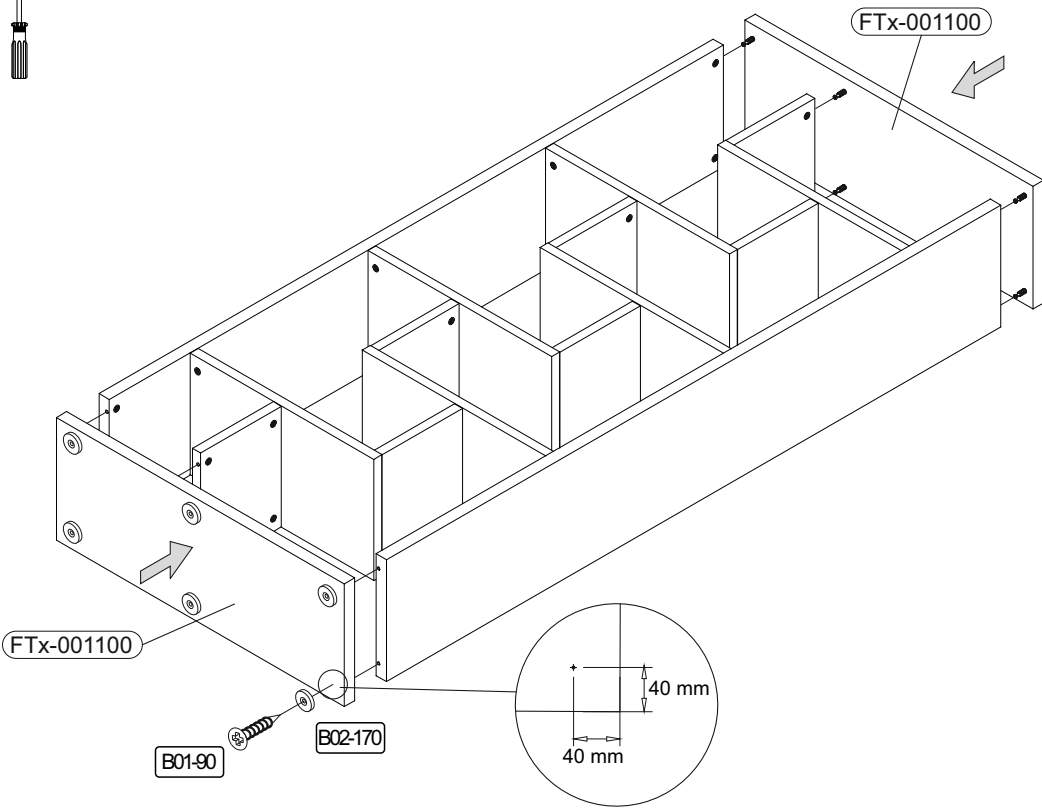

7	B01-90		B02-170	
	6x	3,5x20	6x	



8	B05-20	
	28x	
	B05-20	
	8x	

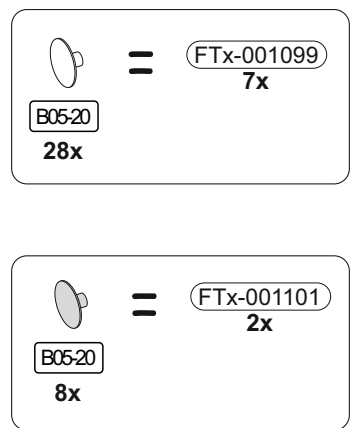
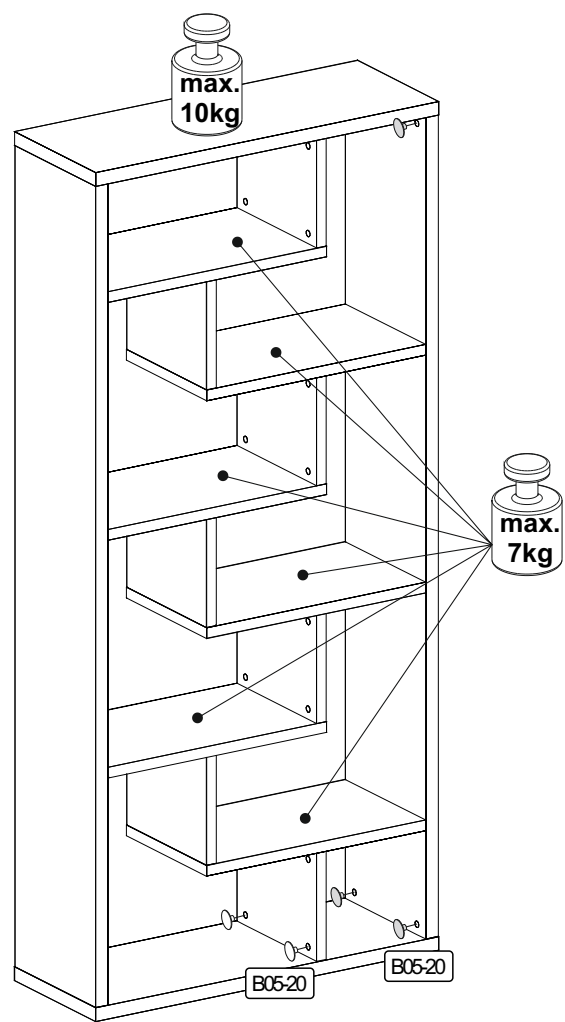

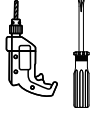
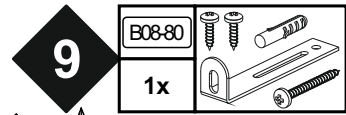

1



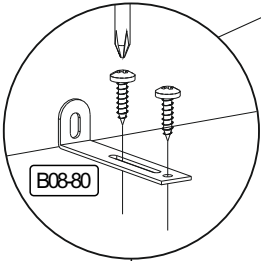

▶ SCAN ME

2

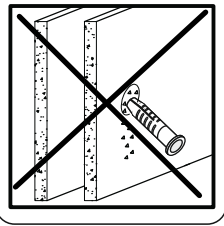
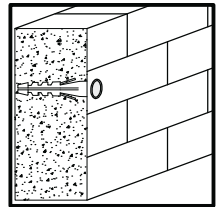
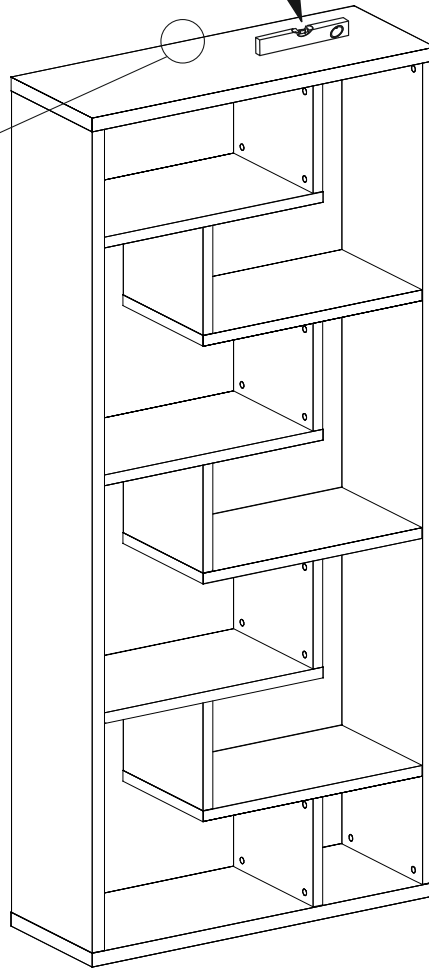
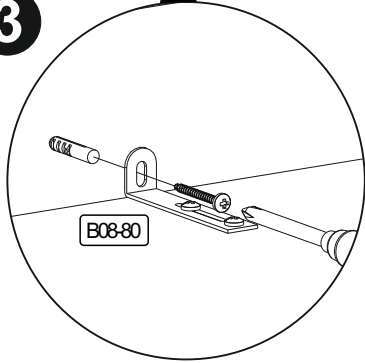

3



 Achtung • Attention • Attenzione • Opgelet • Uwaga • Pozor • Figyelem • Atenție • Dikkat • Внимание 	
(D)	Wandbefestigung dient als Kippschutz - unbedingt anbringen! Bei einigen Wandtypen kann ein Spezialdübel erforderlich sein!
(GB)	The wall fastening serves to prevent tipping - be absolutely sure to mount it! For certain wall types, a special wall plug may be necessary!
(FR)	La fixation murale sert de protection contre le basculement – à installer impérativement ! Pour certains types de murs il faut des chevilles spéciales !
(TR)	Duvardaki sabitleme, devrilmeye karşı bir emniyet tedbiridir ve mutlaka monte edilmelidir! Bazı duvar tiplerinde bunun için özel bir dübel gerekli olabilir!
(IT)	Il fissaggio alla parete serve da protezione anti-ribaltamento – attaccarla assolutamente! Per alcune strutture di parete può essere necessario un tassello speciale!
(NL)	Bevestiging aan de muur dient als kantelbescherming – zeker en vast bevestigen! Bij enkele muurtypes is een speciale plug misschien vereist!
(RU)	Обязательно установите крепление на стене во избежание опрокидывания! Для некоторых типов стен может потребоваться специальный дюбель!
(CZ)	Montáž na stěnu slouží jako ochrana proti převrnutí – bezpodmínečně umístěte! U některých typů stěn může být zapotřebí speciální hmoždinka!
(HU)	A terméket a falhoz kel rögzíteni, különben az felborulhat! Egyes faltípusoknál speciális tiplit kell használni!
(RO)	Sistemul de fixare la perete servește ca protecție la răsturnare - de montat obligatoriu! Pentru unele tipuri de perți este posibil să fie necesar un diblu special!
(PL)	Mocowanie do ściany jest jednocześnie zabezpieczeniem przed przewróceniem – koniecznie zamontować! Do niektórych rodzajów ścian konieczne zastosować specjalne kołki mocujące.
(SK)	Upevnenie na stenu slúži ako ochrana proti prevráteniu – bezpodmienečne použiť! Pre niektoré druhy stien môže byť potrebná špeciálna hmoždinka!