

3D - J

- PL Instrukcja montażu
- DE Montageanleitung
- NL Handleiding voor de montage
- TR Montaj talimatı
- FR Notice de montage
- CZ Montážní návod
- HU Szerelési útmutató
- GB Assembly instructions
- RU Инструкция по монтажу
- IT Istruzioni di montaggio
- SK Návod na montáž
- RO Instrucțiuni de montaj
- ES Instrucciones de montaje
- PT Instruções de montagem

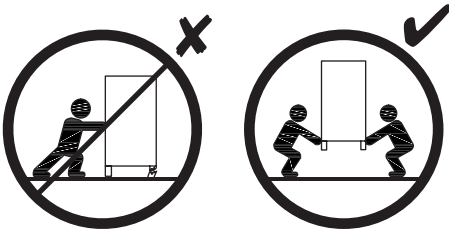
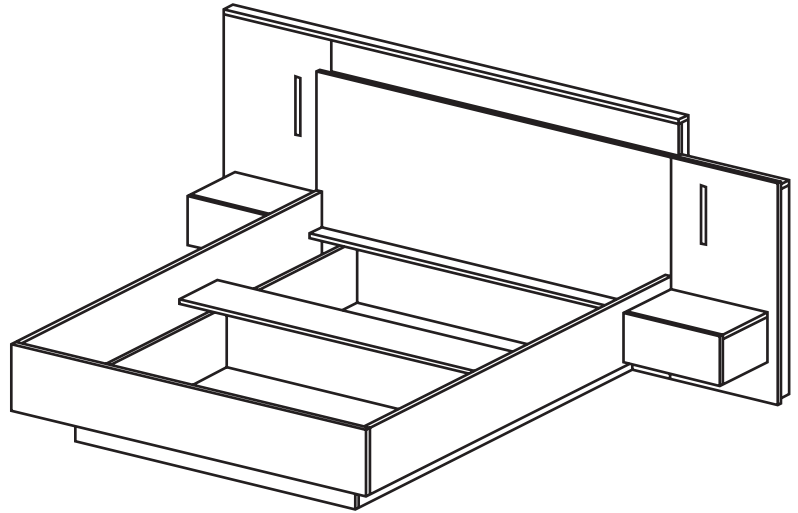

Producent - Produzent - Üretici - Producteur - Výrobce -
 Termező - Producer - Produttore - Producător - Productor
VENTE-UNIQUE.COM
 9/11 Rue Jacquard - 93310 - Le Pré Saint Gervais - France
 gpsr@vente-unique.com

2025-01-03



PL Przed rozpoczęciem montażu mebla wszystkie elementy należy sprawdzić czy nie są uszkodzone. W przypadku wykrycia uszkodzenia elementu należy odstąpić od montażu mebla i zgłosić reklamację.

Nie wolno przekraczać podanych maksymalnych wartości obciążenia. W innym przypadku można mebel uszkodzić lub zniszczyć.

Przed zawieszeniem mebla, lub przymocowaniem go do ściany (w celu zabezpieczenia przed przewróceniem), sprawdź wcześniej rodzaj i wytrzymałość ściany. Dobierz odpowiednie kołki i wkręty do rodzaju ściany. W przypadku wątpliwości skontaktuj się ze specjalistą. Montaż musi zostać wykonany przez osobę kompetentną.

Meble zawierające płyty drewnopochodne mogą emitować substancje zanieczyszczające do powietrza w pomieszczeniu. Dlatego zaleca się, po zamontowaniu mebli, częste wentrowanie pomieszczenia przez co najmniej cztery tygodnie.

DE Vor Beginn der Möbelmontage sollten alle Elemente auf Beschädigungen überprüft werden. Wenn ein Element des Produkts beschädigt ist, installieren Sie das Produkt bitte nicht und reichen Sie eine Beschwerde ein. Überschritten Sie die angegebenen Maximalbelastungen nicht. Andernfalls kann das Möbelstück beschädigt oder zerstört werden.

Bevor Sie ein Möbelstück an einer Wand aufhängen oder befestigen (um es gegen Umkippen zu sichern), prüfen Sie Art und Tragfähigkeit der Wand. Wählen Sie für die Wand geeigneten Dübel und Schrauben. Im Zweifelsfall kontaktieren Sie bitte einen Fachmann. Die Montage muss durch eine sachkundige Person ausgeführt werden.

Möbel mit Holzwerkstoffplatten können Schadstoffe in die Raumluft abgeben, daher Es wird empfohlen, den Raum nach dem Einbau der Möbel mindestens vier Wochen lang häufig zu lüften.

FR Avant de commencer l'assemblage du meuble, tous les éléments doivent être vérifiés pour détecter tout dommage. Si un élément du produit est endommagé, veuillez ne pas installer le produit et déposer une plainte.

Ne dépassez pas les charges maximum indiquées. Sinon, le meuble peut être endommagé ou détruit.

Avant de suspendre le meuble ou de le fixer au mur (dans le but d'éviter un renversement), vérifiez au préalable le type et la résistance du mur. Utilisez les chevilles et les vis adaptées au type de mur. En cas de doute, veuillez contacter un spécialiste. Le montage doit être réalisé par une personne compétente.

Les meubles contenant des panneaux à base de bois peuvent émettre des substances polluantes dans l'air intérieur. Donc Il est recommandé, après l'installation des meubles, d'aérer fréquemment la pièce pendant au moins quatre semaines.

CZ Před zahájením montáže nábytku je třeba zkontrolovat poškození všech prvků. Pokud je některý prvek produktu poškozen, zdržte se instalace produktu a podejte stížnost.

Nepřekračujte uvedená maximální zatížení. V opačném případě může dojít k poškození nebo zničení nábytku.

Před zavěšením nábytku nebo jeho připevněním ke zdi (za účelem zajištění před převrácením) dříve zkontrolujte druh a odolnost stěny. Vyberte k druhu stěny vhodné hmoždinky a šrouby. V případě pochybností kontaktujte specialistu. Montáž musí být provedena kompetentní osobou.

Nábytek obsahující panely na bázi dřeva může uvolňovat znečišťující látky do vnitřního ovzduší. Proto doporučuje se po instalaci nábytku místnost pravidelně větrat po dobu nejméně čtyř týdnů.

HU A bútorszerelés megkezdése előtt ellenőrizni kell az összes elem sérülését. Ha a termék bármely eleme megsérült, kérjük, tartózkodjon a termék telepítésétől és nyújtson be panaszt.

A megadott maximális terhelési értékeket nem szabad túllépni. Ellenkező esetben a bűtor megsérülhet vagy megsemmisülhet.

A bűtor felfüggesztése illetve falhoz való rögzítése (megakadályozván ezzel eldőlésének lehetőségét) előtt ellenőrizze a fal fajtáját és szilárdságát. Megfelelő, a falhoz illő tipiket és csavarokat használjon. Ha kétsége támadna, konzultáljon szakemberrel. A felszerelés csakis egy hozzáértő szakember végezheti el.

A fa alapú paneleket tartalmazó bútorkok szennyező anyagokat bocsáthatnak ki a beltéri levegőbe. Ezért Ajánlott a bútorkok beszerelése után legalább négy hétig rendszeresen szellőztetni a helyiséget.

GB Before starting the furniture assembly, all elements should be checked for damage. If any element of the product is damaged, please refrain from installing the product and file a complaint.

The specified maximum load values must not be exceeded. Otherwise, the piece of furniture may be damaged or destroyed.

Before suspending or fixing furniture to the wall (in order to prevent falling over), check the type and strength of the wall. Select wall plugs and screws appropriate for the given type of the wall. In the case of doubts, contact a specialist. The installation must be performed by a competent person.

Furniture containing wood-based panels can emit polluting substances into the indoor air. Therefore recommended, after installing the furniture, to ventilate the room frequently for at least four weeks.

SK Pred začatím montáže nábytku by sa mali skontrolovať všetky prvky, či nie sú poškodené. Ak je niektorý prvok výrobku poškodený, neinštalujte výrobok a reklamujte ho.

Uvedené hodnoty maximálneho zaťaženia nesmú byť prekročené. V opačnom prípade môže dôjsť k poškodeniu alebo zničeniu nábytku.

Pred zavesením nábytku alebo jeho pripavením na stenu (za účelom zaistenia pred prevrátením) predtým zkontrolujte druh a odolnosť steny. Vyberte k druhu steny vhodné hmoždinky a skrutky. V prípade pochybností kontaktujte špecialistu. Montáž musí byť vykonaná kompetentnou osobou.

Nábytek obsahujúci dosky na báze dreva môže vylučovať znečisťujúce látky do vnútorného ovzdušia. Preto odporúča sa po instalácii nábytku miestnosť pravidelne vetrať aspoň štyri týždne.

IT Prima di iniziare l'assemblaggio del mobile, tutti gli elementi dovrebbero essere controllati per danni. Se qualche elemento del prodotto è danneggiato, astenersi dall'installare il prodotto e presentare un reclamo.

I valori di carico massimo specificati non devono essere superati. In caso contrario, il mobile potrebbe essere danneggiato o distrutto.

Prima di appendere i mobili, oppure attaccarli al muro (per proteggerli da ribaltamenti), verifica prima la tipologia e resistenza del muro. Scegli i tasselli e viti più adatti per il tipo di muro. In caso di dubbi contattare uno specialista. Il montaggio deve essere fatto da una persona competente.

I mobili contenenti pannelli a base di legno possono emettere sostanze inquinanti nell'aria interna. Perciò si consiglia, dopo aver installato i mobili, di aerare frequentemente il locale per almeno quattro settimane.

NL Voordat u met de meubelmontage begint, moeten alle elementen op schade worden gecontroleerd. Als een onderdeel van het product beschadigd is, installeer het dan niet en dien een klacht in.

Overschrijd de aangegeven maximale belastingen niet. Anders kan het meubelstuk worden beschadigd of vernield.

Voordat u het meubel ophangt of bevestigt tegen de muur (om het te beschermen tegen omvallen) dient u het type en de duurzaamheid van deze muur na te kijken. Maak gebruik van pluggen en schroeven die geschikt zijn voor het type muur. Neem in geval van twijfel contact op met een specialist. De assemblage dient te worden uitgevoerd door iemand met kennis van zaken.

Meubels met panelen op houtbasis kunnen vervuulende stoffen in de binnenlucht uitstoten. Daarom Het is raadzaam om na het plaatsen van het meubilair de ruimte minimaal vier weken regelmatig te ventileren.

TR Mobilya montajına başlamadan önce tüm elemanlarda hasar olup olmadığını kontrol edilmelidir. Ürünün herhangi bir parçası hasar görmüşse, lütfen ürünü kurmayız ve şikayette bulunun.

Belirtilen azami yük degerini aşmayınız, aksi takdirde mobilya parçaları zarar görebilir veya kullanılamaz hale gelebilir.

Mobilyayı duvara asmadan veya montaj etmeden önce (devrilmesini önlemek için) duvarın türünü ve dayanıklılığını kontrol edin. Duvara uygun dübelleri ve vidaları seçin. Emin olamamanız durumunda bir uzman ile iletişime geçin.

Kurulum yetkili bir kişi tarafından yapılmalıdır. Aşşap bazlı paneller içeren mobilyalar için mekan havasına kirletici maddeler yayabilir. Öyleyse Mobilyaların kurulumundan sonra odanın en az dört hafta boyunca sık sık havalandırılması önerilir.

RO Înainte de a începe asamblarea mobilierului, toate elementele trebuie verificate pentru a nu se deteriora. Dacă vreun element al produsului este deteriorat, vă rugăm să vă abțineți de la instalarea produsului și să depuneți o reclamație.

Valorile maxime de sarcină specificate nu trebuie depășite. În caz contrar, piesa de mobilier poate fi deteriorată sau distrusă.

Înainte de suspendarea unei piese de mobilier sau atașarea acestuia la perete (pentru a preveni bascularea), verificați în prealabil tipul și gradul de rezistență a peretelui. Montați diblurile și șuruburile adecvate pentru tipul de perete. În caz de îndoieli, consultați un specialist. Instalarea trebuie să fie efectuată de către o persoană competentă.

Mobilierul care conține panouri pe bază de lemn poate emite substanțe poluante în aerul interior. Prin urmare se recomandă ca, după montarea mobilierului, aerisirea frecventă a încăperii timp de cel puțin patru săptămâni.

ES Antes de comenzar el montaje de los muebles, todos los elementos deben comprobarse en busca de daños. Si algún elemento del producto está dañado, absténgase de instalar el producto y presente una queja.

No se deben exceder los valores de carga máxima especificados. De lo contrario, el mueble puede dañarse o destruirse.

Antes de colgar o fijar el mueble en el muro (a fin de proteger contra el vuelco del mueble), compruebe de antemano la naturaleza y la resistencia de la pared. Seleccione tacos y tornillos adecuados para el tipo de la pared. En caso de duda, consulte a un especialista, debiendo efectuar este montaje una persona competente.

Los muebles que contienen paneles de madera pueden emitir sustancias contaminantes al aire interior. Por lo tanto se recomienda, después de instalar los muebles, ventilar la habitación con frecuencia durante al menos cuatro semanas.

PT Antes de iniciar a montagem do móvel, todos os elementos devem ser verificados quanto a danos. Se algum elemento do produto estiver danificado, evite instalar o produto e apresente uma reclamação.

Os valores de carga máxima especificados não devem ser excedidos. Caso contrário, o móvel pode ficar danificado ou destruído.

Antes de suspender ou fixar móveis à parede (para evitar quedas), verifique o tipo e a resistência da parede. Selecione buchas e parafusos adequados ao tipo de parede. Em caso de dúvida contacte um especialista. A instalação deve ser realizada por uma pessoa competente.

Os móveis que contenham painéis de madeira podem emitir substâncias poluentes para o ar interior. Assim, recomendamos-se, após a instalação dos móveis, ventilar o ambiente frequentemente durante pelo menos quatro semanas.

RU Прежде чем приступить к сборке мебели, следует проверить все элементы на предмет повреждений. Если какой-либо элемент продукта поврежден, воздержитесь от установки продукта и подайте жалобу.

Указанные максимальные значения нагрузки превышать нельзя. В противном случае предмет мебели может быть поврежден или разрушен.

Прежде чем подвешивать или крепить мебель к стене (во избежание падения), проверьте тип и прочность стены. Выбирайте дюбели и шурупы, подходящие для данного типа стены. В случае сомнений обратитесь к специалисту. Установка должна выполняться компетентным лицом.

Мебель, состоящая из древесных плит, может выделять загрязняющие вещества в воздух в помещении. Поэтому рекомендуется после установки мебели часто проветривать помещение в течение как минимум четырех недель.

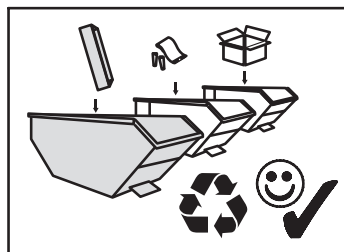
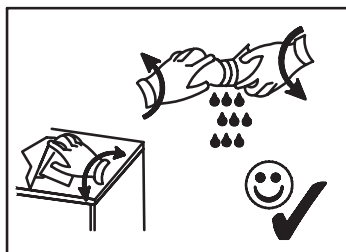
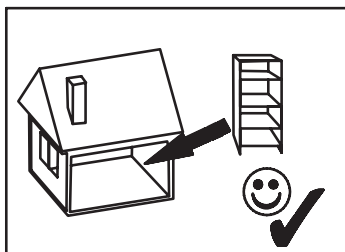
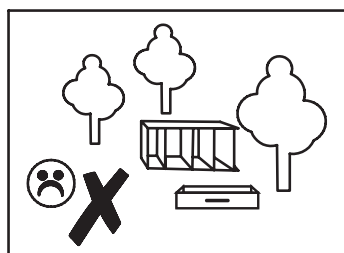
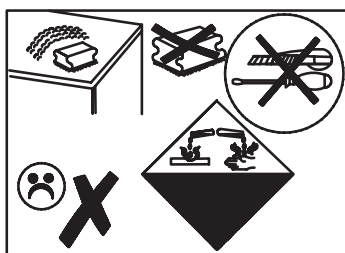
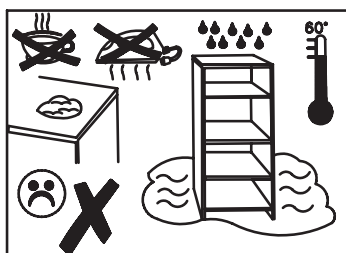
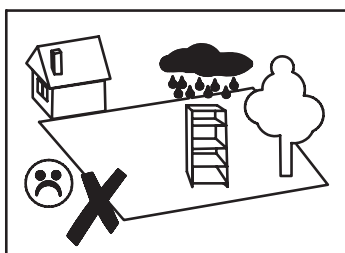

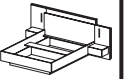

A 7 x 50 mm x 20	B 8 x 32 mm x 85	E2 3 x 20 mm x 68	E5 4 x 16 mm x 32	EE2 x 10	G2 x 19	K L=250 mm x 2	O1 x 10
O2 x 2	QB x 10	R H=11 mm x 58	R1 H=15 mm x 4	RA x 4	RB x 8	RRA H=16 mm x 4	RRB 6 x 55 x 8
RRC H=13 mm x 4	T3 5 x 9 mm x 12	U L=24,3 mm x 52	U6 L=54 mm x 5	W9 x 4	XA 4 mm x 1	XB 6 mm x 1	ZR Ø 15 x 62
LED x 1							

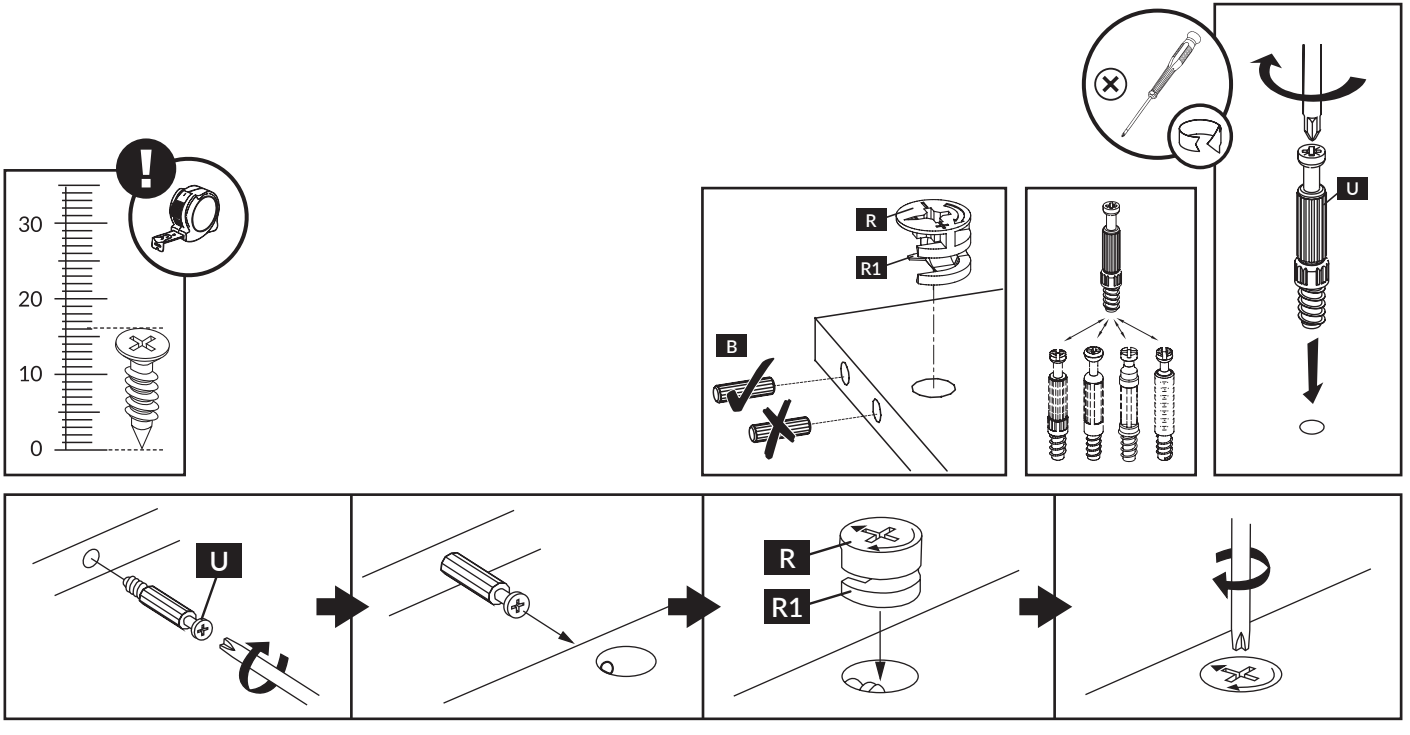



DE Nicht enthalten, separat erhältlich.

Die Struktur des Bettes ist an die Installation der vom Hersteller empfohlenen Rahmen angepasst: Holz mit Rahmen oder Metall mit Gasfeder. Der Hersteller haftet nicht für Schäden oder Gesundheitsschäden, die durch die Verwendung eines anderen als dem empfohlenen Gestells verursacht werden.

NL Niet inbegrepen, apart verkrijgbaar.

De structuur van het bed is aangepast aan de installatie van de frames die door de fabrikant worden aanbevolen: van hout met een frame of van metaal met een gasveer. De fabrikant is niet verantwoordelijk voor schade of gezondheidsschade veroorzaakt door het gebruik van een ander rek dan aanbevolen.

TR Dahil değildir, ayrı satılır.

Yatağın yapısı, üretici tarafından önerilen çerçevelerin kurulumuna uyarlanmıştır: çerçevesiz ahşap veya gaz asansörlü metal. Üretici, önerilenden farklı bir rafın kullanımından kaynaklanan hasar veya sağlığa zarardan sorumlu değildir.

FR Non inclus, vendu séparément.

La structure du lit est adaptée à l'installation des cadres préconisés par le fabricant : bois avec cadre ou métal avec vérin à gaz. Le fabricant n'est pas responsable des dommages ou des atteintes à la santé causés par l'utilisation d'un rack autre que celui recommandé.

CZ Není součástí, prodává se samostatně.

Konstrukce postele je přizpůsobena montáži rámu doporučených výrobcem: dřevěné s rámem nebo kovové s plynovým zdvihem. Výrobce nenes odpovědnost za poškození nebo zdravotní újmu způsobenou použitím jiného než doporučeného regálu.

HU Nem tartozék, külön eladó.

Az ágy szerkezete a gyártó által javasolt keretek beépítéséhez igazodik: fa kerettel vagy fém gázlifttel. A gyártó nem vállal felelősséget az olyan károkért vagy egészségkárosodásért, amelyet az ajánlottól eltérő rack használata okozott.

GB Not included, sold separately.

The structure of the bed is adapted to the installation of the frames recommended by the manufacturer: wooden with a frame or metal with a gas lift. The manufacturer is not responsible for damage or health detriment caused by the use of a frame other than recommended.

PL Brak w zestawie, sprzedawane osobno.

Konstrukcja łóżka dostosowana jest do zamontowania, zalecanych przez producenta stelaży: drewnianego z ramką lub metalowego z podnośnikiem gazowym. Producent nie ponosi odpowiedzialności za uszkodzenia czy uszczerbek na zdrowiu spowodowane wykorzystaniem stelaża innego niż zaleca.

IT Non incluso, venduto separatamente.

La struttura del letto si adatta all'installazione dei telai consigliati dal produttore: in legno con telaio o in metallo con alzata a gas. Il produttore non è responsabile per danni o danni alla salute causati dall'uso di un rack diverso da quello raccomandato.

SK Nie je súčasťou dodávky, predáva sa samostatne.

Konstrukcia postele je prispôbena montáži rámov odporúčaných výrobcem: drevené s rámom alebo kovové s plynovým zdvihom. Výrobca nezodpovedá za poškodenie alebo ujmu na zdraví spôsobenú použitím iného než odporúčaného regálu.

RO Nu este inclus, se vinde separat.

Structura patului este adaptată la montarea ramelor recomandate de producător: lemn cu cadru sau metal cu lift pe gaz. Producătorul nu este responsabil pentru daunele sau prejudiciile sănătății cauzate de utilizarea unui suport diferit de cel recomandat.

ES No incluido, se vende por separado.

La estructura de la cama se adapta a la instalación de los marcos recomendados por el fabricante: madera con marco o metal con pistón a gas. El fabricante no se responsabiliza de los daños o perjuicios para la salud causados por el uso de una rejilla diferente a la recomendada.

PT Não incluído, vendido em separado.

A estrutura da cama está adaptada para montar caixilharias recomendadas pelo fabricante: madeira com moldura ou metálica com elevador a gás. O fabricante não se responsabiliza por danos ou danos para a saúde causados pela utilização de uma moldura diferente da recomendada.

RU Не входит в комплект, продается отдельно.

Конструкция кровати приспособлена для установки каркасов, рекомендованных производителем: деревянных с каркасом или металлических с газлифтом. Производитель не несет ответственности за ущерб или вред здоровью, возникший в результате использования рамы, отличной от рекомендованной.

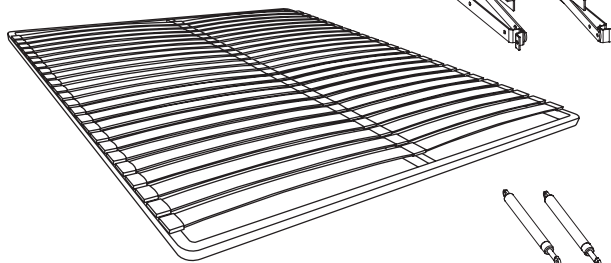

A

C

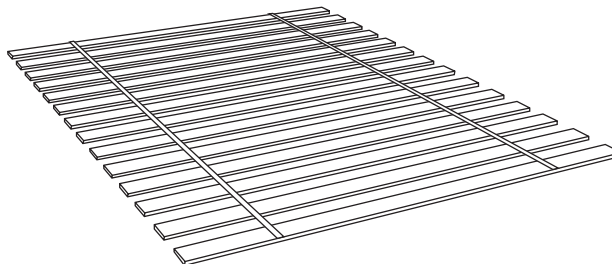
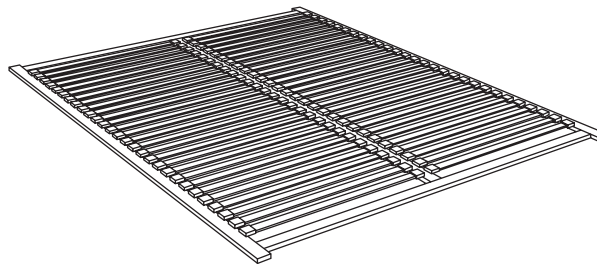



nr	↔ [mm]	↓ [mm]	∅ [mm]	Menge	Colli
J-1	900	1444	16	x 1	1/2
J-2	1912	100	16	x 1	2/2
J-3	852	100	16	x 1	1/2
J-4	852	100	16	x 1	2/2
J-5	852	100	16	x 2	1/2
J-6	1000	44	16	x 1	2/2
J-7	1000	44	16	x 1	2/2
J-8	132	1412	16	x 1	2/2
J-9	1912	60	16	x 1	2/2
J-10	1000	500	16	x 1	1/2
J-11	900	500	16	x 1	1/2
J-12	418	300	16	x 1	1/2
J-13	450	300	16	x 2	2/2
J-14	184	300	16	x 1	2/2
J-15	184	300	16	x 1	2/2
J-16	184	300	16	x 1	2/2
J-17	184	300	16	x 1	2/2

nr	↔ [mm]	↓ [mm]	∅ [mm]	Menge	Colli
J-18	1400	80	16	x 1	1/2
J-19	1400	250	16	x 1	1/2
J-20	1400	250	16	x 1	1/2
J-21	1445	272	22	x 1	2/2
J-22	1922	270	22	x 1	2/2
J-23	1922	270	22	x 1	2/2
J-24	1101	250	16	x 1	1/2
J-25	1068	250	16	x 1	1/2
J-26	1750	250	16	x 1	2/2
J-27	1750	250	16	x 1	2/2
J-28	1096	902	3	x 1	1/2
J-29	446	196	16	x 2	1/2
J-30	361	120	16	x 2	2/2
J-31	250	120	16	x 2	2/2
J-32	250	120	16	x 2	2/2
J-33	392	256	3	x 2	1/2

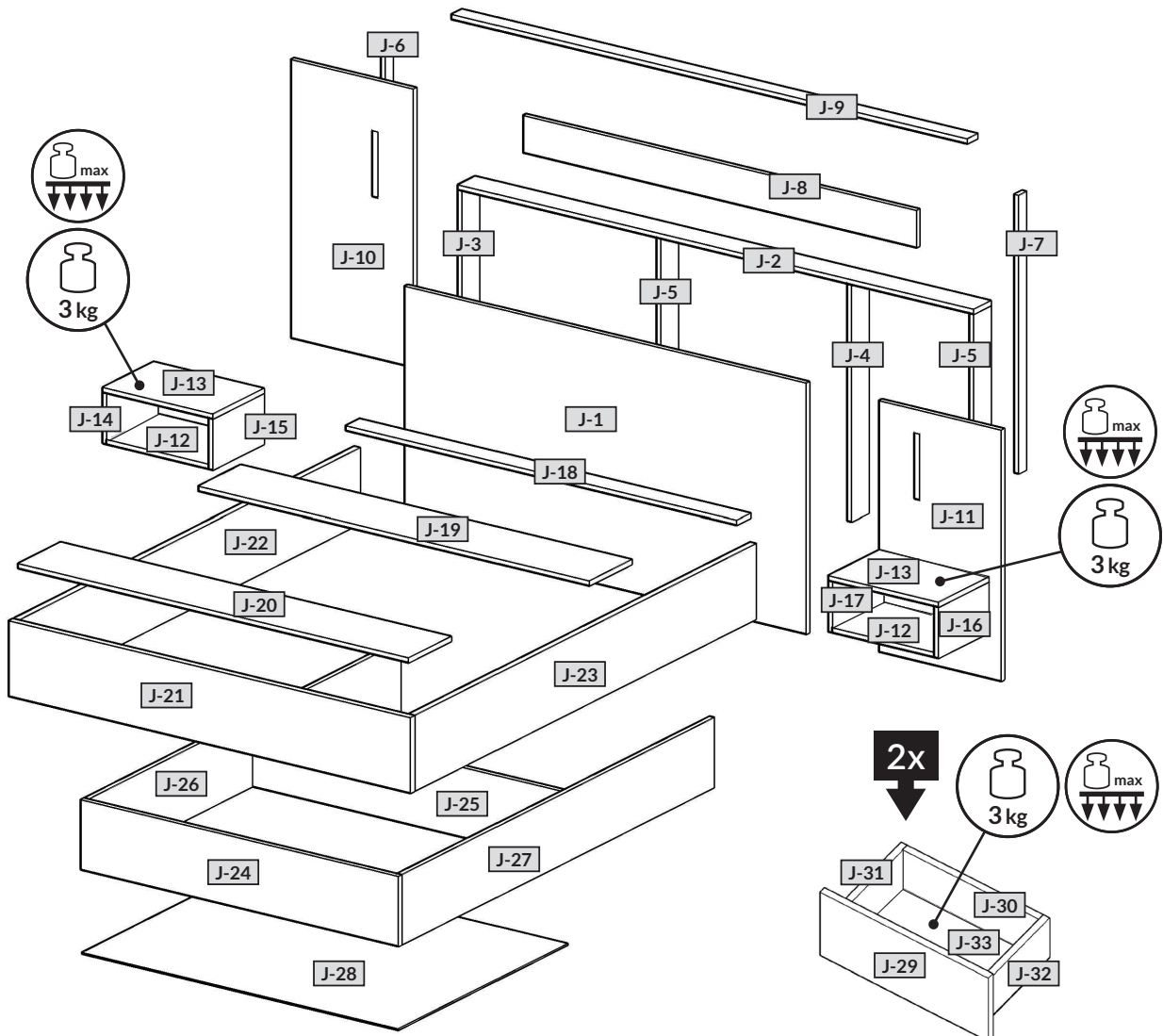



1

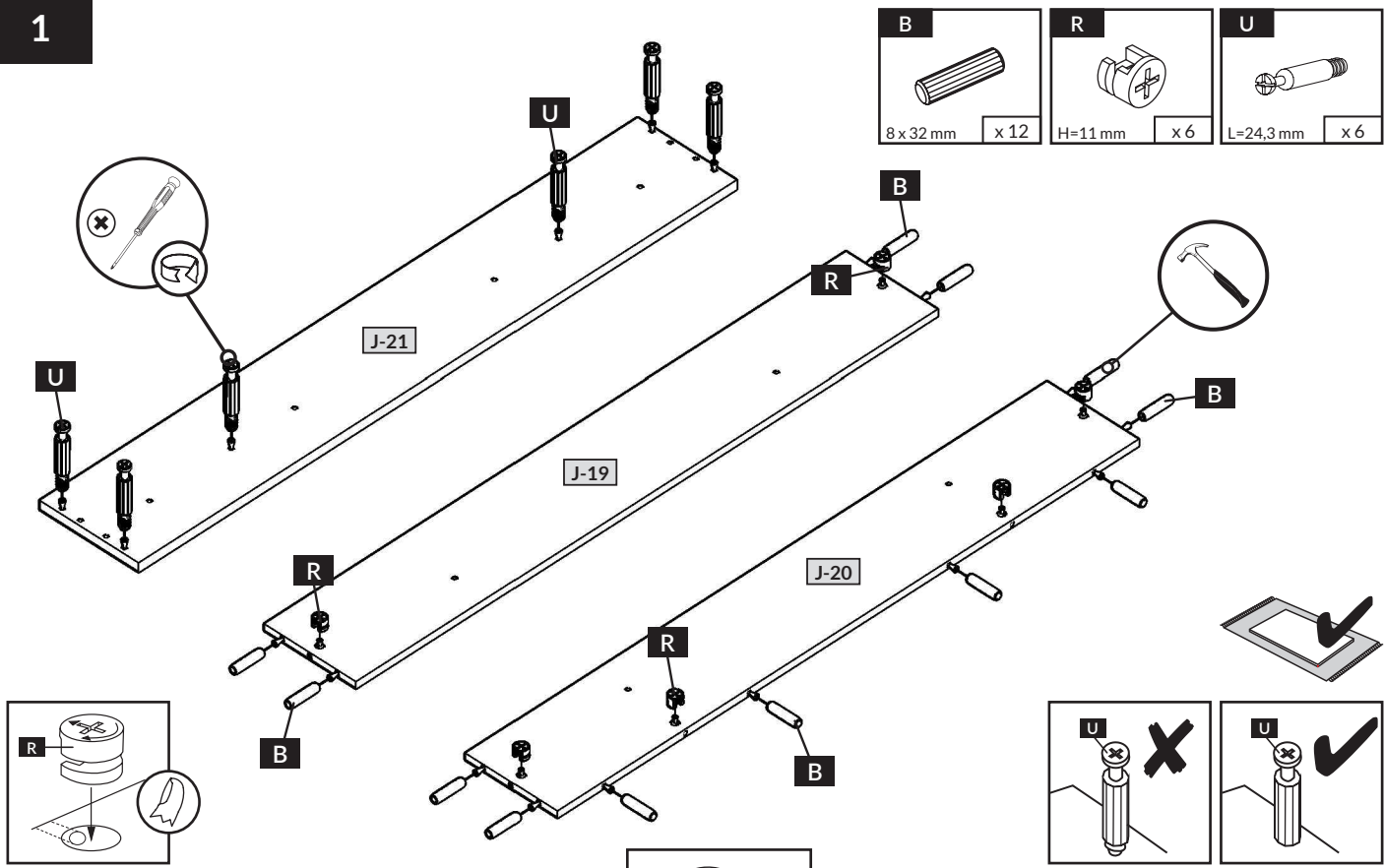

2

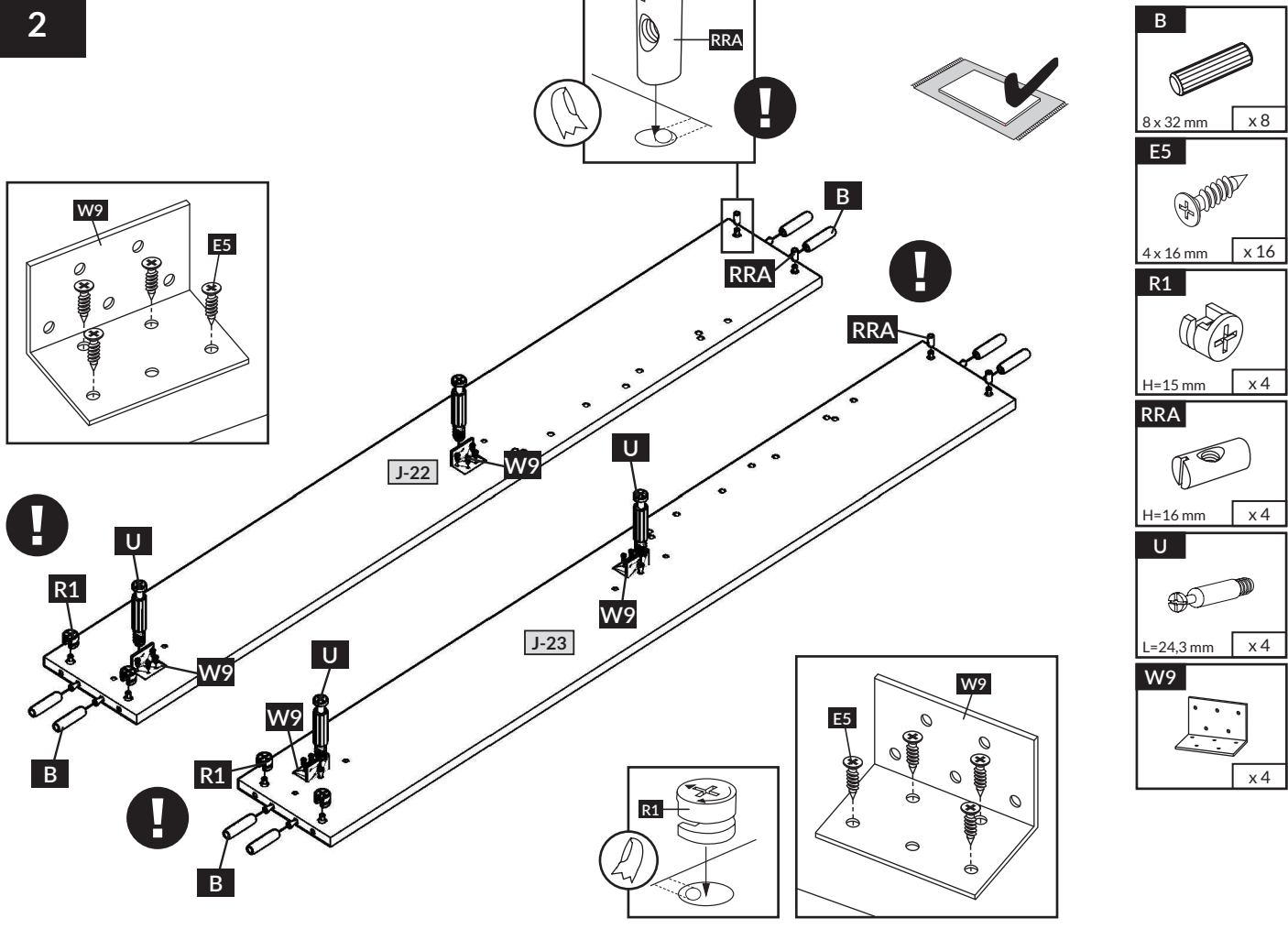

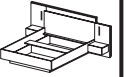

3

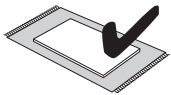
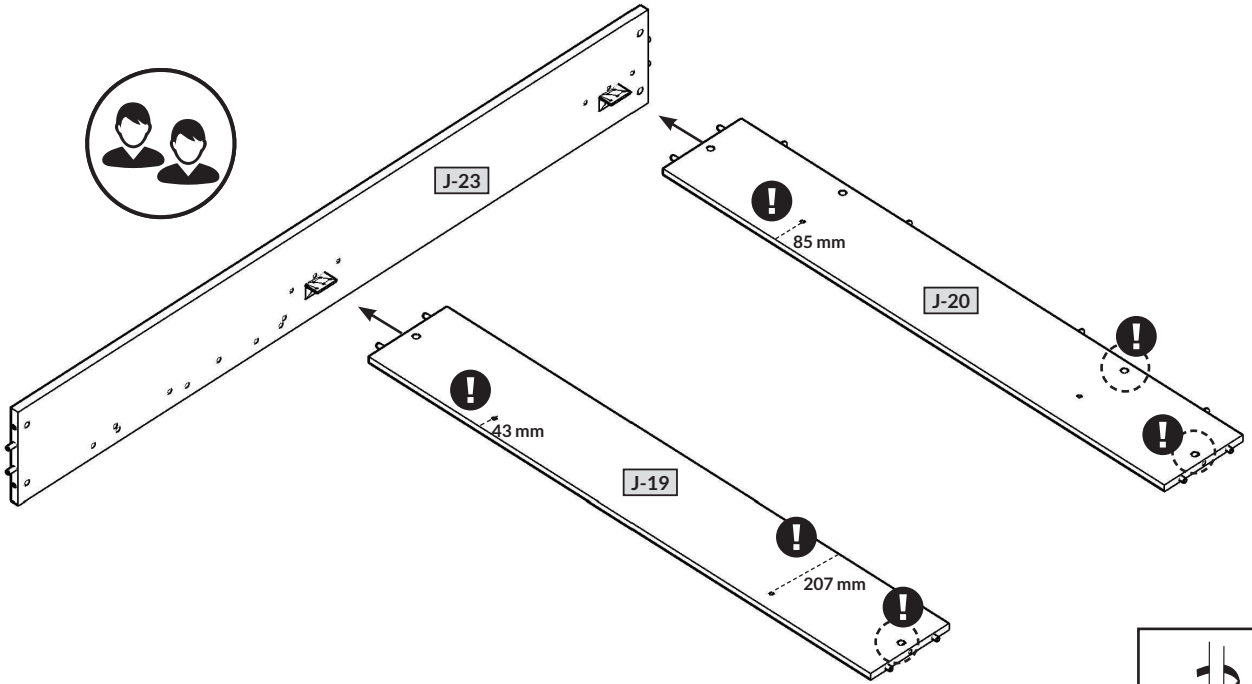

4

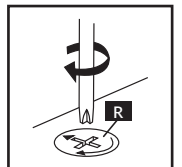
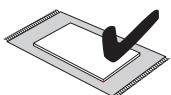
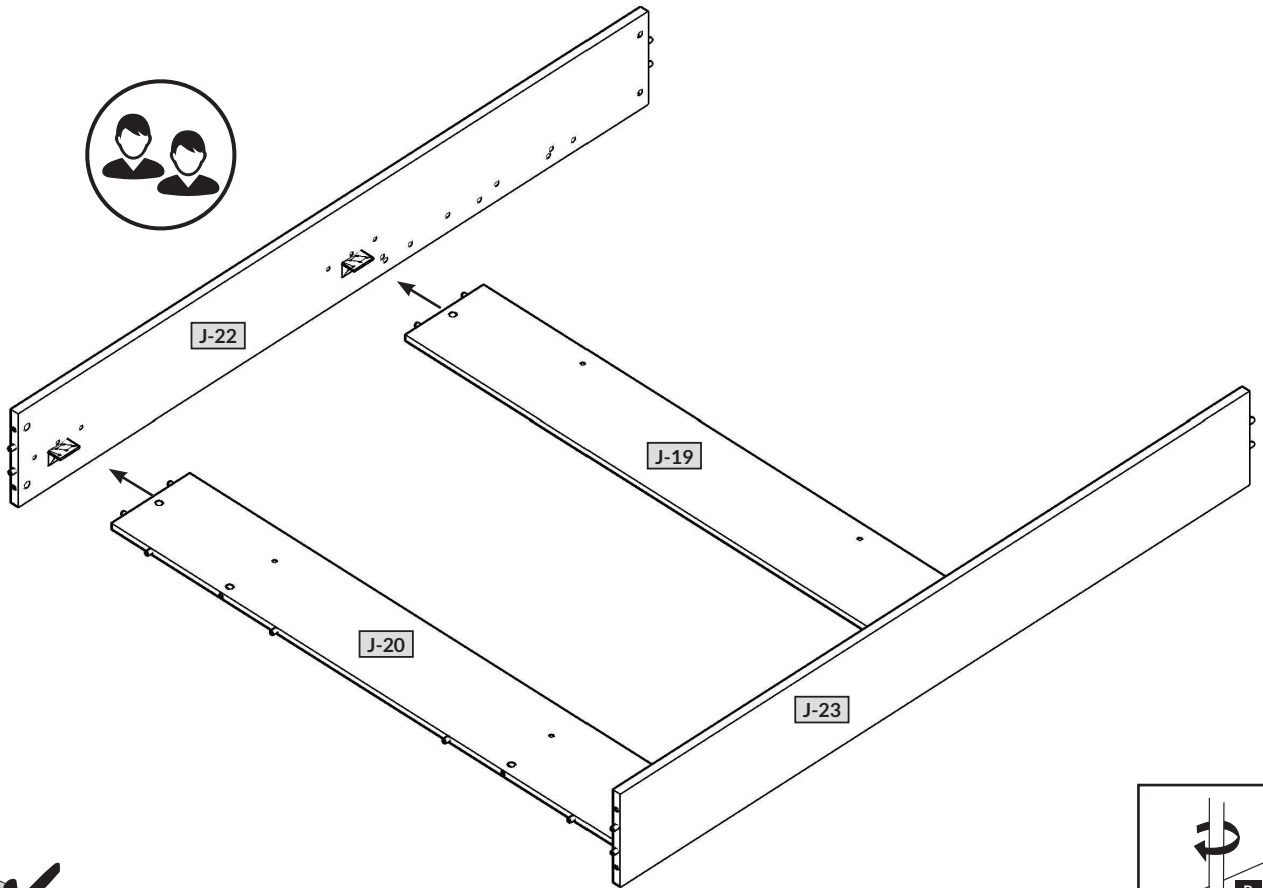

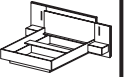

5

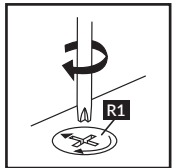
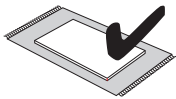
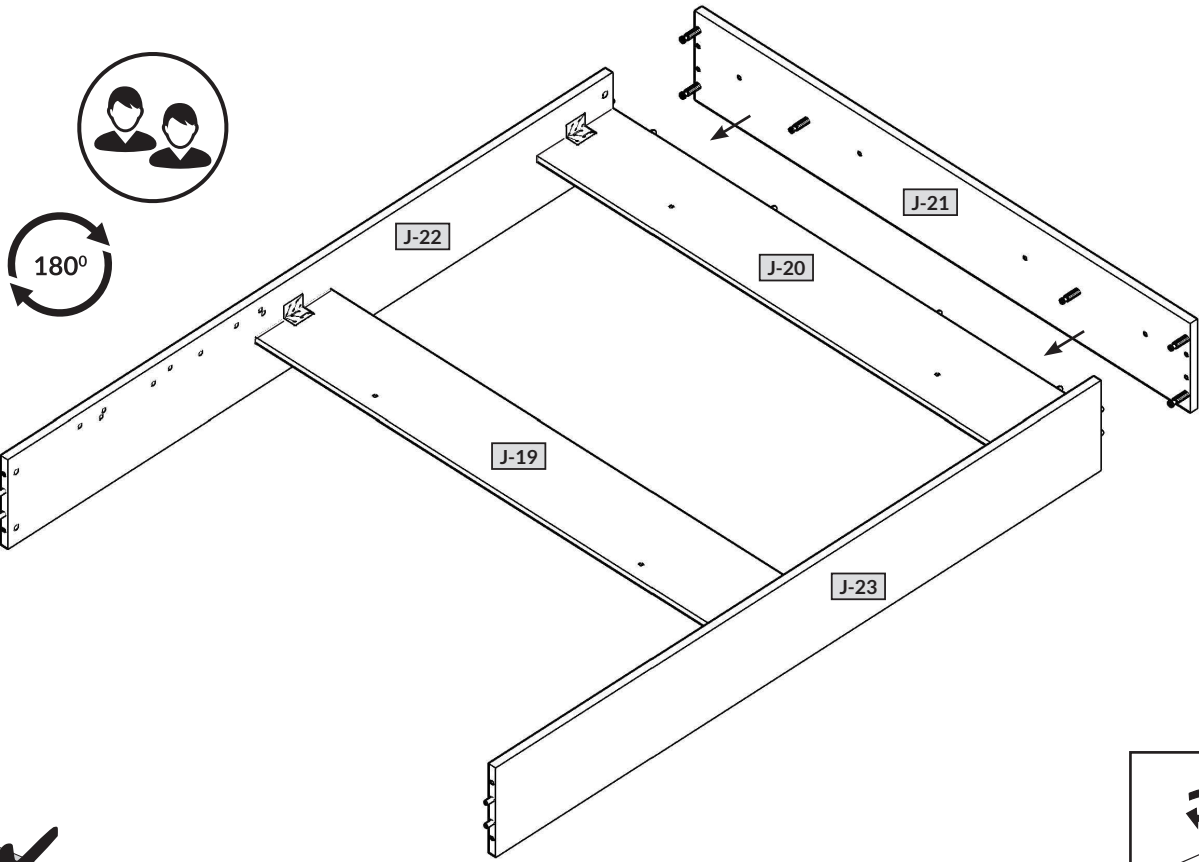

6

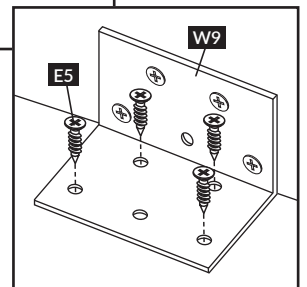
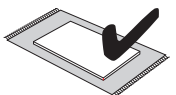
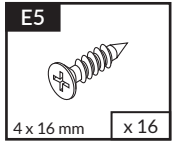
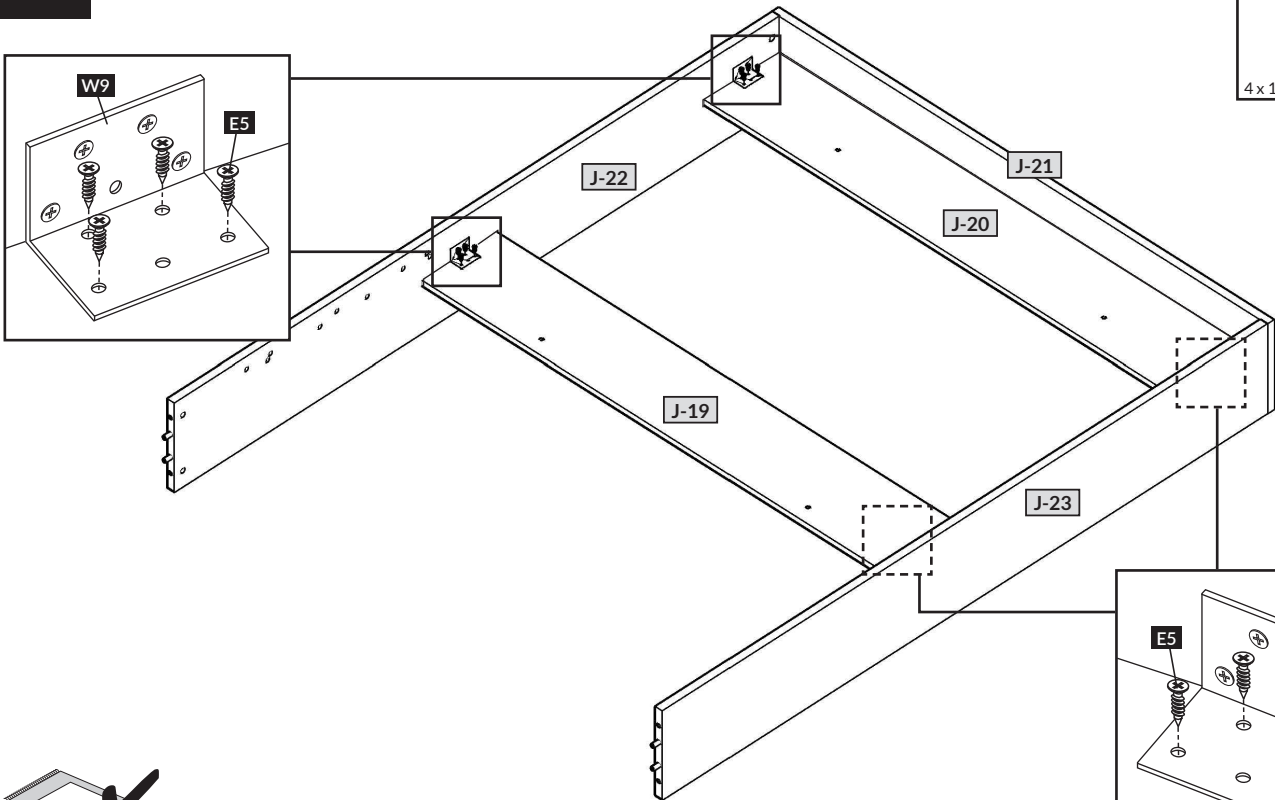



7

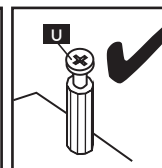
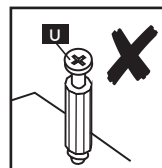
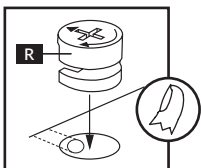
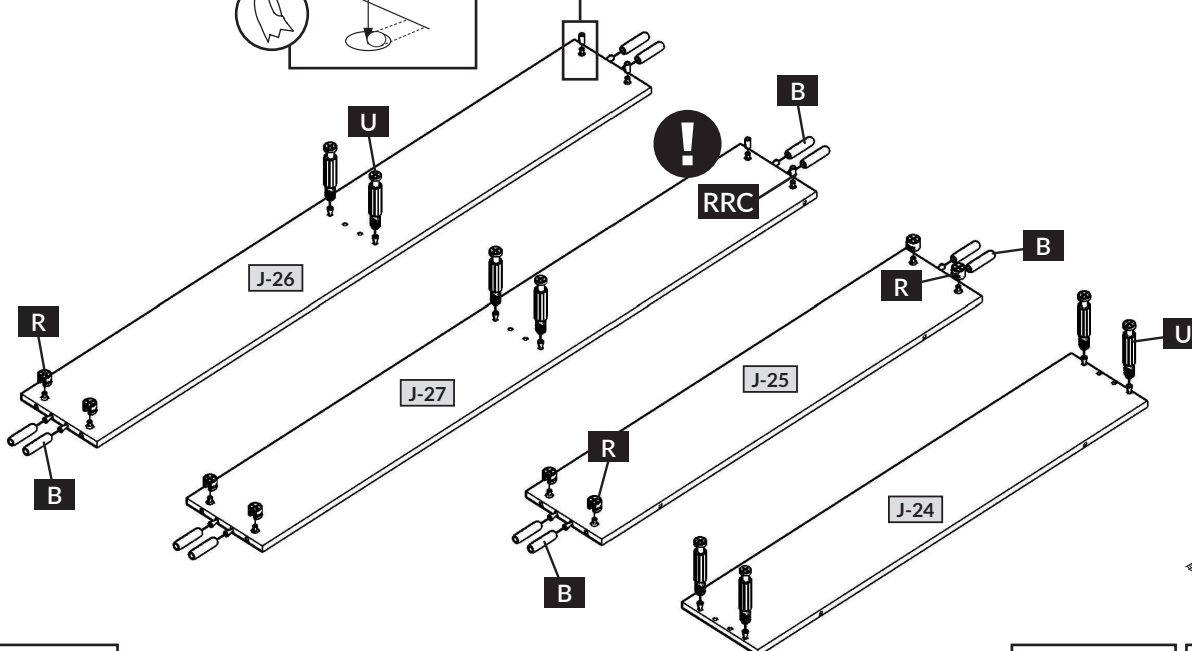
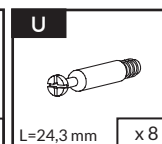
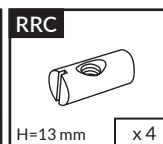
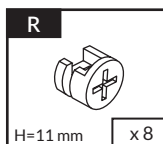
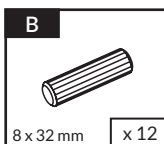
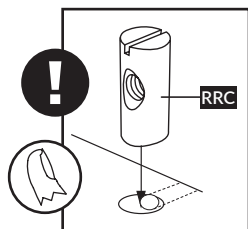

8

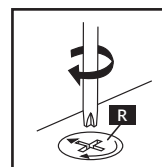
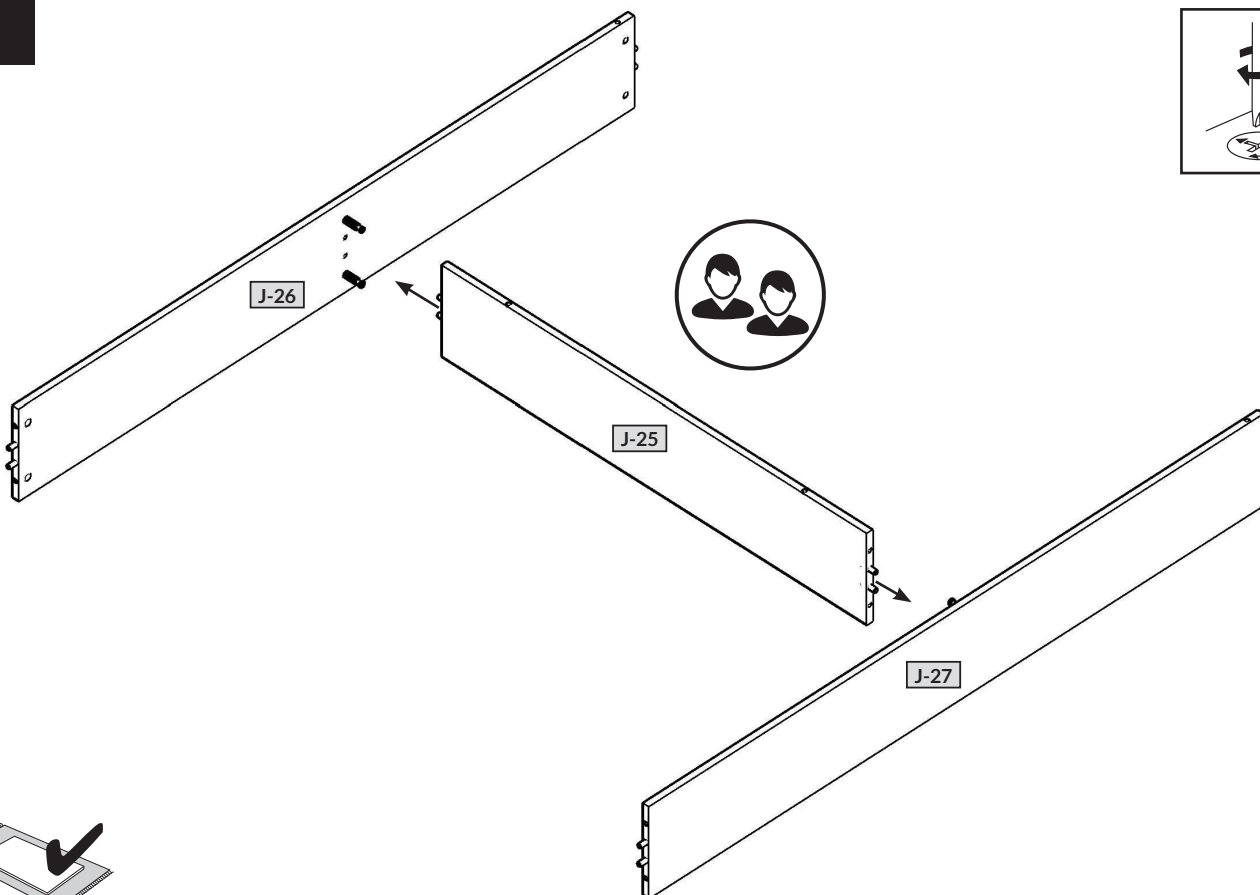

10

3D - J

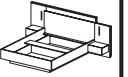

9

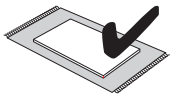
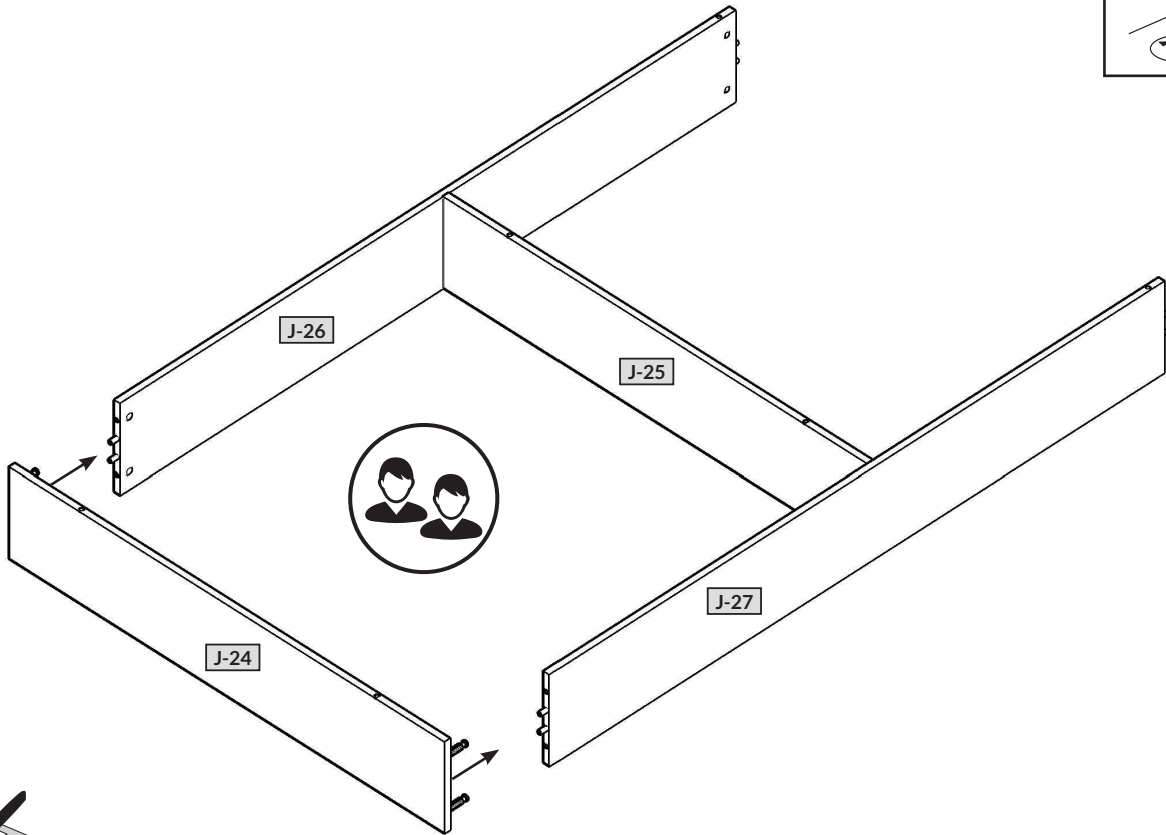

10

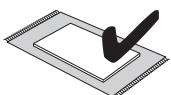
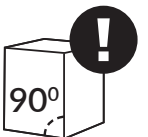
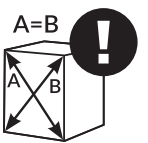
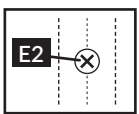
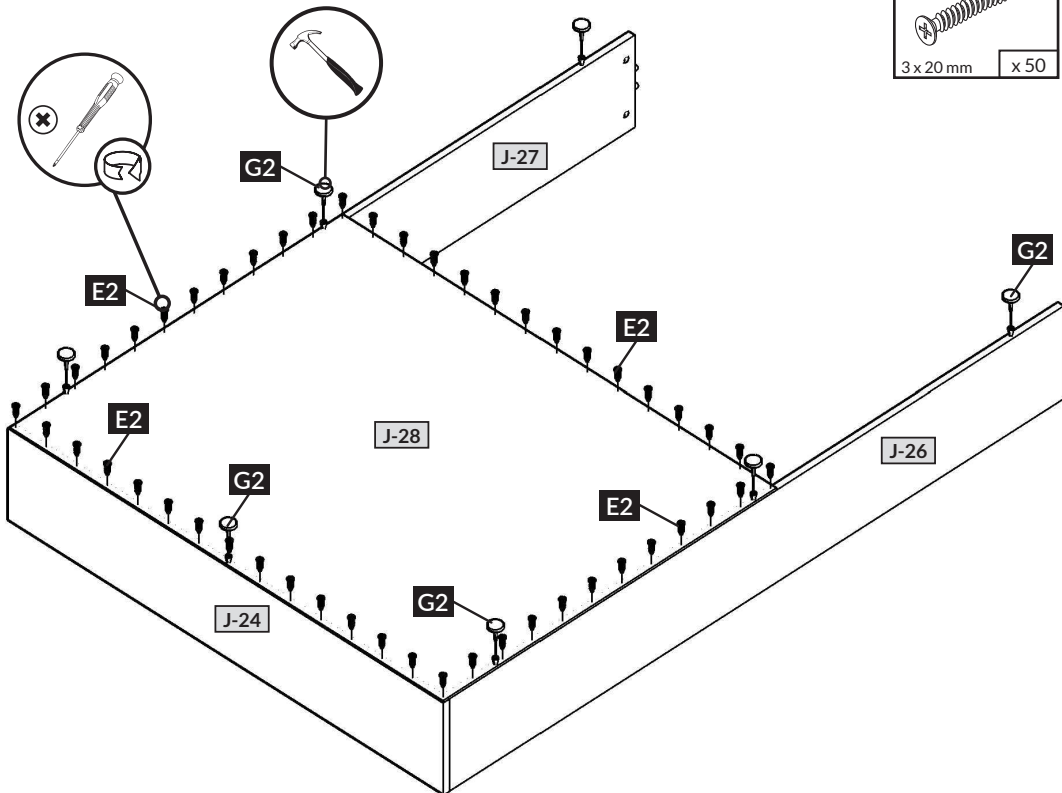
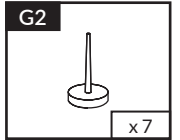
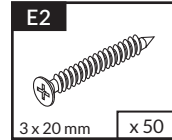

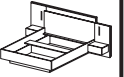

11

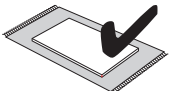
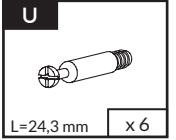
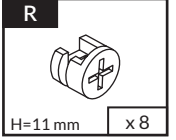
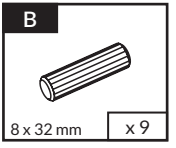
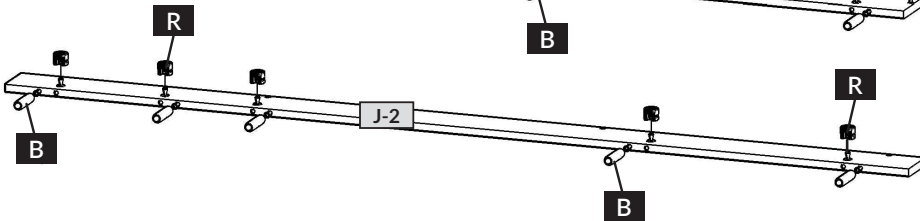
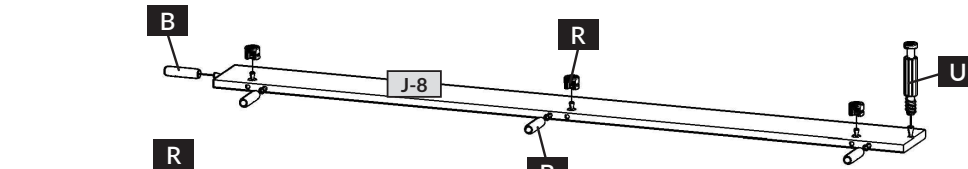
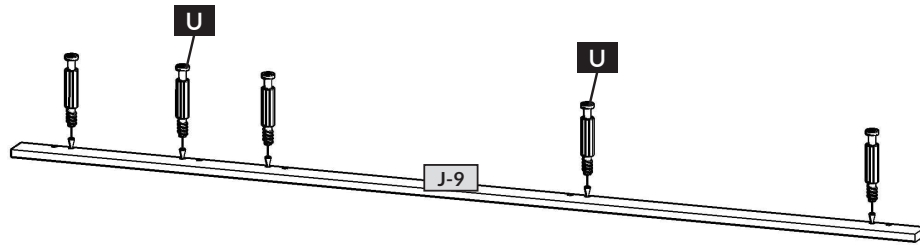
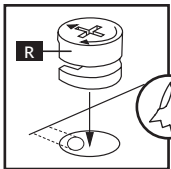
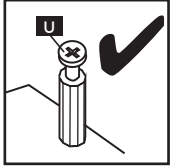

12

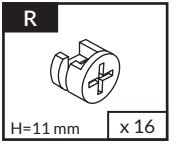
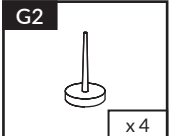
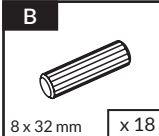
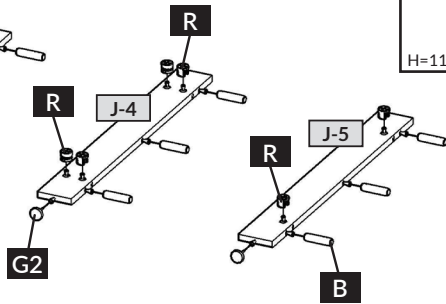
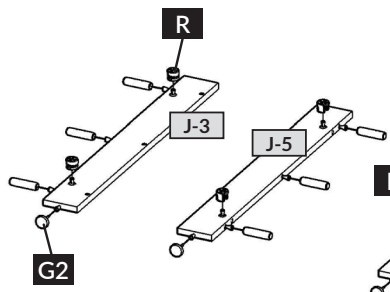
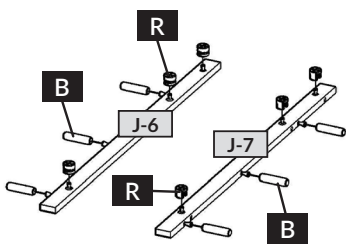
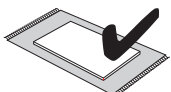
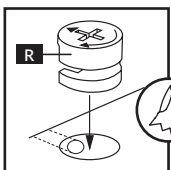

13

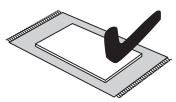
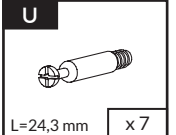
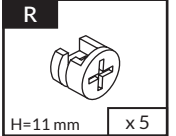
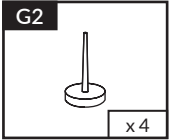
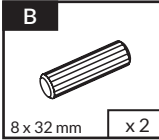
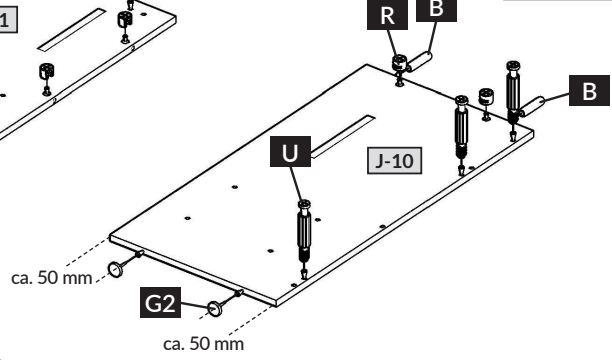
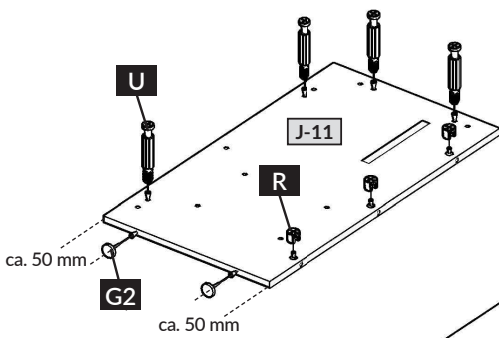
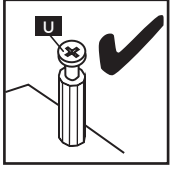
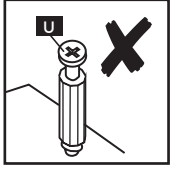
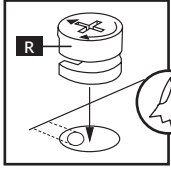

12

3D - J

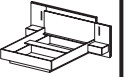

14

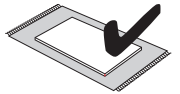
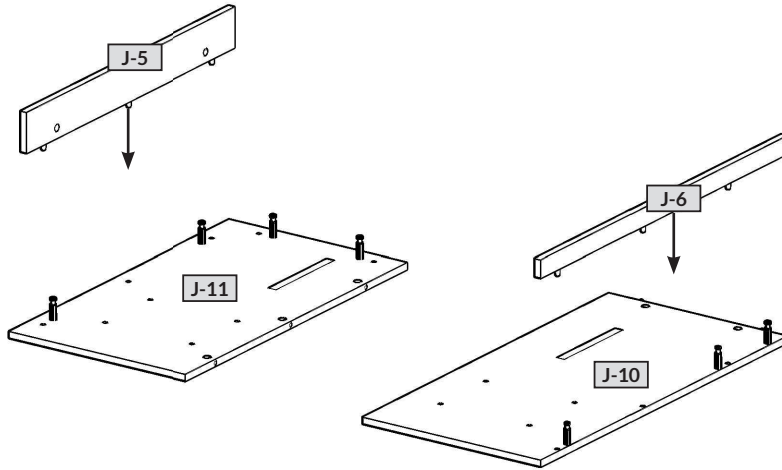

15

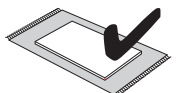
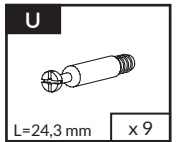
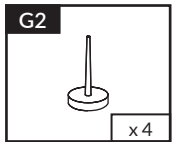
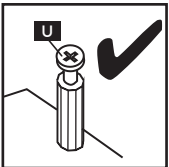
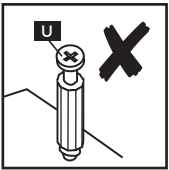
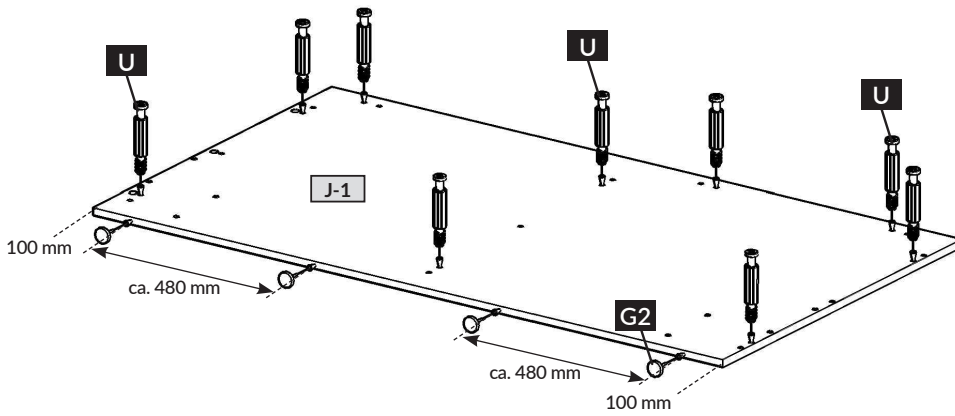

16

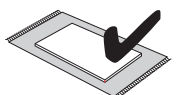
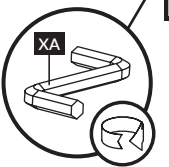
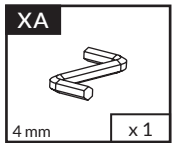
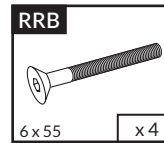
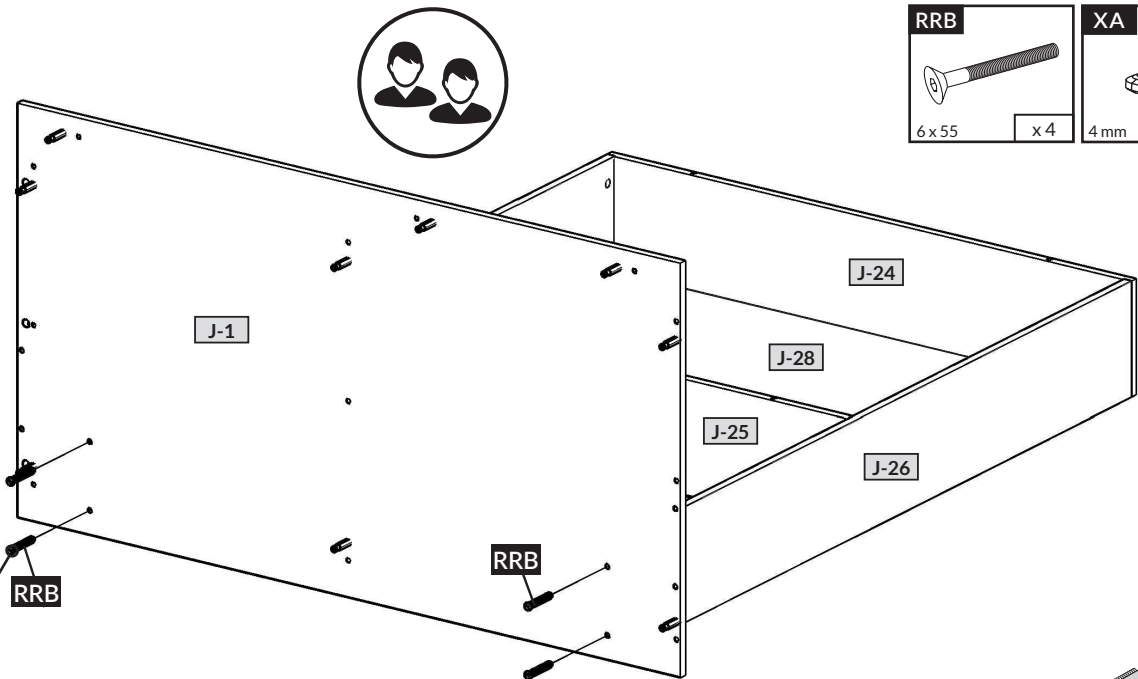

13

3D - J

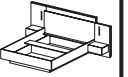

17

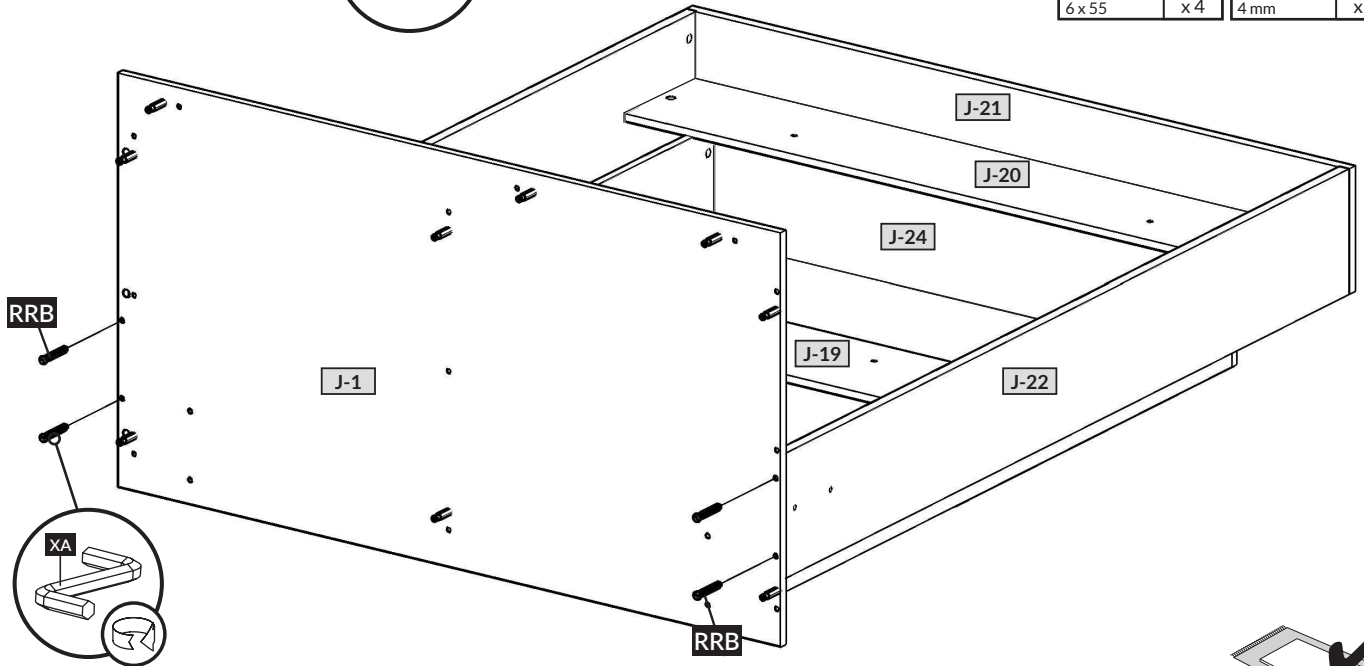
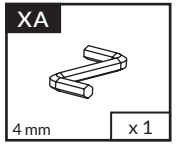
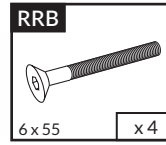

18

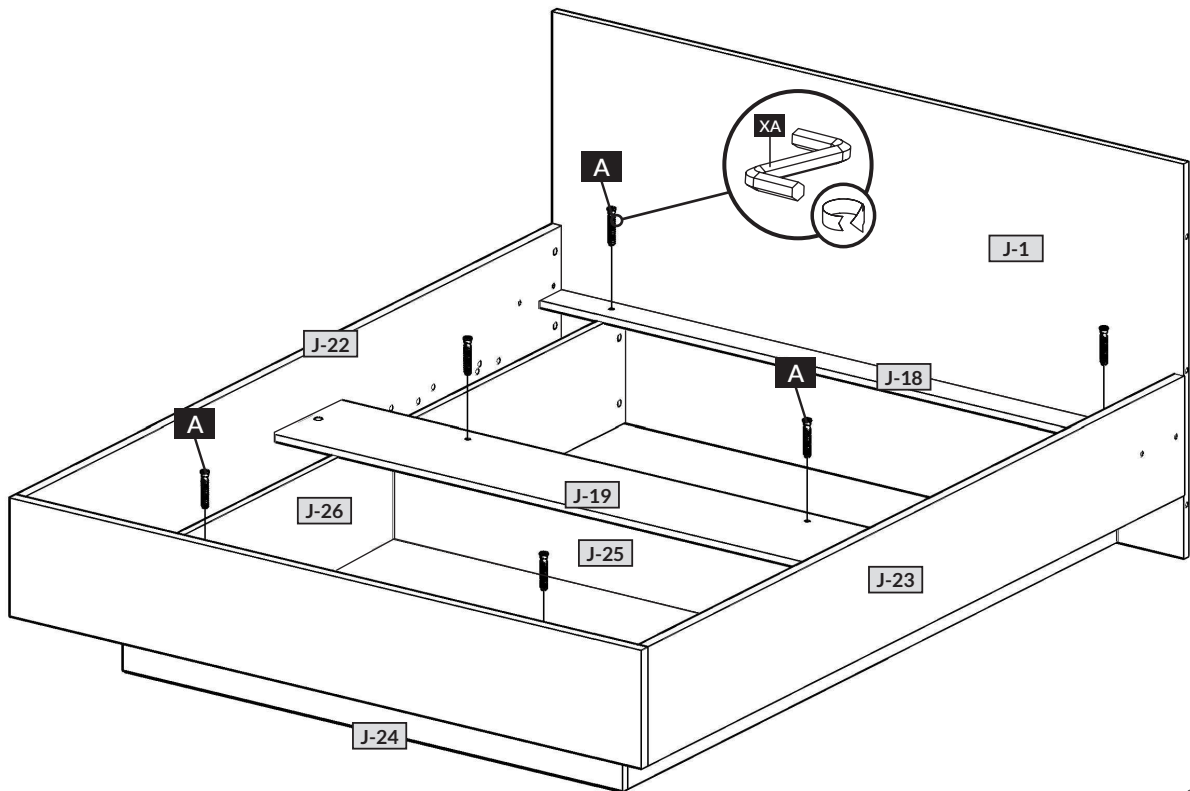
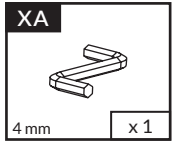
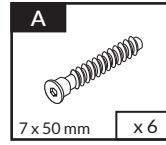

14

3D - J

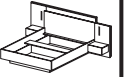

19

R



H=11 mm x 3

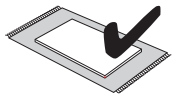
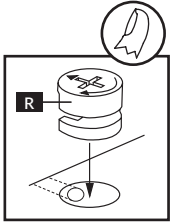
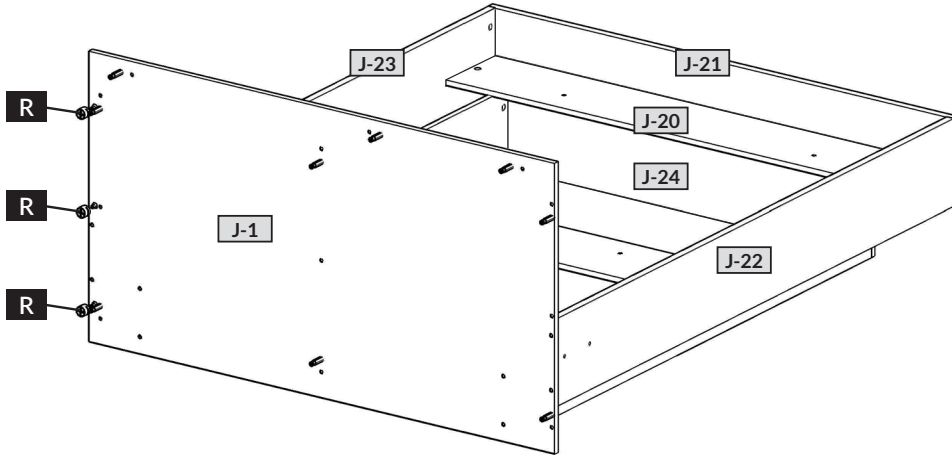

20

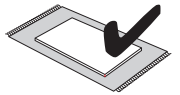
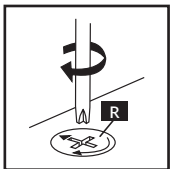
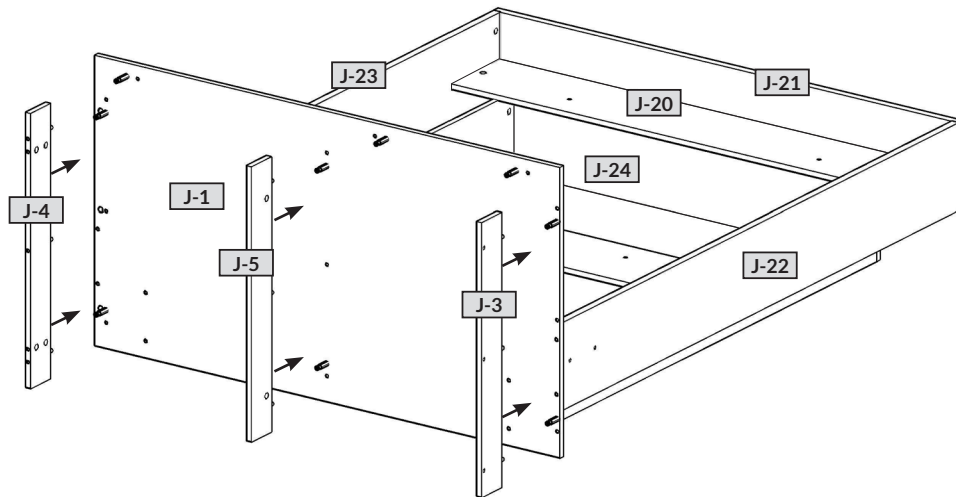

21



U6

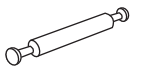

L=54 mm x 3

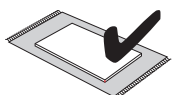
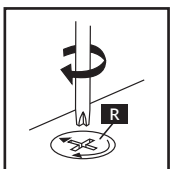
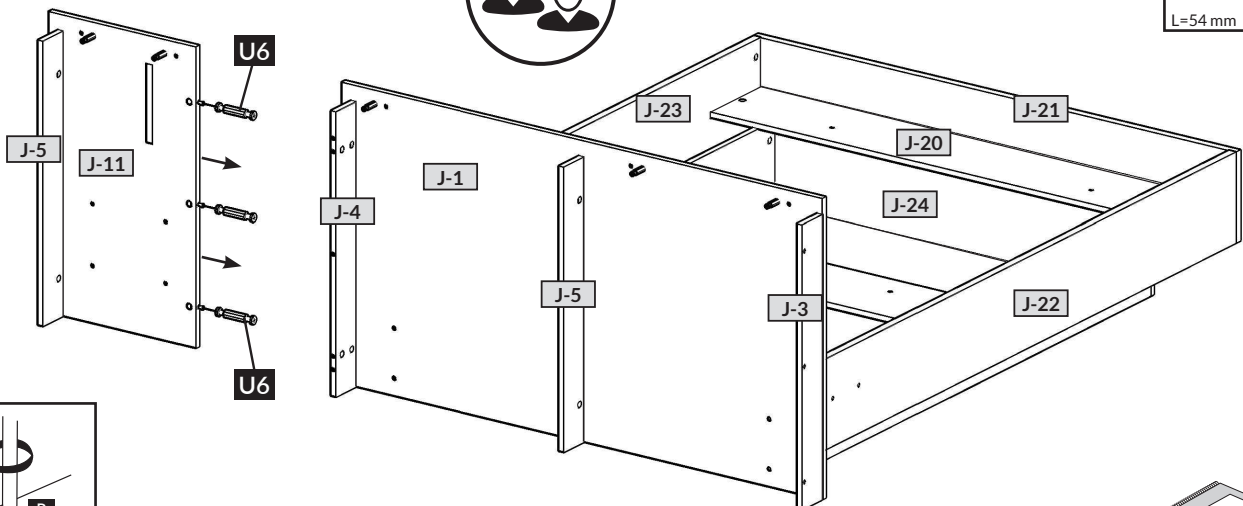

15

3D - J

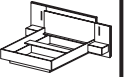

22

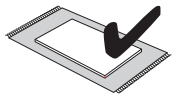
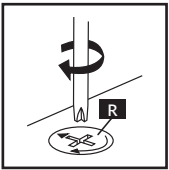
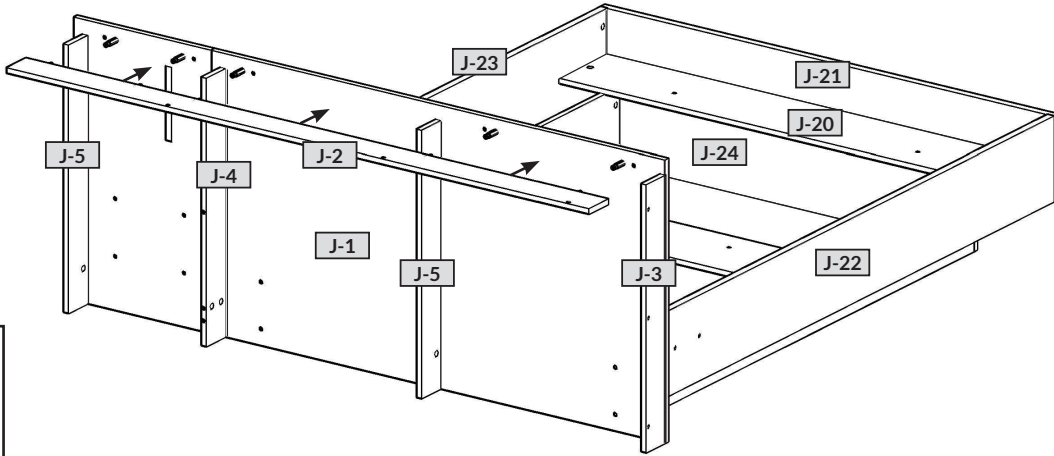

23

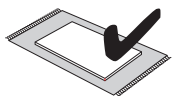
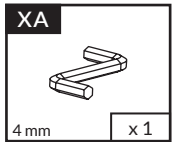
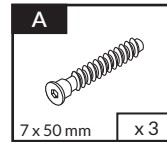
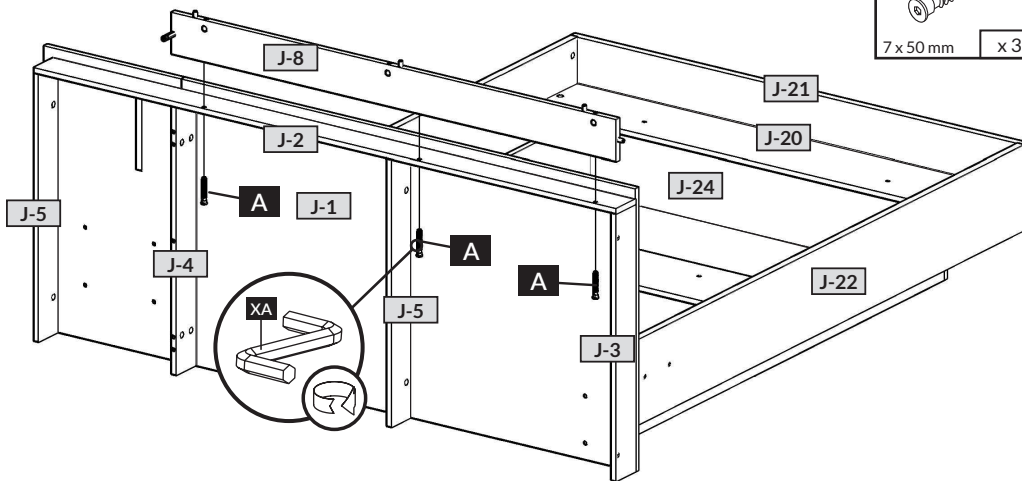

24

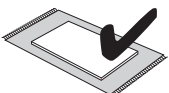
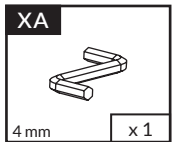
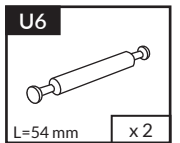
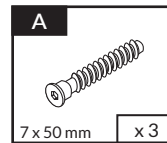
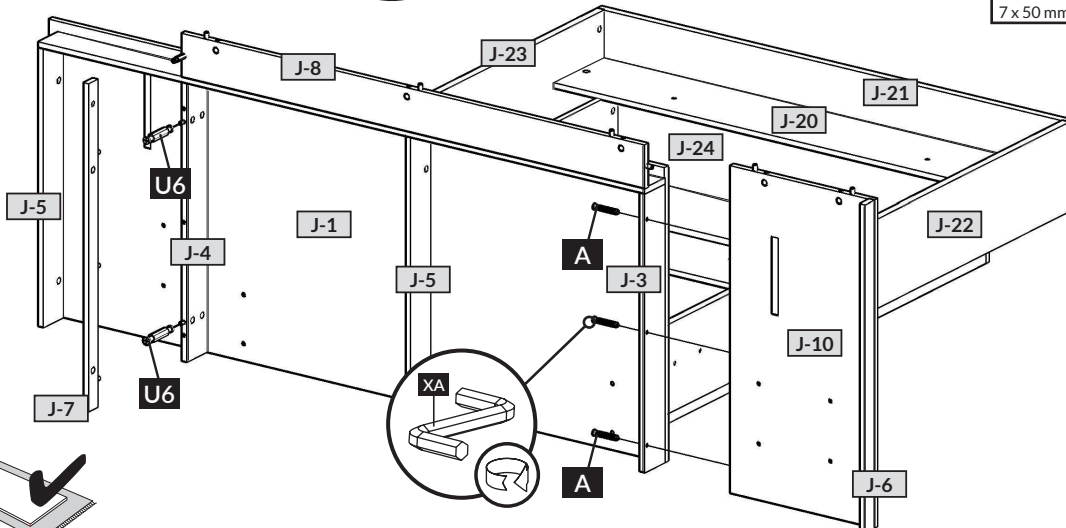

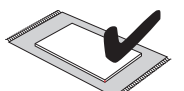
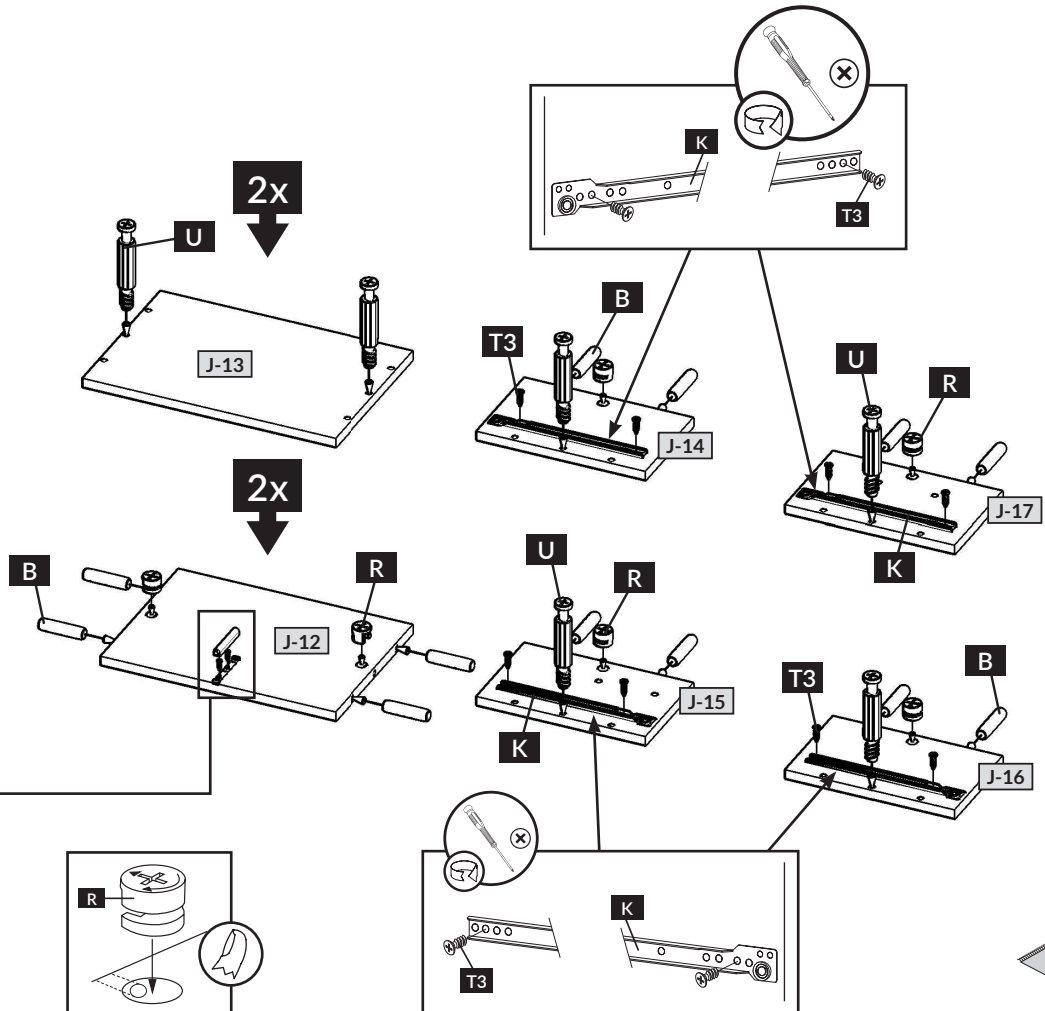
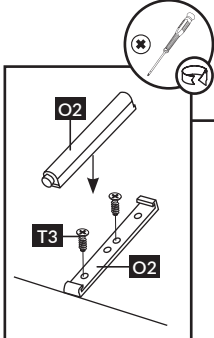
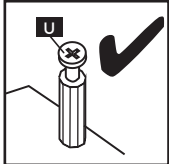
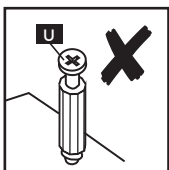
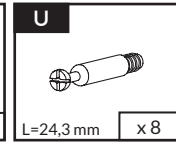
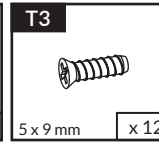
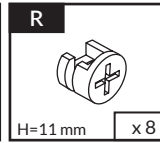
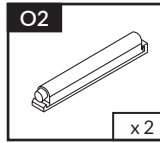
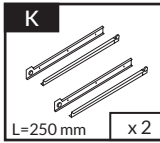
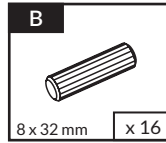
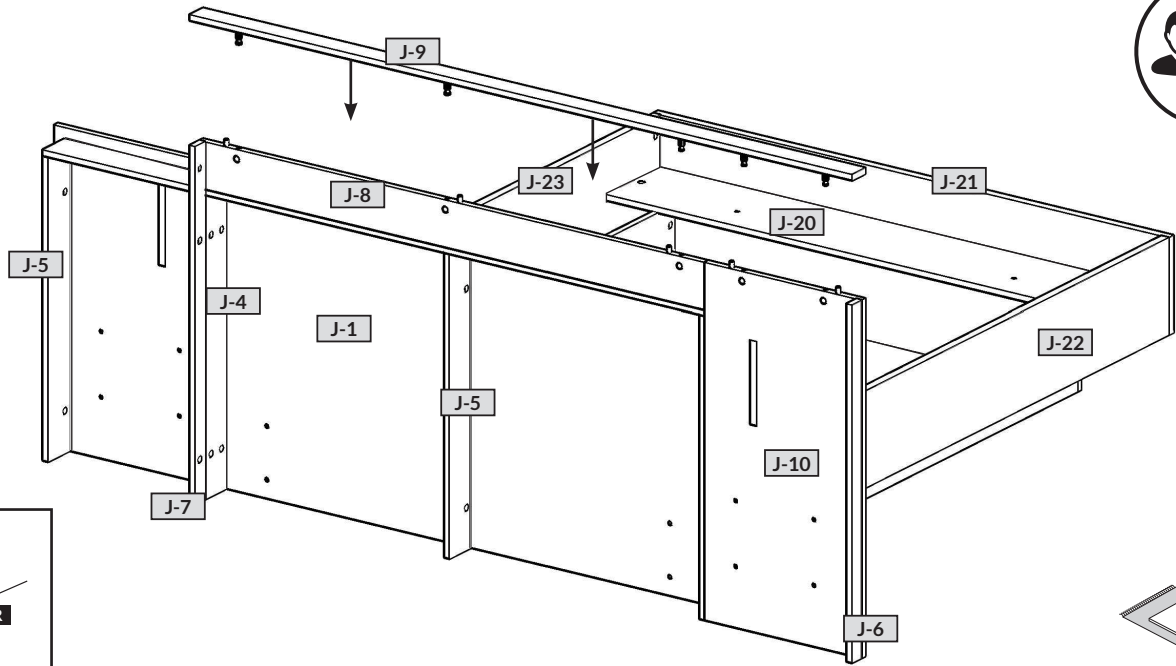
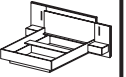

17

3D - J

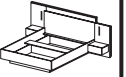

27

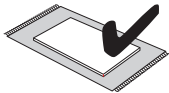
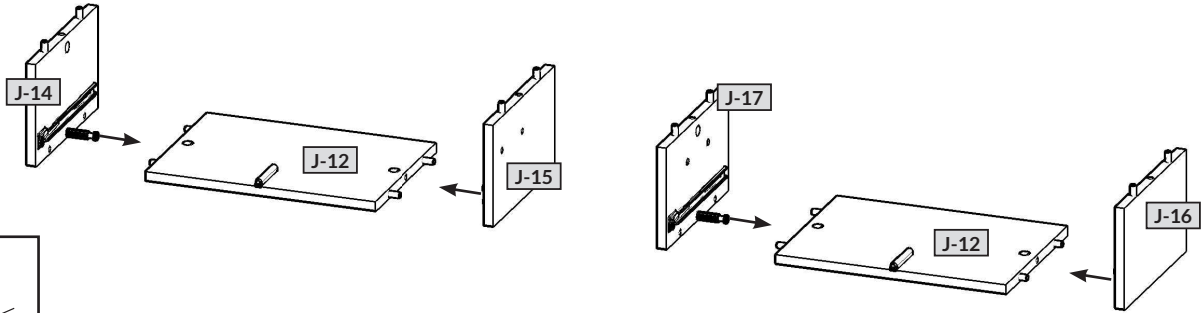

28

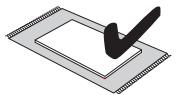
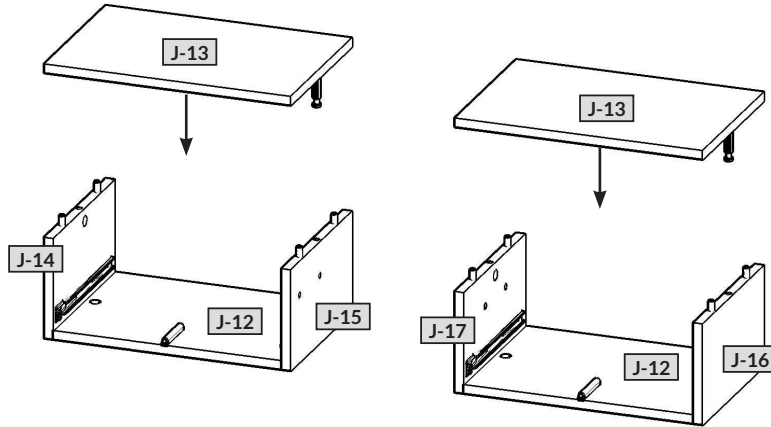

29

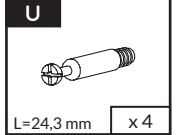
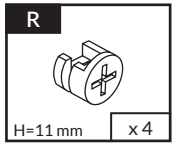
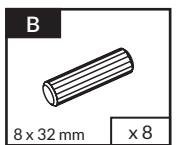
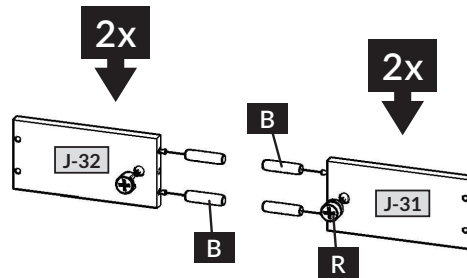
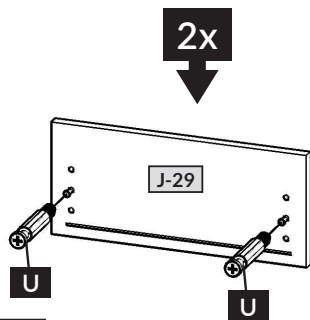
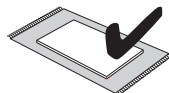
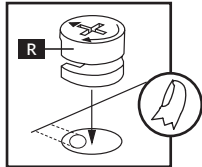
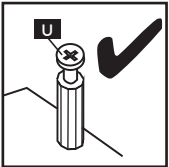
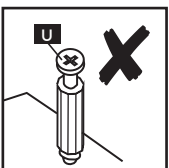

30

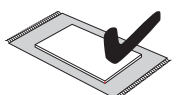
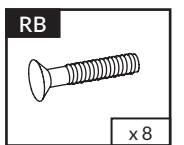
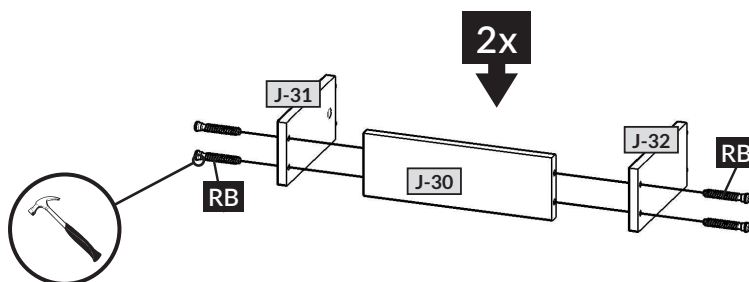

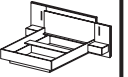

31

2x

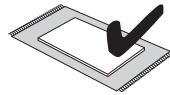
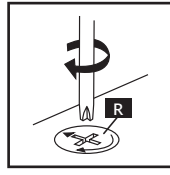
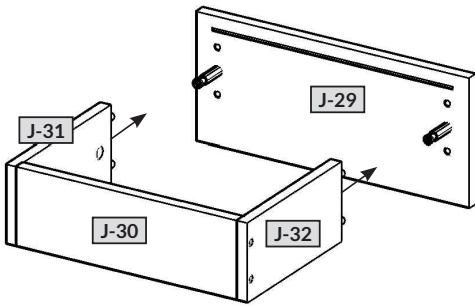

32

2x

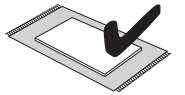
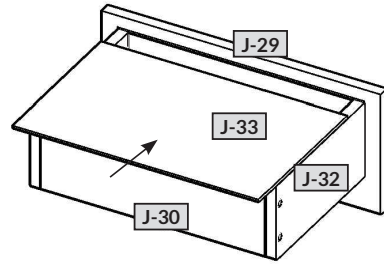

33

2x

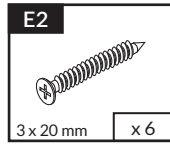
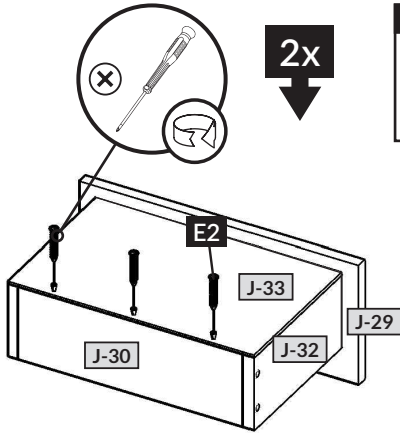

34

2x

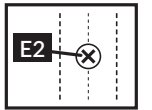
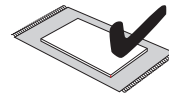
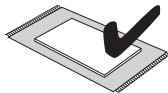
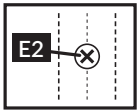
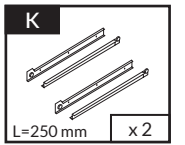
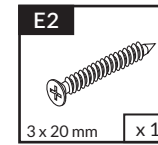
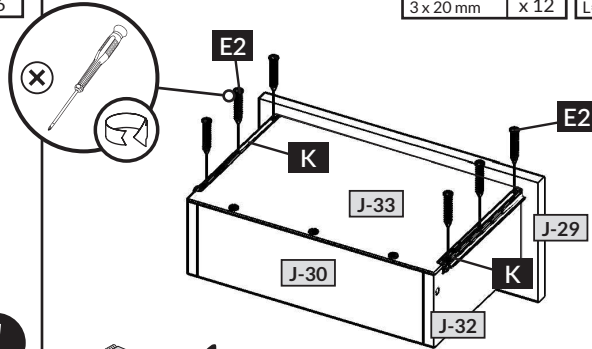

35

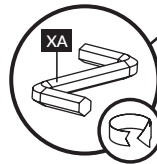
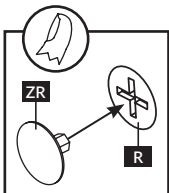
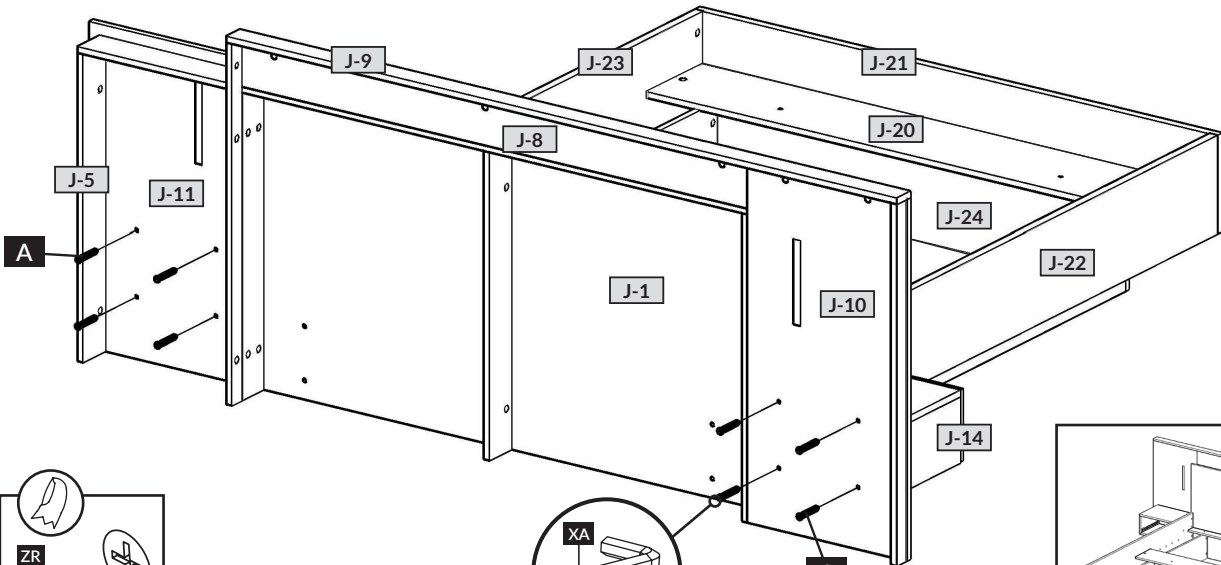
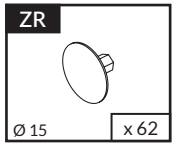
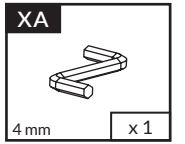
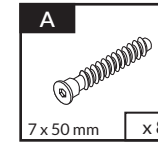

A

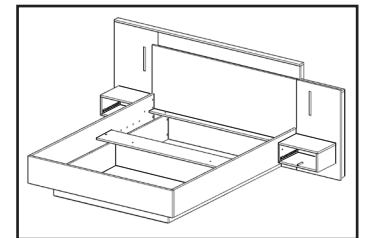

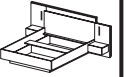

36

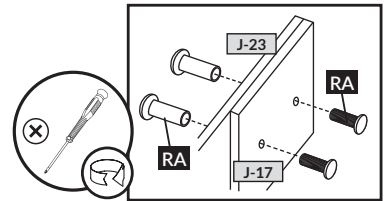
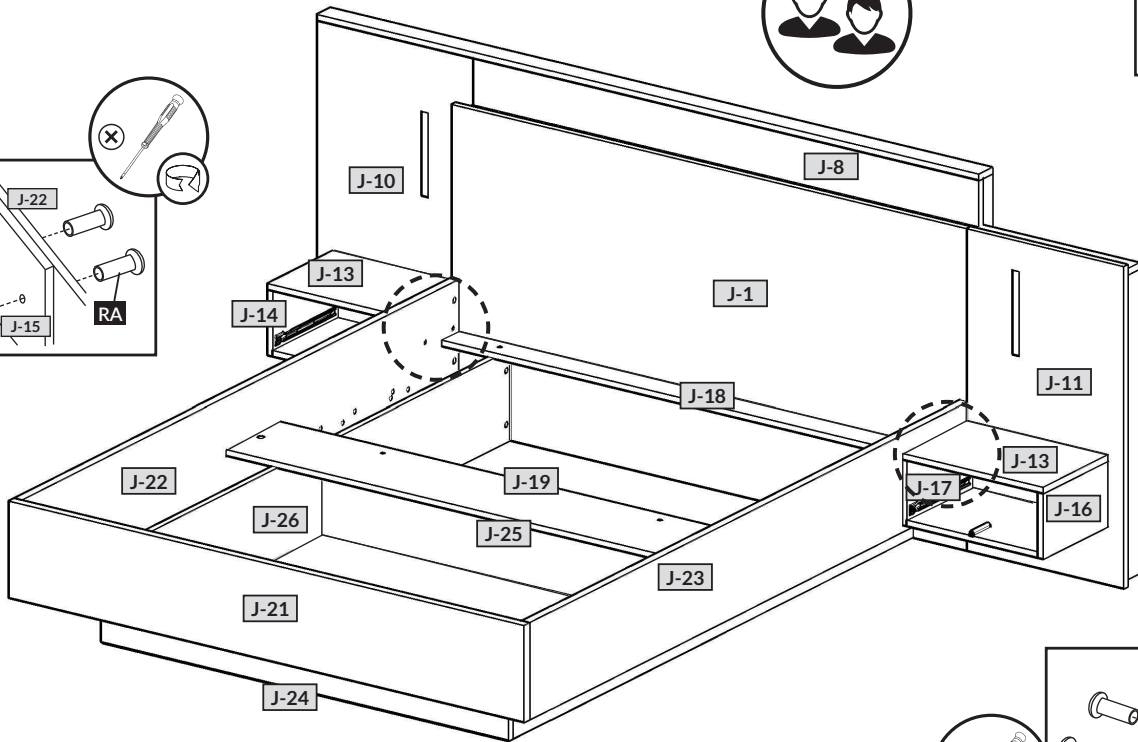
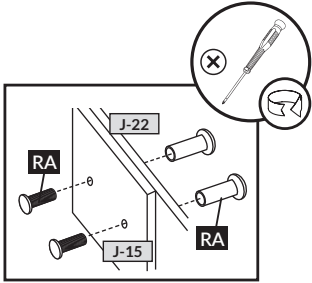
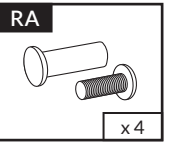

37

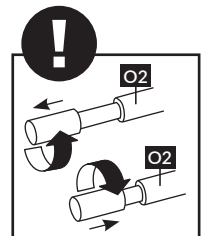
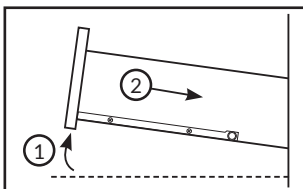
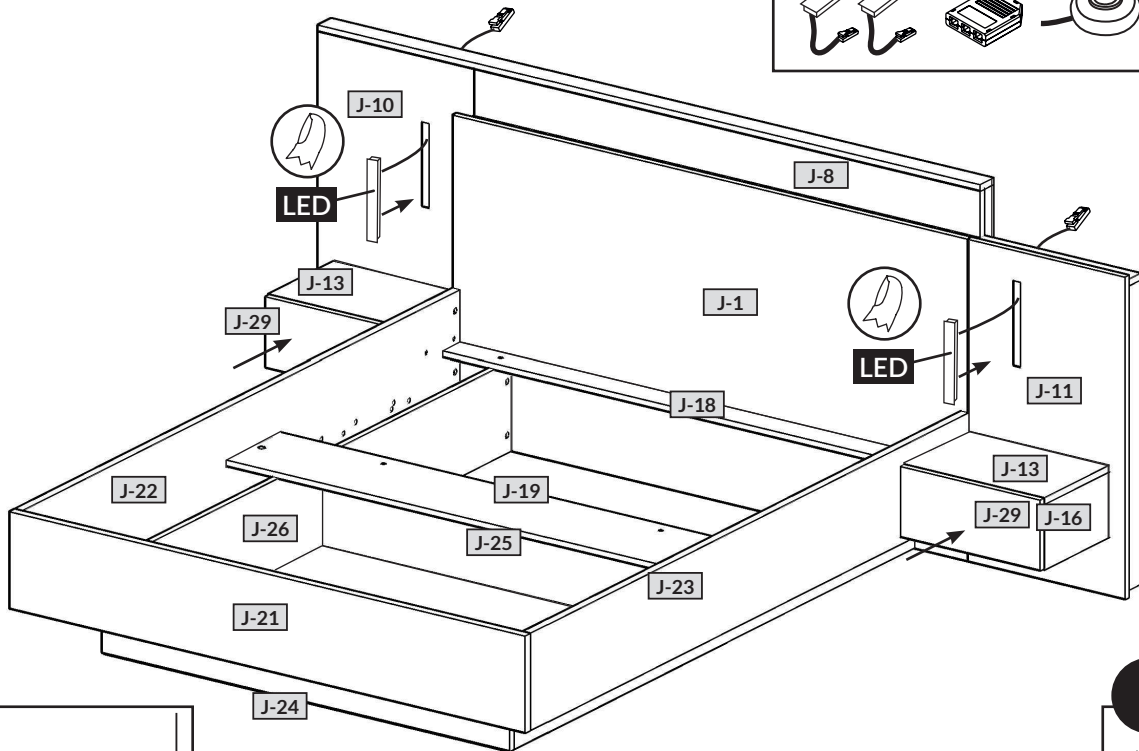
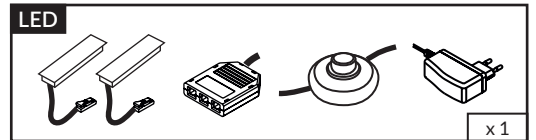



A

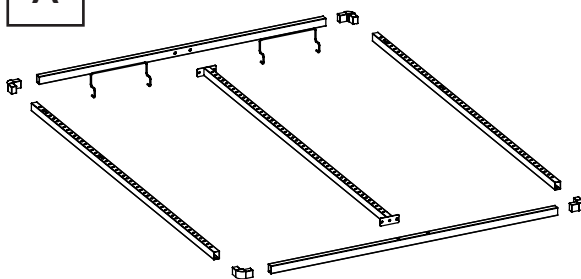

C

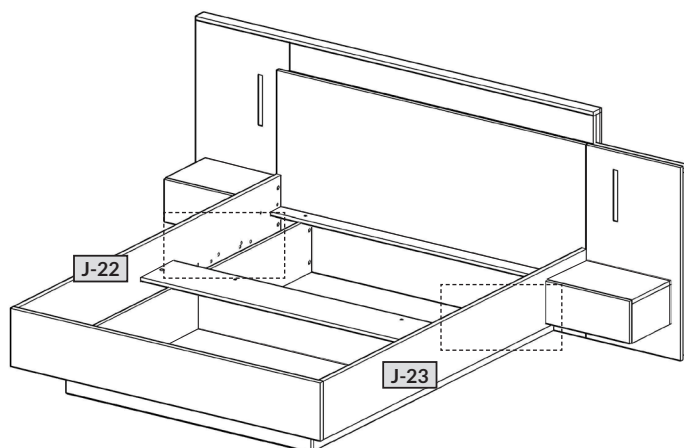
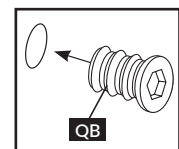
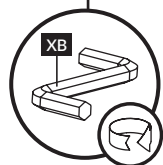
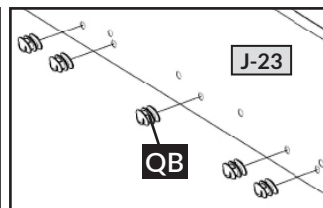
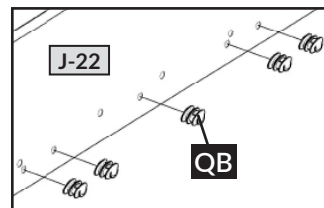
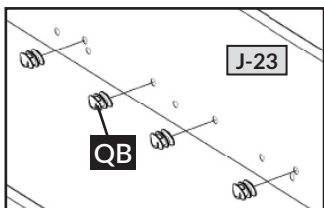
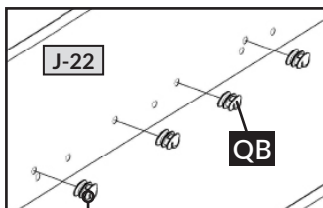
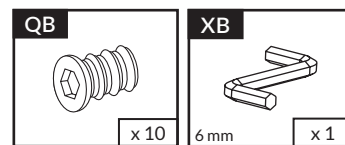
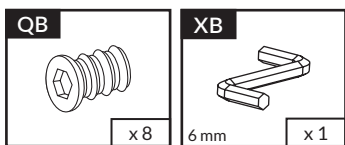
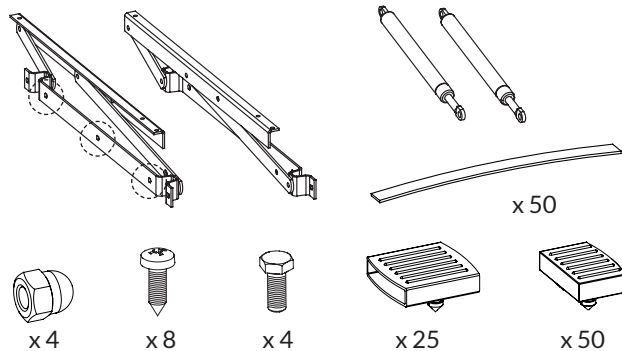
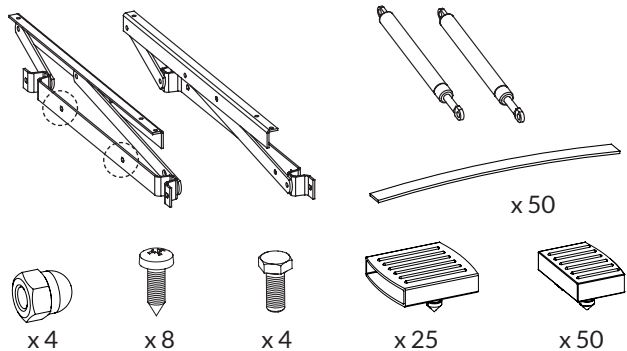
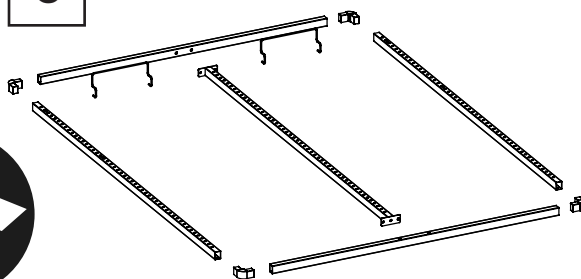



A

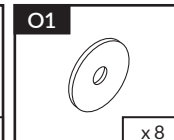
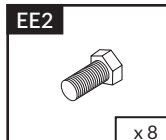
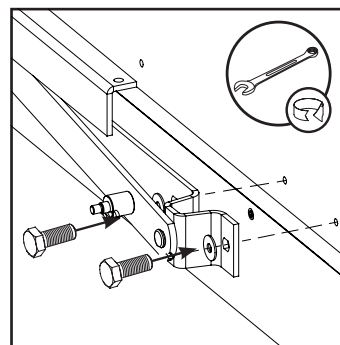
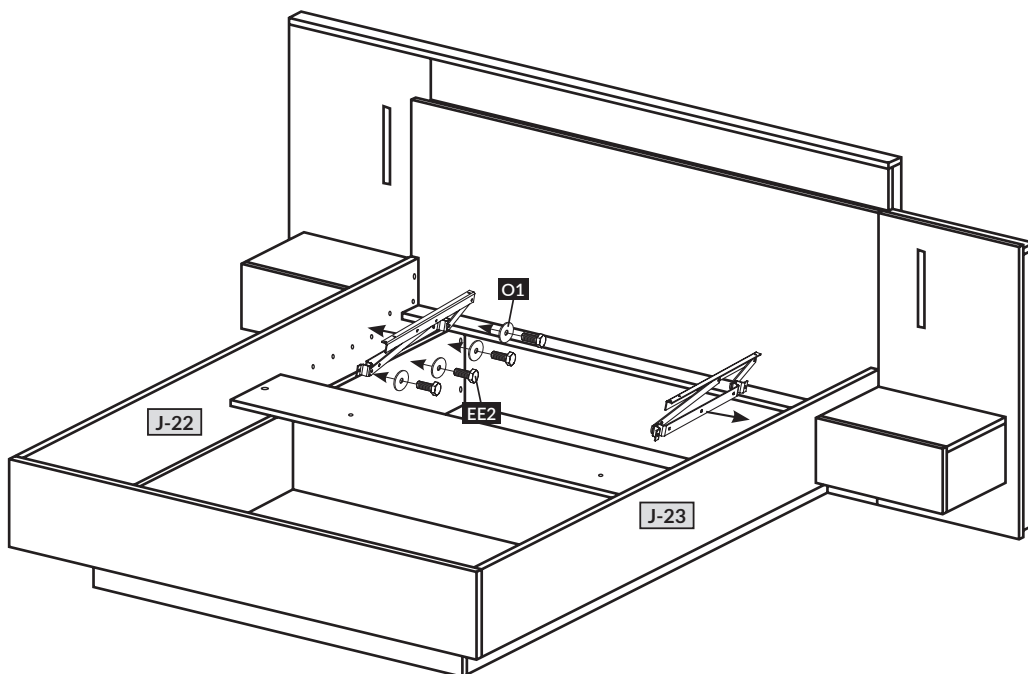

C

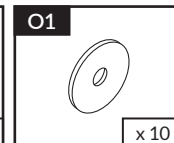
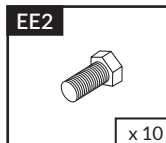
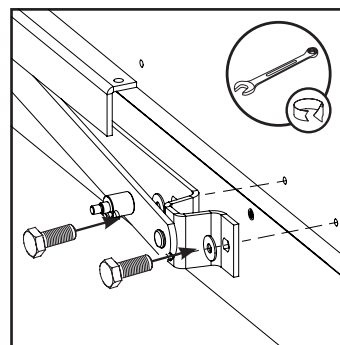
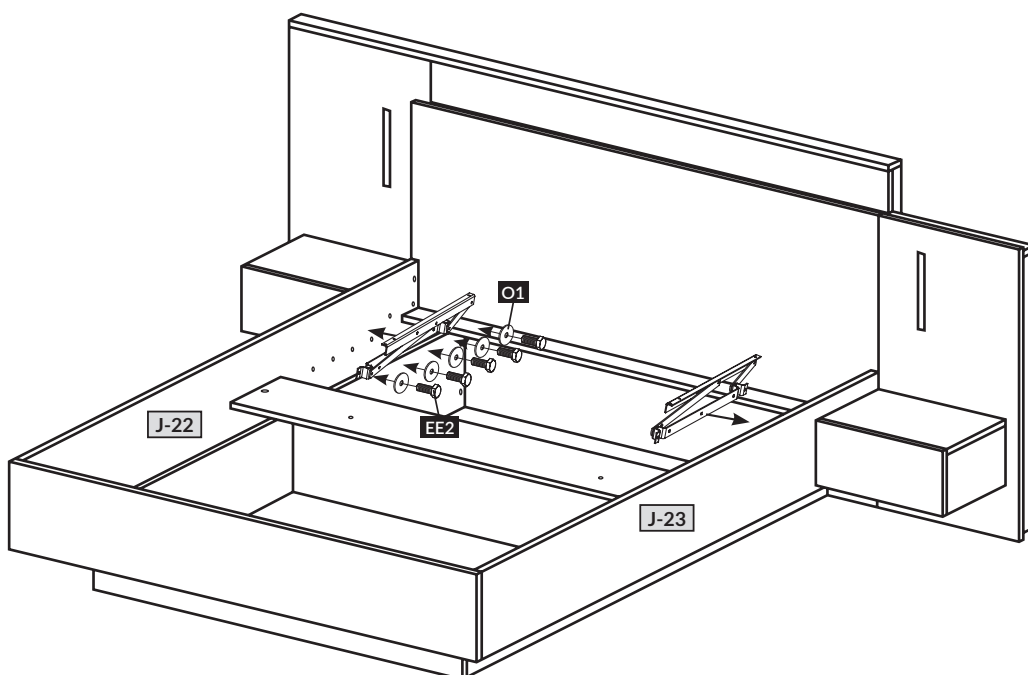

Name • Nom • Nome • Naam • Nazwa • Иméно
• Názov • Név • Denumire • Isim • Извание

Nr • No • N° • Номер • Č • Sz

Typ • Type • Tip • Típus • Tipo • Tun

3D

J

D Unser Direktservice für Beschlagteile
Sollte Ihnen ein Beschlagteil fehlen, können Sie diese Servicekarte
direct an die untenstehende Nummer senden. Wir können allerdings
nur Beschlagteile auf diesem Weg verschicken. Sollen Sie eine andere
Beanstandung an Ihrem Möbelstück haben, so wenden Sie sich bitte
direkt an Ihr Möbelhaus.

GB Our direct order service for fitting
If a fitting should be missing to you, you know this service map
directly following number faxes. We can in this way send away
however only fitting. If you should have another objection to your
piece of furniture, then they turn please to your furniture house.

CZ Naše přímé služby pro kování!
Chybí-li vám nějaký díl z kování, můžete tuto servisní kartu odfaxovat
přímo na níže uvedené číslo. Touto cestou však můžeme zposlat jen
díly kování. Pokud byste reklamovali jiný díl nábytku, obraťte se přímo
na svého prodejce nábytku.

F Bien étudier la notice de montage
Repérez les pièces constituant votre meuble. Regroupez et contrôlez la
quincaillerie. Munissez - vous de l'outillage nécessaire. Aménagez -
vous une zone de montage. Procédez au montage. Ne jamais forcer
les assemblages. Resserrez les vis après quelques temps d'usage.
Garder votre notice de montage, si une pièce venait à manquer, elle
serait le plus clair moyen de communiquer avec votre magasin.

I Il nostro servizio diretto per l'ordine della ferramenta
Nel caso vi mancassero dei pezzi, potete spedire fax questa carta di
servizi direttamente al seguente numero. Per altri reclami al vostro
mobile, potete rivolgervi al vostro mobilificio.

BG Директно обслужаване на еднкателни "Обзор"
Ако ладката част е отсъствала, директно можете да ни изпратите
картата с номер на факса - номер, до който до-ржи. До това
ни няма да се връщат други части на мебелта. Ако имате друг
въпрос относно мебелта, моля да се обърнете директно към
продавача на мебелта.

NL Onze directservice voor losse onderdelen
Wanneer er een onderdeel mist kunt u deze servicekaart direct aan
onderstaand faxnummer sturen. Wij kunnen alleen langs deze weg
onderdelen versturen. Mocht u een ander probleem aan uw meubel
hebben verzeken wij u contact op te nemen met uw meubeldealer.

PL Nasz bezpośredni serwis części montażowych
Jeżeli brakuje części koniecznych do montażu, prosimy o przesłanie
nam tej karty serwisowej na niżej podany numer faxu. Możemy w ten
sposób przysłać państwu tylko brakujące części. W przypadku innych
objawów dotyczących mebla, prosimy o zgłoszenie ich do salonu
meblowego w którym został dokonany zakup.

HR Servis za okove
U slučaju da nedostaje neki od dijelova molimo vas da na dolje
navedeni broj posaljete ovaj servisni obrazac. Na ovaj način mogu
se dostaviti samo okovi. U slučaju da imate dodatne prigovore vezane
uz komad namještaja molimo vas da se obratite izravno trgovini
namještaja gdje je isti kupljen.

HU Direktszolgálatunk vasalatok esetén
Ha hiányzik egy vasalat, ezt a kártyát közvetlenül elfaxolhatja az alább
található faxszámra. Azonban csak vasalatoikat tudunk így küldeni.
Amennyiben másféle reklamációt áll fenn bútordarabjait illetően,
forduljon közvetlenül a bútornáhhoz.

SK Naše priamy servis pre časťi kovania
Ak by Vám chýbala nejaká časť kovania, môžete poslať túto servisnú
kartu poslať faxom priamo na nižšie uvedené číslo. Díly
kovania vieme poslať iba týmto spôsobom. Ak by ste mali inú
reklamáciu ohľadom Vášho nábytku, obraťte sa priamo na Vašu
predajnú nábytku.

SLO Naše direktno služne storitve za okovje
Ce vam manjka kakšno okovje, lahko to servisno kartico pošljete po
faksu direktno na spodnjo številko. Po tej poti vam lahko pošljemo
samo okovje. Če želite reklamirati kakšen drug del pohištva, se obrnite
neposredno na vašo trgovino pohištva.

RO Service-ul nostru direct pentru feronerie
In cazul in care va lipsesc o piesa de feronerie puteti sa trimitezi
direct acest card de service pe fax la numarul de mai jos. Noi nu
putem expedia piese de feronerie decat pe acest fel de cale. Dacă aveți o
altă reclamație referitoare la piesa de mobilier, atunci vă rugăm să vă
adresati direct la magazinul dvs. de mobilă.

RUS Наш прямой сервис для поставок фурнитуры
Если окажется, что Вам не хватает того или иного элемента
фурнитуры, Вы можете отправить сервисную карту по Факсу
непосредственно на нижеприведенный номер. Однако, таким
образом мы можем пересылать лишь фурнитуру. Если же у Вас
возникнут иные претензии относительно приобретенной мебели,
пожалуйста, обращайтесь непосредственно в организацию,
осуществившую продажу.

S Vår direktservice för beslagdelar
Om du saknar en beslagdel kan du faxa detta servicekort direkt till
numret som anges ned. Tänk på att detta är den enda möjligheten att
skicka beslagdelar till dig. Om du vill reklamera din möbel av en
annan anledning måste du kontakta ditt möbelhus direkt.

ES Nuestro servicio directo para accesorios
Si le falta algún accesorio, puede enviar esta tarjeta de servicio
directamente a la siguiente dirección. No obstante, por este método
solo podemos enviar accesorios. Si tiene alguna otra objeción sobre su
mueble, consulte directamente con su mueblería.

TR Donatılar için doğrudan servisliz
Bir donatınız eksikse bu servis kartını doğrudan aşağıda bulunan
adrese doğrudan mail yazabilirsiniz. Sadece bu yolla donatıları
gönderebiliriz. Mobilyanızda başka şikayetleriniz varsa lütfen doğrudan
mobilya satıcınıza danışın.

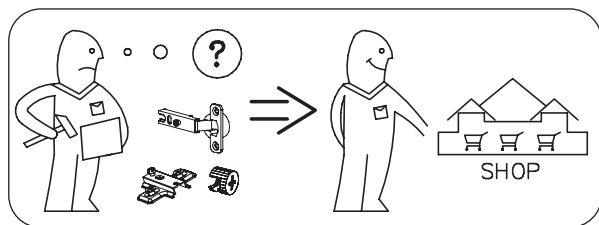
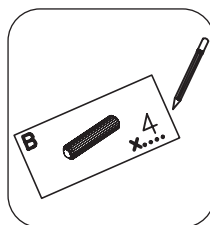
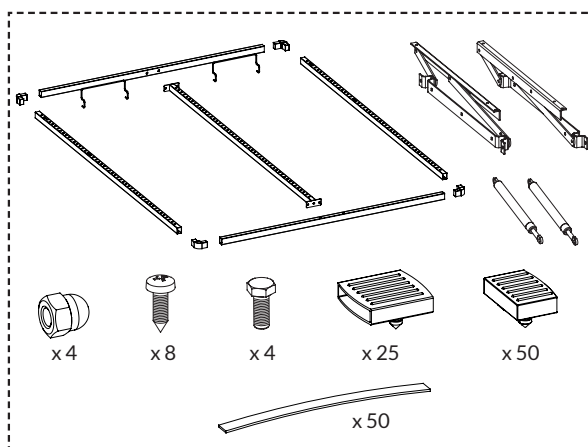
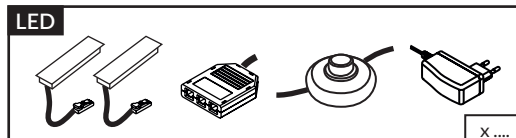
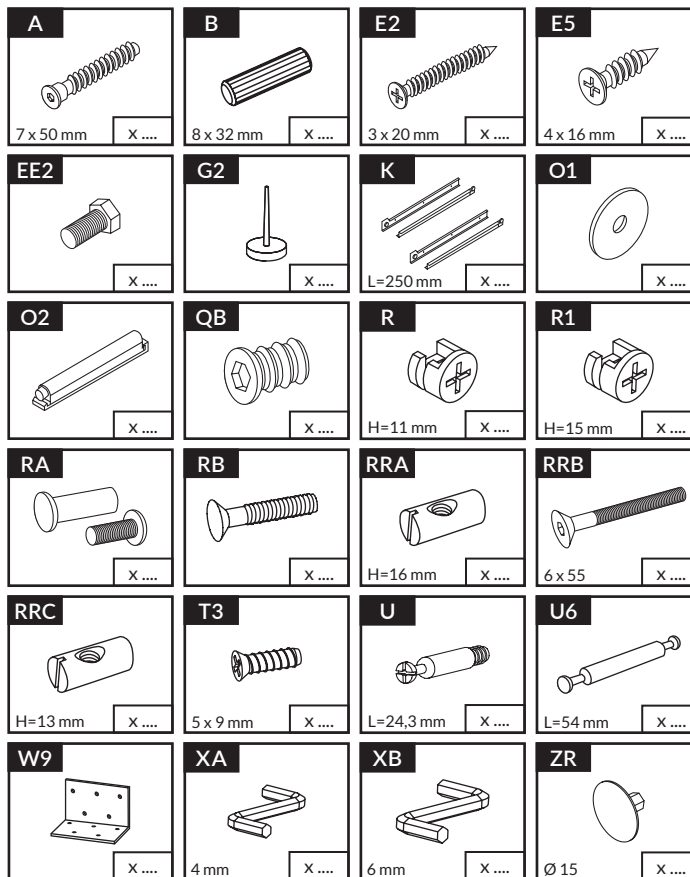

23

Service • Assistenza • Dienstverlening • Serwis • Servis • Szerviz • Сервисная служба

Name • Nom • Nome • Naam • Nazwa • Иméно
• Názov • Néв • Denumire • Isim • Извание

Nr • No • N° • Номер • Č • Sz

Typ • Type • Tip • Típus • Тipo • Tun

3D

--

J

D

Unser Direktservice für Beschlagteile
Sollte Ihnen ein Beschlagteil fehlen, können Sie diese Servicekarte
direct an die untenstehende Nummer senden. Wir können allerdings
nur Beschlagteile auf diesem Weg verschicken. Sollen Sie eine andere
Beanstandung an Ihrem Möbelstück haben, so wenden Sie sich bitte
direkt an Ihr Möbelhaus.

GB

Our direct order service for fitting
If a fitting should be missing to you, you know this service map
directly following number fixes. We can in this way send away
however only fitting. If you should have another objection to your
piece of furniture, then they turn please to your furniture house.

CZ

Naše přímé služby pro kování
Chybí-li vám nějaký díl z kování, můžete tuto servisní kartu odfaxovat
přímo na níže uvedené číslo. Touto cestou však můžeme zoslat jen
díly kování. Pokud byste reklamovali jiný díl nábytku, obraťte se přímo
na svého prodejce nábytku.

F

Bien étudier la notice de montage
Resserrez les pièces consultant votre meuble. Regroupez et contrôlez la
quincaillerie. Munissez - vous de l'outillage nécessaire. Aménagez -
vous une zone de montage. Procédez au montage. Ne jamais forcer
les assemblages. Resserrez les vis après quelques temps d'usage.
Gardez votre notice de montage, si une pièce venait à manquer, elle
serait le plus clair moyen de communiquer avec votre magasin.

I

Il nostro servizio diretto per l'ordine della ferramenta
Nel caso vi mancassero dei pezzi, potete spedire fax questa carta di
servizi direttamente al seguente numero. Per altri reclami al vostro
mobile, potete rivolgervi al vostro mobilificio.

BG

Директно обслужаване на едници от тип "Обзор"
Ако ви липнева някаква част/кованка, можете да изпратите тази сервисна
карта по факс на адреса, даден по-долу. По този начин можем да ви
послат само частите/кованките. Ако имате друга претензия относно
вашето обзаведено място, моля да се обърнете директно към вашия
продавач на мебели.

NL

Onze directservice voor losse onderdelen
Wanneer er een onderdeel mist kunt u deze servicekaart direct aan
onderstaand faxnummer sturen. Wij kunnen alleen langs deze weg
onderdelen versturen. Mocht u een ander probleem aan uw meubel
hebben verzoeken wij u contact op te nemen met uw meubeldealer.

PL

Nasz bezpośredni serwis części montażowych
Jeżeli brakuje części koniecznych do montażu, prosimy o przesłanie
nam tej karty serwisowej na niżej podany numer faxu. Możemy w ten
sposób przysłać państwu tylko brakujące części. W przypadku innych
objawów dotyczących mebla, prosimy o zgłoszenie ich do salonu
meblowego w którym został dokonany zakup.

HR

Servis za okove
U slučaju da nedostaje neki od dijelova molimo vas da na dolje
navedeni Fax broj posaljete ovaj servisni obrazac. Na ovaj način mogu
se dostaviti samo okovi. U slučaju da imate dodatne prigovore vezane
uz komad namještaja molimo vas da se obratite izravno trgovini
namještaja gdje je isti kupljen.

HU

Direktszoállításunk vasalatók esetén
Ha hiányzik egy vasalató, ezt a kártyát közvetlenül elfaxolhatja az alább
található faxszáma. Azonban csak a vasalatókat tudunk így küldeni.
Amennyiben másféle reklamációt áll fenn bútorárbaját illetően,
forduljon közvetlenül a bútorházzal.

SK

Naše priamy servis pre časť kovania
Ak by Vám chýbala nejaká časť kovania, môžete poslať túto servisnú
kartu poslať faxom priamo na nižšie uvedené faxové c číslo. Díly
kovania vieme poslať iba týmto spôsobom. Ak by ste mali inú
reklamáciu ohľadom Vášho nábytku, obraťte sa priamo na Vašu
predajnú nábytku.

SLO

Naše direktno služne storitve za okovje
Ce vam manjka kakšno okovje, lahko to servisno kartico pošljete po
faksu direktno na spodnjo številko. Po tej poti vam lahko pošljemo
samo okovje. Če želite reklamirati kakšen drug del pohištva, se obrnite
neposredno na vašo trgovino pohištva.

RO

Service-ul nostru direct pentru feronerie
In cazul in care va lipsesc o piesa de feronerie puteti sa trimitezi
direct acest card de service pe fax la numarul de mai jos. Noi nu
putem expedia piese de feronerie decat pe acest fel de cale. Decat aveți o
altă reclamație referitoare la piese de mobilier, atunci vă rugăm să vă
adresati direct la magazinul dvs. de mobilă.

RUS

Наш прямой сервис для поставок фурнитуры
Если окажется, что Вам не хватает того или иного элемента
фурнитуры, Вы можете отправить сервисную карту по Факсу
непосредственно на нижеприведенный номер. Однако, таким
образом мы можем пересылать лишь фурнитуру. Если же у Вас
возникнут иные претензии относительно приобретенной мебели,
пожалуйста, обращайтесь непосредственно в организацию,
осуществляющую продажу.

S

Vår direktservice för beslagdelar
Om du saknar en beslagdel kan du faxa detta servicekort direkt till
numret som anges ned. Tänk på att detta är den enda möjligheten att
skicka beslagdelar till dig. Om du vill reklamera din möbel av en
annan anledning måste du kontakta ditt möbelfhus direkt.

ES

Nuestro servicio directo para accesorios
Si le falta algún accesorio, puede enviar esta tarjeta de servicio
directamente a la siguiente dirección. No obstante, por este método
solo podemos enviar accesorios. Si tiene alguna otra objeción sobre su
mueble, consulte directamente con su mueblería.

TR

Donatılar için doğrudan servisimiz
Bir donatınız eksikse bu servis kartını doğrudan aşağıda bulunan
adrese doğrudan mail yazabilirsiniz. Sadece bu yolla donatılar
gönderiliriz. Mobilyanızda başka şikayetleriniz varsa lütfen doğrudan
mobilya satıcınıza danışın.

nr	↔ [mm]	↓ [mm]	↗ [mm]	Menge	Colli
J-1	900	1444	16	x 1	1/2
J-2	1912	100	16	x 1	2/2
J-3	852	100	16	x 1	1/2
J-4	852	100	16	x 1	2/2
J-5	852	100	16	x 2	1/2
J-6	1000	44	16	x 1	2/2
J-7	1000	44	16	x 1	2/2
J-8	132	1412	16	x 1	2/2
J-9	1912	60	16	x 1	2/2
J-10	1000	500	16	x 1	1/2
J-11	900	500	16	x 1	1/2
J-12	418	300	16	x 1	1/2
J-13	450	300	16	x 2	2/2
J-14	184	300	16	x 1	2/2
J-15	184	300	16	x 1	2/2
J-16	184	300	16	x 1	2/2
J-17	184	300	16	x 1	2/2

nr	↔ [mm]	↓ [mm]	↗ [mm]	Menge	Colli
J-18	1400	80	16	x 1	1/2
J-19	1400	250	16	x 1	1/2
J-20	1400	250	16	x 1	1/2
J-21	1445	272	22	x 1	2/2
J-22	1922	270	22	x 1	2/2
J-23	1922	270	22	x 1	2/2
J-24	1101	250	16	x 1	1/2
J-25	1068	250	16	x 1	1/2
J-26	1750	250	16	x 1	2/2
J-27	1750	250	16	x 1	2/2
J-28	1096	902	3	x 1	1/2
J-29	446	196	16	x 2	1/2
J-30	361	120	16	x 2	2/2
J-31	250	120	16	x 2	2/2
J-32	250	120	16	x 2	2/2
J-33	392	256	3	x 2	1/2

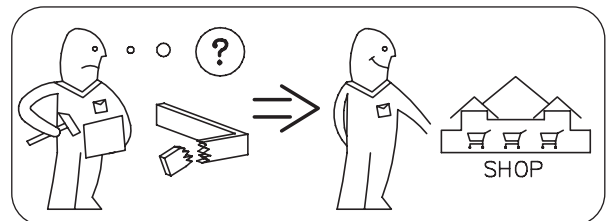
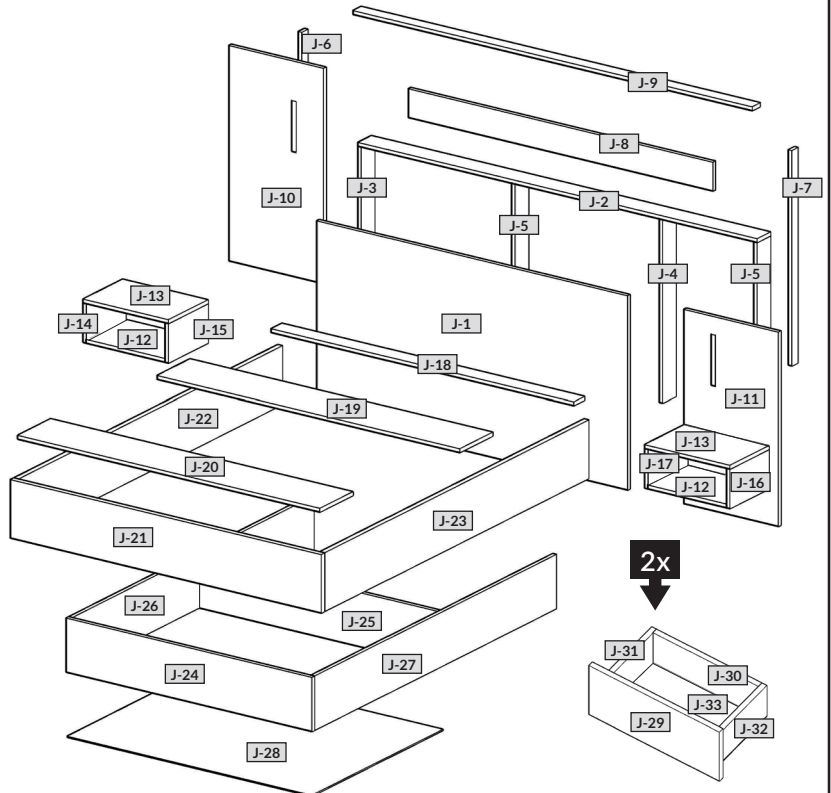



Uwaga - Upozornění - Achtung - Attention - Caution - Figyelem
 Attenzione - Opgelet - Atenție - Upozornenie - Dikkat

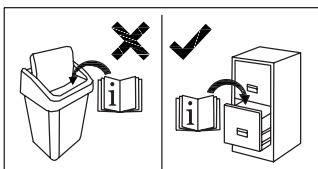
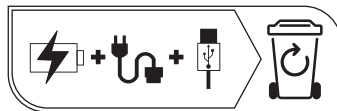
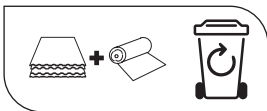
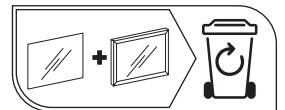
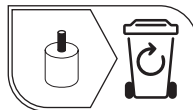
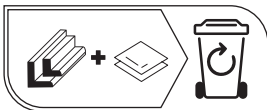
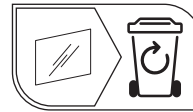
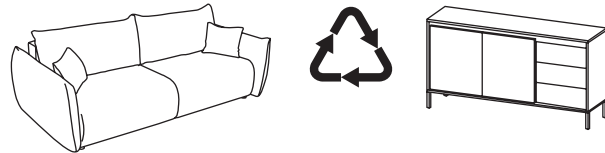
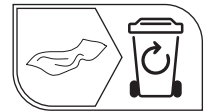
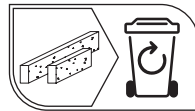
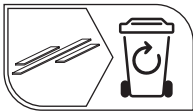
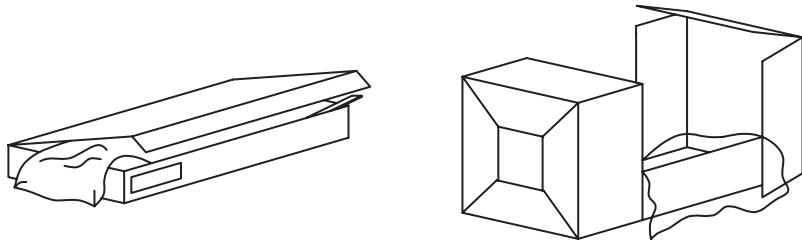



Uwaga - Upozornění - Achtung - Attention - Caution - Figyelem
 Attenzione - Opgelet - Atenție - Upozornenie - Dikkat

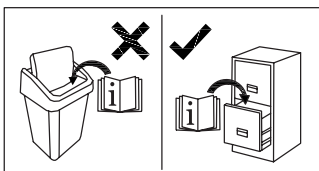
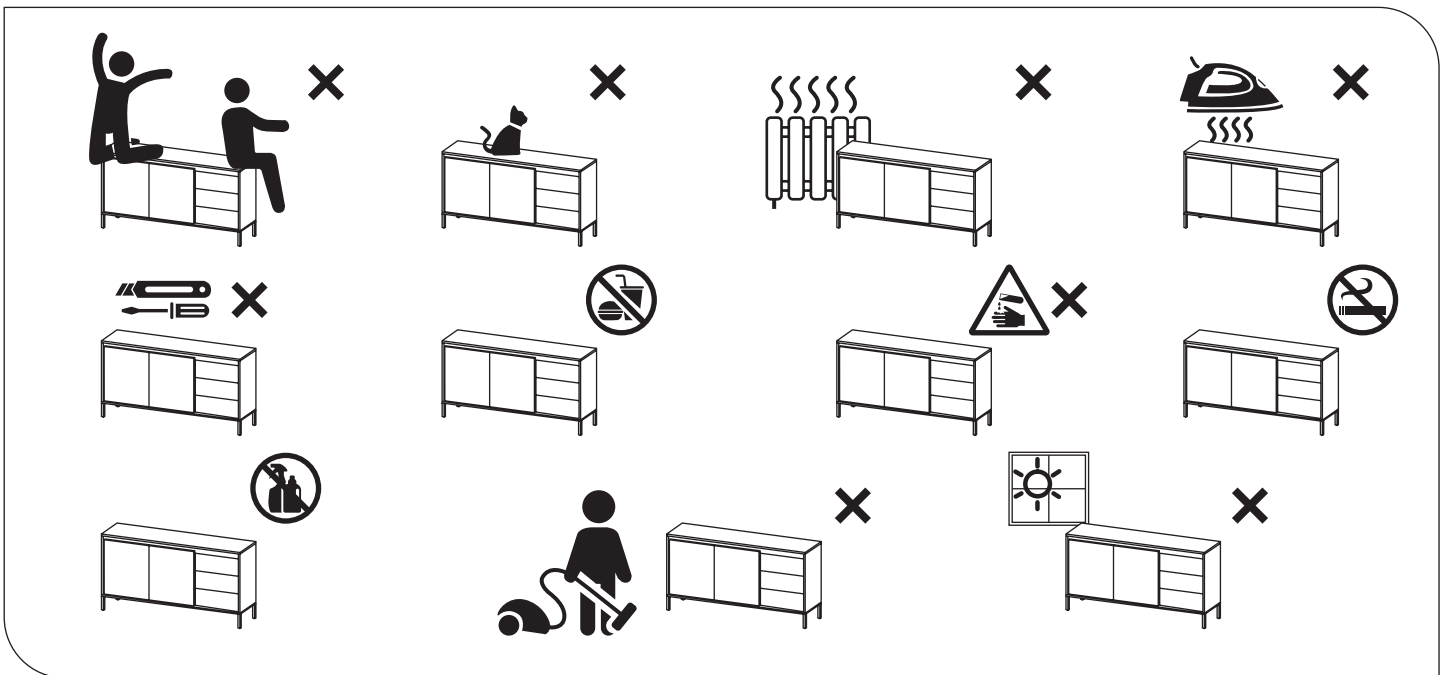
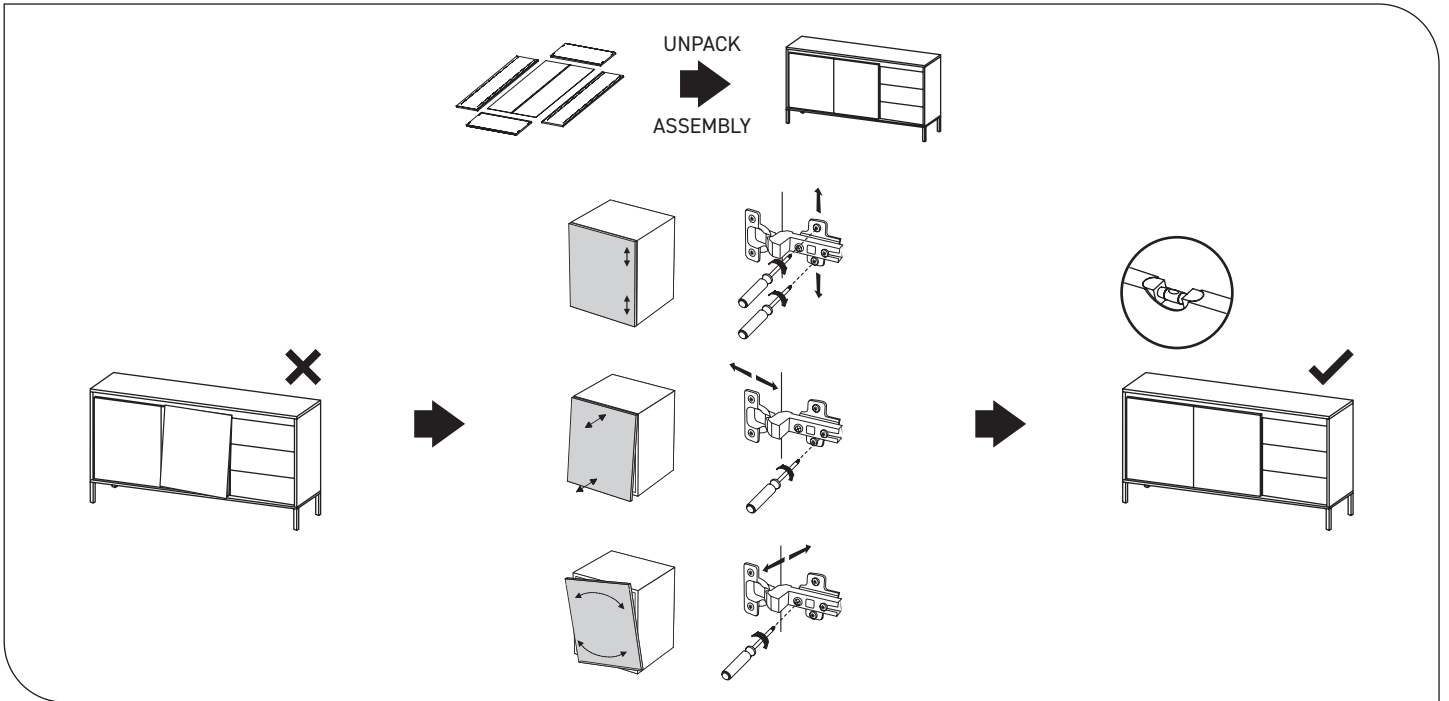
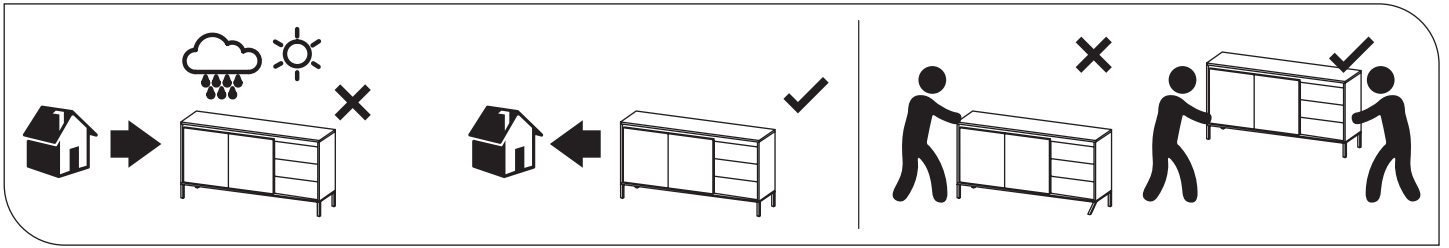

Producător - Produzent - Üretici - Producteur - Výrobce -
 Termelő - Producer - Produttore - Producător - Productor
VENTE-UNIQUE.COM
 9/11 Rue Jacquard - 93310 - Le Pré Saint Gervais - France
 gpsr@vente-unique.com