

K460

v.06

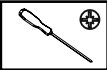
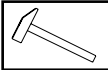
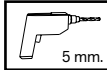

A x 03	B x 03	C x 02	D x 28	E x 01	F x 01	G x 34	H x 08	I x 42
J x 08	K x 06	L x 35	M x 16	N x 40	N x 02	O x 02	P x 24	Q x 40
R x 03	S x 04	T x 02	U x 02	V x 04				

ES

RECOMENDACIONES MONTAJE Y USO

Agrupe y cuente el herraje.
Prepare todas las piezas para el montaje del mueble.
Tenga preparadas las herramientas para el montaje.
Prepare la zona del montaje.
Monte el mueble sobre una moqueta para evitar rayar y dañar la superficie del mueble.
No fuerce los ensamblajes.
Evite colocar el mueble cerca de fuentes de calor.
Evite utilizar trapos, paños o productos de limpieza que puedan dañar la superficie del mueble.
Mueble para uso doméstico en interior de vivienda.

EN

RECOMMENDATIONS FOR ASSEMBLY AND USE

Prepare all the parts of the furniture
Group and count all the hardware
Prepare all the tools for the assembly.
Clear and prepare the assembly area.
Do the assembly on a carpet to avoid damaging the surface of the furniture
Avoid forcing the fittings
Avoid placing the Furniture near any heating source
Do not use cloths or cleaning products to avoid damaging the surface of the furniture
Indoor furniture. Suitable for domestic use.

NL

AANBEVELINGEN MONTAGE EN GEBRUIK

Groeppeer en tel de hardware.
Maak alle stukken klaar voor het monteren van het meubilair.
Bereid alle gereedschappen voor de montage voor.
Maak het montagegebied schoon en bereid het voor.
Monteer het meubel op een tapijt om krassen te voorkomen en het oppervlak van het meubilair beschadigen.
Forceer de montage niet.
Plaats het meubilair niet in de buurt van warmtebronnen.
Vermijd het gebruik van vossen, doeken of schoonmaakmiddelen die het oppervlak van het meubilair kunnen beschadigen.
Meubilair voor huishoudelijk gebruik binnenshuis.

FR

CONSEILS DE MONTAGE CONSEILS POUR L'USAGE

Préparez les différents parts du meuble
Regrouper et compter toute la quincaillerie
Préparez l'outillage nécessaire
Aménagez-vous une area de montage
Faire le montage sur moquette afin de protéger le meuble des rayures
Ne forcer pas le montage
Évitez placer le meuble près des sources de chaleur
Évitez utiliser de chiffons ou des produits de nettoyage pour ne pas rayer la superficie du meuble
Meuble d'usage domestique pour l'intérieur de la maison.

PT

RECOMENDAÇÕES PARA MONTAGEM E USO

Prepare todas as peças para a montagem de móveis
Reagrupar e contar o hardware
Preparar as ferramentas de montagem
Preparar a área de montagem
Montar as peças em tapete para evitar riscos e danos na superfície dos móveis
Não force as assembleias
Não colocar móveis perto de fontes de calor
Evitar o uso de panos, trapos ou produtos de limpeza que possam riscar o móvel.
Móveis para uso doméstico no interior da casa.

IT

CONSIGLI INSTALLAZIONE ED USO

Preparare tutti componenti del mobile per il montaggio
Ordinate la ferramenta
Preparate tutti gli attrezzi necessari per il montaggio
Preparare l'area di montaggio
Fare il montaggio su un tappeto per evitare danneggiare le superfici dei mobili
Non forzare i componenti
Evitare posizionare il mobile in prossimità di fonti di calore
Non usare panni né detersivi né solventi che possano danneggiare le superficie dei mobili
Mobili per uso domestico all'interno della casa.

DE

MONTAGEHINWEISE-GEBRAUCHSHINWEISE

Identifizieren Sie die Einzelteile
Überprüfen Sie Die Anzahl der einzelnen Beschlagteile
Legen Sie das notwendige Werkzeug bereit
Bereiten die Montagefläche
Montieren Sie das Möbel auf einem Teppich, sauberen Untergrund
Niemaals die verbindungen zu start anziehen
Nicht neben Wärmequellen platzieren
Vermeiden Sie Tücher und keinesfalls scharfe oder ätzende Reinigungsmittel.
Möbel für den Gebrauch im Haus geeignet.

PL

ZALECENIA MONTAŻ I UŻYTKOWANIE

Grupuj i policz sprzęt.
Przygotuj wszystkie elementy do montażu mebli.
Przygotuj narzędzia do montażu.
Przygotuj miejsce montażu.
Zamontuj meble na dywanie, aby uniknąć zarysowań i uszkodzeń powierzchni mebli.
Nie wymuszaj montażu.
Unikaj umieszczania mebli w pobliżu źródeł ciepła.
Unikaj używania szmat, ściereczek i środków czyszczących które mogą uszkodzić powierzchnię mebla.
Meble do użytku domowego w domu.

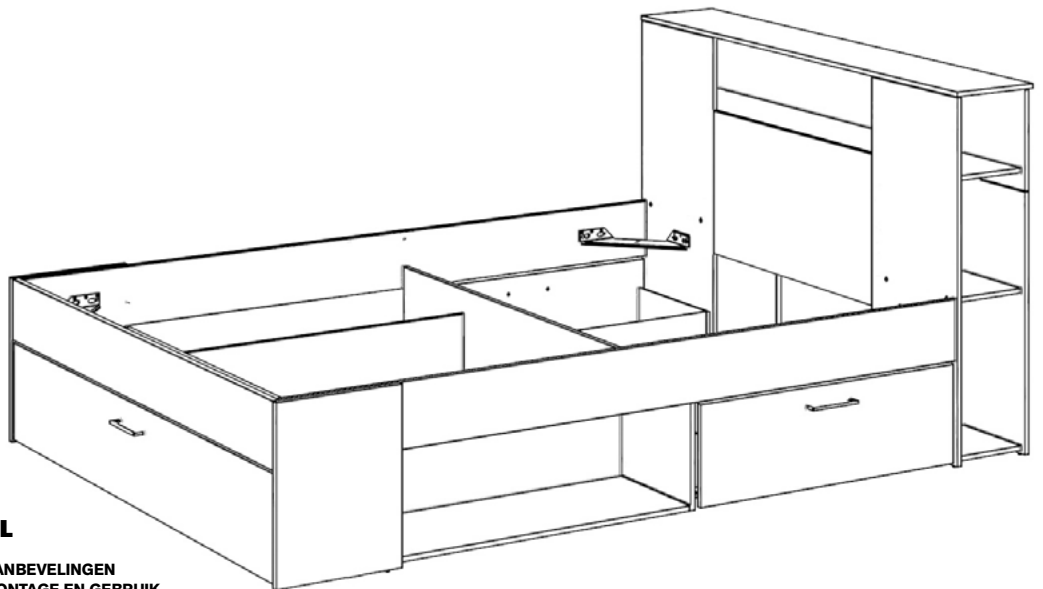

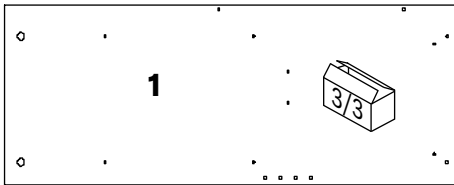

934 x 368 mm.

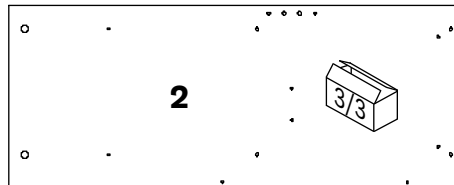

934 x 368 mm.

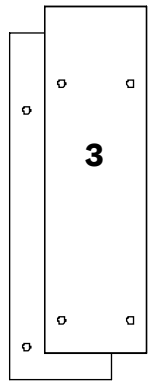

718 x 200 mm.

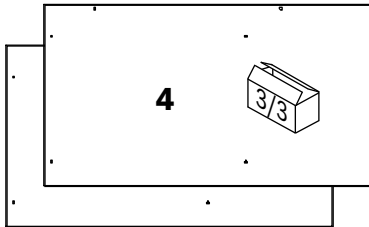

675 x 368 mm.

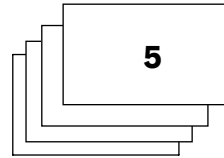

339 x 200 mm.

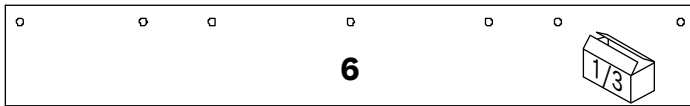

1446 x 200 mm.

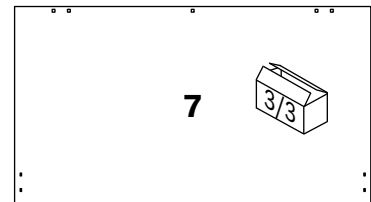

734 x 399 mm.

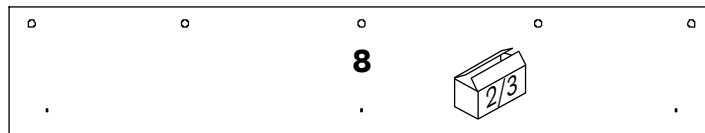

1470 x 259 mm.

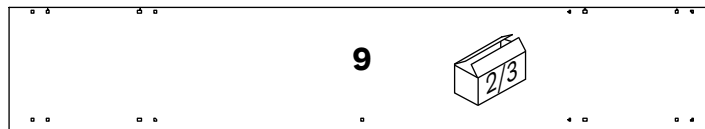

1472 x 246 mm.

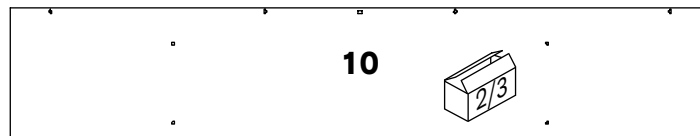

1458 x 266 mm.

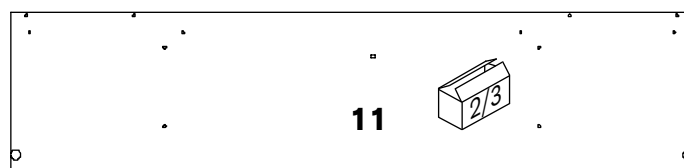

1420 x 330 mm.

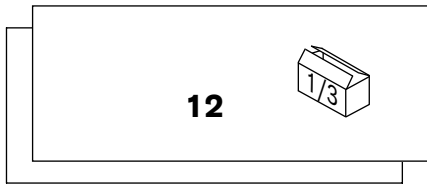

821 x 311 mm.

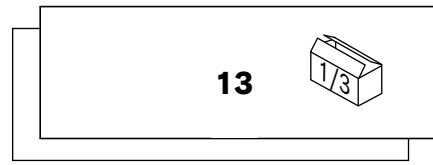

821 x 265 mm.

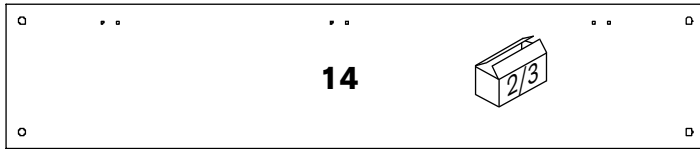

1458 x 292 mm.

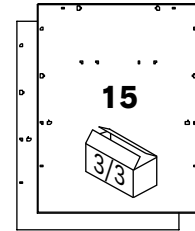

427 x 330 mm.

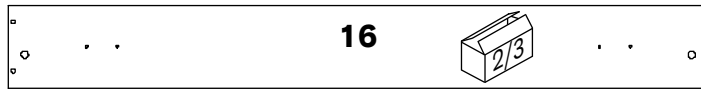

1458 x 161 mm.

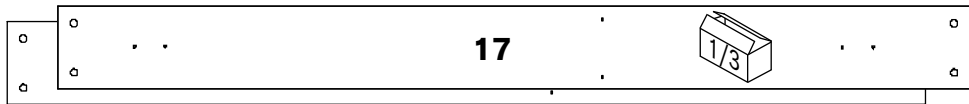

1920 x 160 mm.

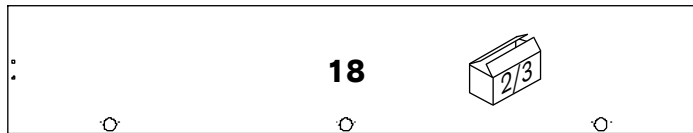

1452 x 254 mm.

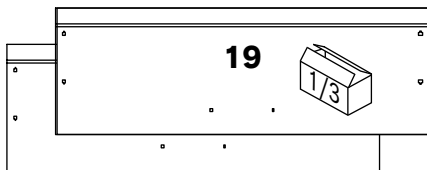

770 x 254 mm.

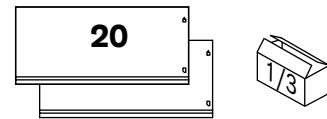

350 x 150 mm.

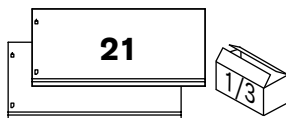

350 x 150 mm.

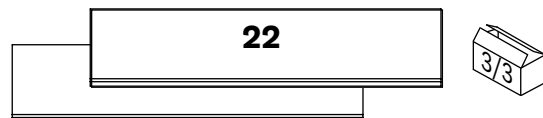

726 x 150 mm.

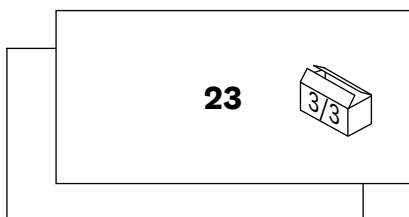

737 x 351 mm.

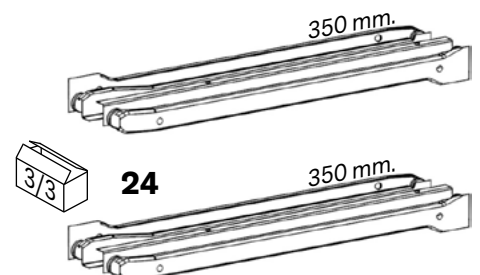

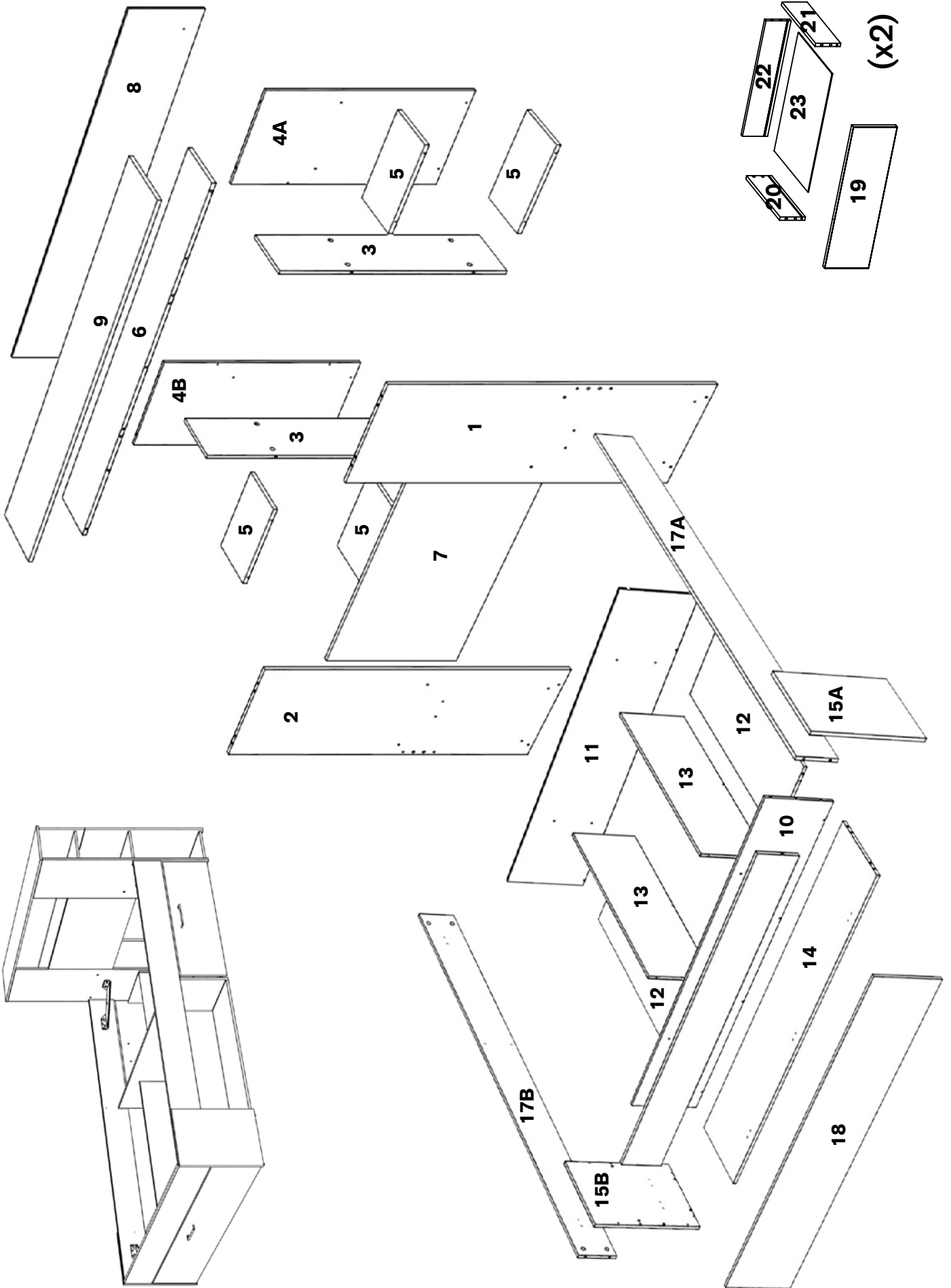

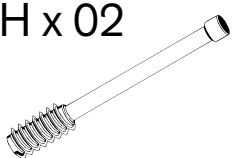
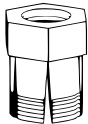
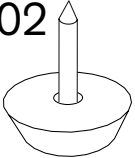

(x2)

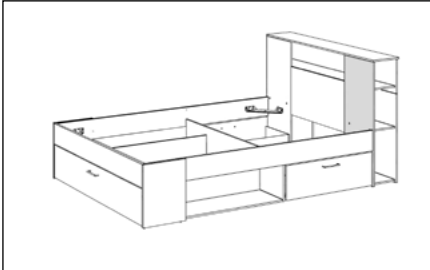
01 H x 02  J x 02  P x 02 



V x 02
 
 6,3 x 11mm.

P

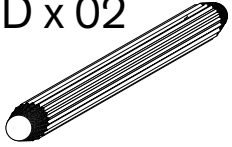
D x 02 

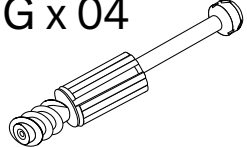
G x 04 

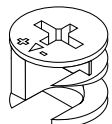
I x 02 

G

I

D

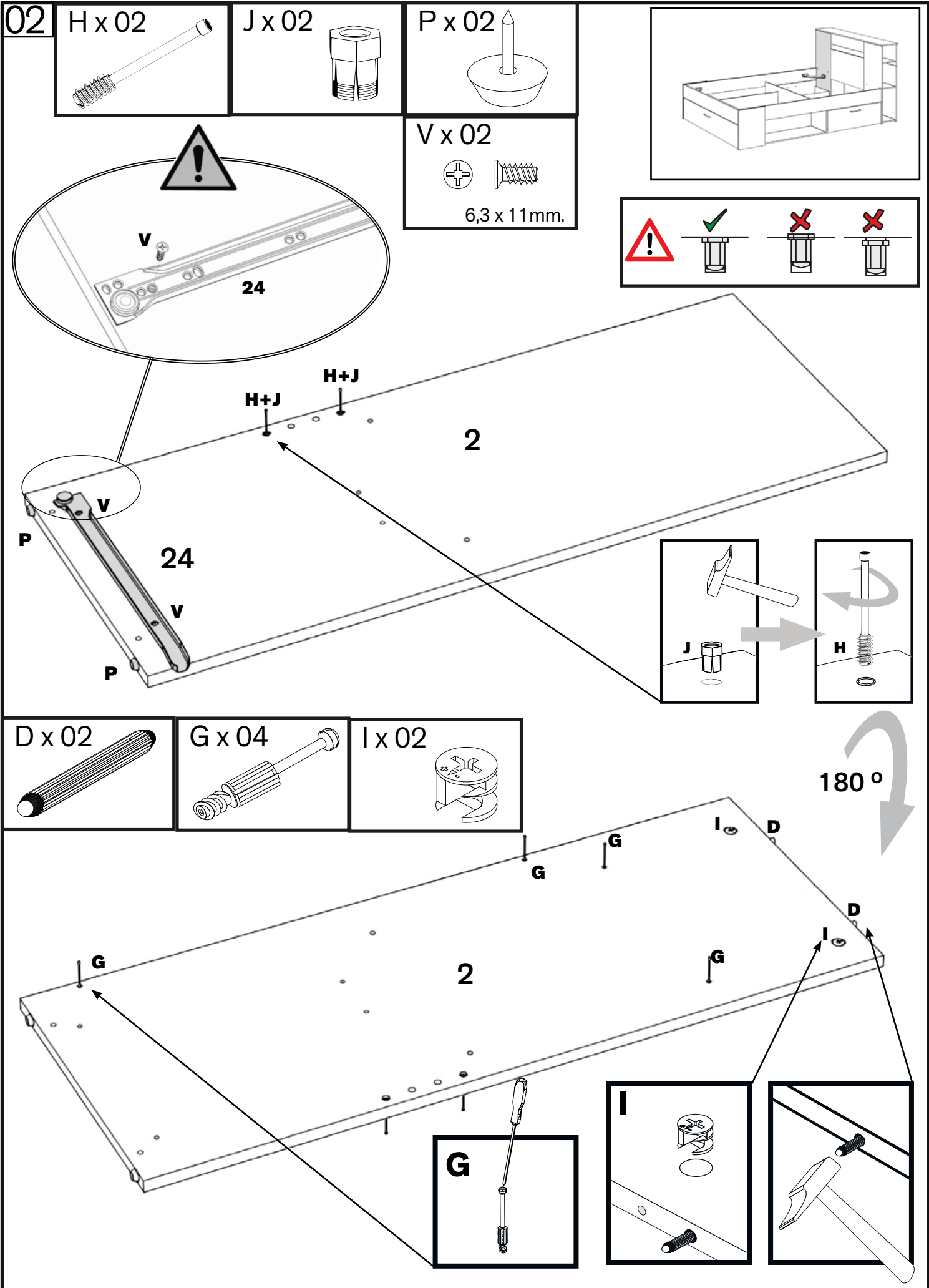

03

I x 08

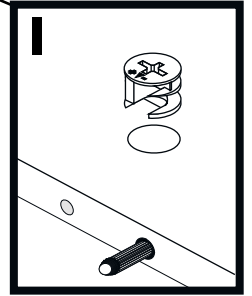
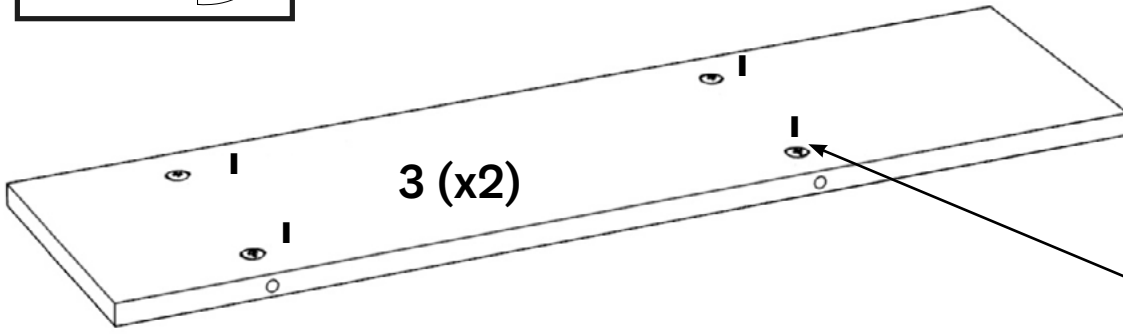
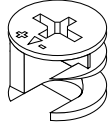

04

G x 02

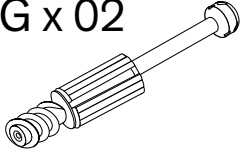

P x 02

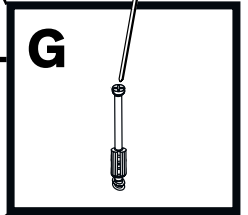
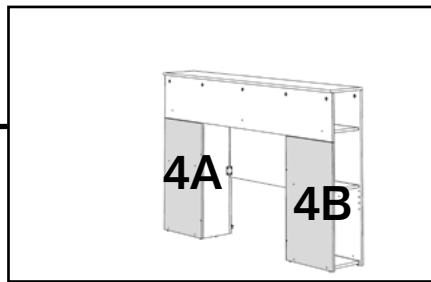
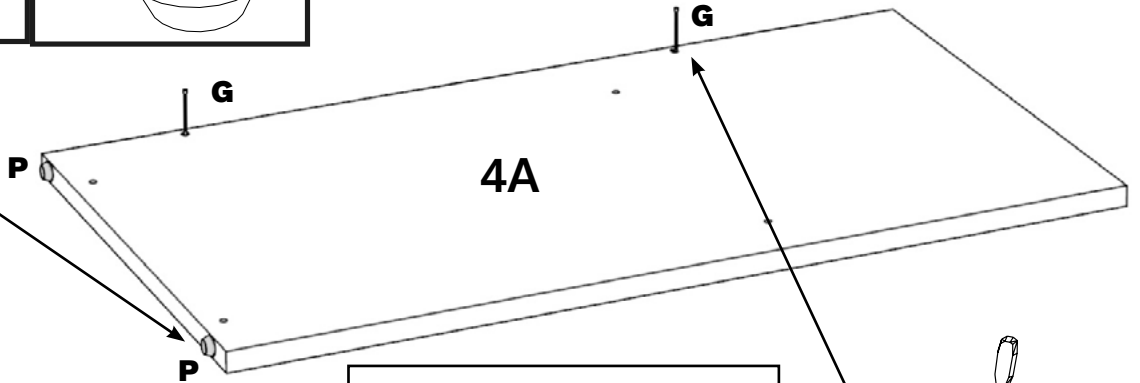
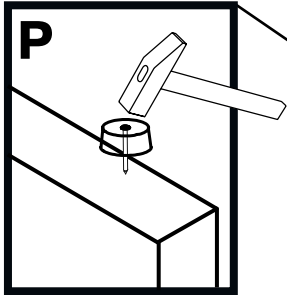
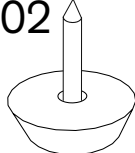

05

G x 02

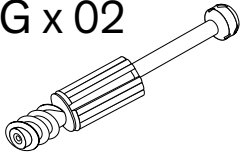

P x 02

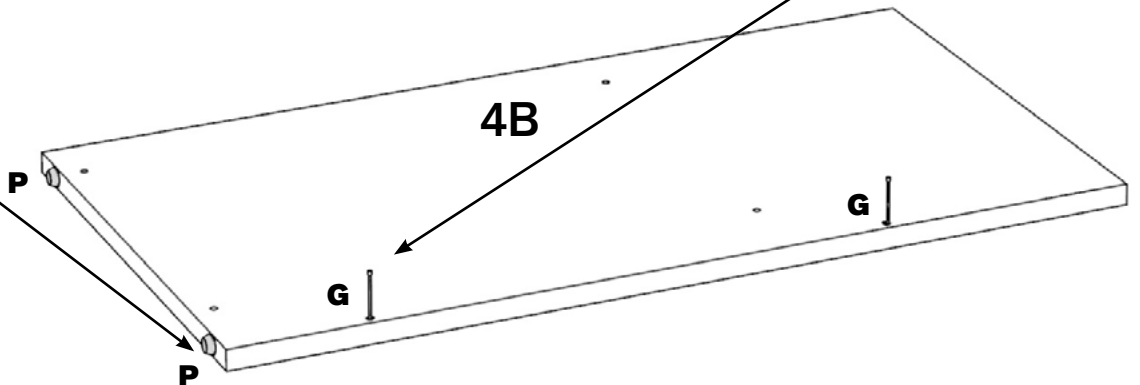
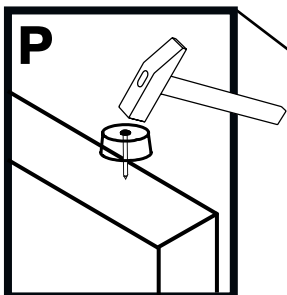

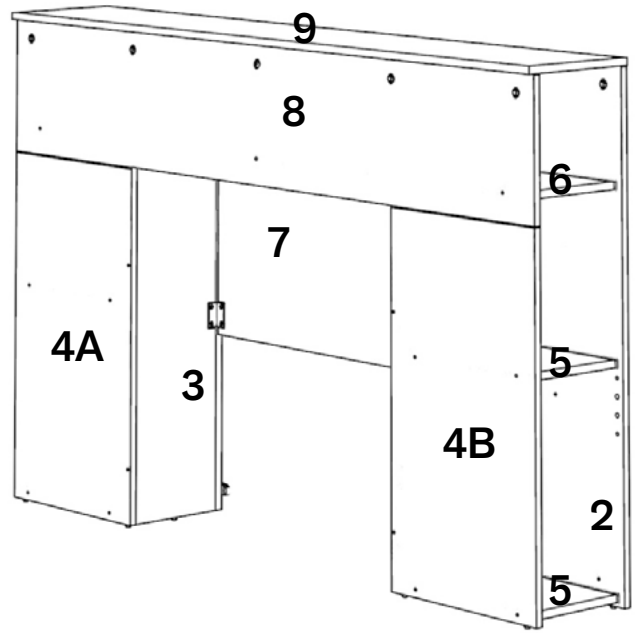
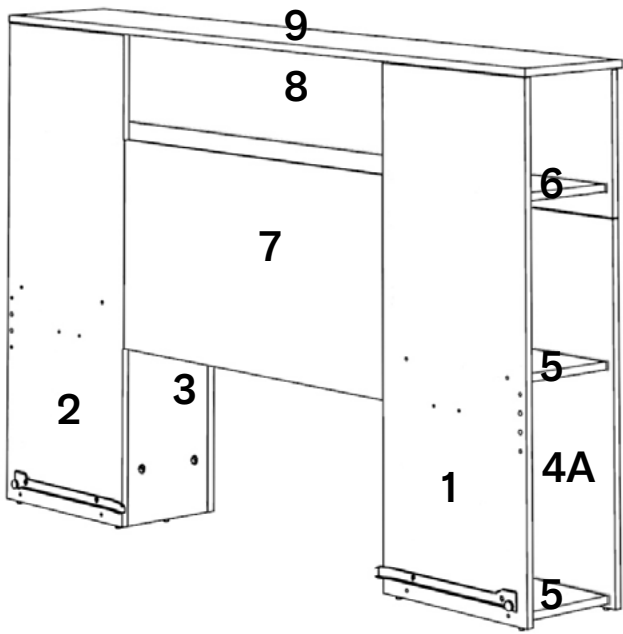

06

F x 01

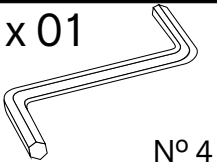

N° 4

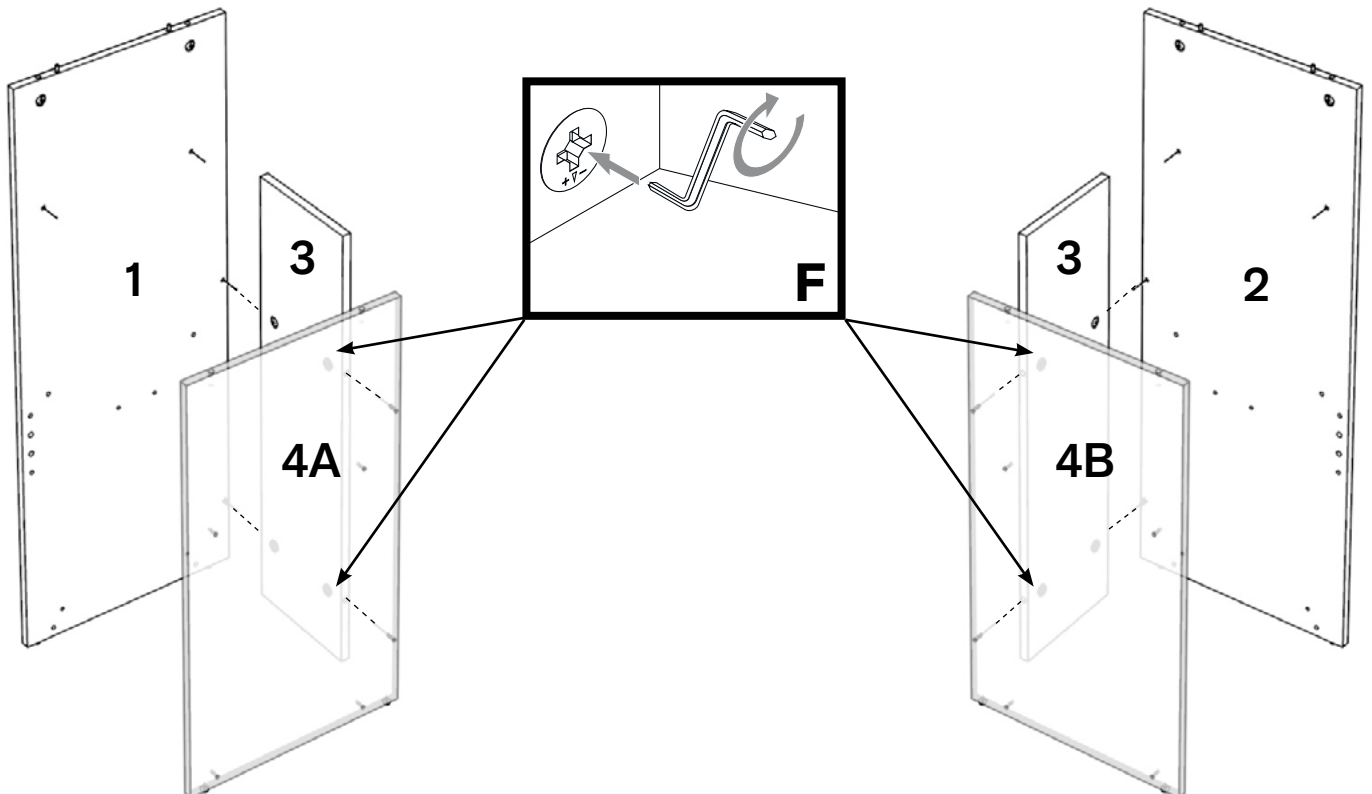

07

E x 01

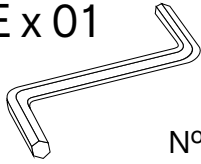

N° 3

L x 16



5 x 50 mm.

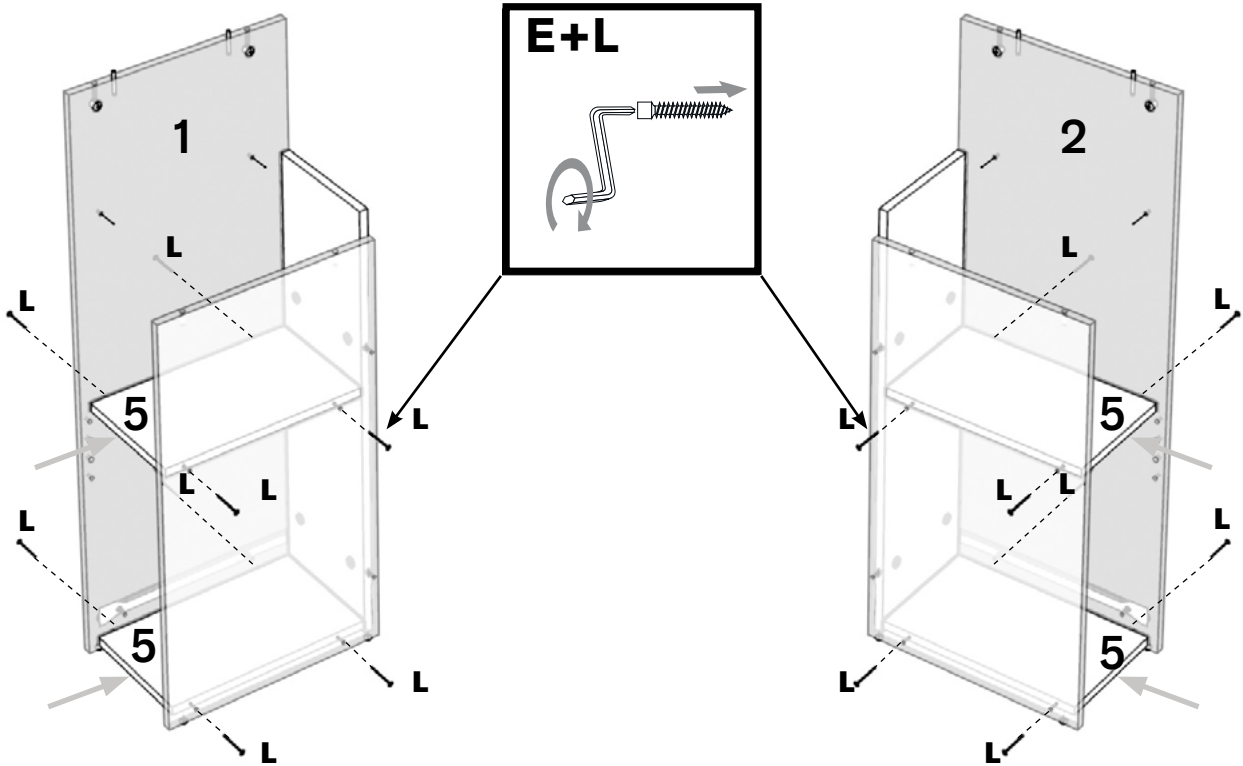

08

D x 02

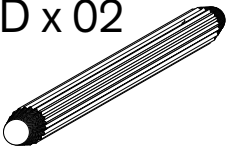

I x 07

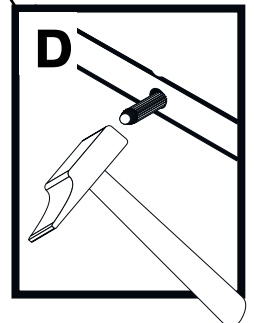
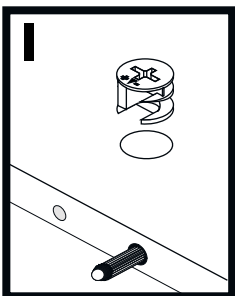
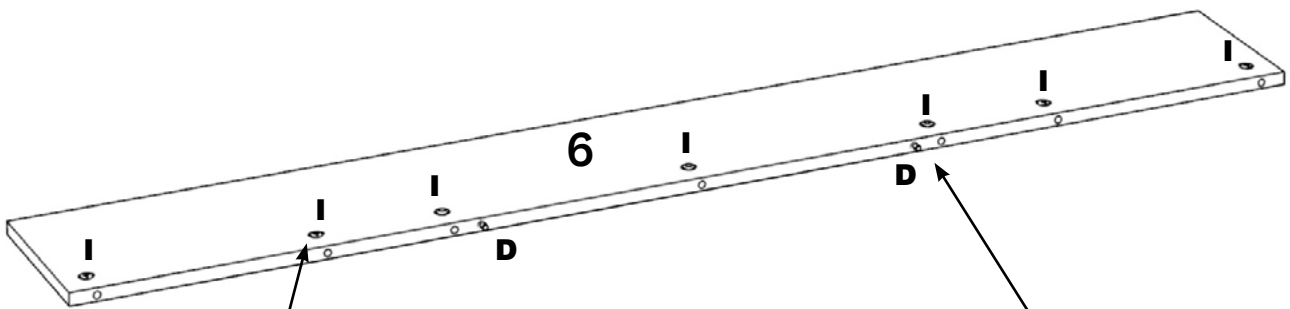
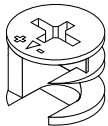

09

F x 01

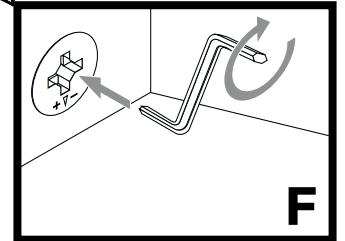
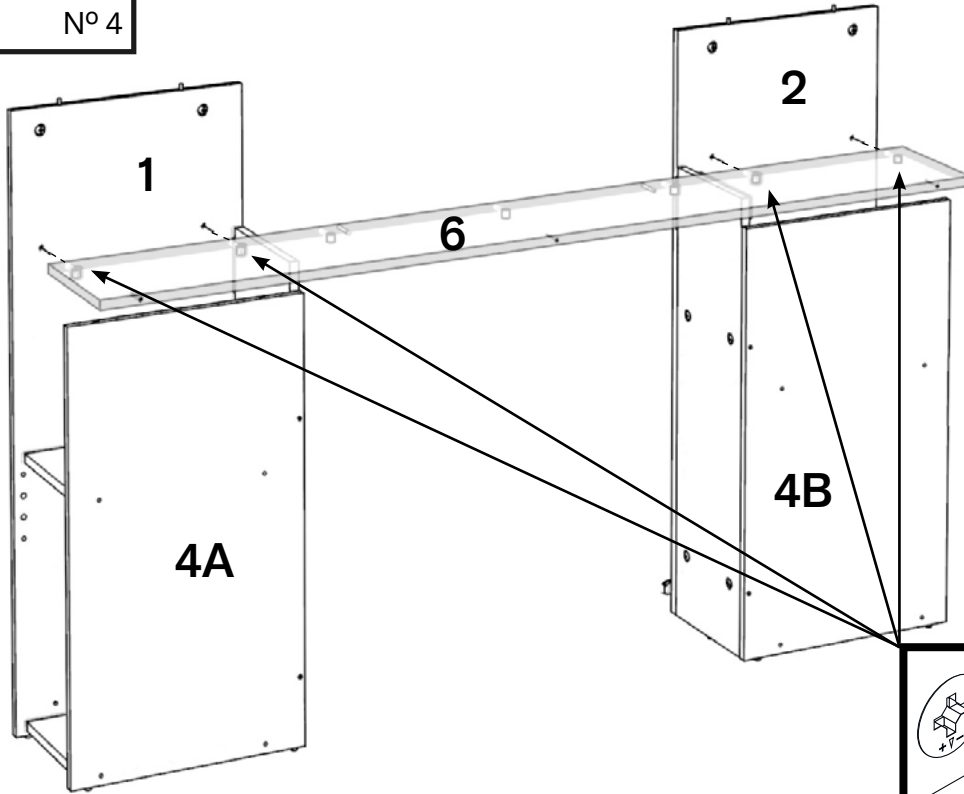
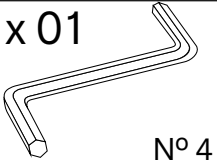

10

G x 03

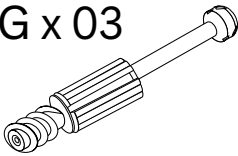

N x 04



3.5 x 15 mm.

C x 02

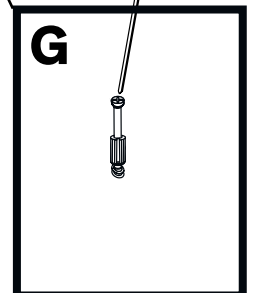
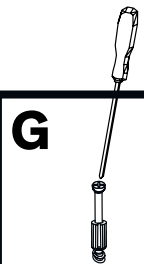
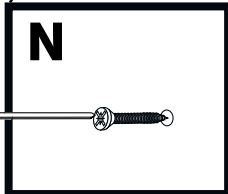
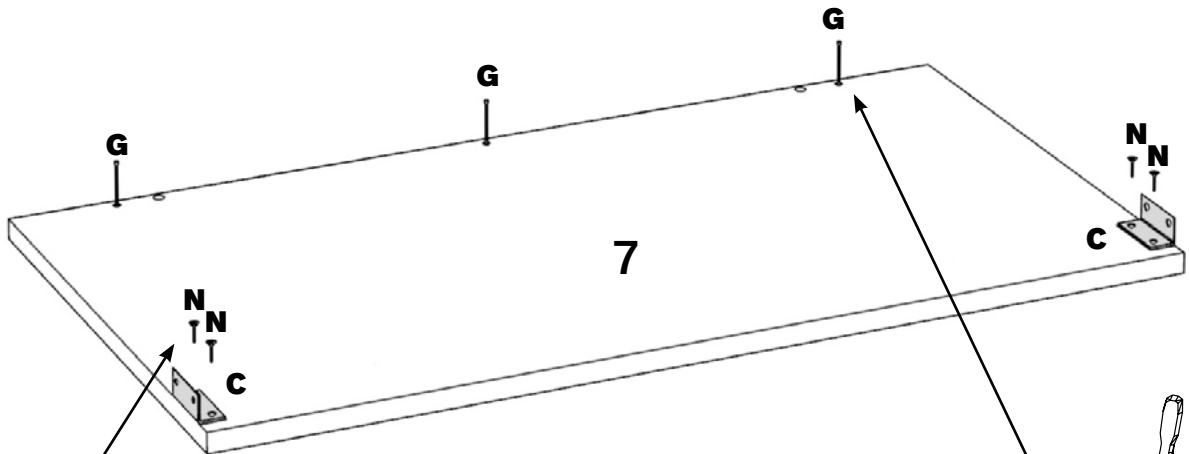
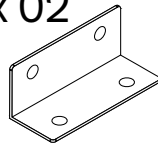

11

F x 01

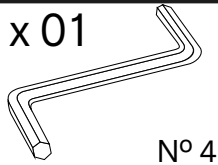

N x 04



3.5 x 15 mm.

180°

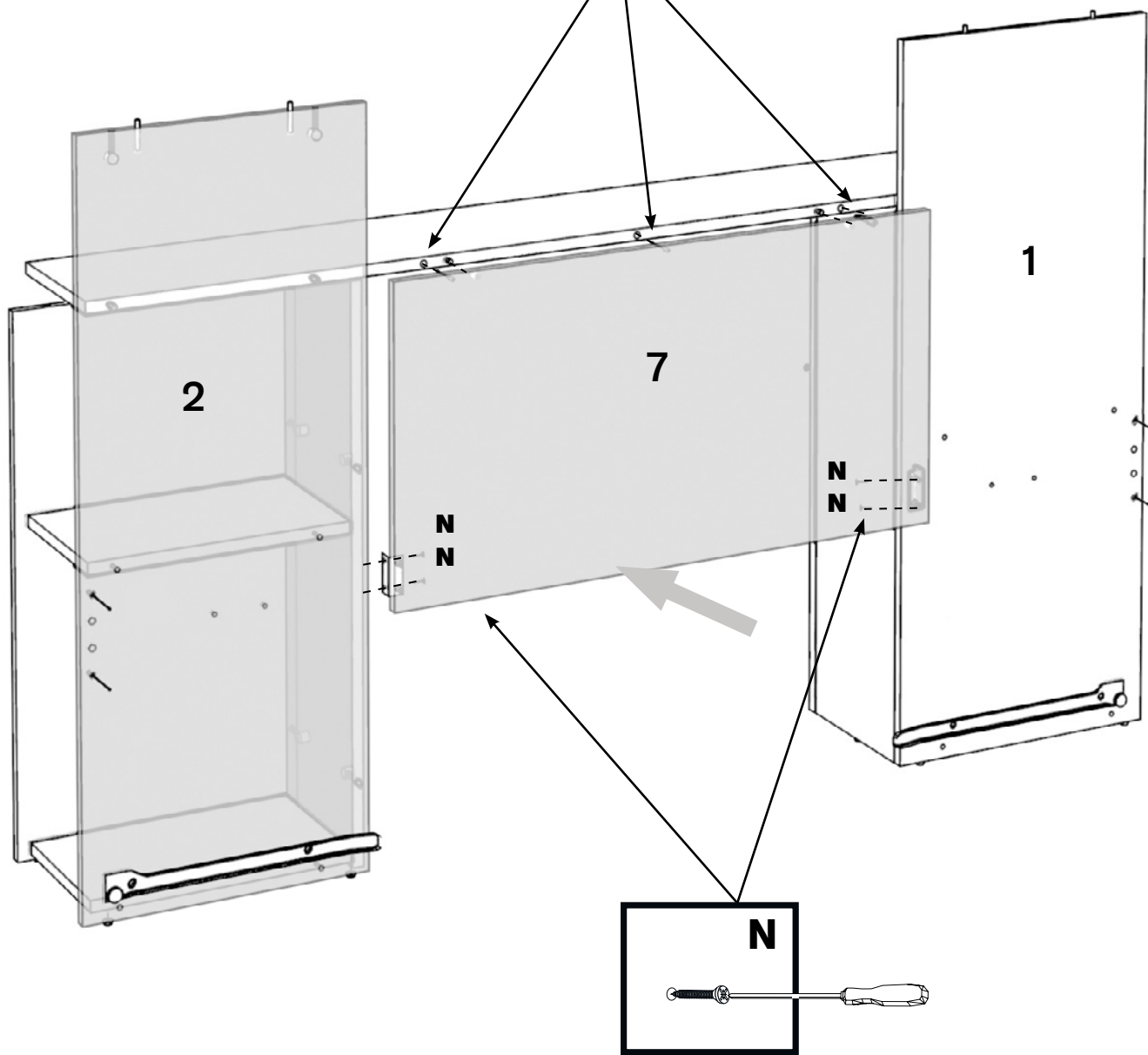
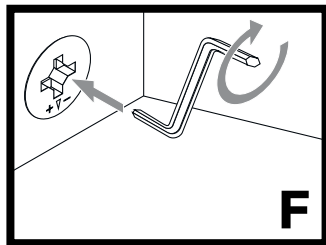
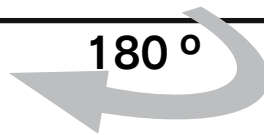

12

D x 08

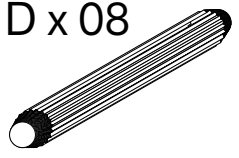

I x 05

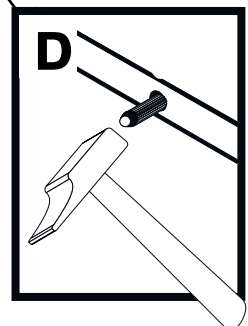
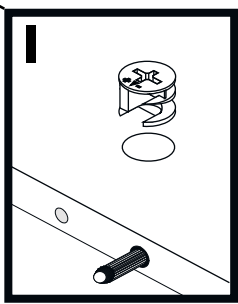
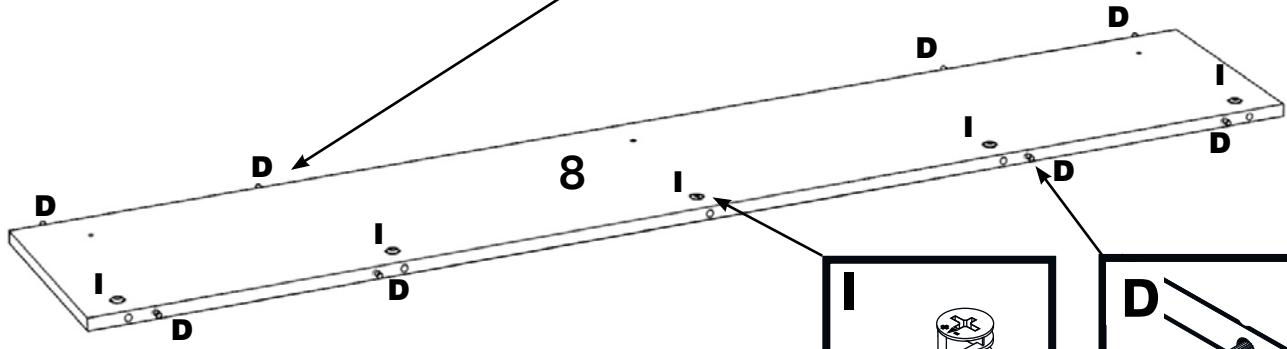
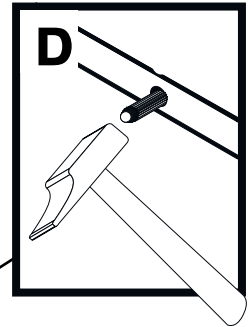
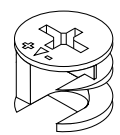

13

G x 09

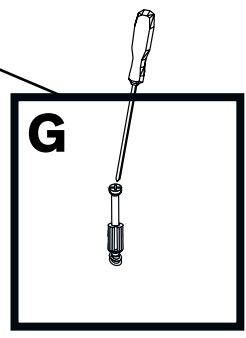
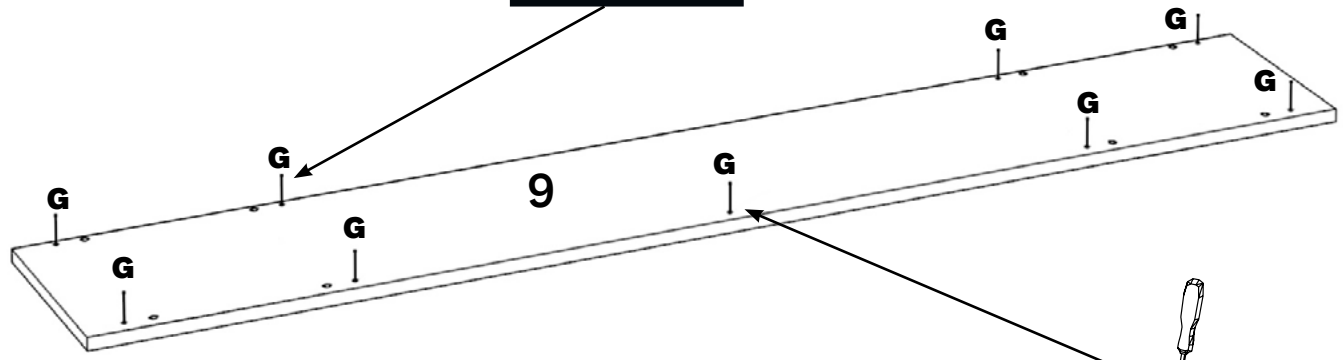
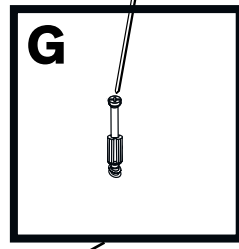
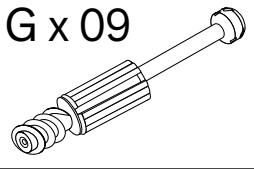

14

E x 01

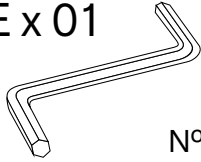

N° 3

F x 01

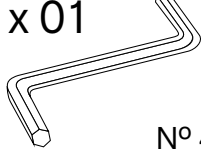

N° 4

L x 03



5 x 50 mm.

Q x 04



17 mm.

180°

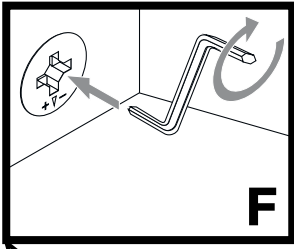
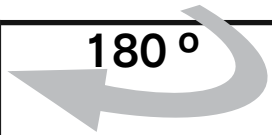

F

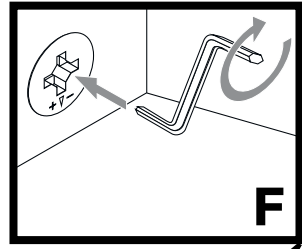

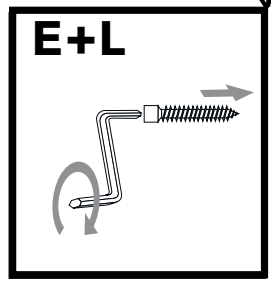
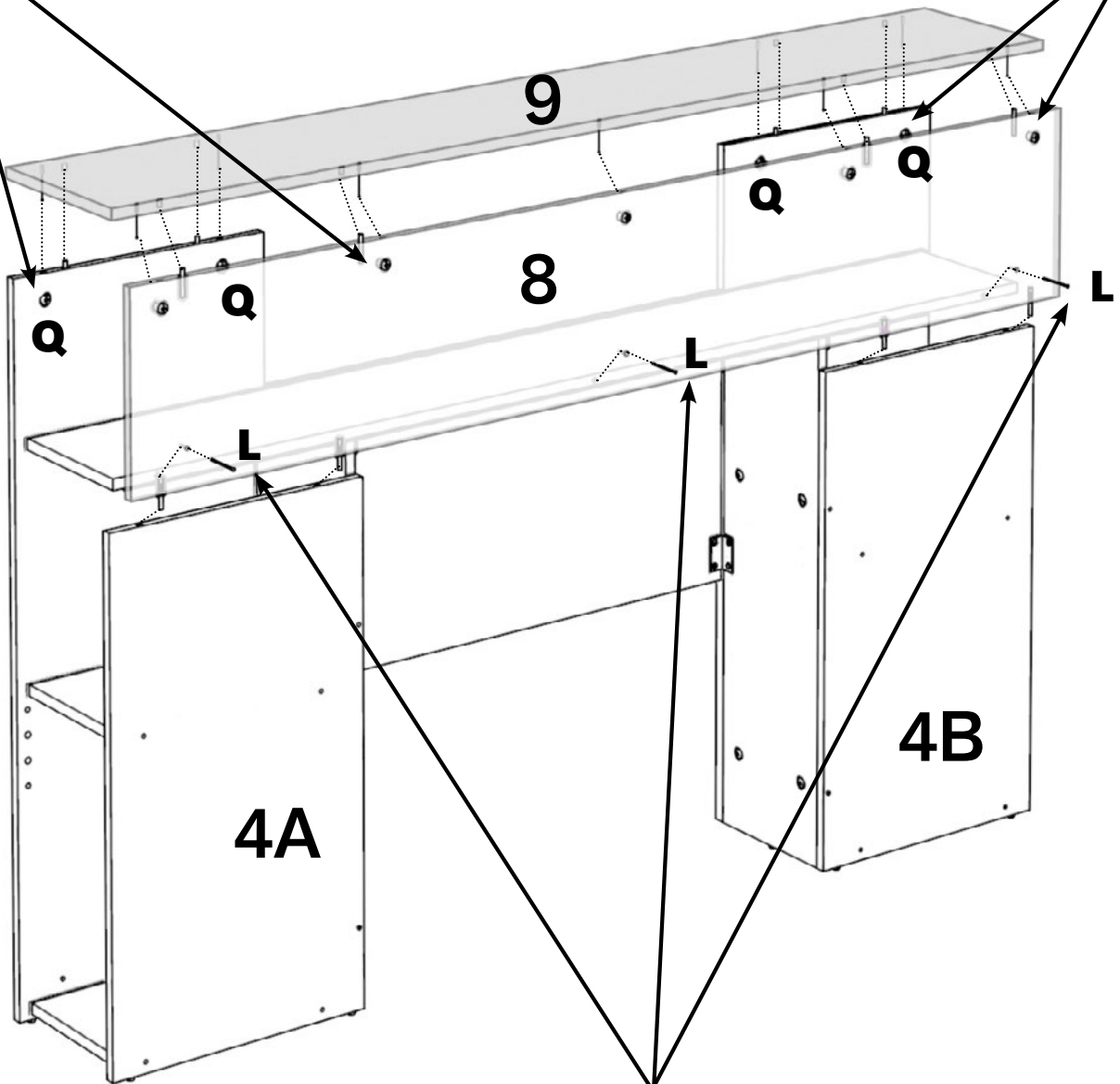

F



E+L

15

K x 04

 4 x 27 mm.

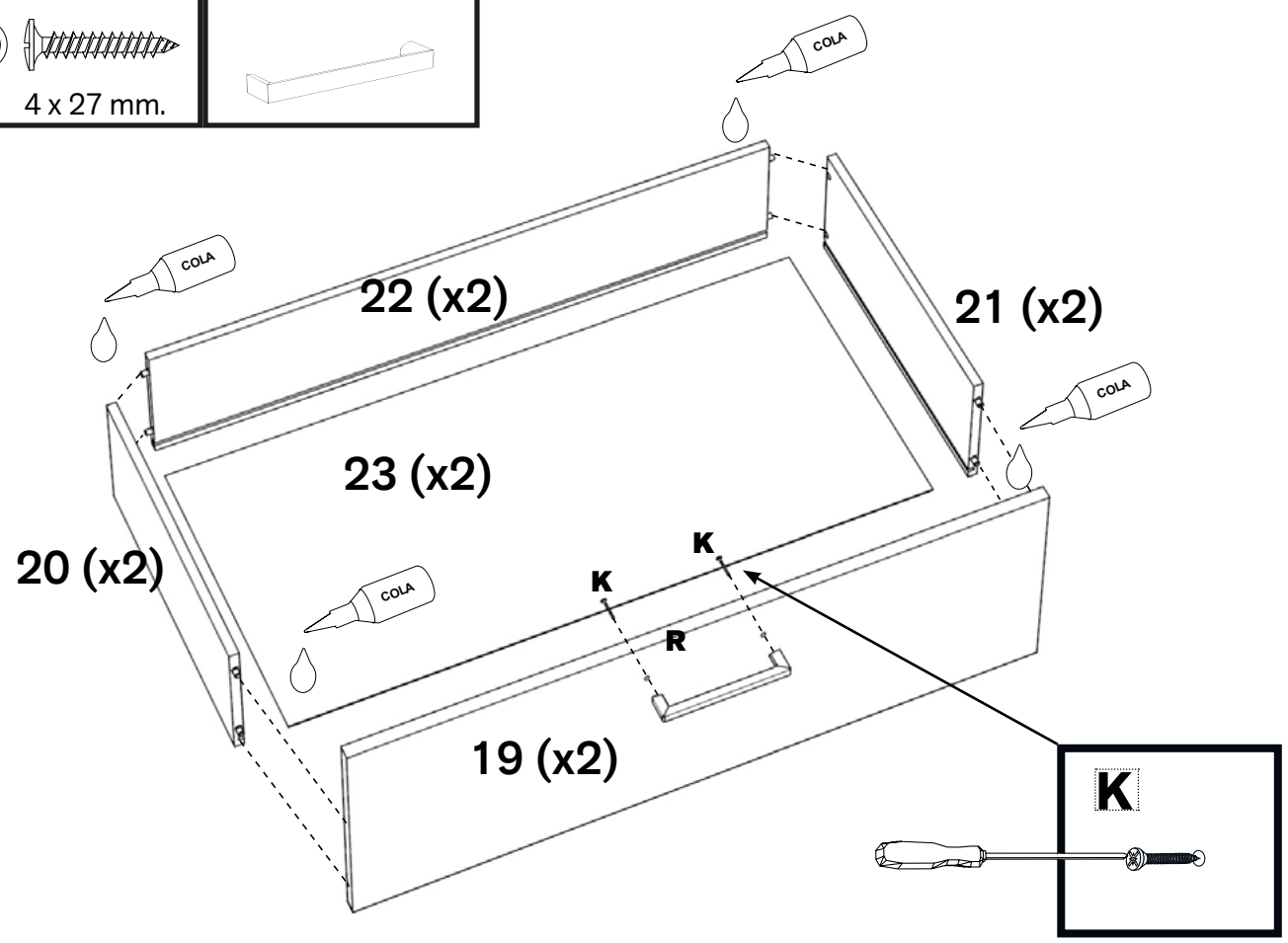
R x 02

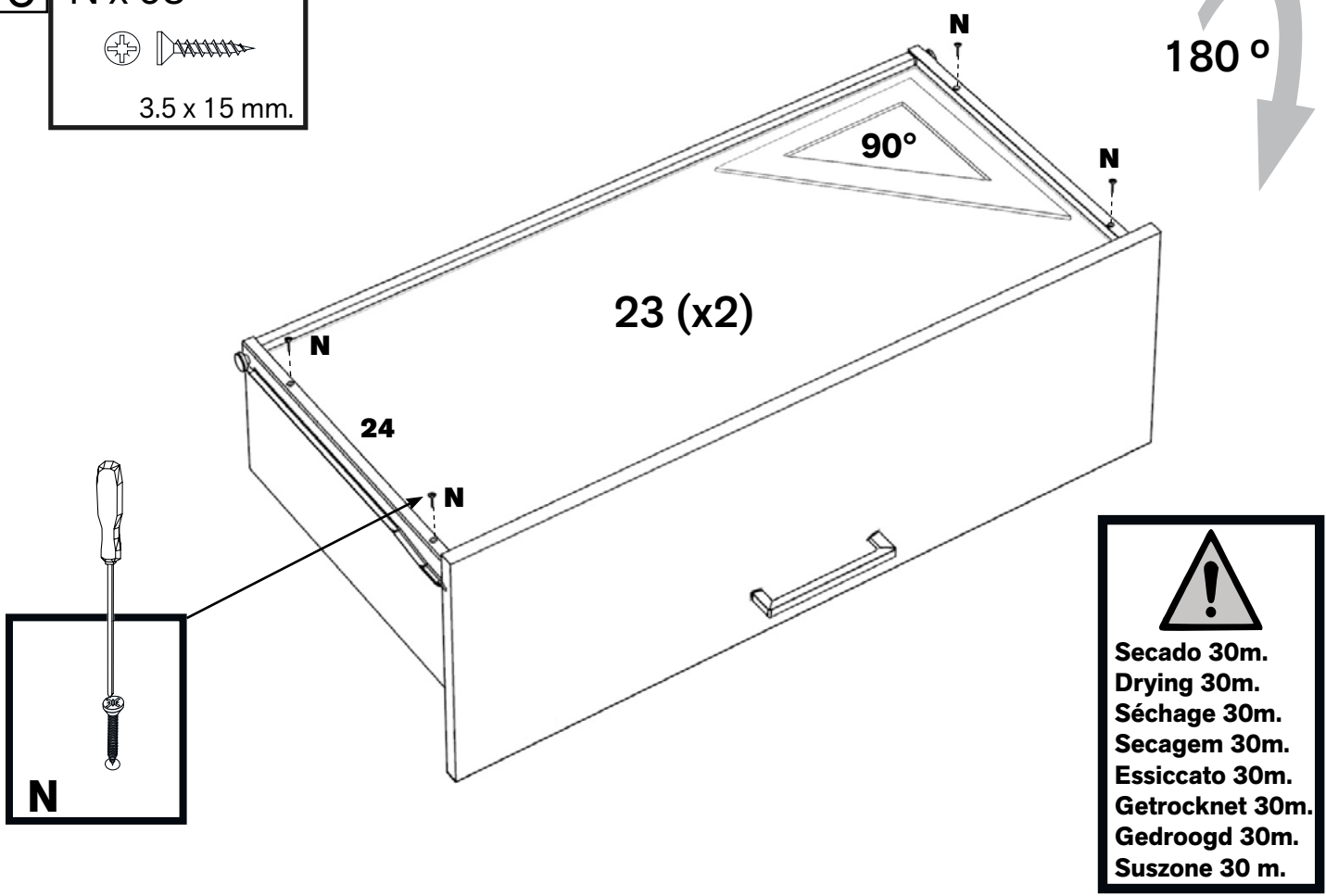

16

N x 08

 3.5 x 15 mm.

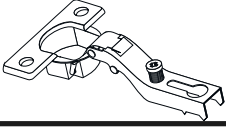

17

A x 03



K x 02

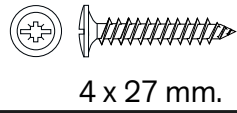

4 x 27 mm.

N x 06



3.5 x 15 mm.

R x 01

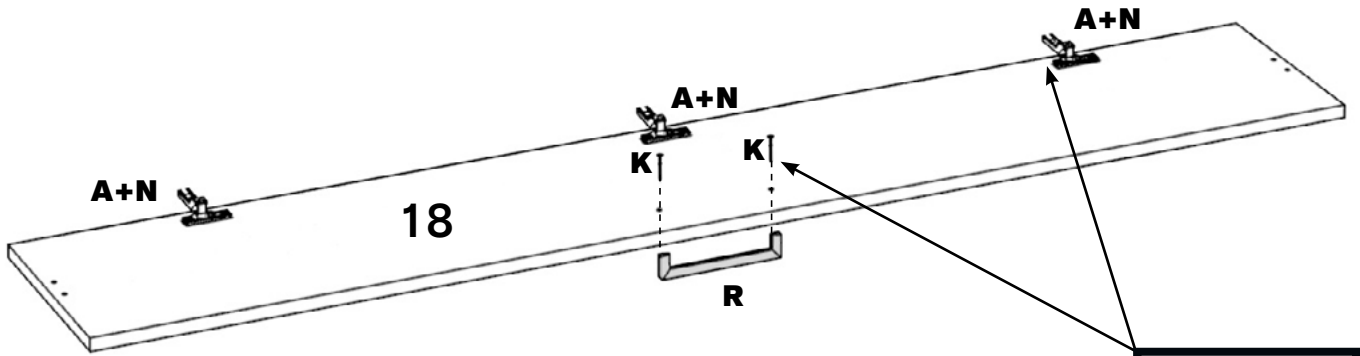

18

D x 02

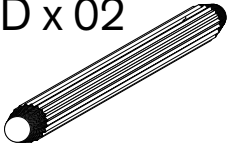

P x 03

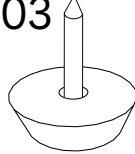

I x 04

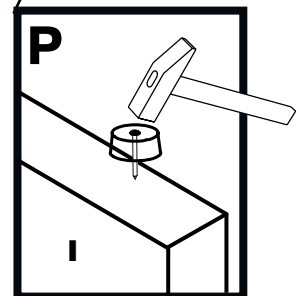
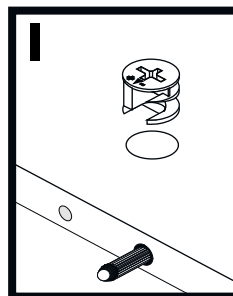
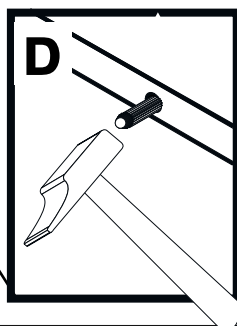
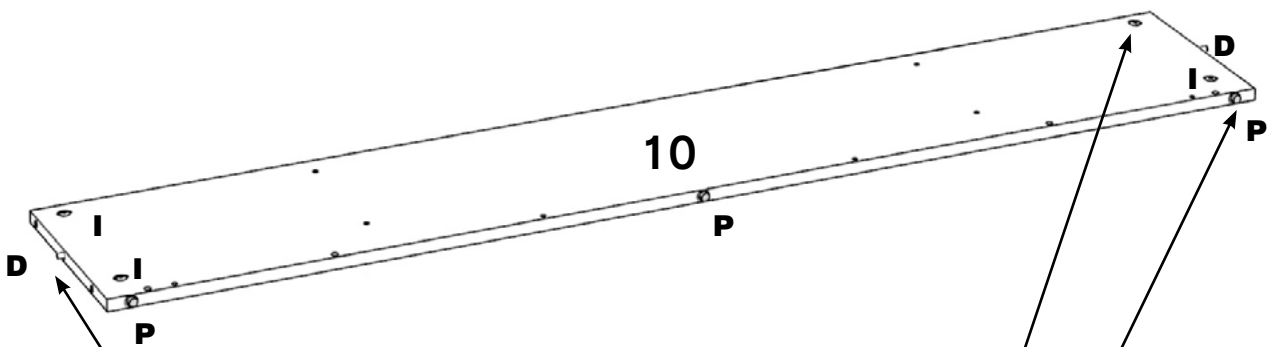
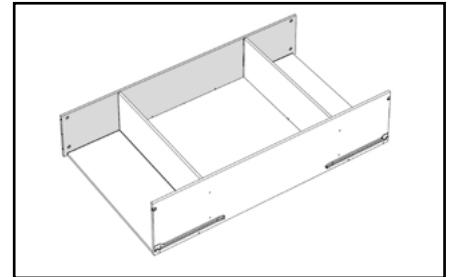
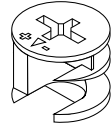

19

N x 04

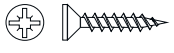

3.5 x 15 mm.

Ñ x 02

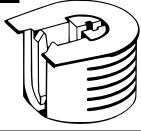

P x 03

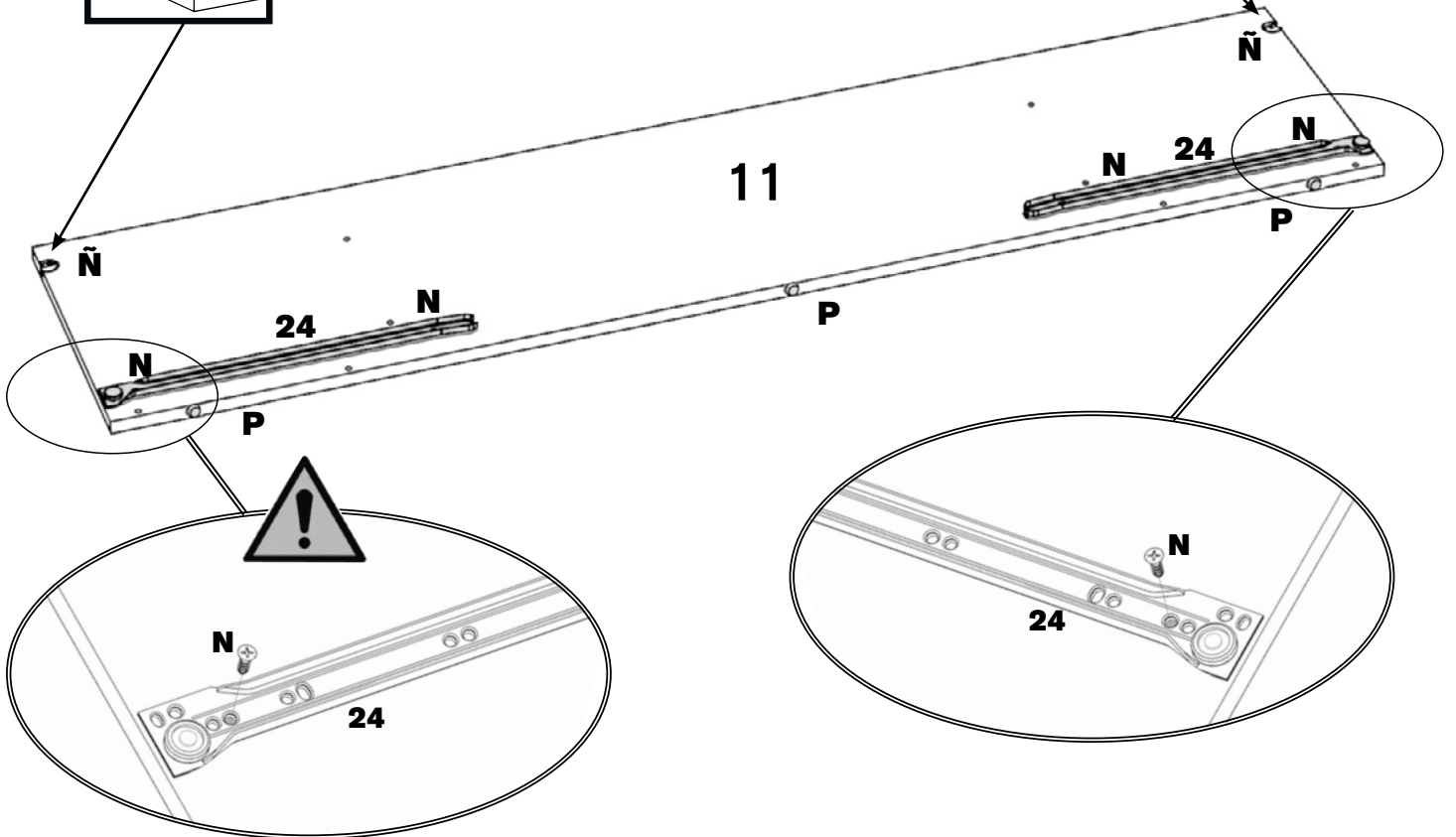
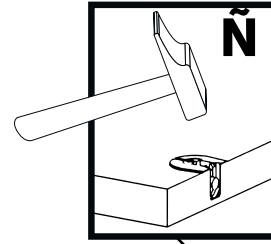
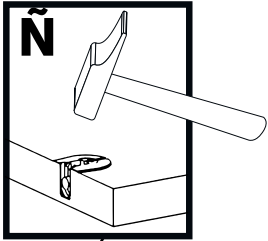
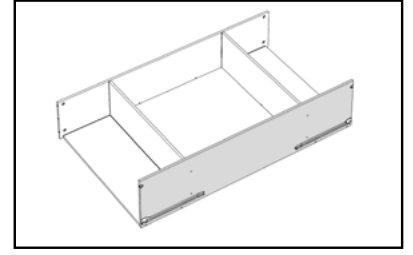
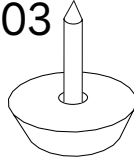

20

D x 04

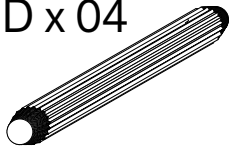

P x 04

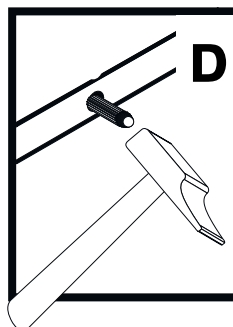
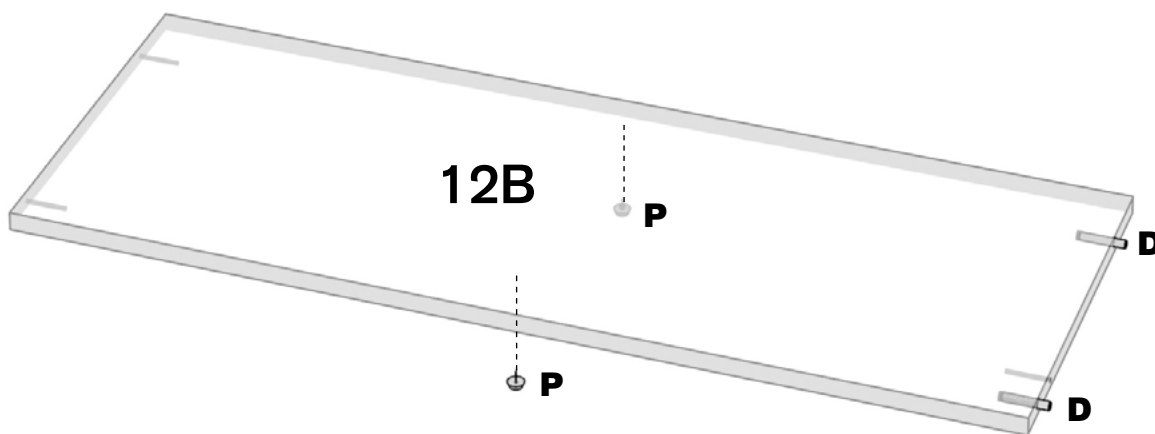
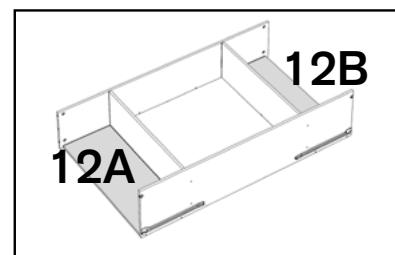
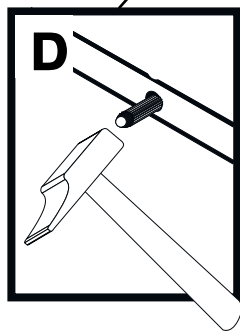
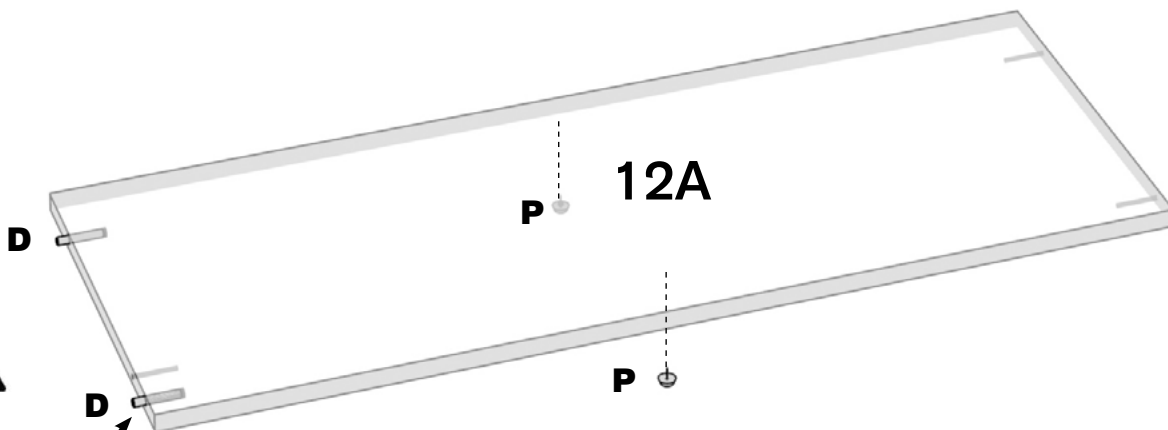

21

E x 01

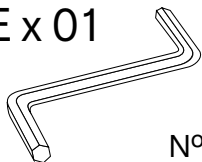

Nº 3

L x 14



5 x 50 mm.

E+L

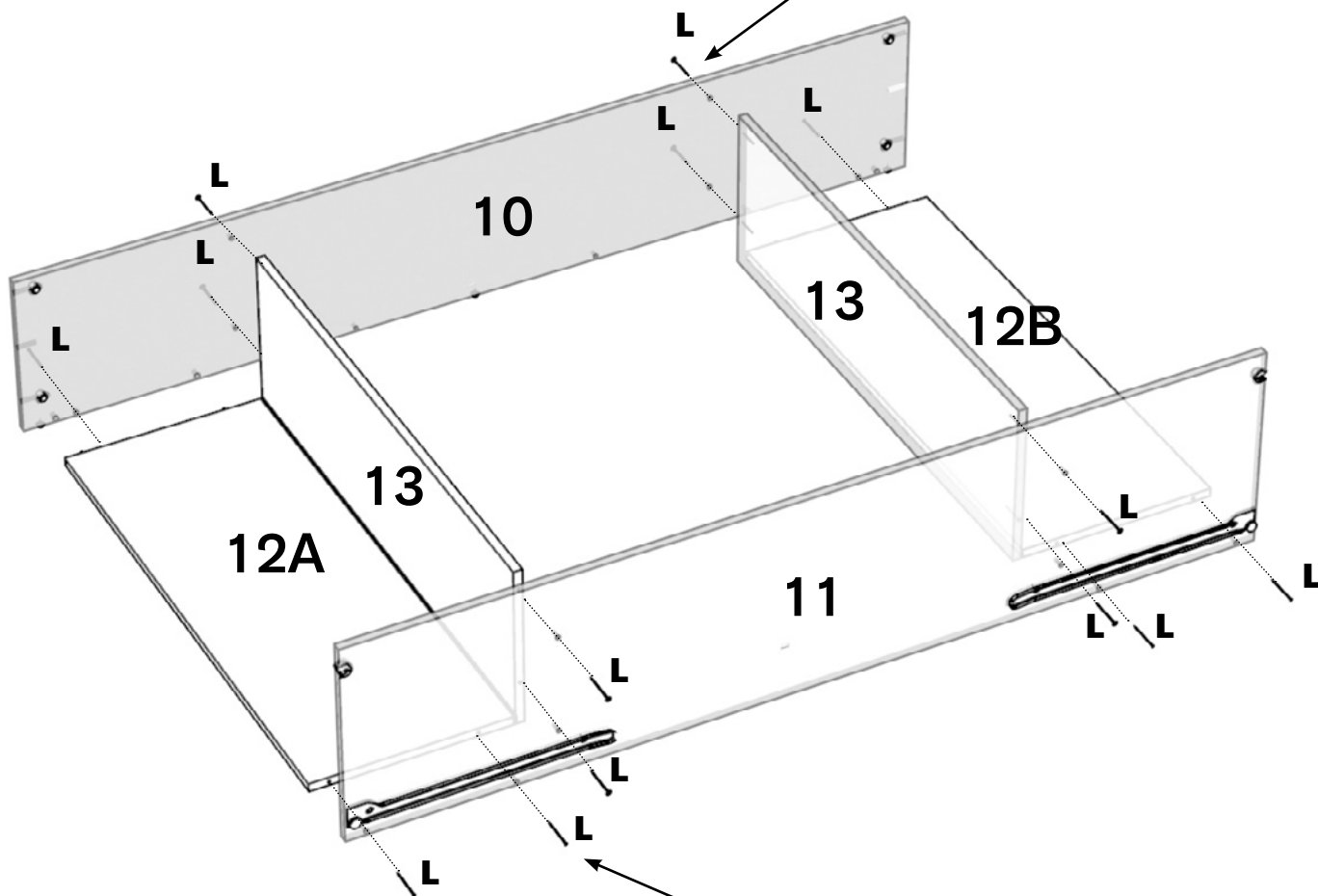
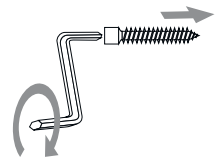

E+L

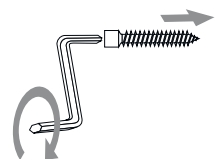

22

B x 03

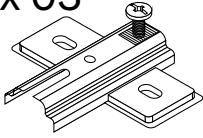

D x 04

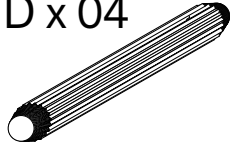

I x 04

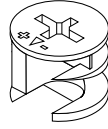

N x 06

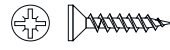

3.5 x 15 mm.

P x 02

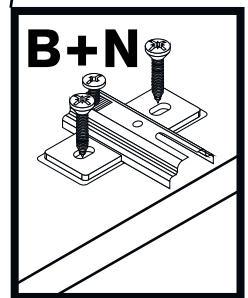
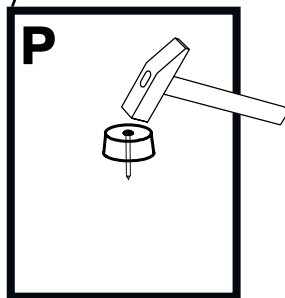
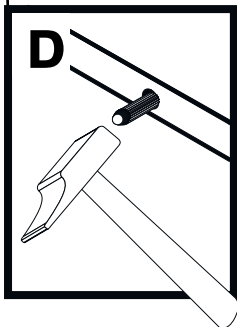
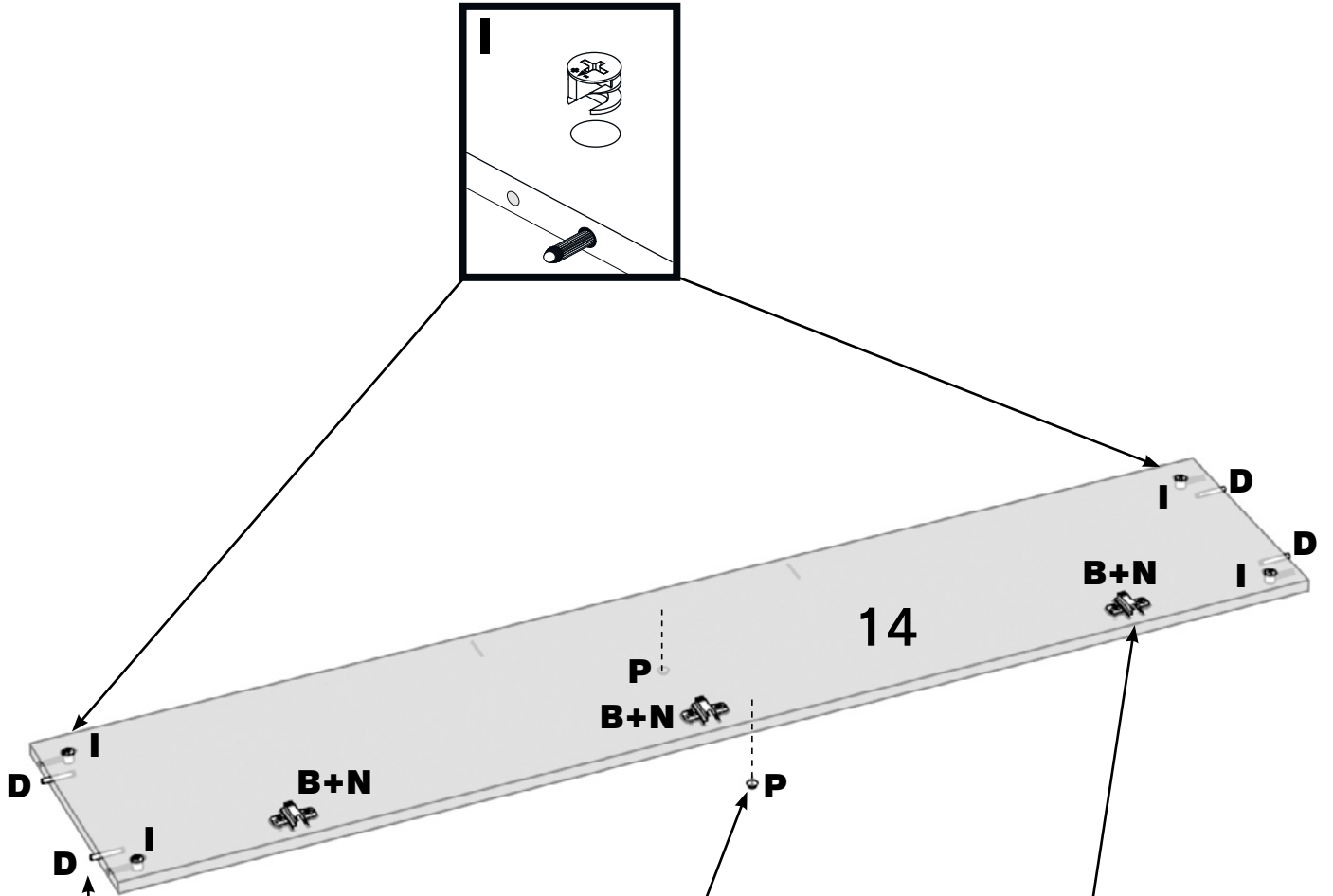
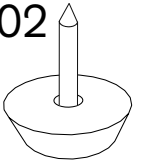

23

E x 01

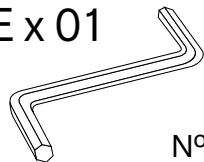

Nº 3

L x 02

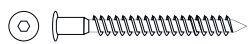

5 x 50 mm.

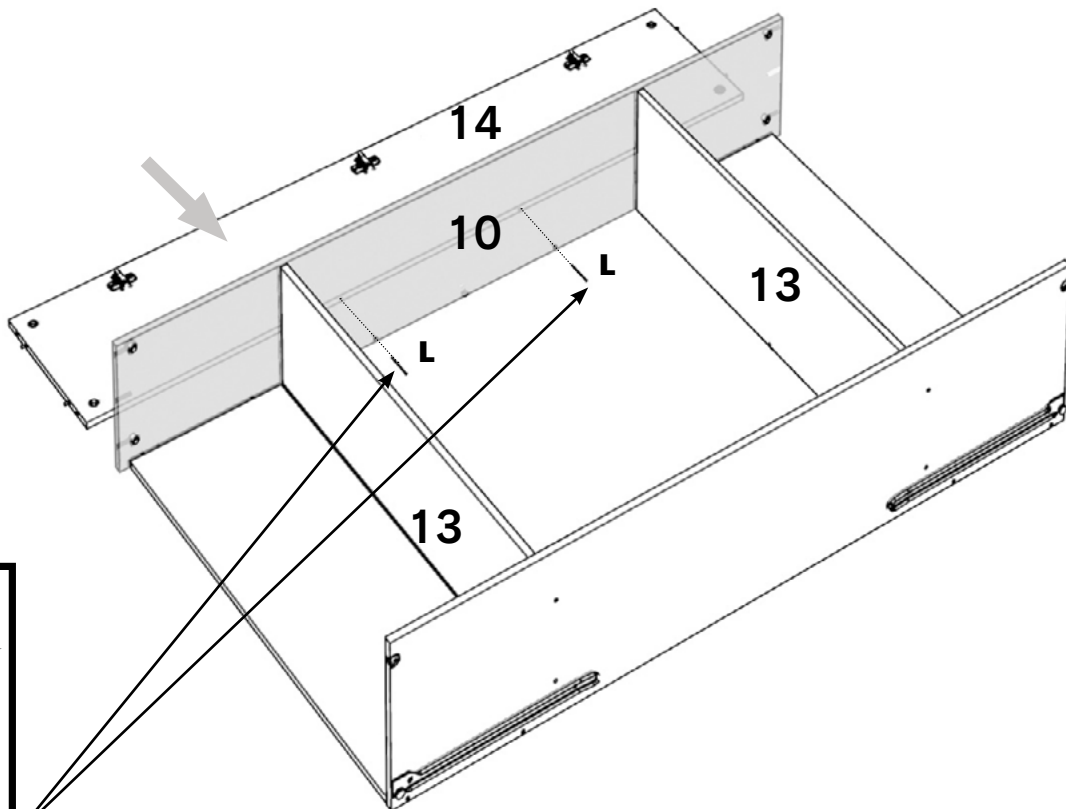

E+L

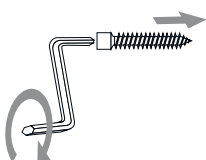

24

I x 02

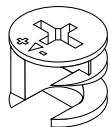

H x 04

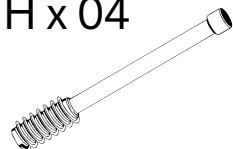

J x 04

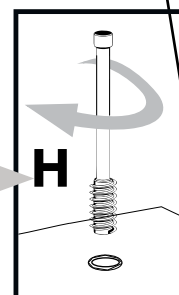
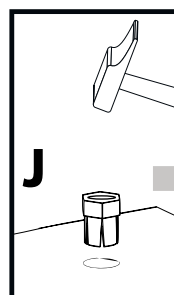
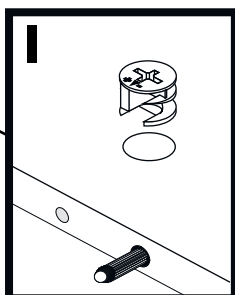
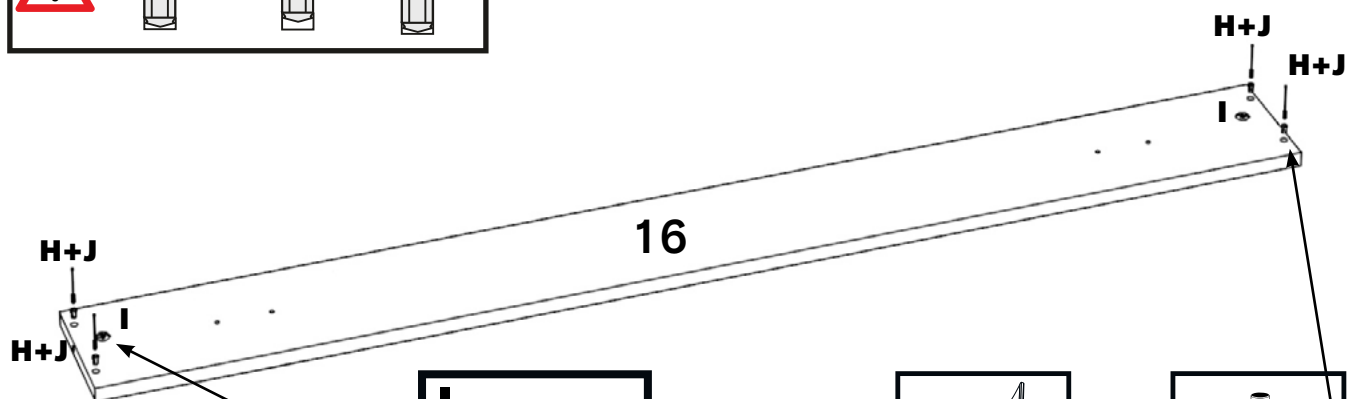
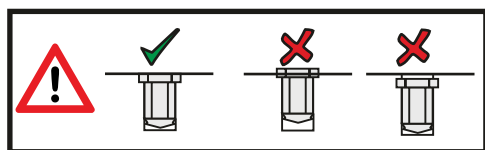
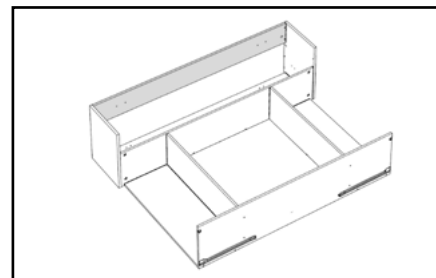

25

G x 05

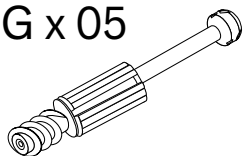

P x 02



T x 01

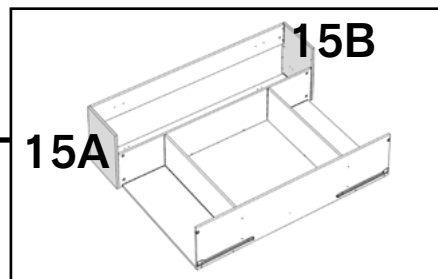
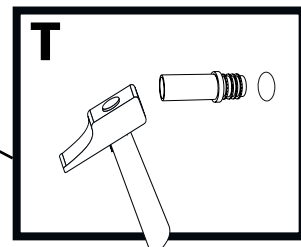
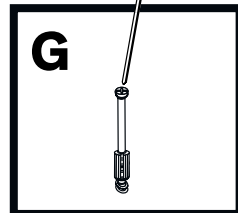
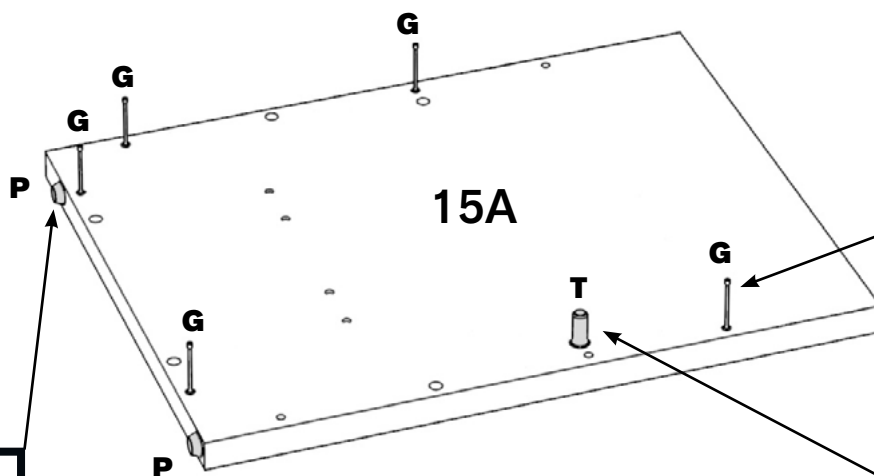
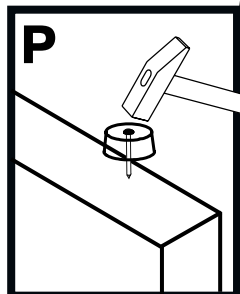
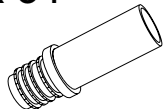

26

G x 05

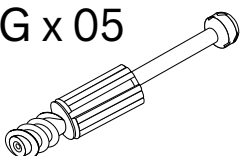

P x 02

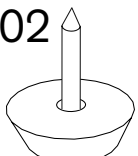

T x 01

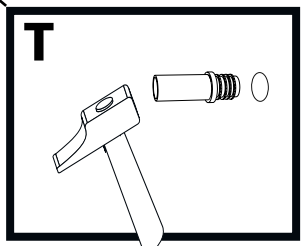
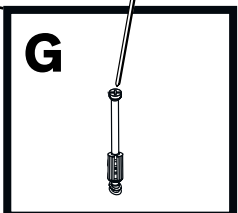
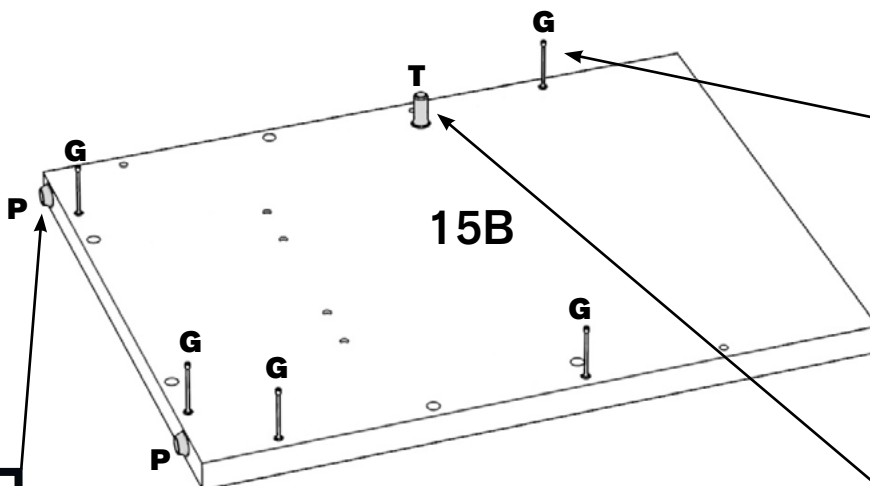
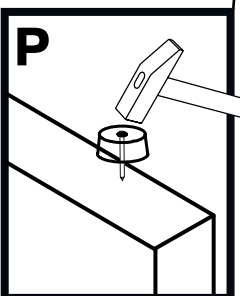
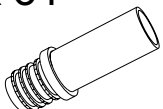

27

F x 01

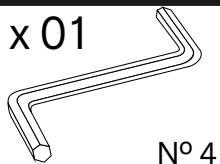

N° 4

Q x 08



17 mm.

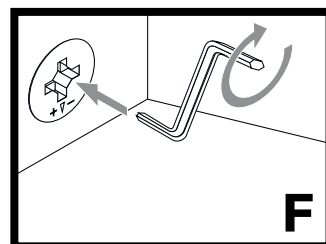

F

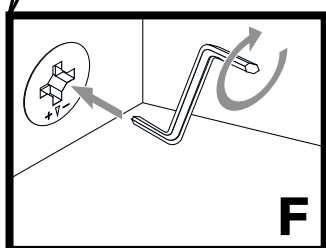
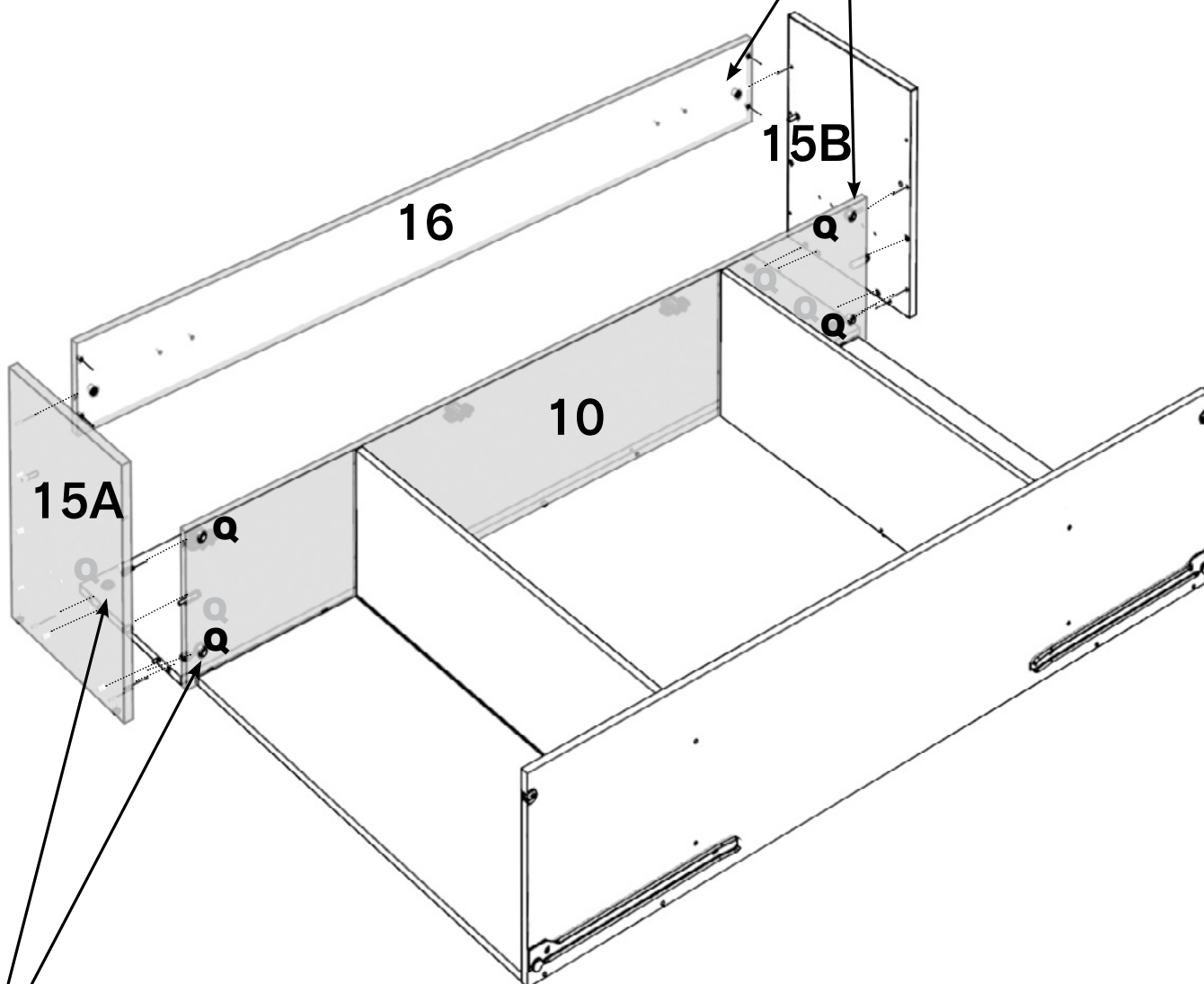

F

28

D x 04

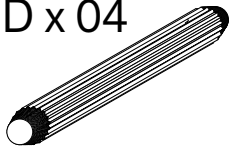

I x 08

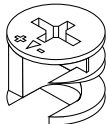

O x 02

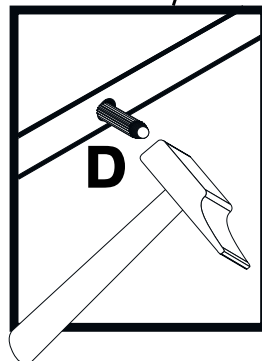
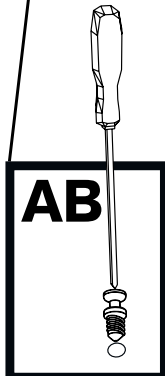
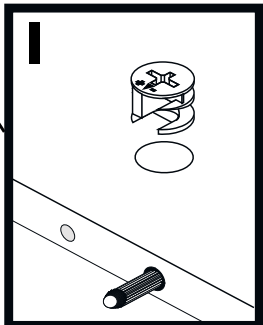
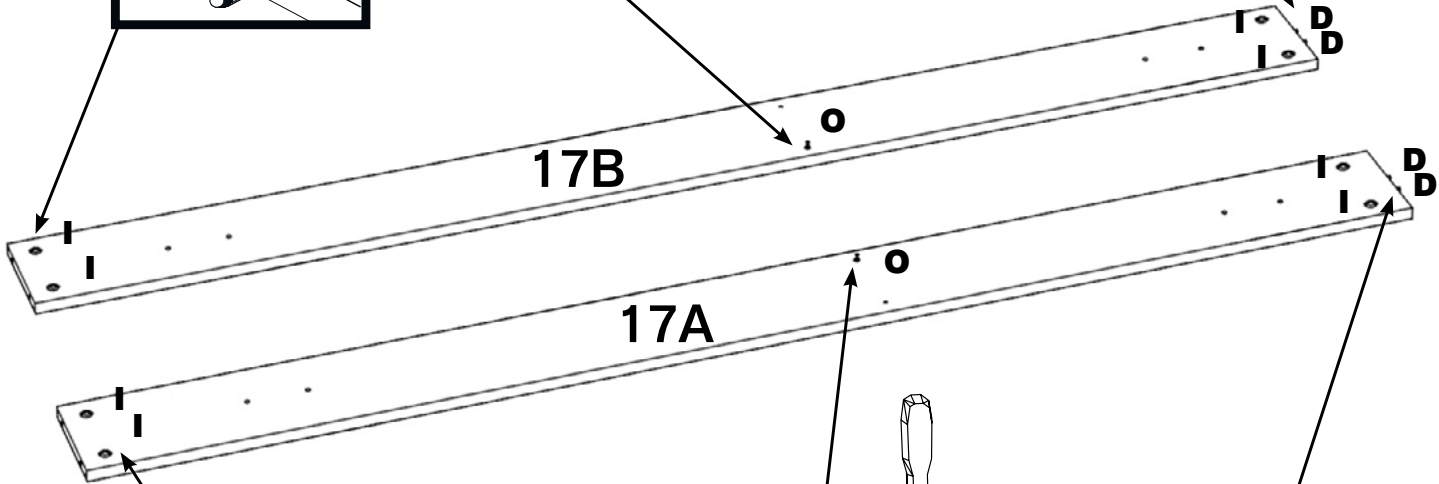
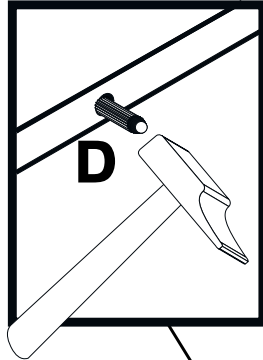
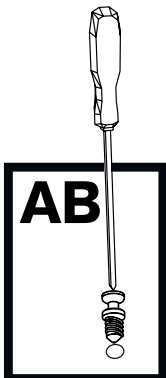
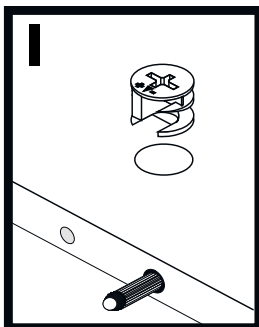

29

F x 01

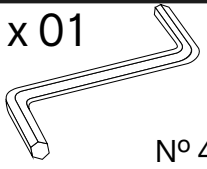

N° 4

Q x 06

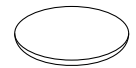

17 mm.

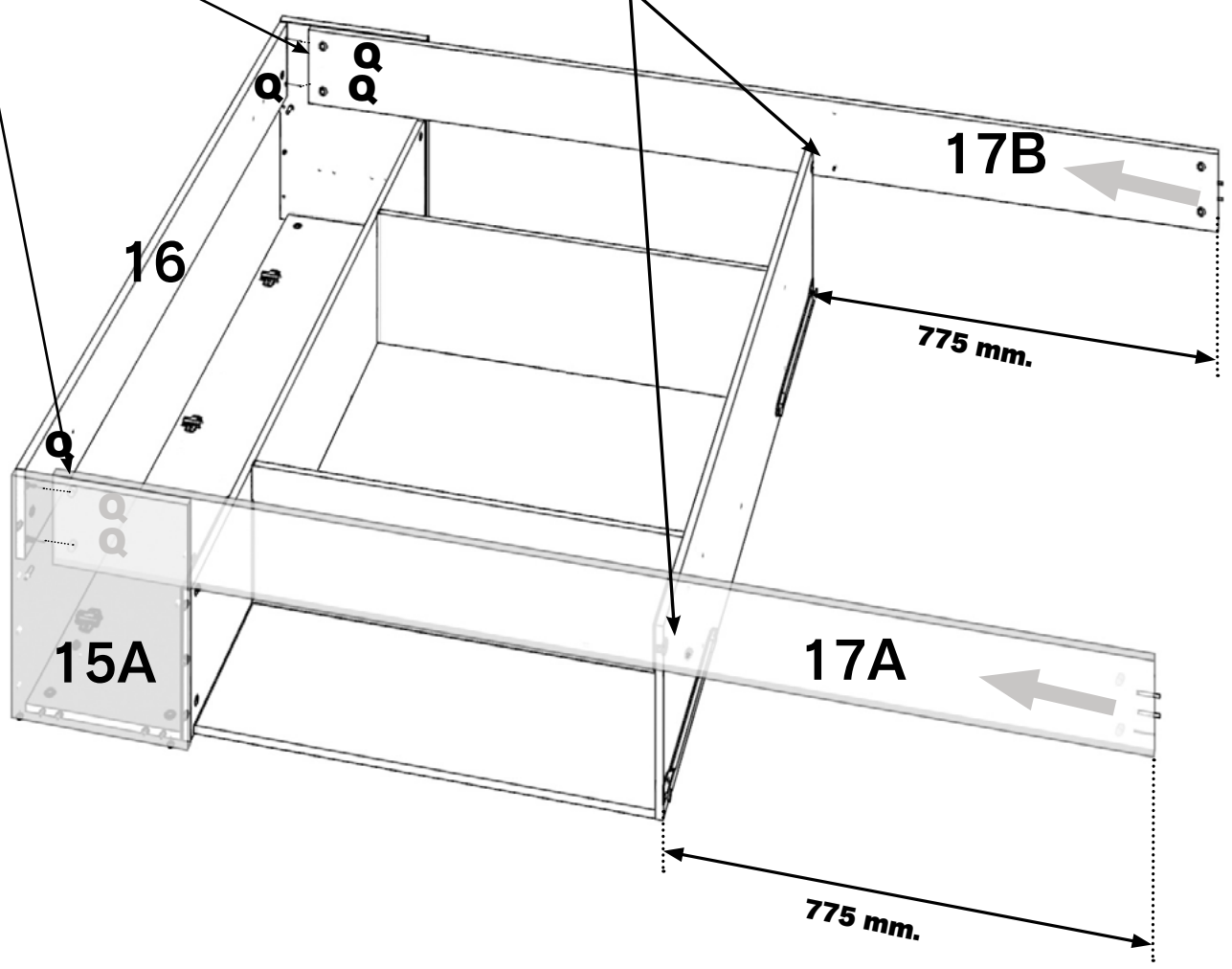
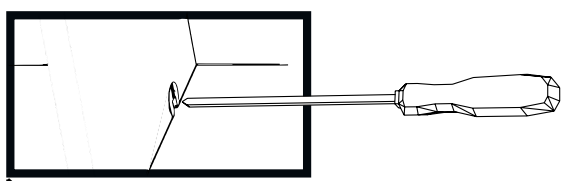
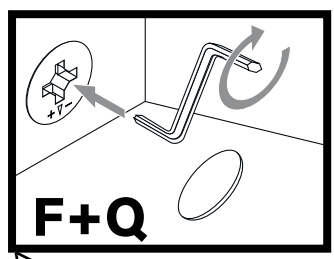

30

E x 01

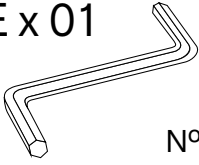

Nº 3

Q x 16

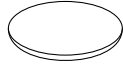

17 mm.

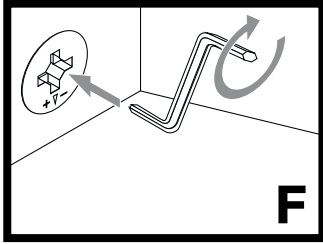

F

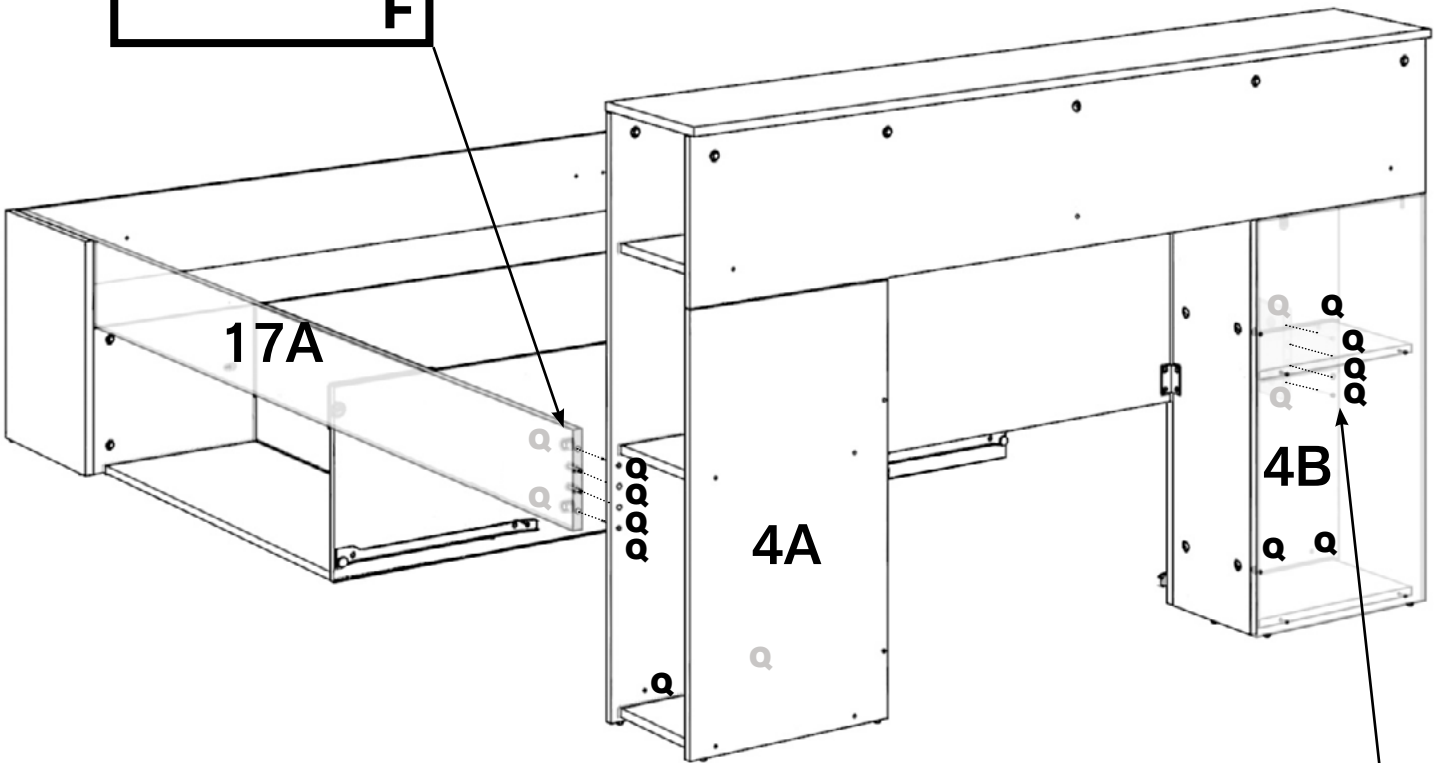

17A

4A

4B

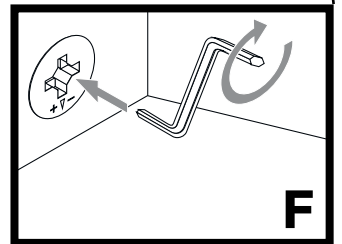

F

31

S x 04



M x 16

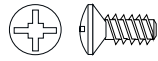

14 x 11 mm.

Q x 02



17 mm.

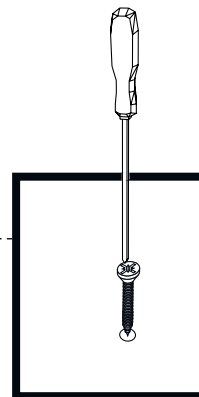
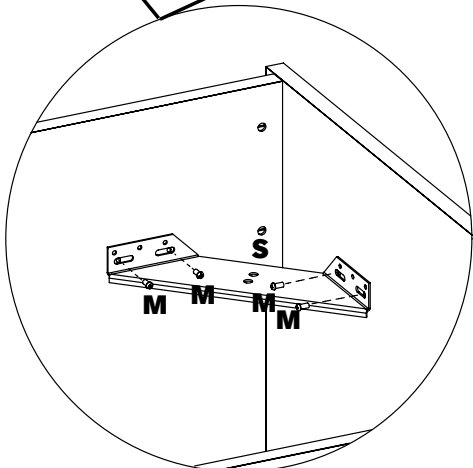
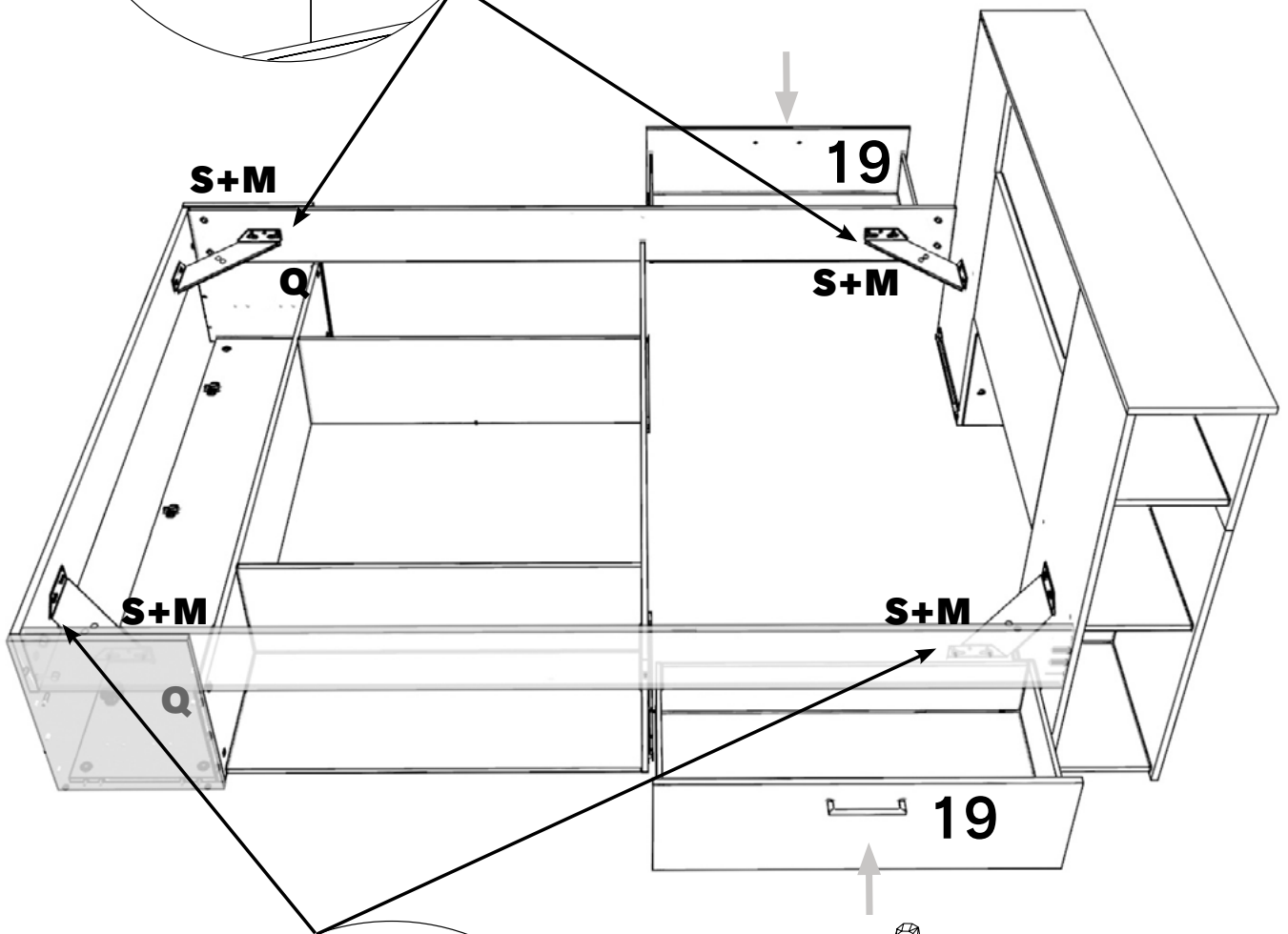
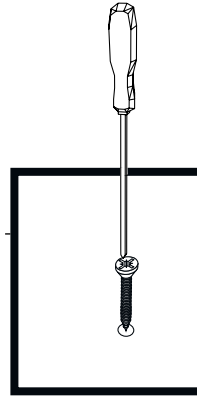
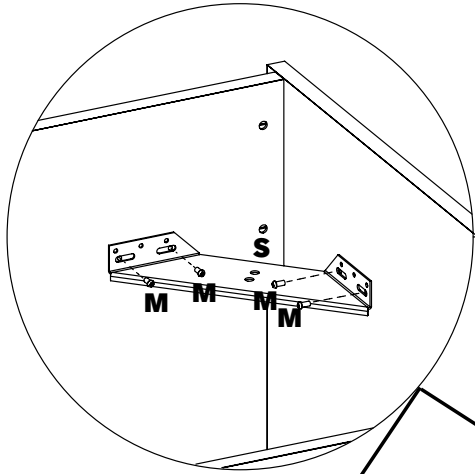

32

N x 08

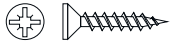

3.5 x 15 mm.

U x 02

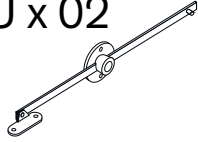

Q x 04



17 mm.

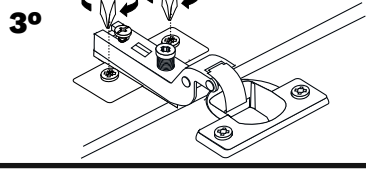
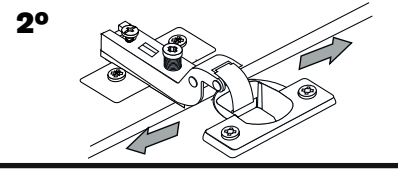
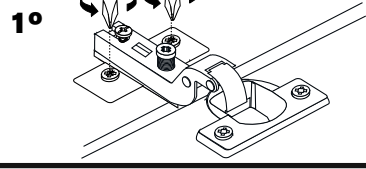
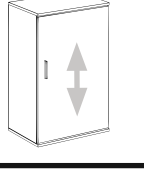
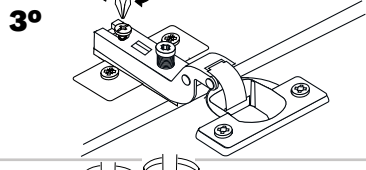
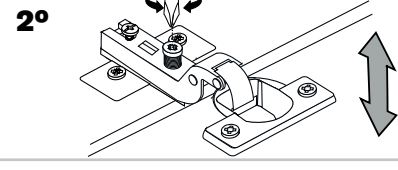
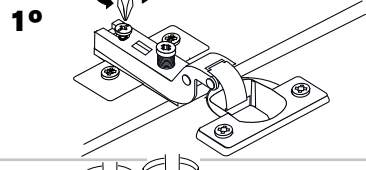
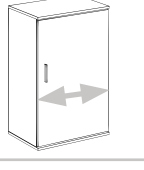
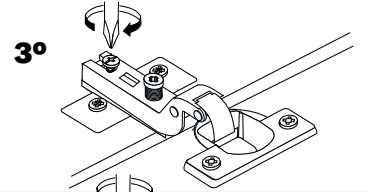
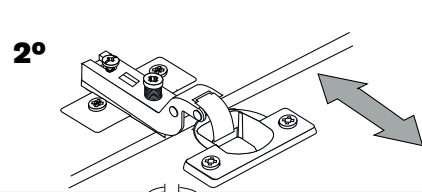
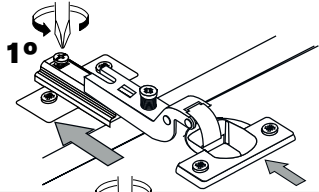
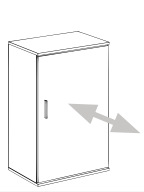
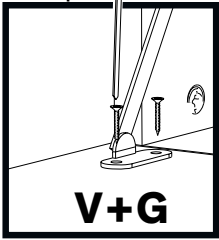
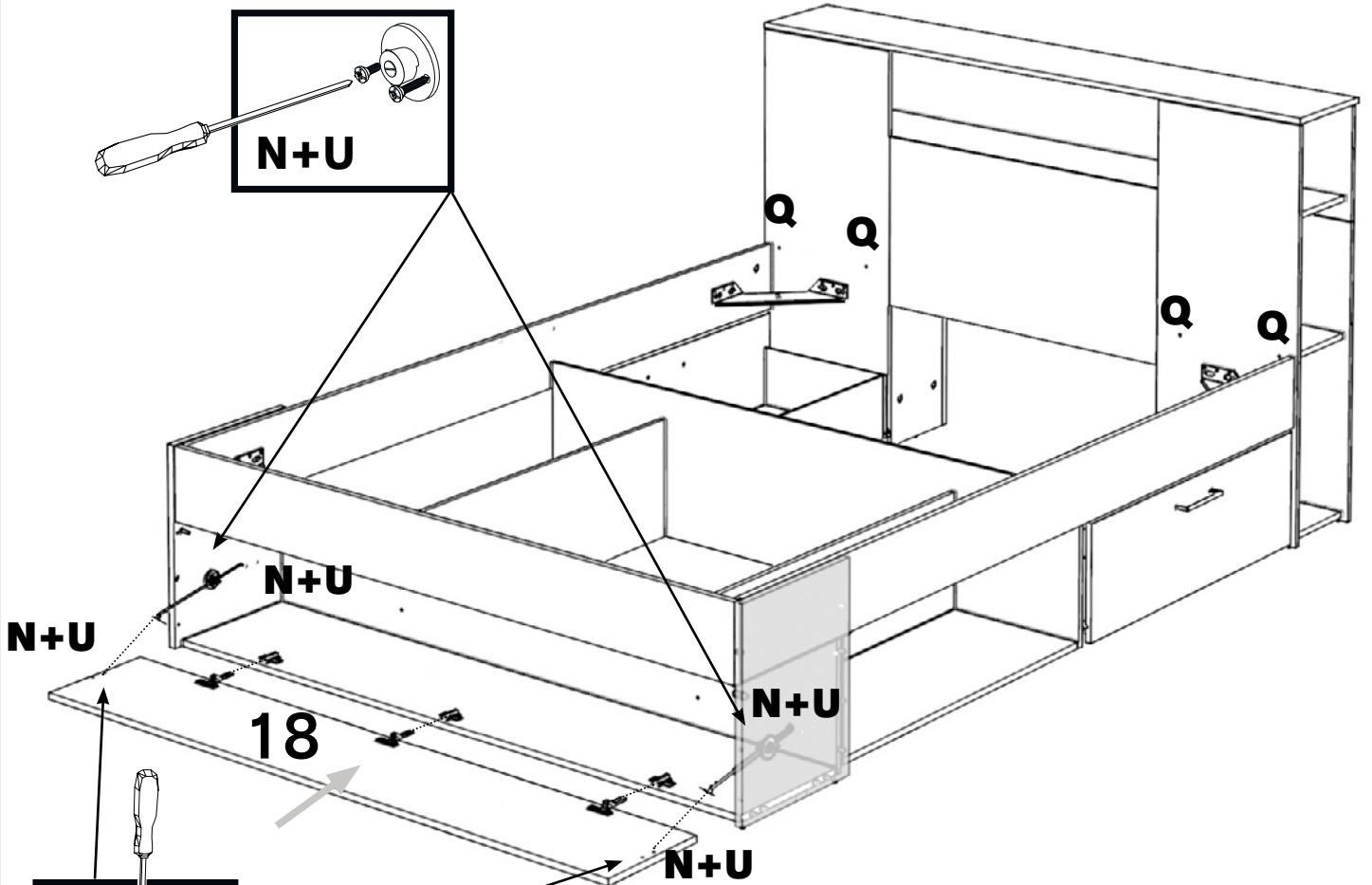

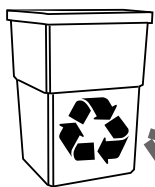

PLÁSTICO / PLASTIC
PLASTIQUE / PLÁSTICO
PLASTICA / PLASTIK
PLASTIKOWY

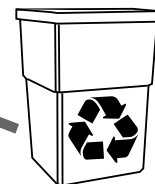
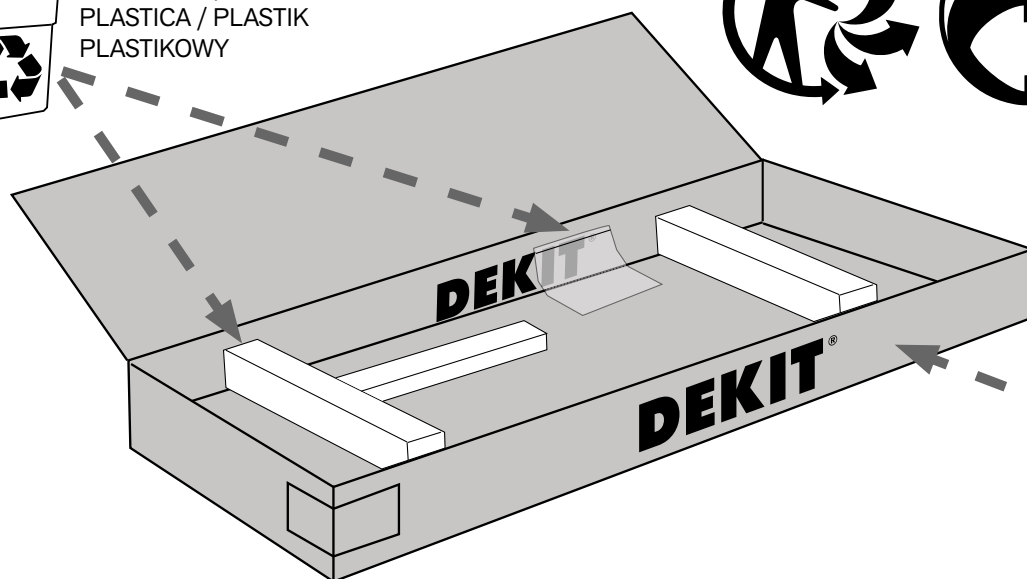
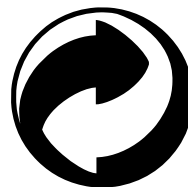

CARTÓN / CARDBOARD
CARTON / CARTÃO
CARTONE / KARTON



Adresses sur quefairedemesdechets.fr

GARANTÍA-WARRANTY-GARANTIE-GARANTIA-GARANZIA-GWARANCJA

ES

Distribuido por VENTE-UNIQUE.COM Dirección: 9 Rue Jacquart 93310 Le Pré-Saint-Gervais FRANCIA. Email: gpsr@vente-unique.com. Garantía de 3 años a partir fecha compra contra todo defecto de fabricación del producto. La garantía no incluye los defectos de mal montaje o mal uso del mueble.

Para cualquier defecto en el mueble o dificultades durante el montaje, por favor contacte con el establecimiento o sitio web donde compró el mueble.

Es necesario conservar el ticket de compra y el N° de Control de Calidad en caso de consulta o reclamación.

EN

Distributed by VENTE-UNIQUE.COM Address: 9 Rue Jacquart 93310 Le Pré-Saint-Gervais FRANCE. Email: gpsr@vente-unique.com. Guarantee of 3 years from the date of purchase against any manufacturing defect of the product. The guarantee does not include defects during the assembly or misuse of the furniture.

For any furniture defect of any difficulties during the assembly, please contact with the store or website where you purchased the furniture.

It is necessary to keep the purchase ticket and the Quality Control N° in case of any question or claim.

FR

Distribué par VENTE-UNIQUE.COM Adresse: 9 Rue Jacquart 93310 Le Pré-Saint-Gervais FRANCE. Email: gpsr@vente-unique.com. Garantie de 3 ans à compter de la date d'achat contre tout défaut de fabrication du produit. La garantie ne couvre pas les défauts dus à un mauvais montage ou à une mauvaise utilisation du meuble.

Pour tout défaut du meuble ou difficultés lors du montage, veuillez contacter le magasin ou la web où vous avez acheté le meuble.

Il est nécessaire de conserver la facture d'achat et le numéro de contrôle qualité en cas de demande d'information ou de réclamation.

PT

Distribuído por VENTE-UNIQUE.COM Endereço: 9 Rue Jacquart 93310 Le Pré-Saint-Gervais FRANÇA. Email: gpsr@vente-unique.com. Garantia de 3 anos a partir da data de compra contra qualquer defeito de fabricação do produto. A garantia não inclui defeitos decorrentes de má montagem ou mau uso do móvel.

Para qualquer defeito nos móveis ou dificuldades durante a montagem, entre em contato com a loja ou site onde comprou os móveis.

É necessário guardar o talão de compra e indicar o N° do Controle de Qualidade ao consultar ou reclamar.

IT

Distribuito da VENTE-UNIQUE.COM Indirizzo: 9 Rue Jacquart 93310 Le Pré-Saint-Gervais FRANCE. Email: gpsr@vente-unique.com. Garanzia 3 anni dalla data di acquisto contra qualsiasi difetto di fabbricazione del prodotto La garanzia non coprende i difetti dovuti al montaggio inadeguato o all'uso improprio dei mobili.

Per qualsiasi difetto del mobile o difficoltà durante il montaggio, si prega di contattare il negozio o il sito Web in cui è stato acquistato il mobile.

È necessario conservare il biglietto di acquisto e fornire il N° di Controllo Qualità in fase di consultazione o reclamo.

DE

Vertrieben von VENTE-UNIQUE.COM Indirizzo: 9 Rue Jacquart 93310 Le Pré-Saint-Gervais FRANCE. Email: gpsr@vente-unique.com. 3 Jahre Garantie ab Kaufdatum gegen Herstellungsfehler des Produkts. Die Garantie umfasst keine Mängel bei der Montage oder unsachgemäßer Verwendung der Möbel.

Bei Mängeln an den Möbeln oder Schwierigkeiten bei der Montage wenden Sie sich bitte an das Geschäft oder die Website, bei der Sie die Möbel gekauft haben.

Für den Fall von Fragen oder Reklamationen müssen Sie den Kaufbeleg und die Qualitätskontrollnummer aufbewahren.

NL

Gedistribueerd door VENTE-UNIQUE.COM Indirizzo: 9 Rue Jacquart 93310 Le Pré-Saint-Gervais FRANKRIJK. Email: gpsr@vente-unique.com. Garantie van 3 jaar vanaf de aankoopdatum tegen elk fabricagefout van het product. De garantie omvat geen defecten tijdens de montage of verkeerd gebruik van het meubilair. Voor elk meubeldefect of eventuele moeilijkheden tijdens de montage, neem contact op met de winkel of website.

Bewaar de aankoopbon en het nummer van de kwaliteitscontrole voor vragen of klachten.

PL

Dystrybucja VENTE-UNIQUE.COM Indirizzo: 9 Rue Jacquart 93310 Le Pré-Saint-Gervais FRANCE. Email: gpsr@vente-unique.com. Gwarancja 3 lata od daty zakupu na wszelkie wady produkcyjne produktu. Gwarancja nie obejmuje wad powstałych podczas montażu lub niewłaściwego użytkowania mebli.

W przypadku jakichkolwiek wad mebli lub trudności podczas montażu prosimy o kontakt ze sklepem lub stroną internetową.

Konieczne jest zachowanie dowodu zakupu i numeru kontroli jakości na wypadek pytań lub reklamacji.

N° Control Calidad:

Quality Control N°:

N° Contrôle Qualité:

N° Controle Qualidade:

Controllo Qualità:

Qualitätskontrolle Nummer:

Kwaliteitscontrole Nummer:

N° kontroli jakości: