

MONTAGEANLEITUNG//ASSEMBLY INSTRUCTION

Artikelnummer/ItemNumber: N634P461194W
N634P461195W

Unser Bett wird in 2 Paketen geliefert. Die Lieferzeit dieser 2 Pakete können abweichen. bitte haben Sie etwas Geduld und vielen Dank für Ihr Verständnis.

Our bed will be sent to you in two packages. The delivery time of these two parcels may be different. Please be patient. Thank you for your understanding.

Bett 200x90cm

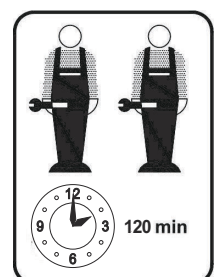
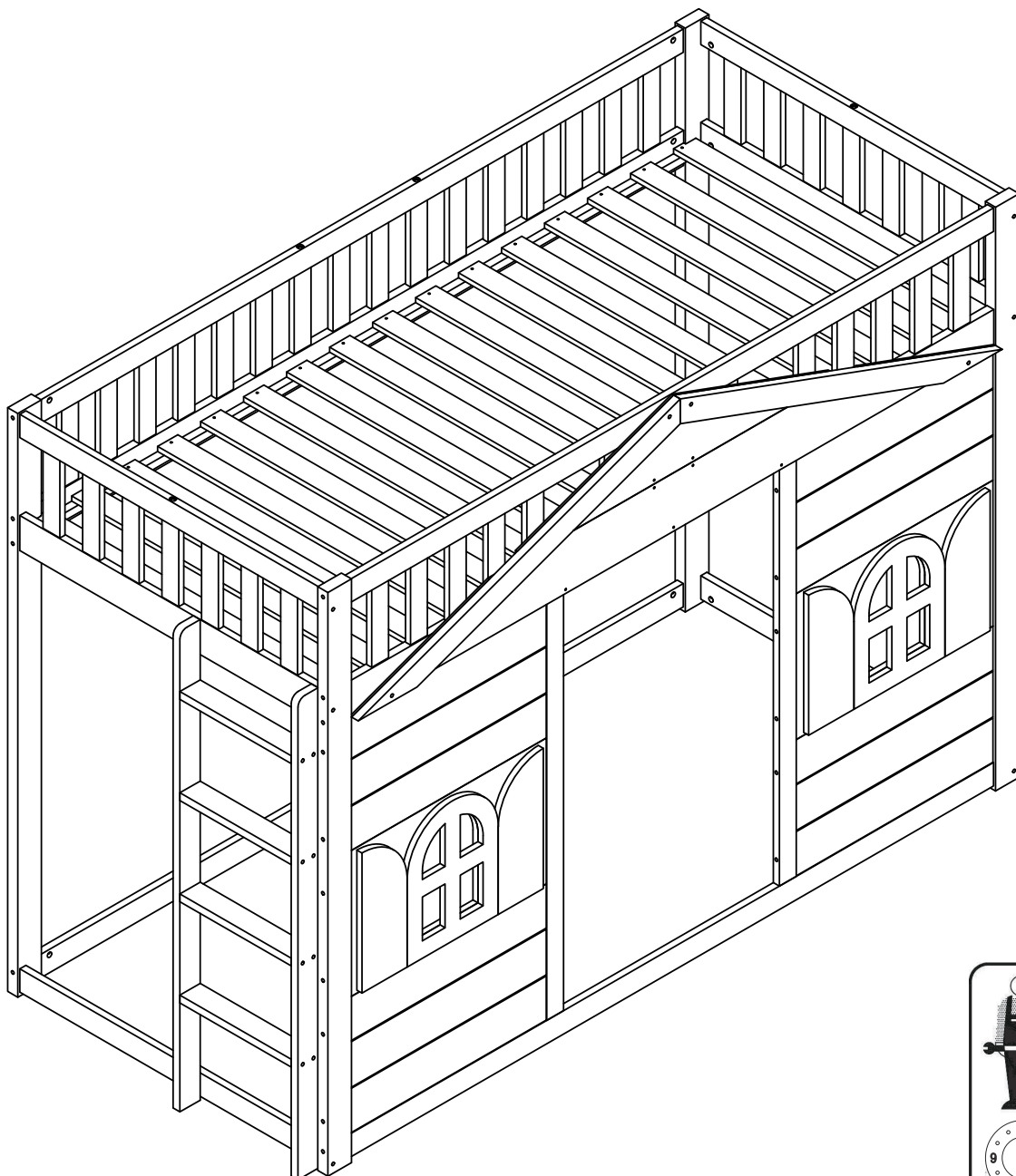

FR - Notice de montage / EN - Assembly instructions / PT - Instruções de montagem / ES - Prospecto de montaje / DE - Montageanleitung / IT - Istruzioni di montaggio / NL - Montagehandleiding

FR - IMPORTANT! CONSERVER POUR CONSULTATION ULTERIEURE: LIRE ATTENTIVEMENT

- A monter par un adulte. Un adulte doit vérifier le bon assemblage avant l'emploi
- ATTENTION! tenir les vis et petits éléments et sachets hors de portée des enfants
- Bien identifier les éléments avant de commencer le montage
- Ne pas utiliser votre article lorsque l'un de ses éléments est cassé ou manquant
- En cas de problème contactez notre service après-vente
- Toujours suivre les instructions du fabricant
- Entretien: nettoyer avec un chiffon doux et sec. En cas de taches plus grosses, frottez soigneusement avec une éponge légèrement humide et non abrasive
- Ne pas sauter sur le lit

EN - IMPORTANT! KEEP FOR FUTURE REFERENCE: READ CAREFULLY

- To be assembled by an adult. Assembly must be checked by an adult before use
- WARNING! keep all screws, small parts and plastic bags out of the reach of children
- Properly identify all parts before assembling
- Never use your item if any of its parts are broken or missing
- Should any problems arise, please contact our After Sales Service
- Manufacturer's instructions shall be followed at all times
- Care: clean with a soft, dry cloth. In case of larger stains, carefully rub with a slightly damp, non-abrasive sponge
- Do not jump on the bed

PT - IMPORTANTE! GARDE PARA CONSULTA POSTERIOR: LER ESTAS INSTRUÇÕES CUIDADOSAMENTE

- A ser montado por um adulto. Um adulto deve verificar a boa montagem antes da utilização
- Atenção! mantenha os parafusos, acessórios pequenos e saco de plástico fora do alcance das crianças
- Identifique bem os acessórios antes de começar a montagem
- Não utilizar o artigo se um dos elementos está em falta ou danificado
- Para qualquer esclarecimento, contacte os nossos serviços através do telefone
- As instruções do fabricante devem ser sempre cumpridas
- Manutenção: limpe com um pano macio e seco. Em caso de manchas maiores, esfregue cuidadosamente com uma esponja ligeiramente húmida e não abrasiva
- Não salte na cama

ES - IMPORTANTE! CONSERVAR PARA FUTURAS CONSULTAS: LEER DETENIDAMENTE

- A montar por un adulto. Un adulto debe comprobar el buen montaje antes de la utilización
- ¡ADVERTENCIA! mantener los tornillos, los pequeños elementos y bolsitas fuera del alcance de los niños
- Identificar debidamente los elementos antes de empezar el montaje
- No utilizar este artículo si uno de los elementos falta o esta roto
- Si tiene problemas, contactar nuestro servicio postventa
- Deben seguirse siempre las instrucciones del fabricante Cuidados: limpiar con un paño suave y seco. En caso de manchas grandes, frotar con cuidado utilizando una esponja húmeda no abrasiva
- No saltar sobre la cama

DE - WICHTIG! FÜR SPÄTERE BEZUGNAHME AUFBEWAHREN: SORGFÄLTIG LESEN

- Von einem Erwachsenen zu montieren. Die korrekte Montage muss vor Gebrauch von einem Erwachsenen geprüft werden
- Achtung! die Schrauben und kleinen Teile ausserhalb der Reichweite von Kindern lagern
- Vor Montagebeginn alle Teile identifizieren
- Ihren Artikel nicht benutzen, wenn eines seiner Bestandteile beschädigt ist oder fehlt
- Im Problemfall Ihren Kundendienst anrufen
- Stets die Herstelleranweisungen beachten
- Wartung: Mit einem weichen, trockenen Tuch reinigen. Bei größeren Flecken vorsichtig mit einem leicht feuchten, nicht scheuernden Schwamm abreiben
- Nicht auf dem Bett springen

IT - IMPORTANTE! CONSERVARE QUESTE INFORMAZIONI PER ULTERIORI CONSULTAZIONI: LEGGI ATTENTAMENTE

- Il montaggio deve essere eseguito da un adulto. Un adulto dovrà verificare il corretto montaggio prima dell'uso
- ATTENZIONE! tenere le viti ed i componenti di piccole dimensioni lontano dalla portata dei bambini
- Controllare i pezzi prima del montaggio
- L'articolo non deve essere utilizzato in caso di elementi mancanti o danneggiati
- In caso di necessità contattare il nostro servizio post-vendita
- Seguire sempre le istruzioni del costruttore
- Manutenzione: pulire con un panno morbido e asciutto. Per le macchine più grandi, strofinare accuratamente con una spugna leggermente umida e non abrasiva
- Non saltare sul letto

NL - BELANGRIJK! BEWAAR VOOR LATERE RAADPLEGING: LEES AANDACHTIG

- Moet door een volwassene worden gemonteerd. Voor gebruik moet een volwassene controleren dat het product goed in elkaar is gezet
- WAARSCHUWING! schroeven en kleine elementen en zakjes buiten bereik van kinderen houden
- De elementen goed identificeren alvorens met de montage te beginnen
- Uw artikel niet gebruiken wanneer een van de onderdelen kapot is of ontbreekt
- Neem bij problemen contact op met onze klantenservice
- Volg altijd de instructies van de fabrikant
- Onderhoud: maak schoon met een zachte en droge doek. In geval van grotere vlekken, veeg voorzichtig schoon met een licht bevochtigde en niet-schurende spons
- Niet springen op het bed

English

IMPORTANT ! KEEP FOR FUTURE REFERENCE : READ CAREFULLY

- To be assembled by an adult. Assembly must be checked by an adult before use
- WARNING ! Keep all screws, small parts and plastic bags out of the reach of children
- Properly identify all parts before assembling
- Never use your item if any of its parts are broken or missing
- Should any problems arise, please contact our After Sales Service
- Manufacturer's instructions shall be followed at all times
- Care: Clean with a soft, dry cloth. In case of larger stains, carefully rub with a slightly damp, non-abrasive sponge
- Avoid the risk of fire by not placing furniture near sources of ignition or hot items
- Do not jump on the bed

Deutsch

WICHTIG ! ZUM SPÄTEREN NACHSCHLAGEN AUFBEWAHREN: SORGFÄLTIG LESEN

- Muss von einem Erwachsenen zusammengebaut werden. Der Zusammenbau muss vor dem Gebrauch von einem Erwachsenen überprüft werden
- WARNUNG! Bewahren Sie alle Schrauben, Kleinteile und Plastikbeutel außerhalb der Reichweite von Kindern auf
- Kennzeichnen Sie vor dem Zusammenbau alle Teile richtig
- Benutzen Sie Ihren Artikel niemals, wenn Teile gebrochen sind oder fehlen
- Sollten Probleme auftreten, wenden Sie sich bitte an unseren Kundendienst
- Die Anweisungen des Herstellers sind stets zu befolgen
- Pflege: Mit einem weichen, trockenen Tuch reinigen. Bei größeren Flecken vorsichtig mit einem leicht feuchten, nicht scheuernden Schwamm abreiben. nicht scheuernden Schwamm
- Vermeiden Sie die Gefahr eines Brandes, indem Sie die Möbel nicht in der Nähe von Zündquellen oder heißen Gegenständen aufstellen
- Nicht auf das Bett springen

Français

IMPORTANT ! CONSERVER POUR RÉFÉRENCE ULTÉRIEURE : LIRE ATTENTIVEMENT

- Le montage doit être effectué par un adulte. Le montage doit être vérifié par un adulte avant Utilisation
- ATTENTION ! Tenir les vis, les petites pièces et les sachets en plastique hors de portée des enfants
- Identifiez correctement toutes les pièces avant de les assembler
- N'utilisez jamais votre article si l'une de ses pièces est cassée ou manquante
- En cas de problème, veuillez contacter notre service après-vente
- Les instructions du fabricant doivent être respectées à tout moment
- Entretien : nettoyer avec un chiffon doux et sec. En cas de taches plus importantes, frotter soigneusement avec une éponge non abrasive légèrement humide. légèrement humide et non Abrasive
- Évitez les risques d'incendie en ne plaçant pas les meubles à proximité de sources d'inflammation ou d'objets chauds
- Ne pas sauter sur le lit

Italiano

IMPORTANTE! CONSERVARE PER RIFERIMENTO FUTURO: LEGGERE ATTENTAMENTE

- Deve essere assemblato da un adulto. L'assemblaggio deve essere controllato da un adulto prima dell'uso
- **ATTENZIONE!** Tenere tutte le viti, le piccole parti e i sacchetti di plastica fuori dalla portata dei bambini
- Identificare correttamente tutte le parti prima dell'assemblaggio
- Non utilizzare mai l'articolo se alcune parti sono rotte o mancanti
- In caso di problemi, si prega di contattare il nostro Servizio Post Vendita
- Le istruzioni del produttore devono essere sempre seguite
- Cura: Pulire con un panno morbido e asciutto. In caso di macchie più estese, strofinare accuratamente con una spugna leggermente umida e nonspugna leggermente umida e non abrasiva
- Evitare il rischio di incendio, non collocando i mobili vicino a fonti di accensione o a oggetti caldi
- Non saltare sul letto

Español

¡ IMPORTANTE ! CONSERVELO PARA FUTURAS CONSULTAS: LEA ATENTAMENTE

- Debe ser montado por un adulto. El montaje debe ser comprobado por un adulto antes del uso
- ADVERTENCIA Mantenga todos los tornillos, piezas pequeñas y bolsas de plástico fuera del alcance de los niños.
- Identifique correctamente todas las piezas antes de montarlas
 - Nunca utilice su artículo si alguna de sus piezas está rota o falta
 - Si surge algún problema, póngase en contacto con nuestro Servicio Postventa
 - Las instrucciones del fabricante deben seguirse en todo momento
 - Cuidado: Limpiar con un paño suave y seco. En caso de manchas más grandes, frote cuidadosamente con una esponja no abrasiva ligeramente humedecida.
 - Evite el riesgo de incendio no colocando los muebles cerca de fuentes de ignición u objetos calientes.
 - No saltar sobre la cama.

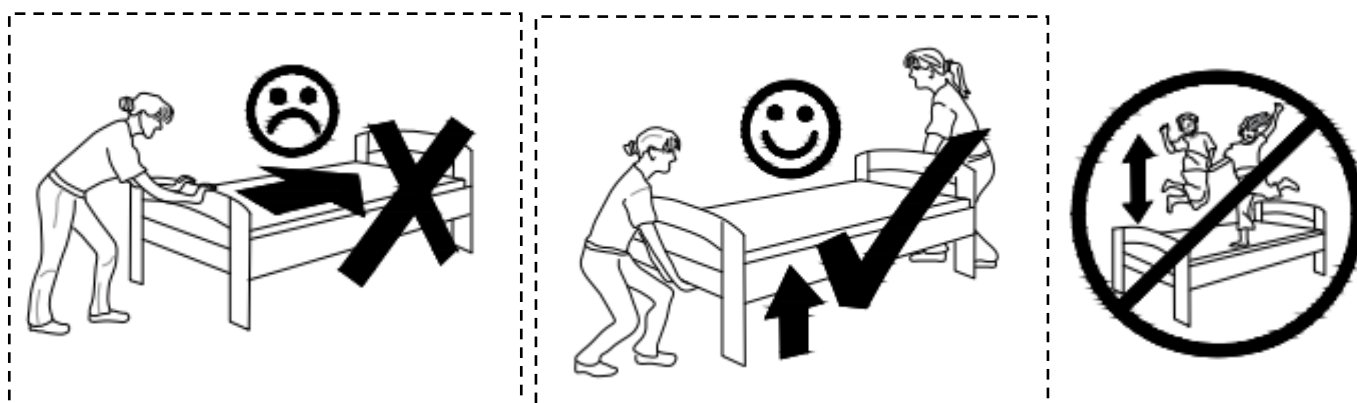

INSTRUCTIONS

IMPORTANT-READ CAREFULLY-RETAIN FOR FUTURE REFERENCE

- a) **WARNING** -Children can become trapped between the bed and the wall, the adjoining pieces of furniture (e.g. cupboards) and the like. To avoid risk of serious injury the distance between the safety barrier and the adjoining structure shall not exceed 90 mm or shall be more than 230 mm.
- b) **WARNING**-Do not use the bed if any structural part is broken or missing; Replacement parts are between requested from the manufacturer or the store.
- c) **WARNING**-Do not climb or wiggle on any non-designated structures.
- d) it is imperative to always follow the installation instructions and manufacturer's use.
- e) **The recommended size of the mattress to be used with the bed is 200cmx90cm, maximum thickness mattress:13cm.**
- f) It is necessary to ventilate the room in order to maintain a low level moisture and prevent mold growth in the bed and its periphery.
- g) Joining devices should always be tightened properly and regularly verified. Tighten if necessary.

ANLEITUNGEN

WICHTIG - SORGFÄLTIG LESEN - FÜR SPÄTERE VERWENDUNG

AUFBEWAHREN

- a) **WARNUNG** - Kinder können zwischen dem Bett und der Wand, den angrenzenden Möbelstücken (z. B. Schränken) und der Lücke eingeklemmt werden. Um die Gefahr schwerer Verletzungen zu vermeiden, darf der Abstand zwischen der Sicherheitsbarriere und der angrenzenden Struktur nicht mehr als 90 mm oder mehr als 230 mm betragen.
- b) **WARNUNG**-Das Bett darf nicht benutzt werden, wenn ein Bauteil gebrochen ist oder fehlt; Ersatzteile sind beim Hersteller oder im Geschäft anzufordern.
- c) **WARNUNG** - Klettern oder wackeln Sie nicht auf nicht dafür vorgesehenen Strukturen.
- d) Befolgen Sie unbedingt die Installationsanweisungen und die Gebrauchsanweisungen des Herstellers.
- e) **Die empfohlene Größe der Matratze für das Bett beträgt 200x90cm, maximale Dicke der Matratze: 13cm.**
- f) Es ist notwendig, den Raum zu lüften, um die Feuchtigkeit niedrig zu halten und Schimmelbildung im Bett und seiner Umgebung zu verhindern.
- g) Die Verbindungselemente sollten immer richtig angezogen sein und regelmäßig überprüft werden. Ziehen Sie sie gegebenenfalls nach.

ASSEMBLY INSTRUCTIONS

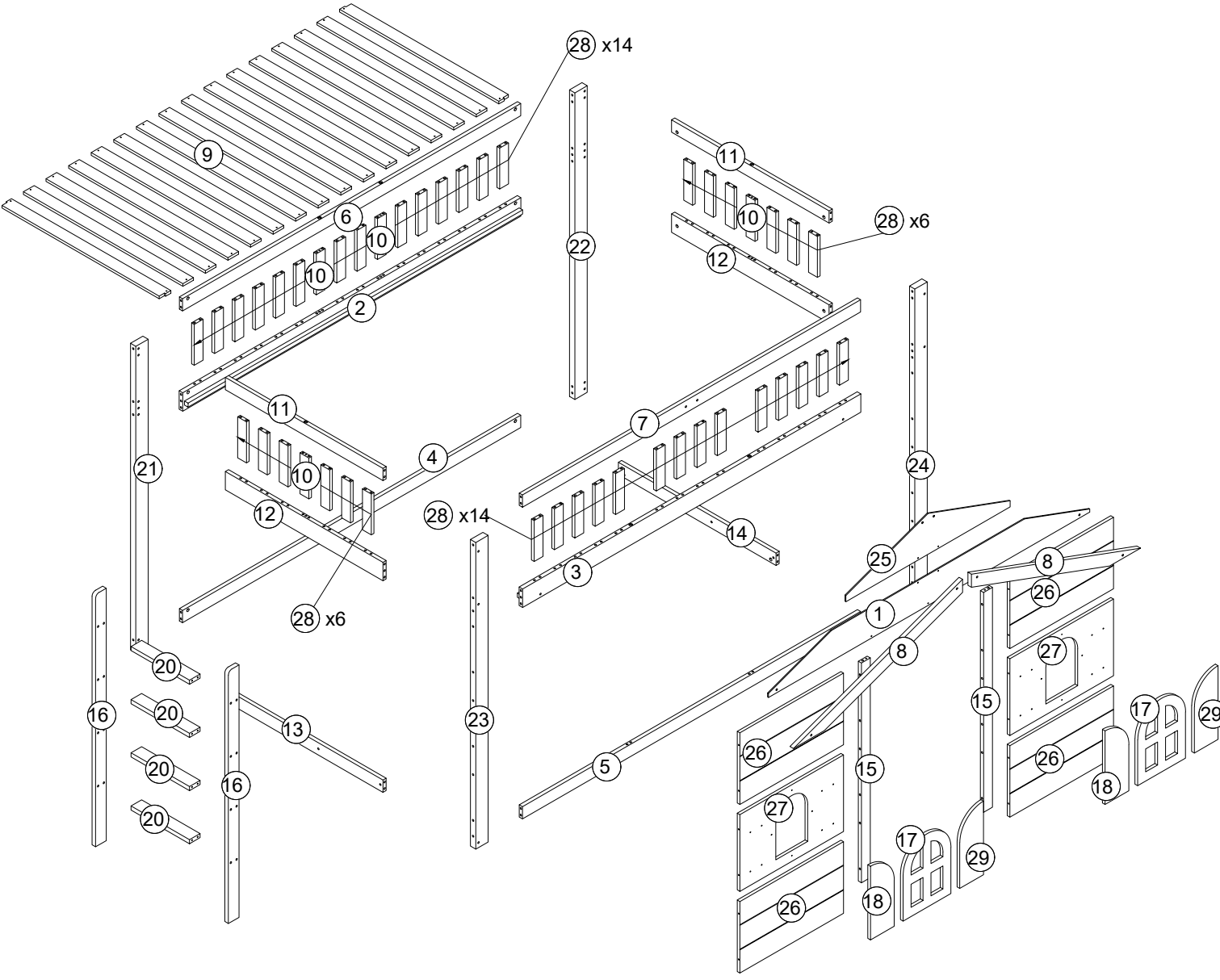

Etagenbett

Part List : N634P461194W

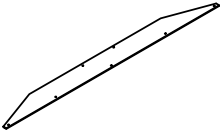
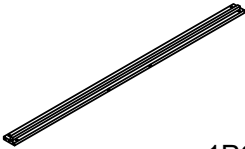
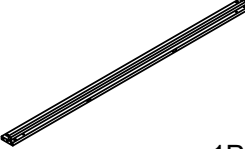
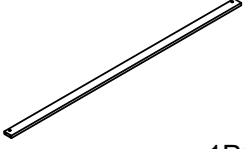
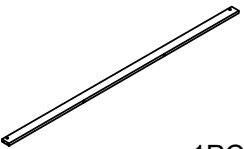
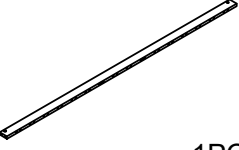
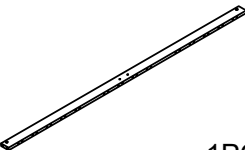
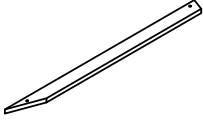
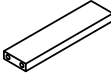
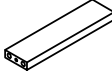
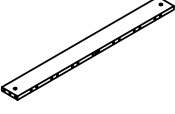
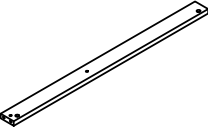
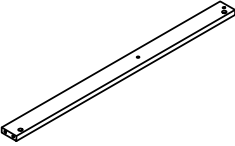
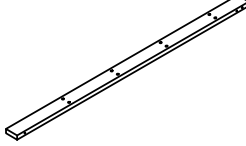
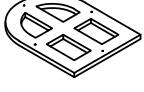
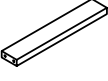
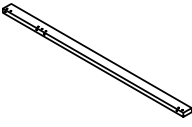
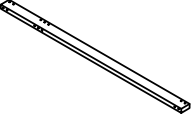
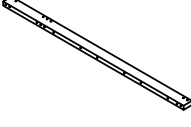
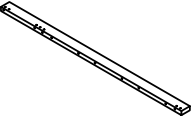



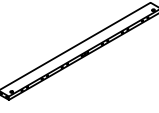
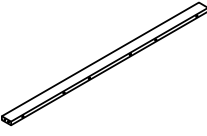
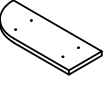
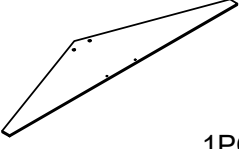
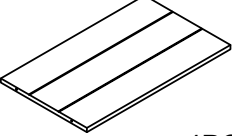
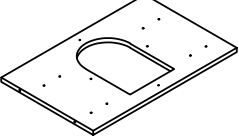
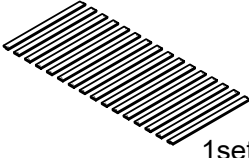
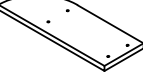



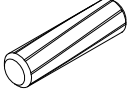

1  1PC	2  1PC	3  1PC	4  1PC	5  1PC
6  1PC	7  1PC	8  2PCS	28  40PCS	10  4PCS
12  2PCS	13  1PC	14  1PC	16  2PCS	17  2PCS
20  4PCS	21  1PC	22  1PC	23  1PC	24  1PC

Part List : N634P461195W

11  2PCS	15  2PCS	18  2PCS	25  1PC	26  4PCS
27  2PCS	9  1set	29  2PCS		

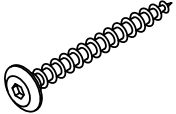
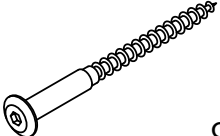
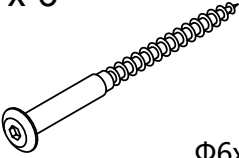
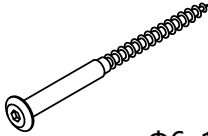
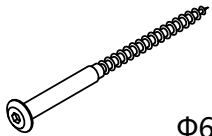
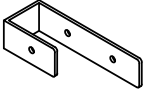
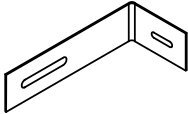
Hardware

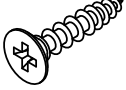
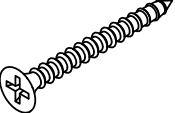
Part List : N634P461195W

<p>A x 12</p>  <p>M6x70</p>	<p>B x 16</p>  <p>M6x110</p>	<p>C x 28</p>  <p>Φ10x12</p>	<p>D x 208</p>  <p>Φ8x30</p>
<p>E x 24</p>  <p>Φ4x25</p>	<p>F x 4</p>  <p>M6x30</p>	<p>G x 4</p>  <p>M6x20</p>	<p>H x 18</p>  <p>Φ6x50</p>
<p>J x 12</p>  <p>Φ6x80</p>	<p>K x 6</p>  <p>Φ6x90</p>	<p>M x 12</p>  <p>Φ6x100</p>	<p>N x 6</p>  <p>Φ6x110</p>
<p>P x 2</p> 	<p>Q x 2</p> 	<p>R x 2</p>  <p>R1 R2</p>	<p>T x 2</p>  <p>Φ4x15</p>
<p>U x 38</p>  <p>Φ4x30</p>	<p>V x 2</p> 	<p>W x 7</p>  <p>Φ4x15</p>	

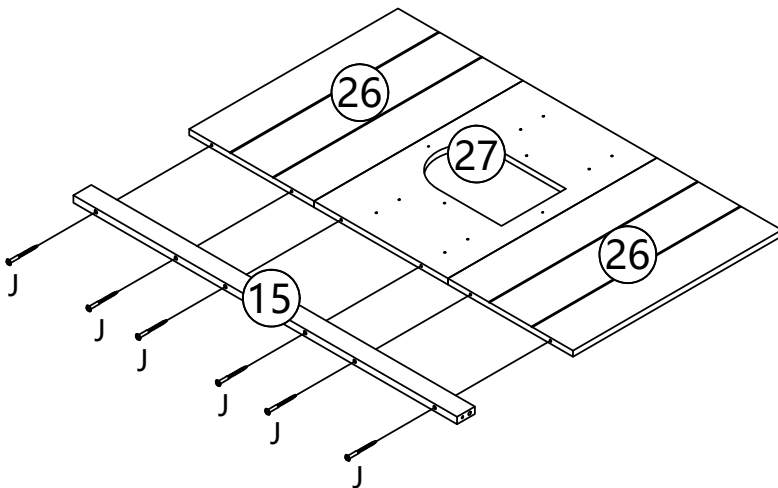
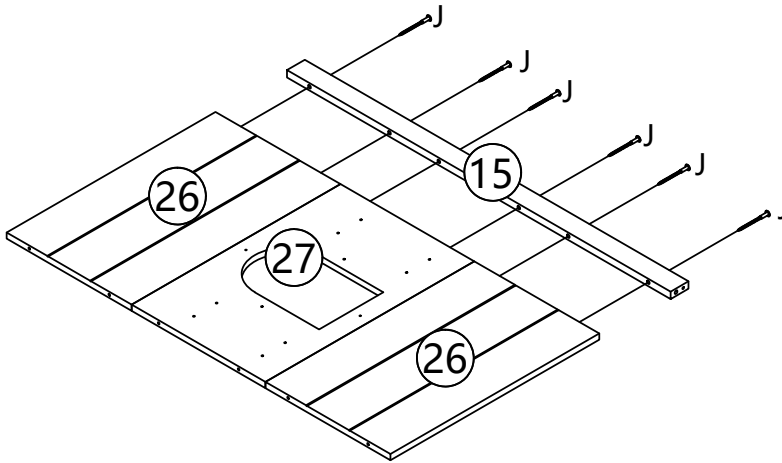
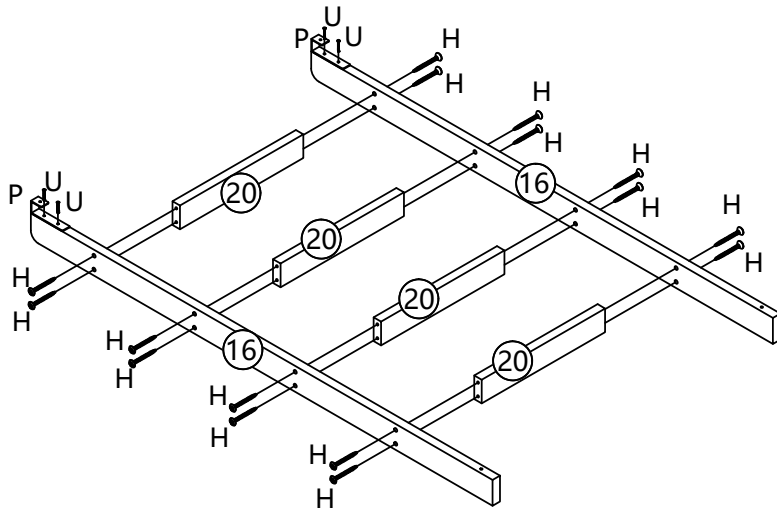

STEP:1

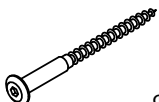
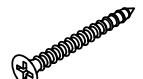
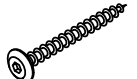

<p>P x 2</p> 	<p>J x 12</p>  <p>Φ6x80</p>	<p>U x 4</p>  <p>Φ4x30</p>	<p>H x 16</p>  <p>Φ6x50</p>
--	--	---	--

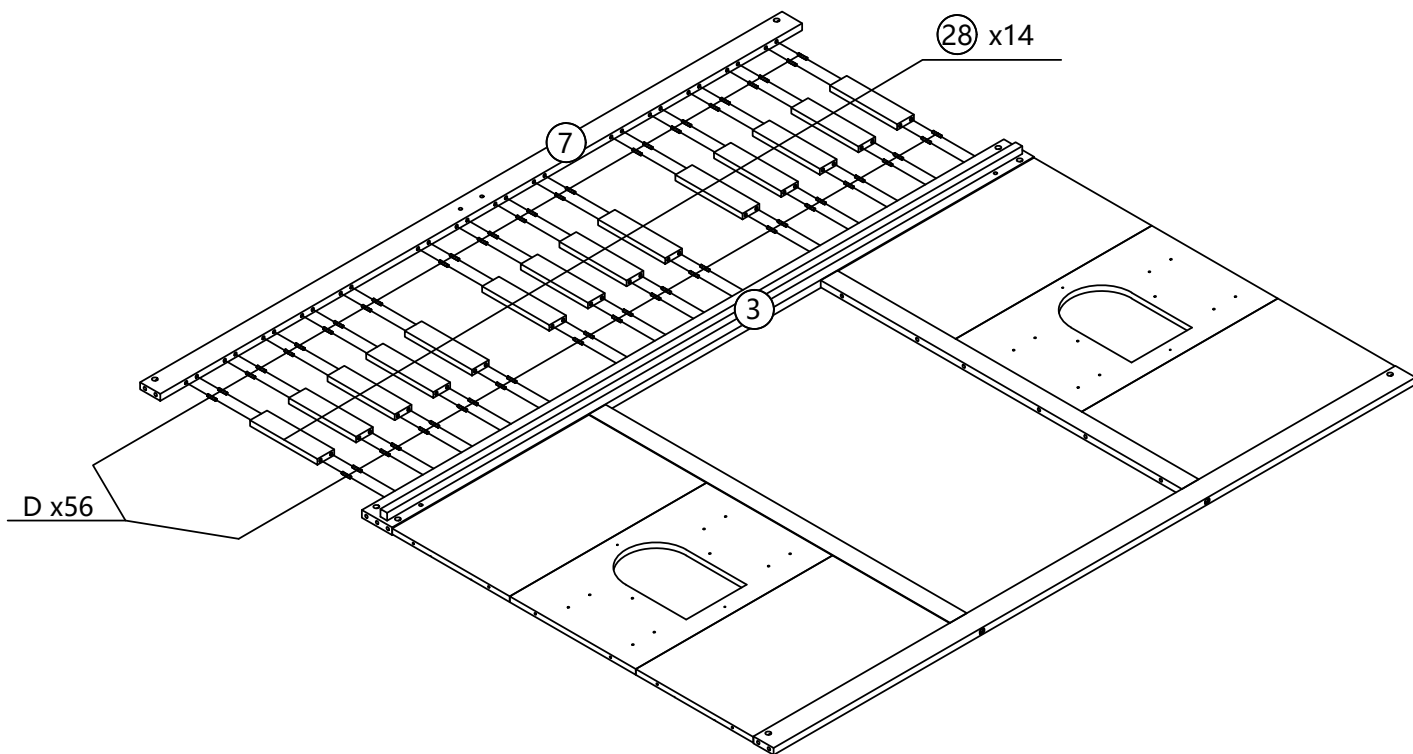
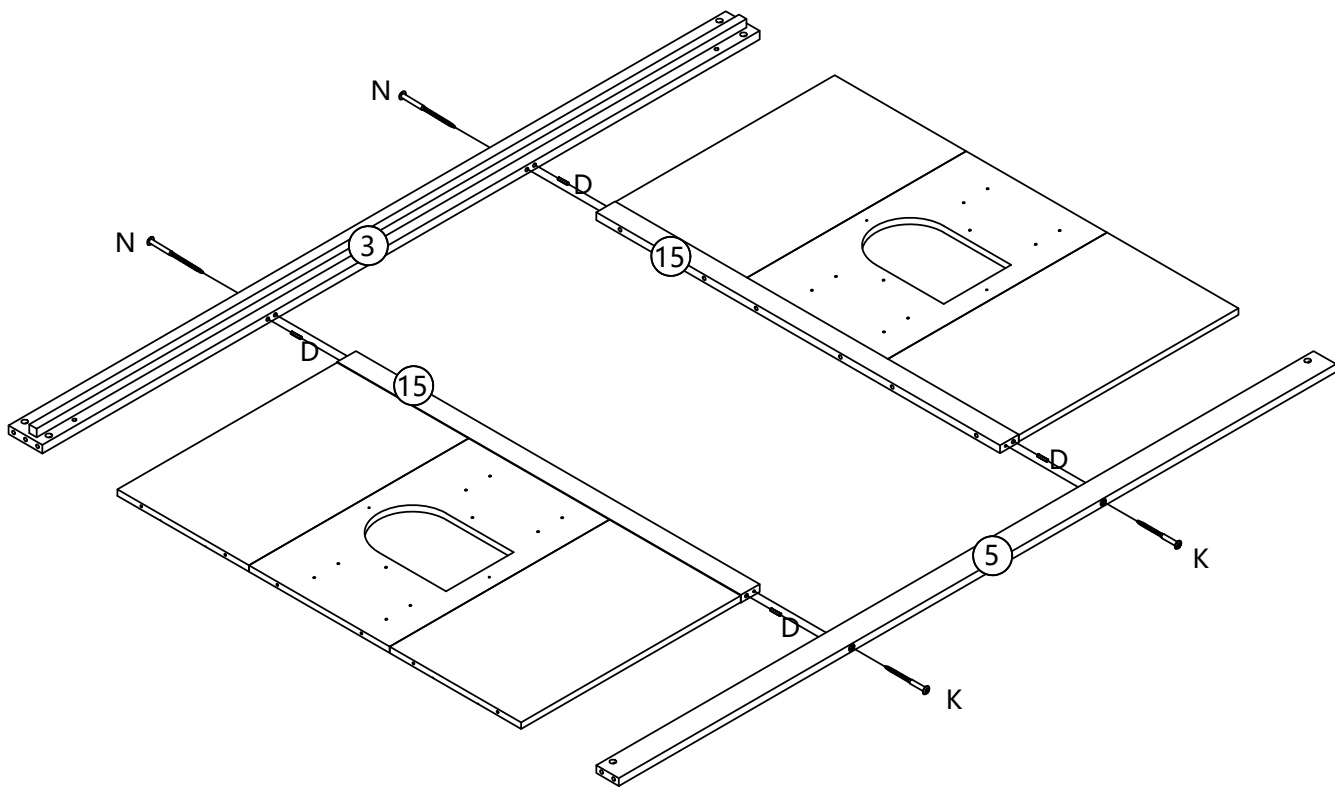
STEP:2



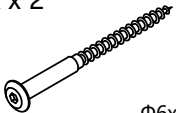

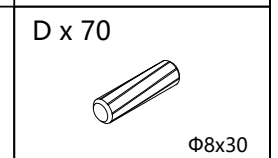
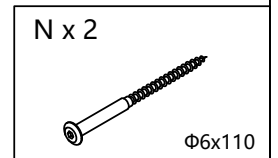
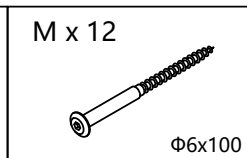
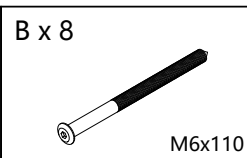
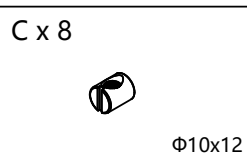
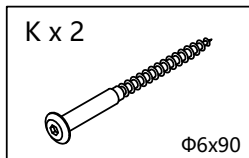
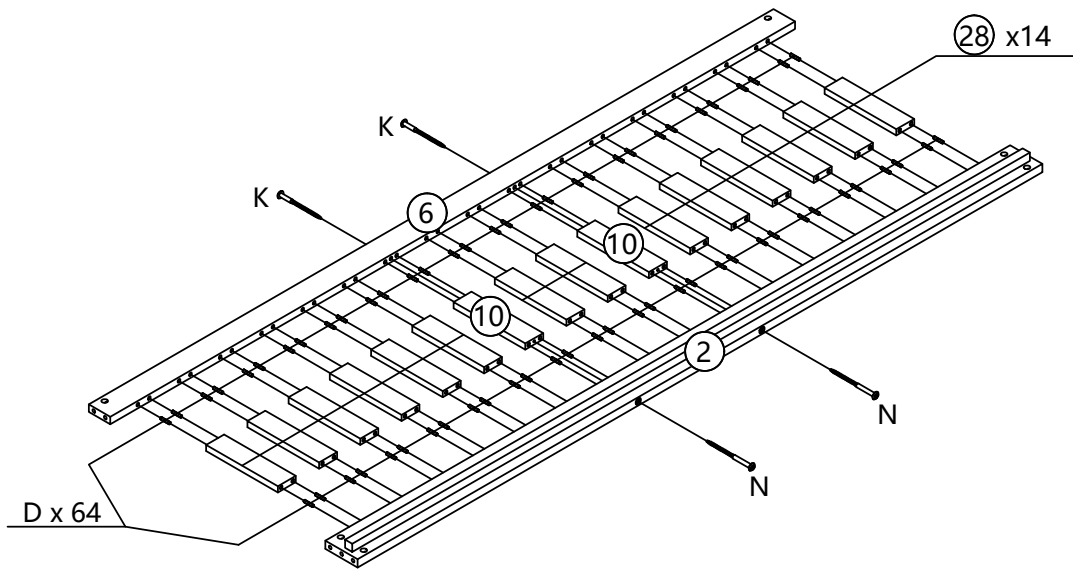
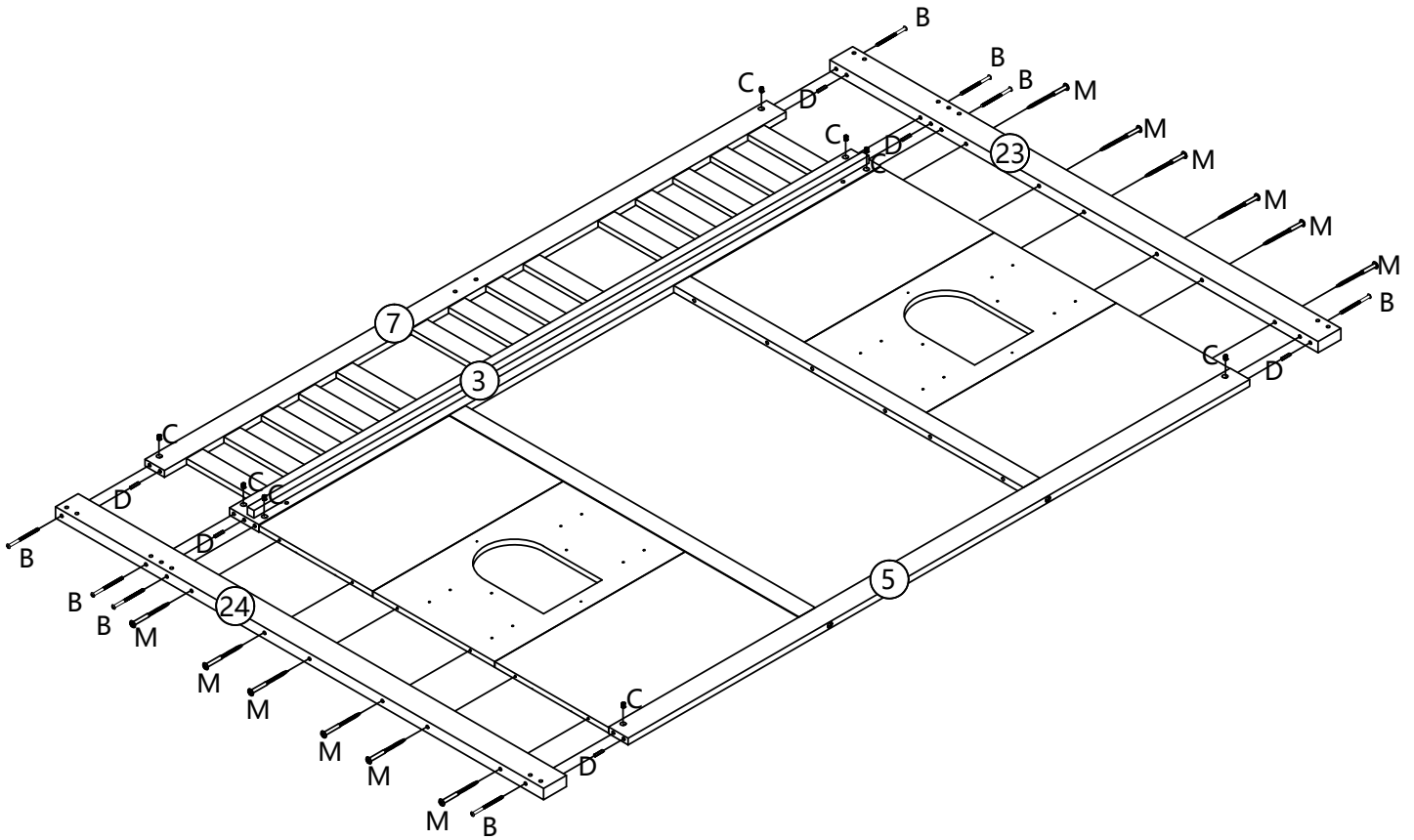

D x 60  $\Phi 8 \times 30$	N x 2  $\Phi 6 \times 110$	K x 2  $\Phi 6 \times 90$
--	--	---

STEP:3

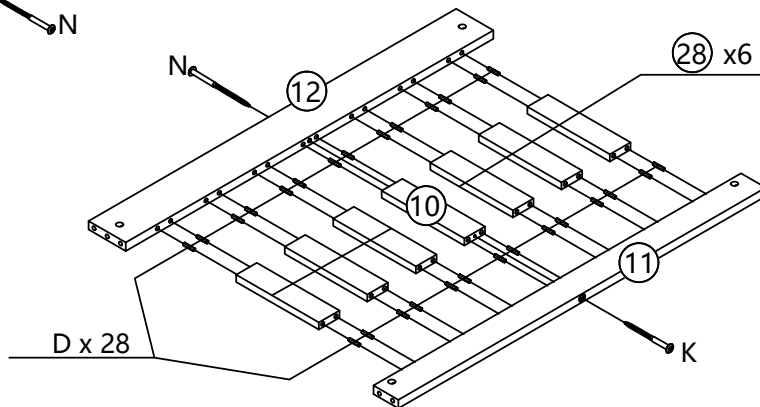
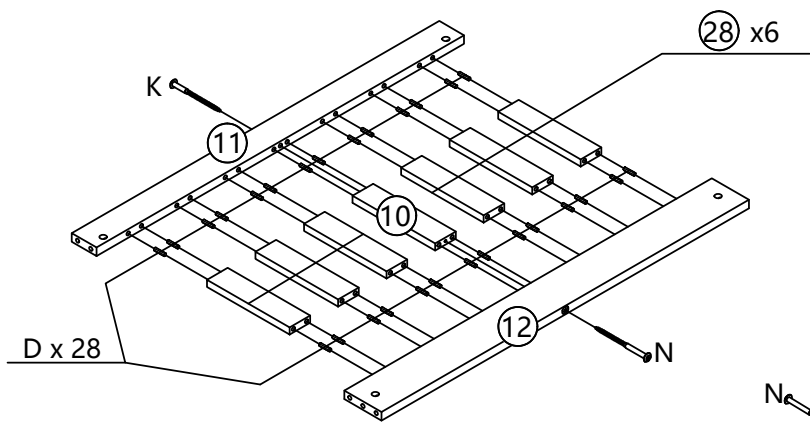
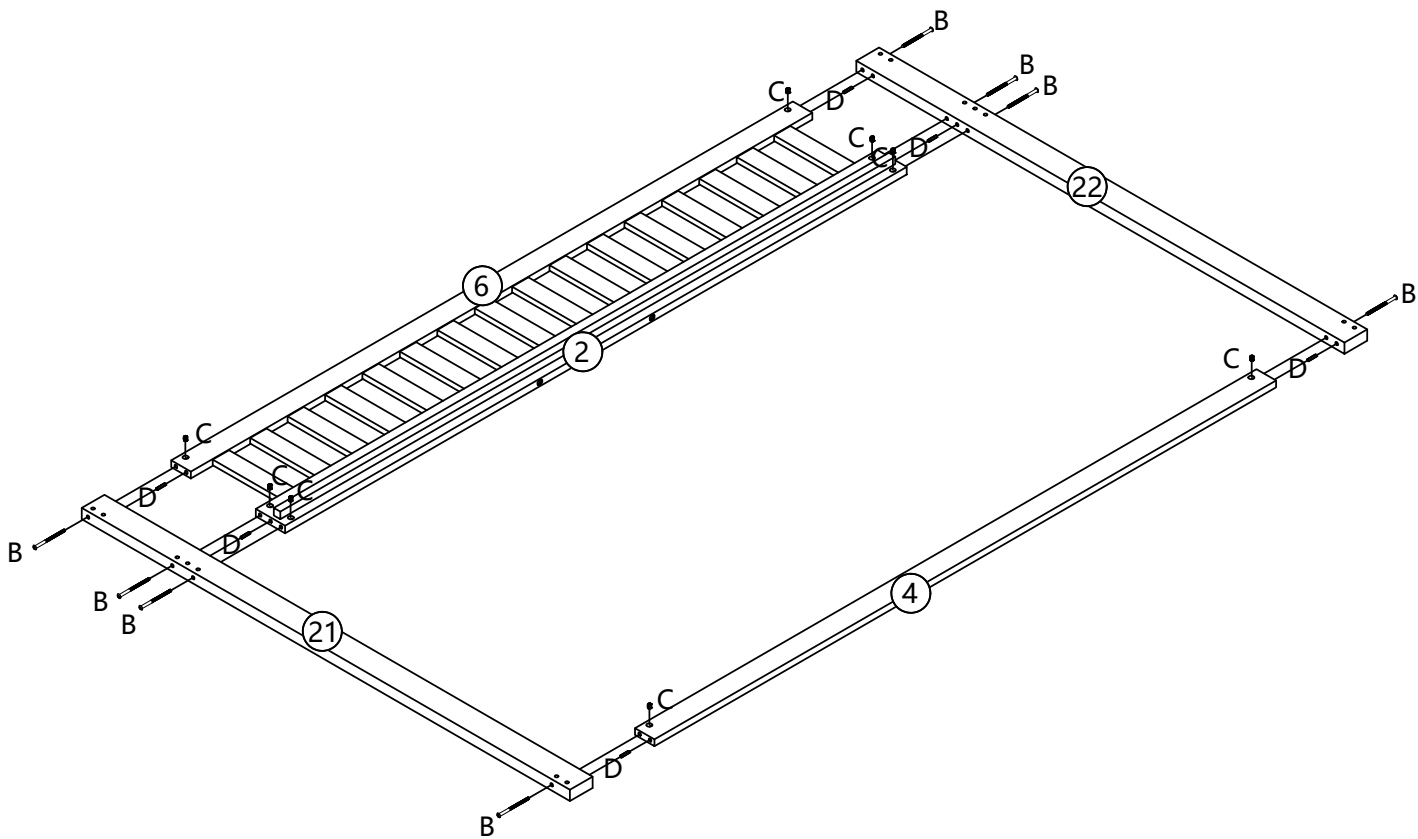



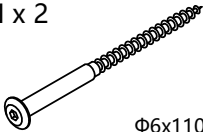
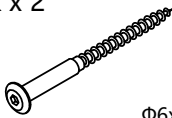

STEP:4

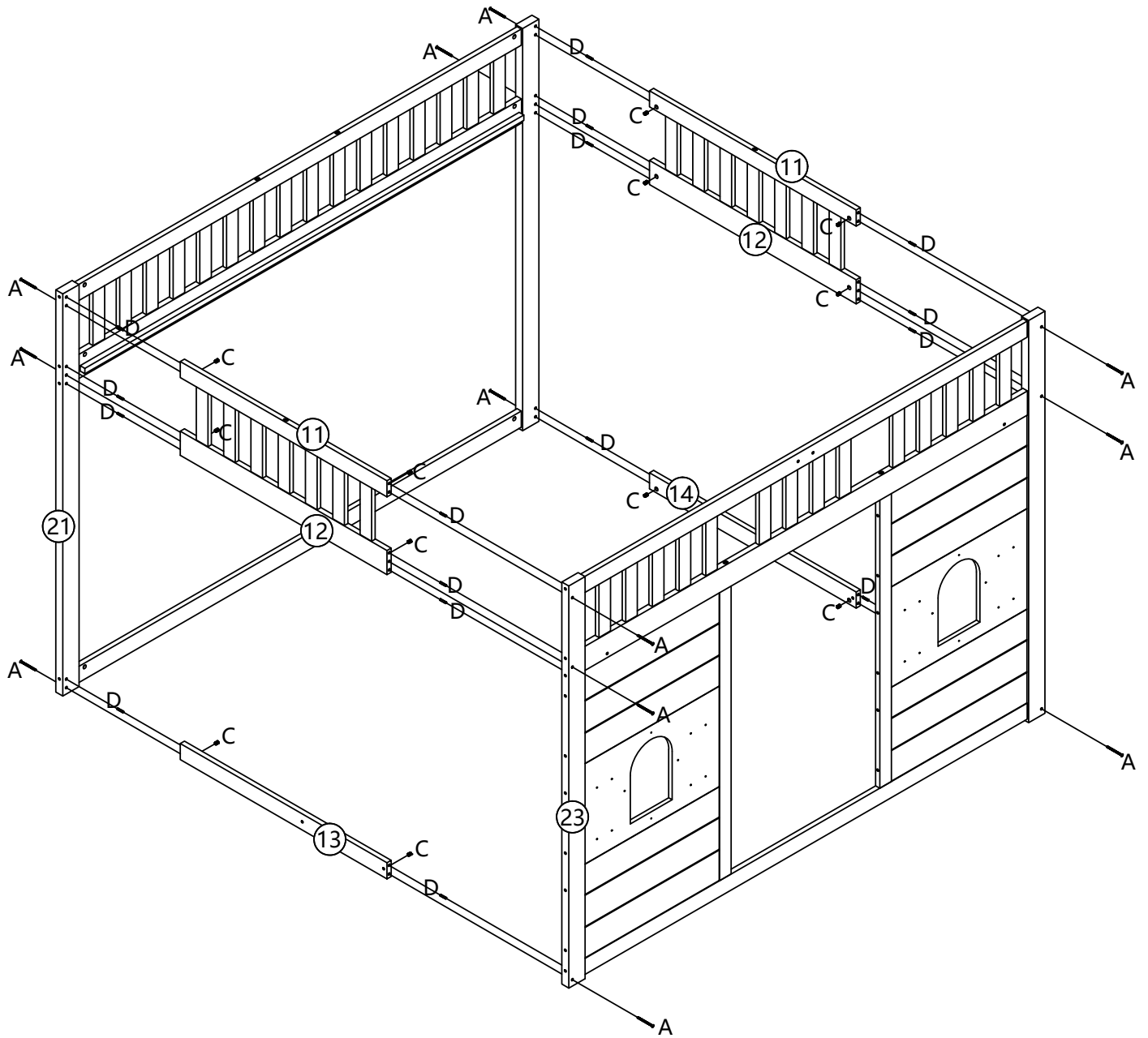

<p>C x 8</p>  <p>Φ10x12</p>	<p>B x 8</p>  <p>M6x110</p>	<p>N x 2</p>  <p>Φ6x110</p>	<p>K x 2</p>  <p>Φ6x90</p>	<p>D x 62</p>  <p>Φ8x30</p>
--	--	---	---	--

STEP:5



<p>C x 12</p>  <p>Φ10x12</p>	<p>D x 16</p>  <p>Φ8x30</p>	<p>A x 12</p>  <p>M6x70</p>
---	--	--

STEP:6

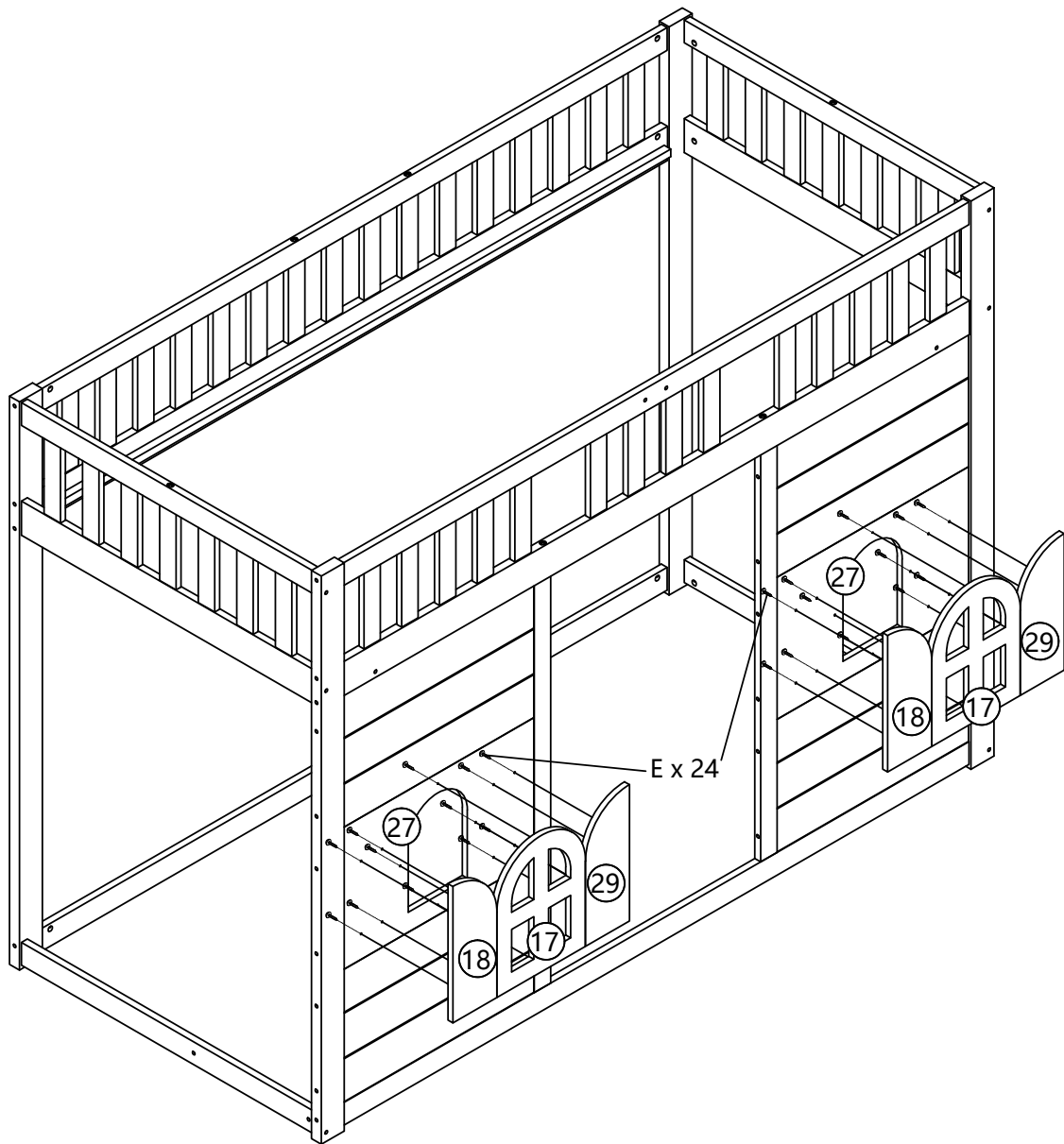



E x 24

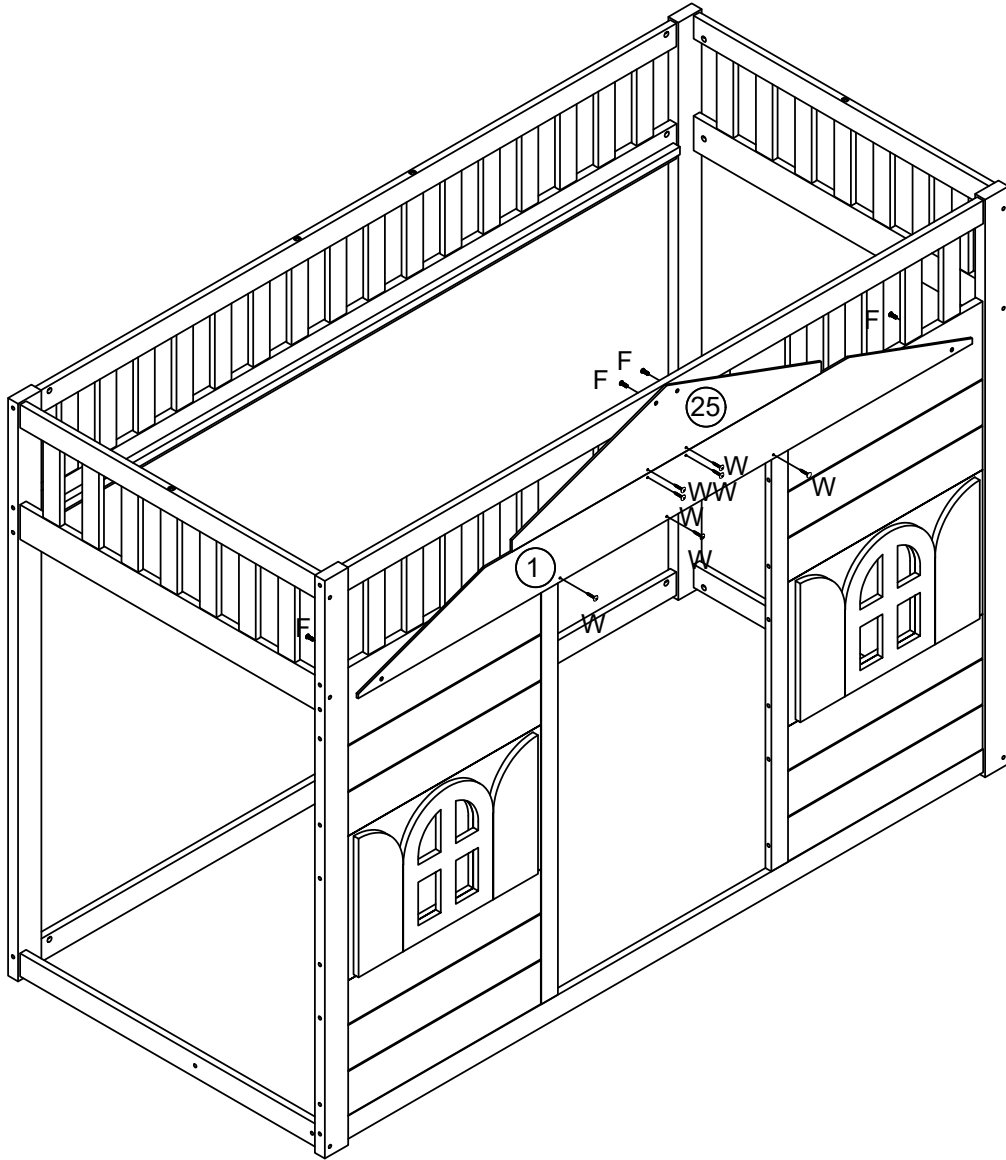

Φ4x25

STEP:7



<p>W x 7</p>  <p>Φ4x15</p>	<p>F x 4</p>  <p>M6x30</p>
---	---

STEP:8

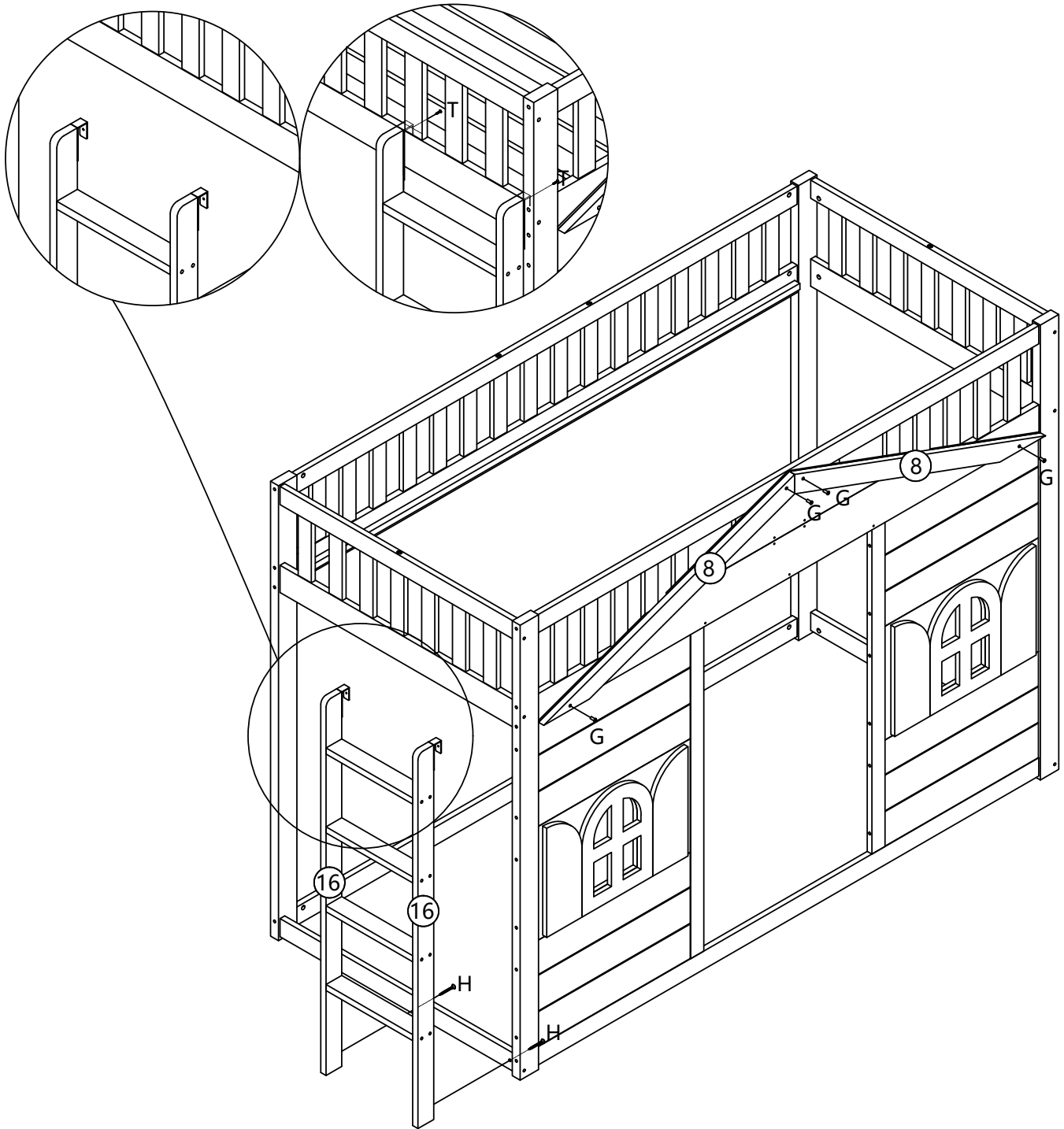

H x 2

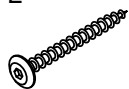

Φ6x50

T x 2



Φ4x15

G x 4



M6x20

STEP:9

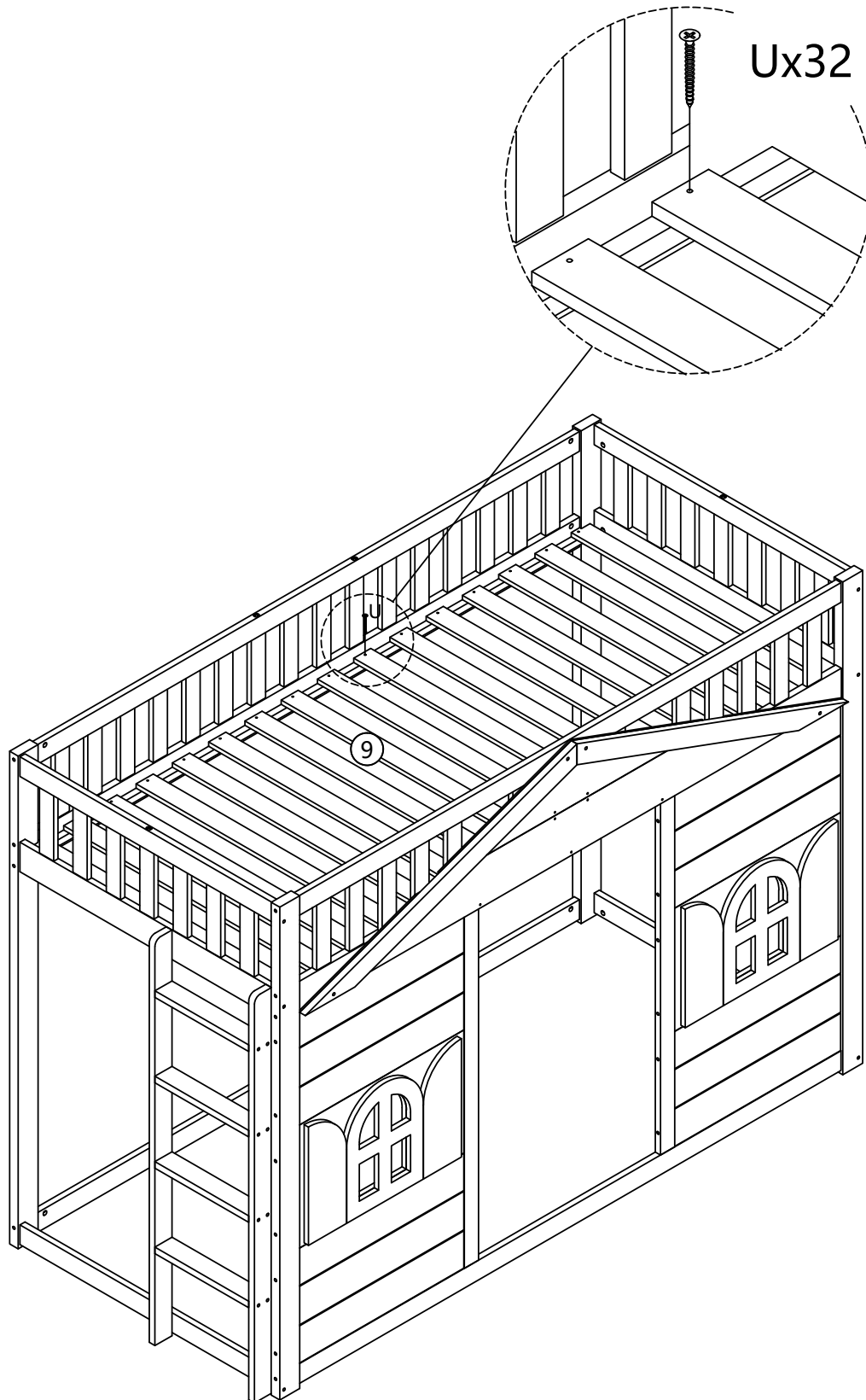

Ux32

U x 32

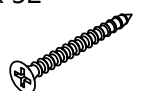

Φ4x30

STEP:10

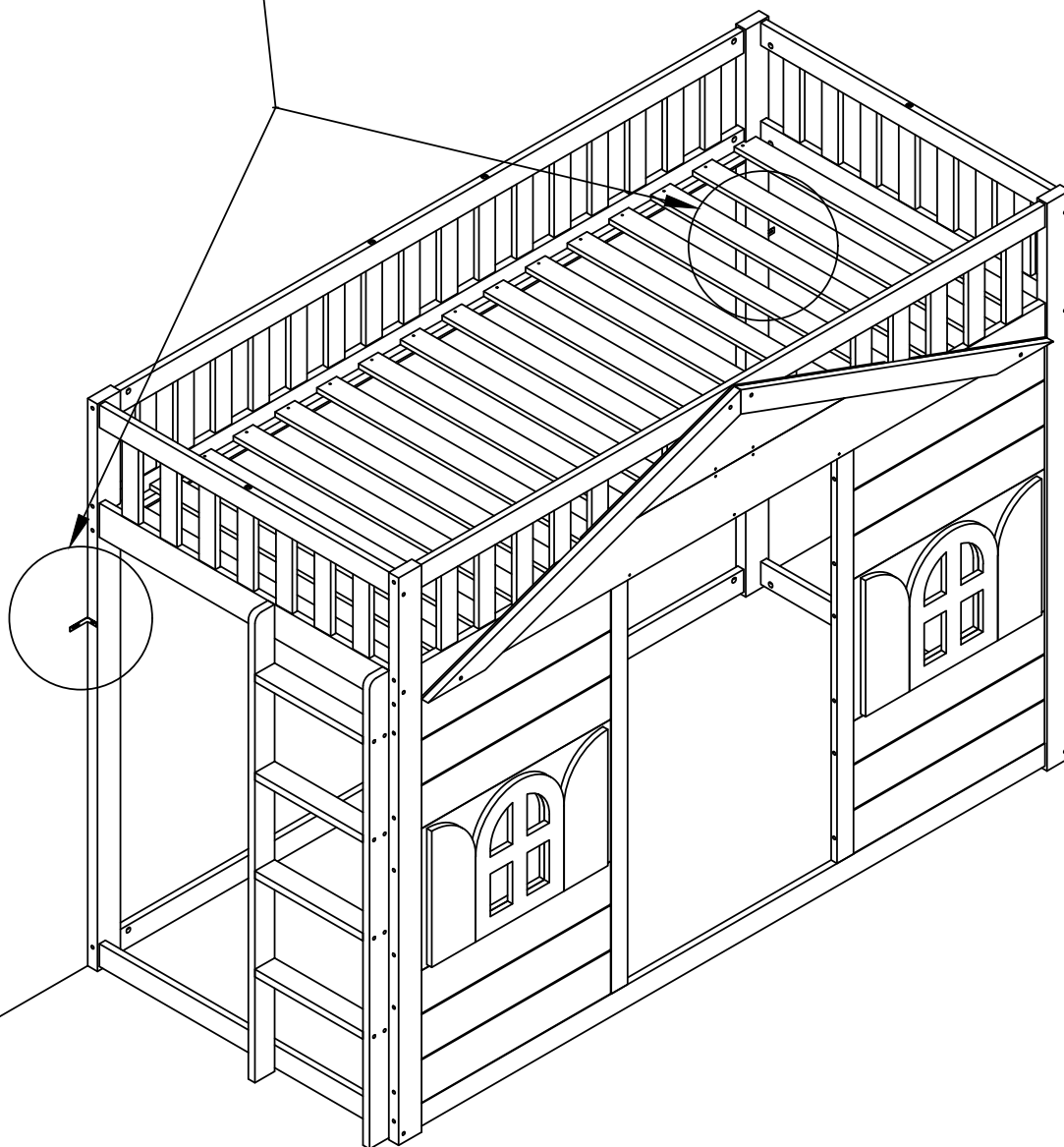
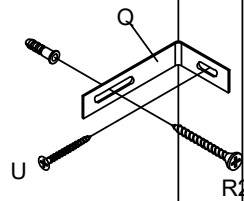
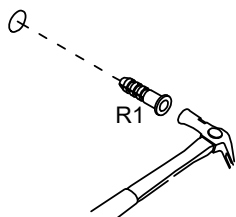
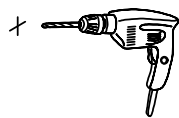

Q x 2

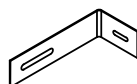

R x 2



R1

R2

U x 2



Φ4x30