

# BOX-1 N625P430671W

# BOX-2 N625P430672W

Product manual

Gebrauchsanweisung

Manuel du produit

Manual del producto

Manuale del prodotto

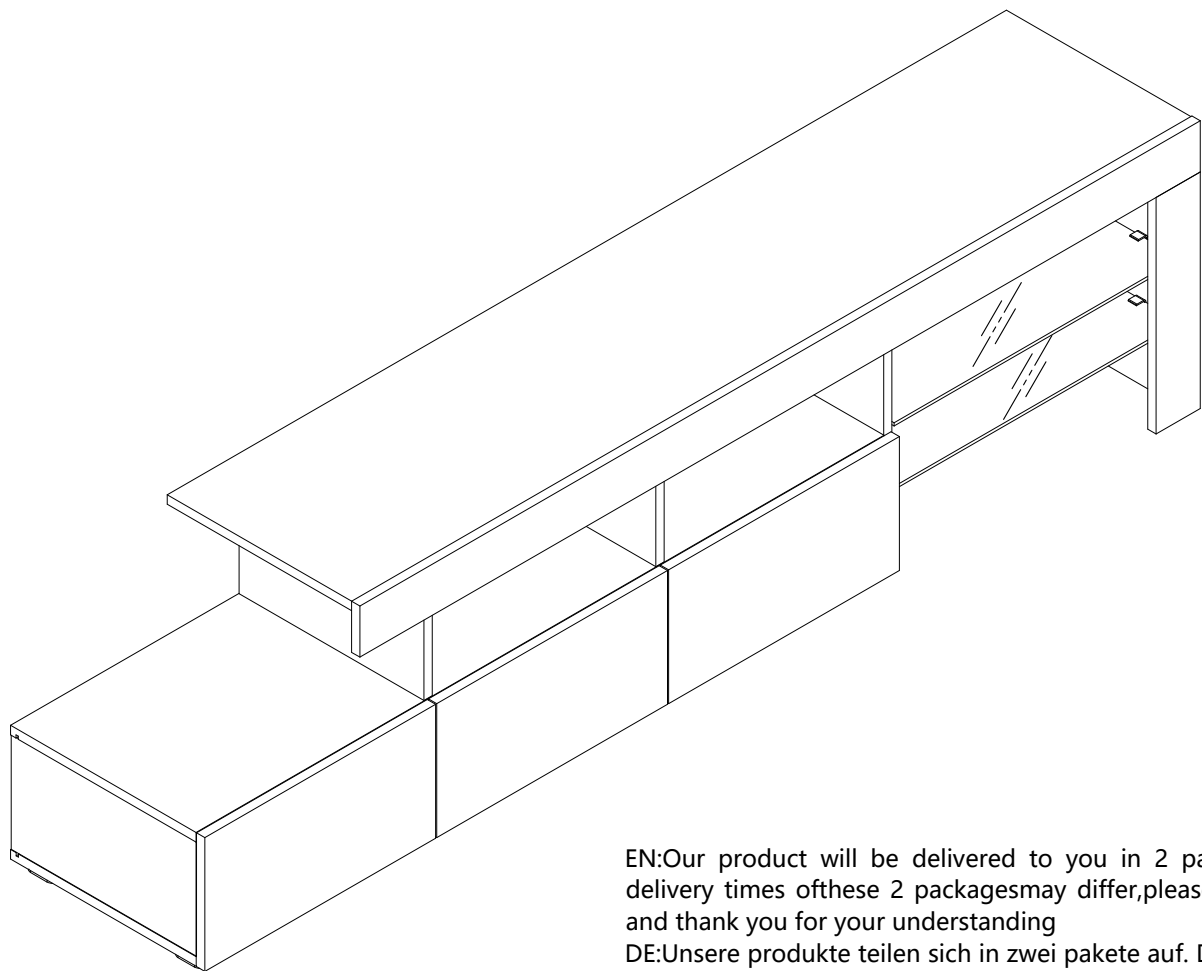

EN:Our product will be delivered to you in 2 packages.The delivery times ofthese 2 packagesmay differ,pleasebe patient and thank you for your understanding

DE:Unsere produkte teilen sich in zwei pakete auf. Dielieferung der beiden pakete kann je nach jahreszeitvariieren, so warten sie bitte geduldig und danken sie fürihr verständnis

FR:Notre produit vous sera livré en 2 paquets. Les délaisde livraison de ces 2 colis peuvent différer, soyez patientet merci de votre compréhension

ES:Nuestro producto le será entregado en 2 paquetes. Los tiempos de entrega de estos 2 paquetes puedenvariar, por favor sea paciente y gracias por sucomprensión

IT:Il nostro prodotto sarà consegnato in 2 confezioni. I tempi di consegna di questi 2 pacchetti possono variare,per favore siate pazienti e vi ringrazio per la vostracomprendione



2PERS



55 MIN

Tool Required Not Provided

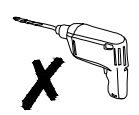
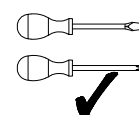



[DE]

**Warnung:** Lesen Sie die Anleitung vor dem Zusammenbau bitte vollständig durch. Überprüfen Sie, ob Sie alle auf den Seiten aufgeführten Komponenten und Werkzeuge haben.

**Warnung:** Legen Sie alle Teile auf eine ebene Fläche. Legen Sie eine weiche Decke oder Ähnliches darunter, um sie vor Kratzern oder Flecken zu schützen. Vermeiden Sie es, Komponenten über den Boden zu ziehen oder zu schieben.

**Warnung:** Überprüfen Sie regelmäßig alle Beschläge und Befestigungen, um sicherzustellen, dass sie sicher sind und um Unfälle zu vermeiden. Wenn Teile fehlen, kaputt, beschädigt oder abgenutzt sind, verwenden Sie das Produkt nicht weiter, bis es mit vom Hersteller autorisierten Teilen repariert wurde.

**Warnung:** Lassen Sie Kinder nicht auf die Möbel klettern, da dies zum Umkippen und zu schweren Verletzungen führen kann. Bauen Sie die Möbel außerhalb der Reichweite von Kindern zusammen.

**Warnung:** Stellen Sie die Möbel nicht in die Nähe von Feuerquellen oder heißen Gegenständen, um Brandgefahr zu vermeiden.

**Warnung:** Reinigen Sie die Möbel mit einem feuchten Tuch oder Alkohol. Verwenden Sie keine Reinigungsmittel mit ätzenden Chemikalien.

**Warnung:** Dieses Produkt ist mit einer Kippschutzvorrichtung ausgestattet. Bitte installieren Sie diese Vorrichtung unbedingt, um unnötige Verletzungen durch Umkippen zu vermeiden.

[EN]

**Warning:** Please read instructions fully before starting assembly. Check you have all the components and tools listed on pages.

**Warning:** Please place all parts on a flat surface. Place a soft blanket or similar underneath to protect against scratches or stains. Avoid dragging or sliding components across the floor.

**Warning:** Regularly check all fittings and fastenings to ensure they are secure and to prevent accidents. If any parts are missing, broken, damaged, or worn, discontinue use of the product until repairs have been made using factory authorized parts.

**Warning:** Do not allow children to climb on the furniture as this may result in tipping and serious personal injury. Assemble the furniture away from the reach of children.

**Warning:** Do not place furniture close to fire sources or high-temperature objects to avoid the risk of fire.

**Warning:** Clean furniture with a damp cloth or alcohol, avoid using cleaning agents containing corrosive chemicals.

**Warning:** This product is equipped with an anti-tilt device. Please be sure to install this device to prevent unnecessary injuries caused by tipping.

[FR]

**Avertissement :** Veuillez lire entièrement les instructions avant de commencer l'assemblage. Vérifiez que vous disposez de tous les composants et outils répertoriés sur les pages.

**Avertissement :** Veuillez placer toutes les pièces sur une surface plane. Placez une couverture douce ou similaire en dessous pour les protéger des rayures ou des taches. Évitez de faire glisser les composants sur le sol.

**Avertissement :** Vérifiez régulièrement tous les raccords et fixations pour vous assurer qu'ils sont bien fixés et pour éviter les accidents. Si des pièces manquent, sont cassées, endommagées ou usées, cessez d'utiliser le produit jusqu'à ce que des réparations aient été effectuées à l'aide de pièces autorisées par l'usine.

**Avertissement :** Ne laissez pas les enfants grimper sur les meubles car cela pourrait entraîner un basculement et des blessures graves. Assemblez les meubles hors de portée des enfants.

**Avertissement :** Ne placez pas les meubles à proximité de sources de feu ou d'objets à haute température pour éviter tout risque d'incendie.



**Avertissement** : Nettoyez les meubles avec un chiffon humide ou de l'alcool, évitez d'utiliser des produits de nettoyage contenant des produits chimiques corrosifs.

**Avertissement** : Ce produit est équipé d'un dispositif anti-basculement. Assurez-vous d'installer ce dispositif pour éviter les blessures inutiles causées par un basculement.

[IT]

**Attenzione**: leggere attentamente le istruzioni prima di iniziare il montaggio. Verificare di avere tutti i componenti e gli strumenti elencati nelle pagine.

**Attenzione**: posizionare tutte le parti su una superficie piana. Posizionare una coperta morbida o simile sotto per proteggere da graffi o macchie. Evitare di trascinare o far scivolare i componenti sul pavimento.

**Attenzione**: controllare regolarmente tutti i raccordi e i dispositivi di fissaggio per assicurarsi che siano sicuri e per prevenire incidenti. Se alcune parti sono mancanti, rotte, danneggiate o usurate, interrompere l'uso del prodotto fino a quando non siano state eseguite le riparazioni utilizzando parti autorizzate dalla fabbrica.

**Attenzione**: non consentire ai bambini di arrampicarsi sui mobili poiché ciò potrebbe causare ribaltamenti e gravi lesioni personali. Montare i mobili lontano dalla portata dei bambini.

**Attenzione**: non posizionare i mobili vicino a fonti di fuoco o oggetti ad alta temperatura per evitare il rischio di incendio.

**Attenzione**: pulire i mobili con un panno umido o alcol, evitare di utilizzare detergenti contenenti sostanze chimiche corrosive.

**Attenzione**: questo prodotto è dotato di un dispositivo antiribaltamento. Assicurarsi di installare questo dispositivo per prevenire lesioni inutili causate dal ribaltamento.

[ES]

**Advertencia**: Lea las instrucciones completamente antes de comenzar el montaje. Compruebe que tiene todos los componentes y herramientas que se enumeran en las páginas.

**Advertencia**: Coloque todas las piezas sobre una superficie plana. Coloque una manta suave o algo similar debajo para protegerlas de rayones o manchas. Evite arrastrar o deslizar los componentes por el piso.

**Advertencia**: Verifique regularmente todos los accesorios y fijaciones para asegurarse de que estén seguros y evitar accidentes. Si falta alguna pieza, está rota, dañada o desgastada, deje de usar el producto hasta que se hayan realizado las reparaciones con piezas autorizadas de fábrica.

**Advertencia**: No permita que los niños se suban a los muebles, ya que esto puede provocar que se vuelquen y lesiones personales graves. Monte los muebles fuera del alcance de los niños.

**Advertencia**: No coloque los muebles cerca de fuentes de fuego u objetos de alta temperatura para evitar el riesgo de incendio.

**Advertencia**: Limpie los muebles con un paño húmedo o alcohol, evite usar agentes de limpieza que contengan químicos corrosivos.

**Advertencia**: Este producto está equipado con un dispositivo antivuelco. Asegúrese de instalar este dispositivo para evitar lesiones innecesarias causadas por vuelcos.

EN

Dear customer,  
Thank you for purchasing this product. So that your appliance serves you well, please read all the instructions in this user's manual. If you have any questions, please contact our customer care center.

FR

Cher client,  
Nous vous remercions d'avoir acheté ce produit. Afin que vous puissiez profiter pleinement de votre appareil, veuillez lire toutes les instructions de ce manuel d'utilisation. Si vous avez la moindre question, veuillez contacter notre centre d'assistance à la clientèle.

DE

Sehr geehrter Kunde,  
Vielen Dank, dass Sie dieses Produkt erworben haben. Damit Ihr Gerät Ihnen gute Dienste leistet, lesen Sie bitte alle Hinweise in diesem Benutzerhandbuch. Wenn Sie Fragen haben, wenden Sie sich bitte an unser Kundendienstzentrum.

ES

Queridos clientes,  
Gracias por comprar este producto. Para que su electrodoméstico le sirva mejor, lea todas las instrucciones de este manual del usuario. Si tiene alguna pregunta, comuníquese con nuestro Centro de Atención al Cliente.

IT

Caro Cliente,  
Grazie per aver acquistato questo prodotto. Per servirti meglio con questo apparecchio ti prego di leggere tutte le istruzioni in presente manuale utente. In caso di dubbio, si prega di contattare il nostro centro assistenza clienti.

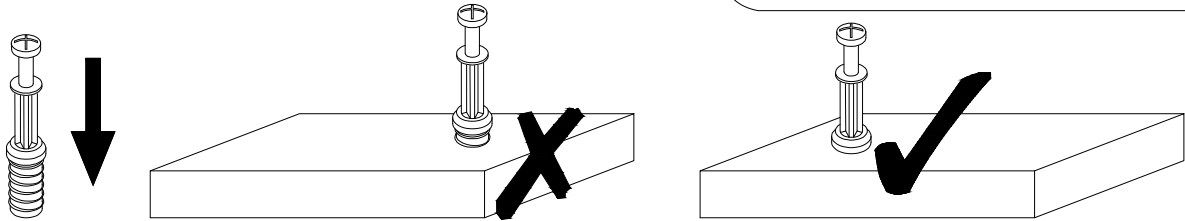

EN QUICKFIT: Tighten quickfit until shoulder is flush with panel. Do not overtighten or undertighten.

FR RACCORD RAPIDE: Faites serrer le raccord rapide jusqu'à ce que l'épaulement soit parfaitement encastré dans le panneau. Il ne faut ni trop serrer ni insuffisamment serrer.

ES QUICKFIT: Apriete quickfit hasta que el hombro se descargue con el panel. NO lo sobreapriete ni lo apriete poco.

DE QUICKFIT: Ziehen Sie den Quickfit fest, bis die Schulter mit der Platte bundig ist. Bitte nicht zu fest oder zu schwach anziehen.

IT\_MONTAGGIO RAPIDO: Stringere il montaggio rapido fino a quando la spalla è a filo con il pannello, non stringere troppo o troppo poco.

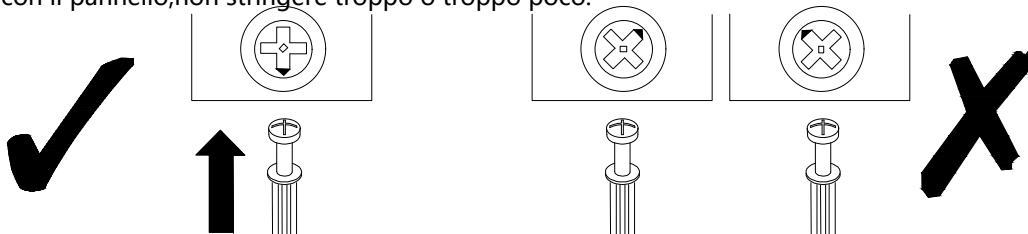

EN CAM LOCK: When fitting cam lock, ensure starting position is correct before you insert connecting quickfit.

FR SERRURE BATTEUSE: Avant d'insérer la serrure batteuse, veillez à la bonne orientation avant d'insérer le raccord rapide.

ES CIERRE DE LA CAMARA: Cuando instale el cierre de la cámara, asegúrese de que la posición de inicio es correcta antes de que inserte el quickfit conector.

DE\_CAM-LOCK: Achten Sie bei der Montage des Cam-Locks auf die richtige Ausgangsposition, bevor Sie den Quickfit einsetzen.

IT\_BLOCCAGGIO A CAMMA: Quando si monta il bloccaggio a camma, assicurarsi che la posizione iniziale sia corretta prima di inserire il montaggio rapido di collegamento

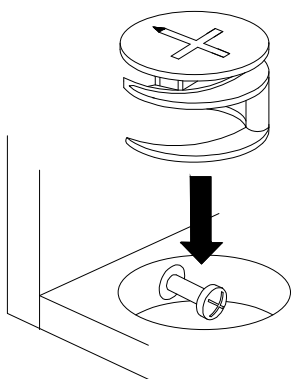

EN Quickfit head should be in the centre of the cam lock when the two panels are joined.

Cam lock should be inserted before quickfit.

FR\_Lorsque les deux panneaux sont assemblés, la tête du raccord rapide doit reposer au centre de la serrure batteuse.

Il faut insérer la serrure batteuse avant le raccord rapide.

ES\_El cabezal del quickfit debe estar en el centro del cierre de la cámara cuando se unan los dos paneles.

Se debe insertar el cierre de la cámara antes que el quickfit.

DE\_Der Quickfit-Kopf sollte sich in der Mitte des Cam-Locks befinden, wenn die beiden Platten zusammengefügt sind.

Der Cam-Lock sollte vor dem Quickfit eingesetzt werden.

IT\_La testa del montaggio rapido deve trovarsi al centro del bloccaggio a camma quando i due pannelli sono uniti.

Il Bloccaggio a Camma deve essere inserito prima del montaggio rapido.

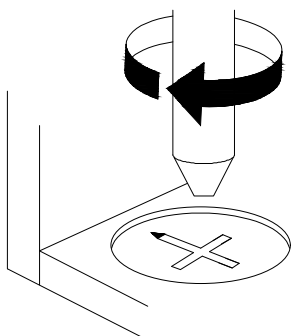

EN Turn cam lock clockwise to tighten.

FR Faites tourner la serrure batteuse dans le sens des aiguilles d'une montre pour la resserrer.

ES Gire el cierre de la cámara en sentido horario para apretarlo.

DE Drehen Sie den Cam-Lock im Uhrzeigersinn, um ihn festzuziehen.

IT Ruotare il bloccaggio a camma in senso orario per stringere.

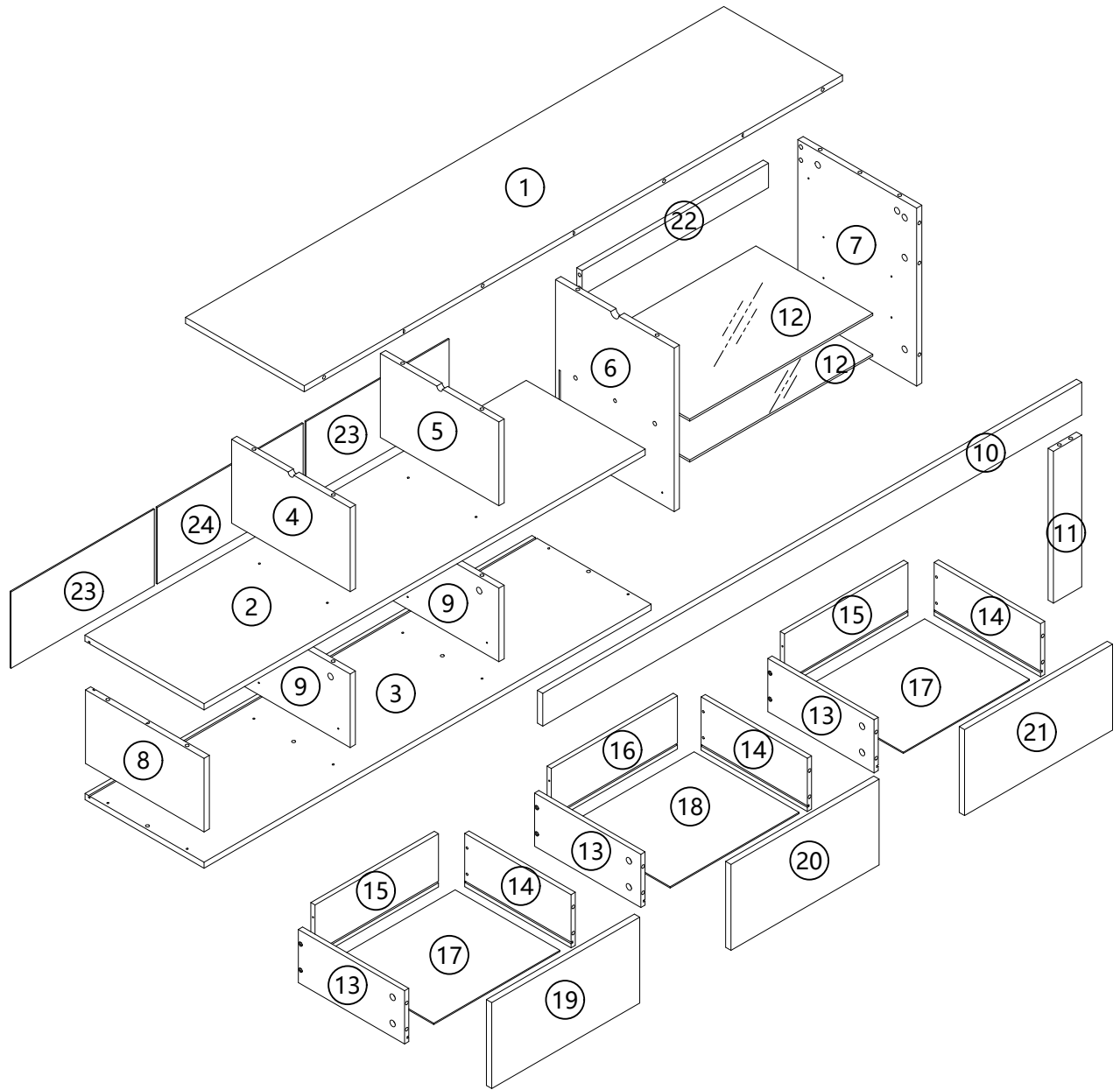

# N625P430671W

①

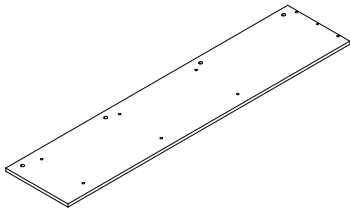

1

②

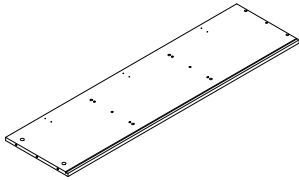

1

③

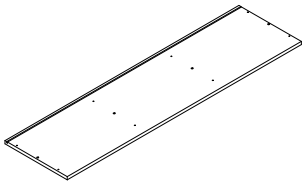

1

⑩

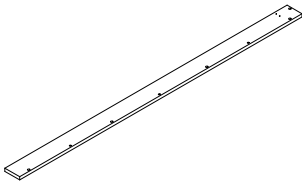

1

# N625P430672W

④

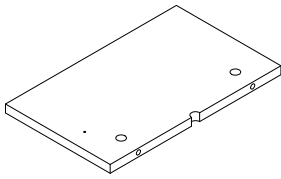

1

⑤

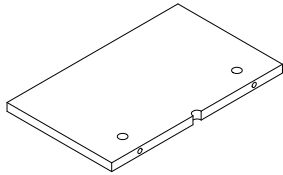

1

⑥

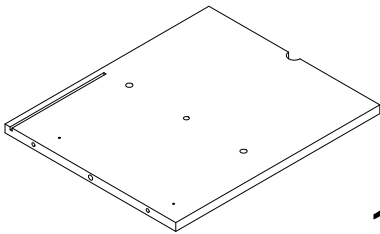

1

⑦

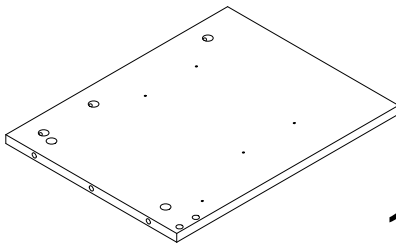

1

⑧

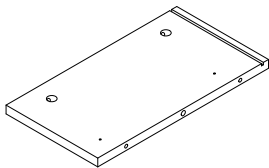

1

⑨

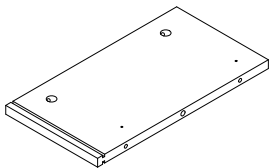

2

⑪

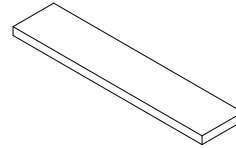

1

⑫

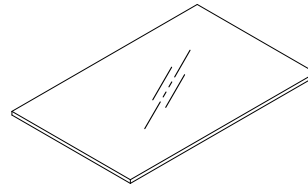

2

⑬

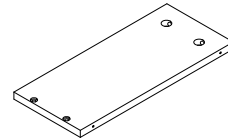

3

⑭

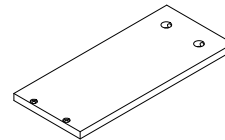

3

⑮

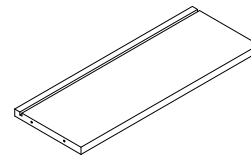

2

⑯

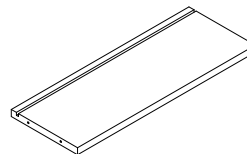

1

# N625P430672W

17

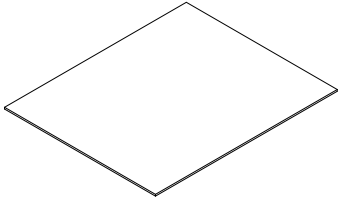

2

18

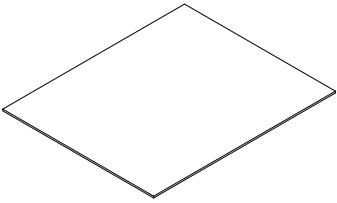

1

19

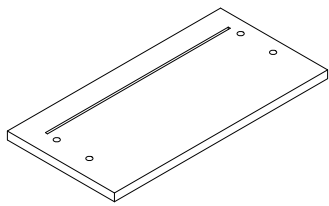

1

20

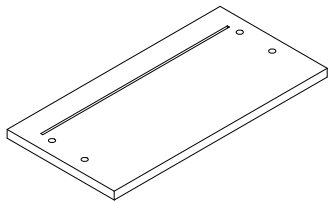

1

21

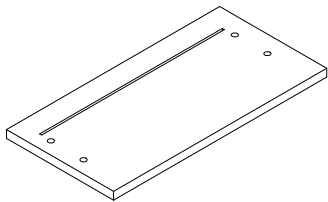

1

22

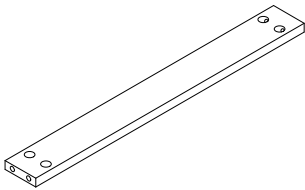

1

23

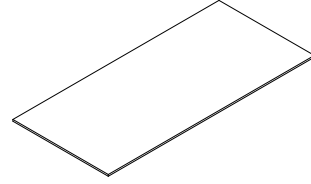





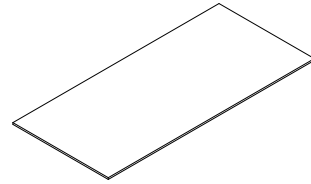

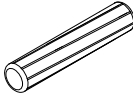

2

24

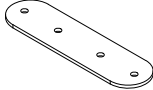

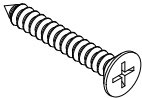
1

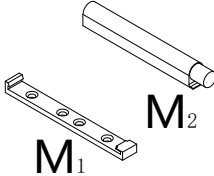
# N625P430672W

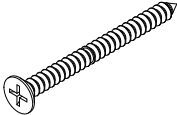
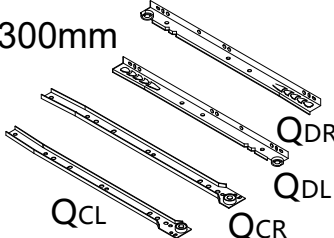
<p><b>Ax40</b></p>  <p>Ø6*40</p>	<p><b>Bx40</b></p>  <p>Ø15*9.5</p>	<p><b>Cx13</b></p>  <p>Ø8*40</p>	<p><b>Dx40</b></p>  <p>M3.5*14</p>
<p><b>Ex2</b></p>  <p>M3.5*35 M6*30</p>	<p><b>Fx2</b></p>  <p>M4*12</p>	<p><b>Gx1</b></p> 	<p><b>Hx8</b></p> 
<p><b>Ix12</b></p> 	<p><b>Jx12</b></p>  <p>M3.5*25</p>	<p><b>Kx52</b></p>  <p>Ø20</p>	<p><b>Lx12</b></p>  <p>M7*50</p>
<p><b>Mx3</b></p>  <p>M<sub>1</sub> M<sub>2</sub></p>	<p><b>Nx5</b></p> <p>Ersatzteil</p> 	<p><b>Ox1</b></p> 	<p><b>Px12</b></p>  <p>M3.5*35</p>
<p><b>Qx3</b></p> <p>300mm</p>  <p>QCL QDL QCR</p>	<p><b>Rx6</b></p> 	<p><b>Sx12</b></p>  <p>M3.5*12</p>	

EN:If you find that the white glue particles on the board are missing, please press part **N** into the board.

DE:Sollten Sie feststellen, dass die weißen Gummipartikel auf der Platine fehlen, drücken Sie bitte Teil **N** in die Platine.





FR:Si vous constatez qu'il manque des particules de caoutchouc blanc sur le tableau, veuillez enfoncer la partie **N** dans le tableau.

IT:Se trovi che mancano le particelle di gomma bianca sulla tavola, premi la parte **N** sulla tavola.

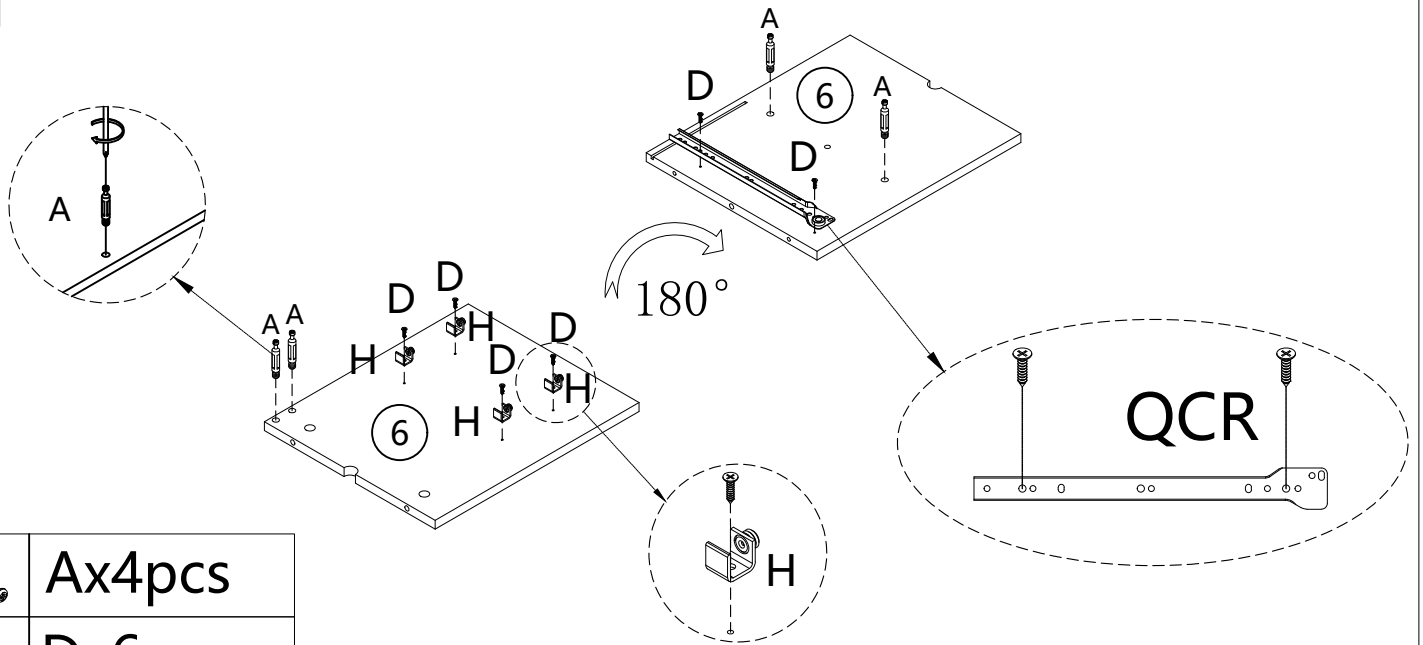
ES:Si descubre que faltan las partículas de goma blancas en el tablero, presione la parte **N** en el tablero.



# 1

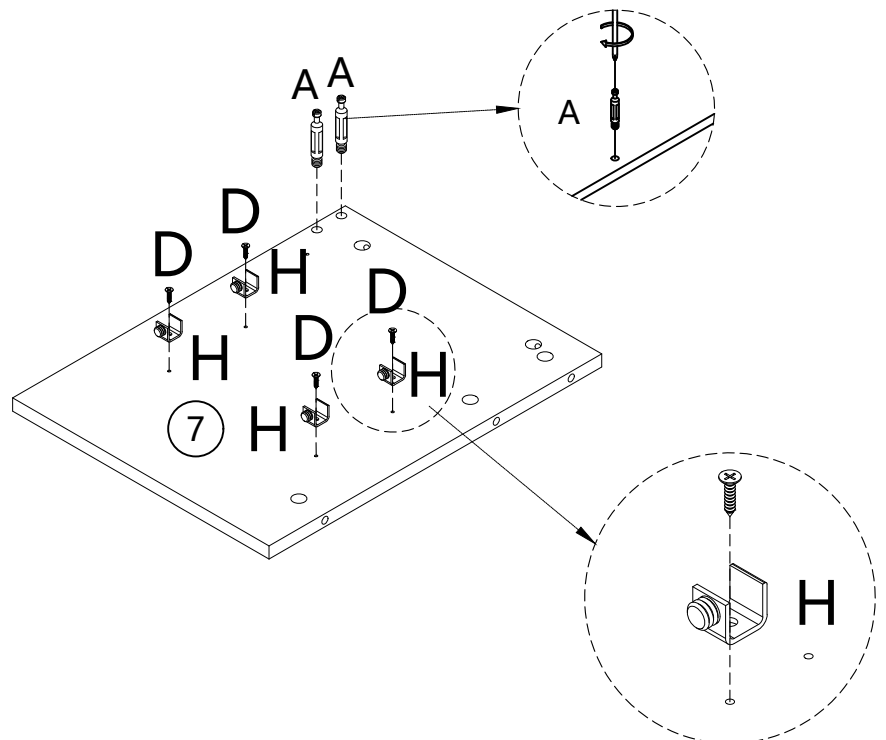

	Ax4pcs
	Dx6pcs
	Hx4pcs
	QCRx1pc

# 2



	Ax2pcs
	Dx4pcs
	Hx4pcs

3

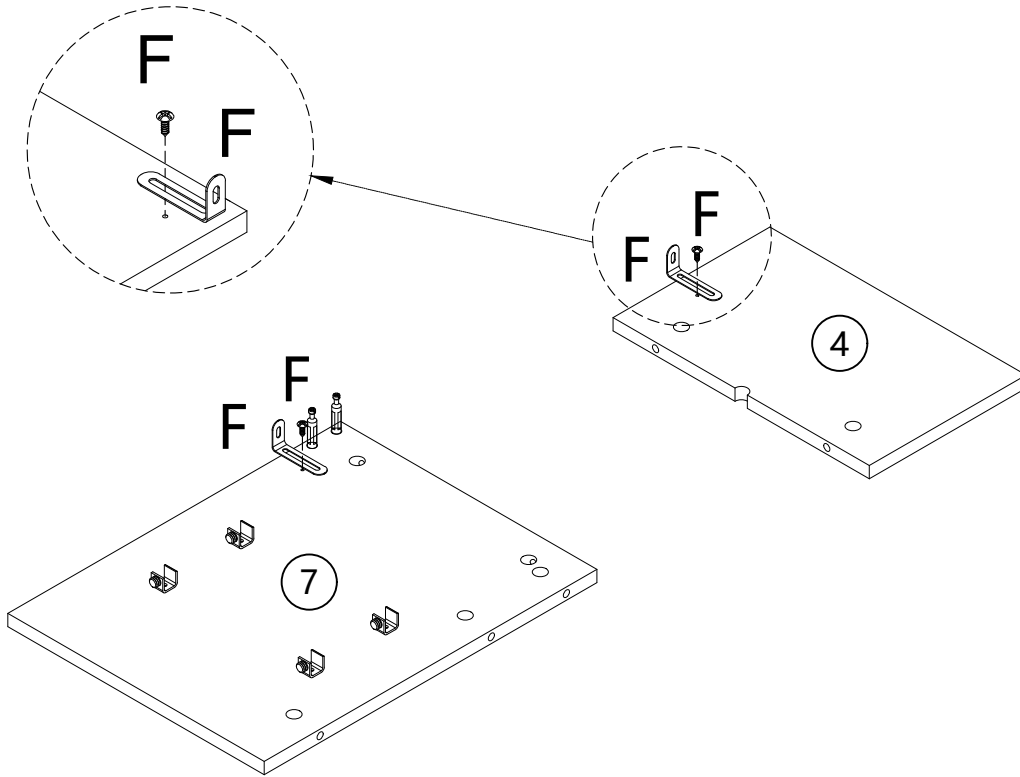

Fx2pcs

4

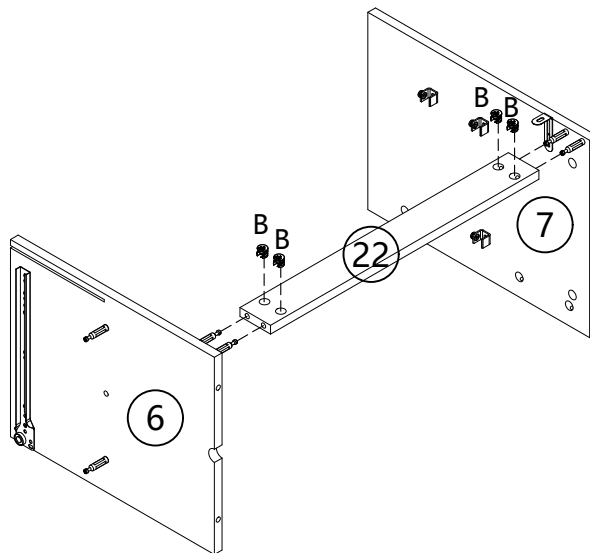

Bx4pcs

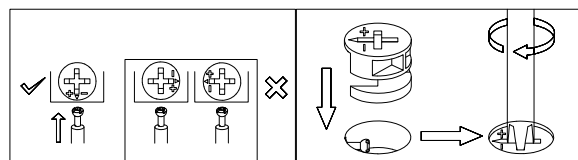

5

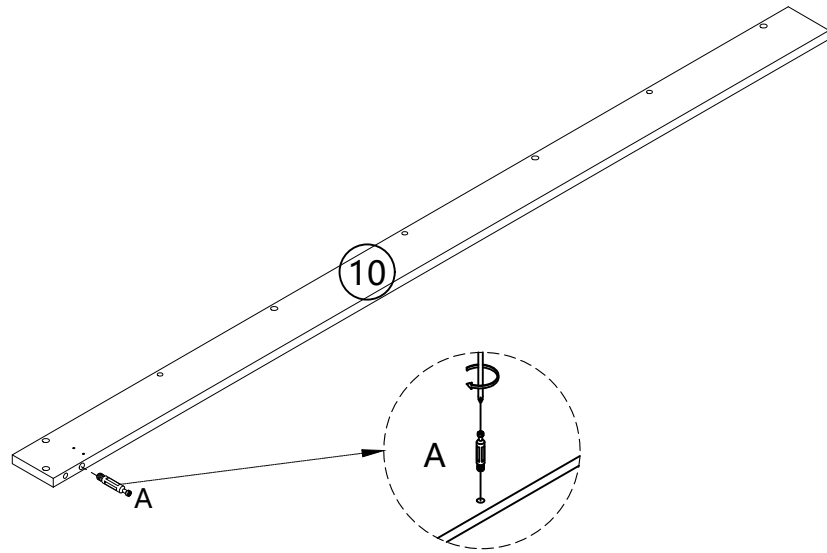

Ax1pc

6

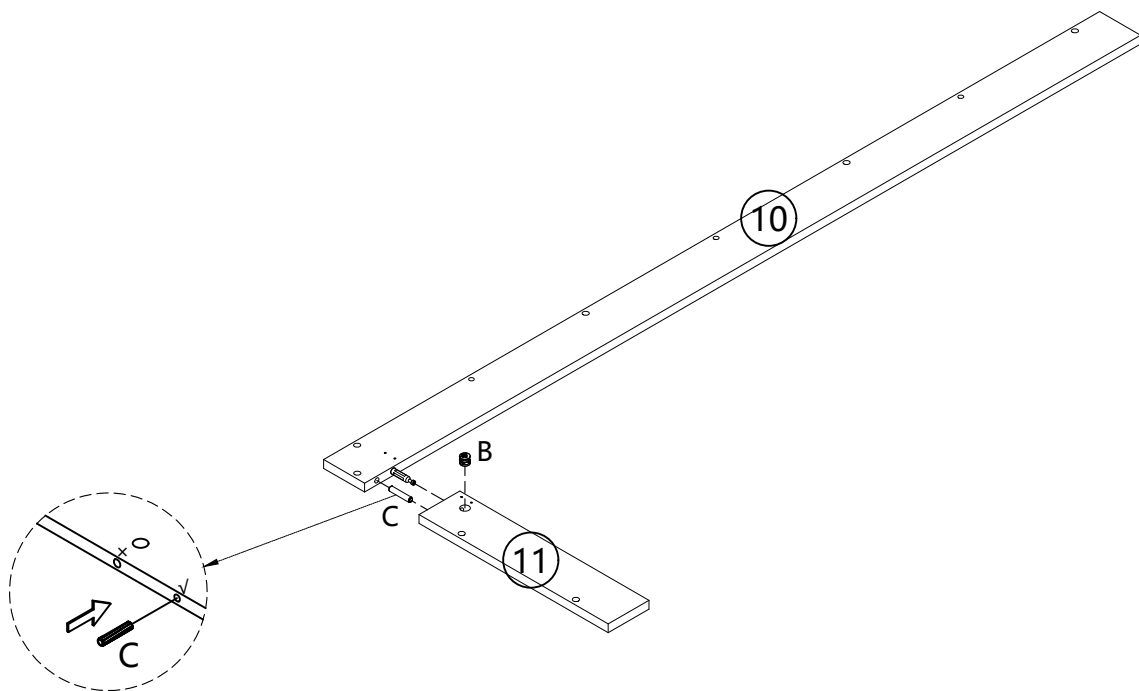

Bx1pc



Cx1pc

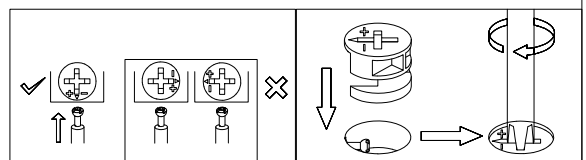

7

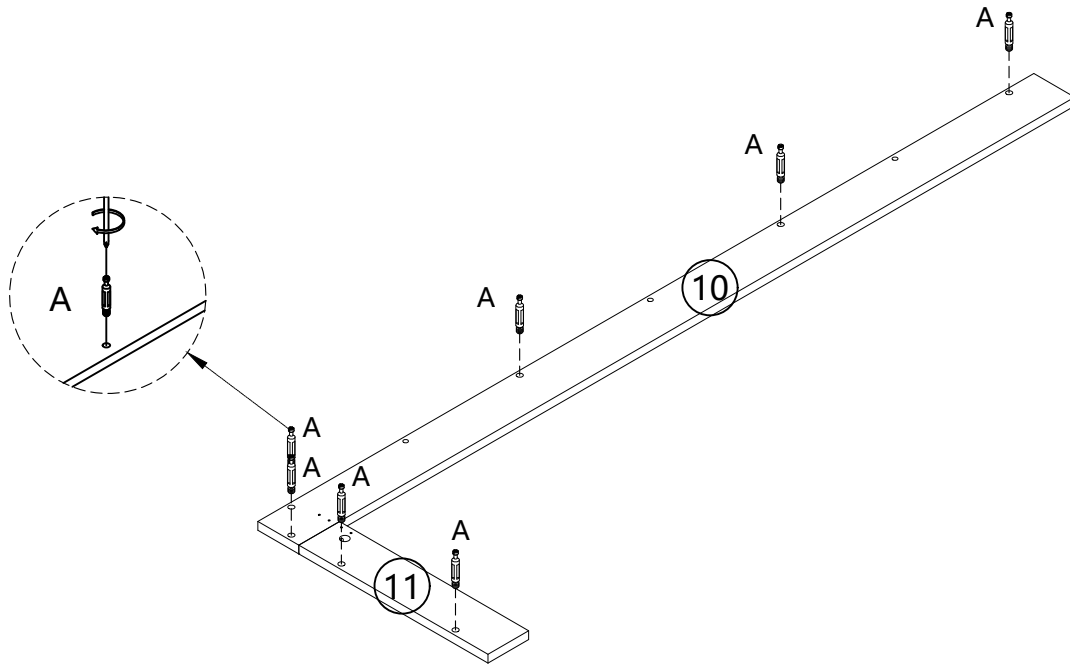

Ax7pcs

8

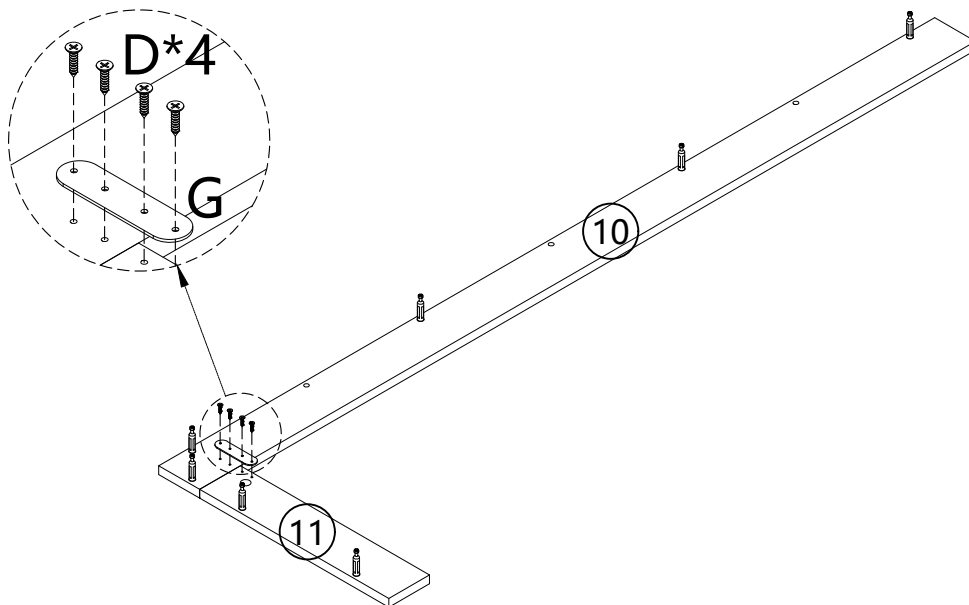

Dx4pcs



Gx1pc

# 9

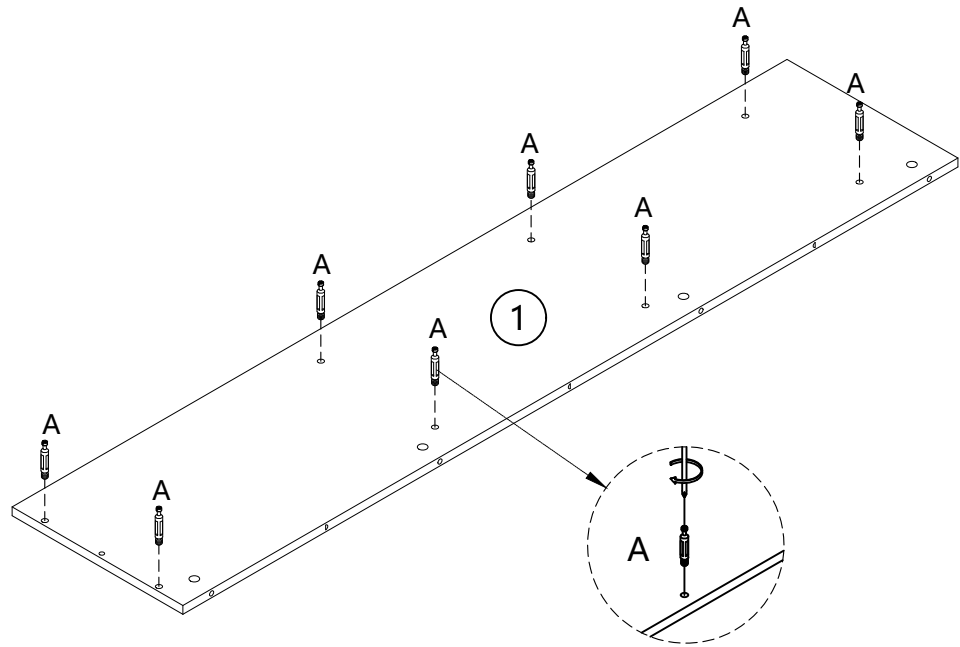

Ax8pcs

# 10

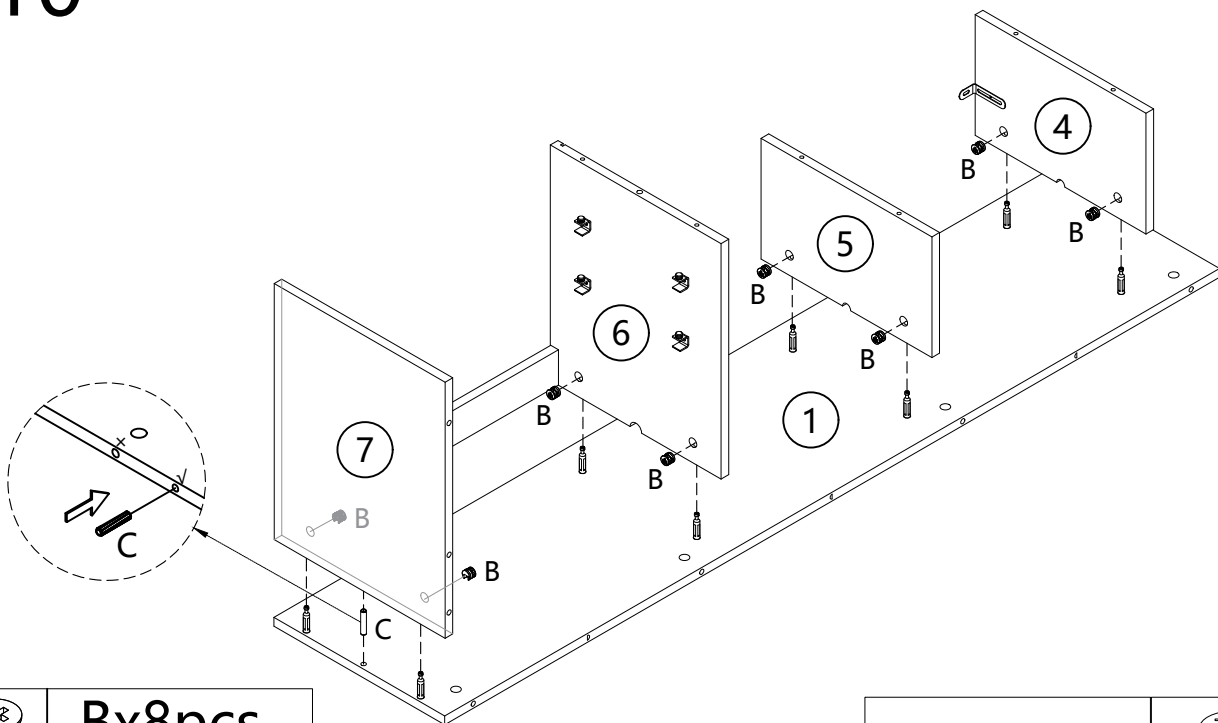

Bx8pcs



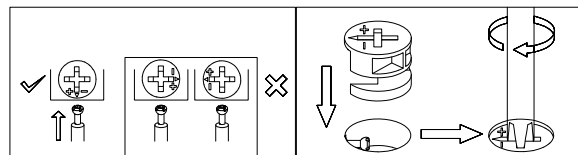

Cx1pc

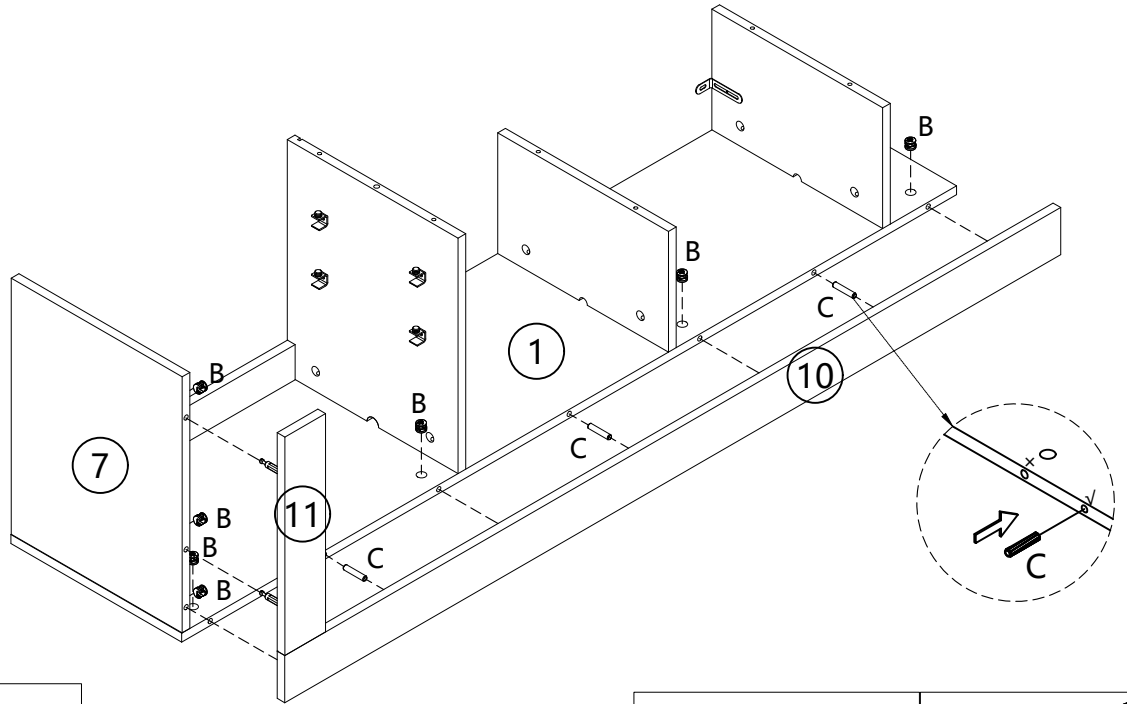

# 11



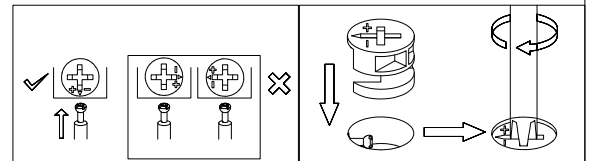

	Bx7pcs
	Cx3pcs

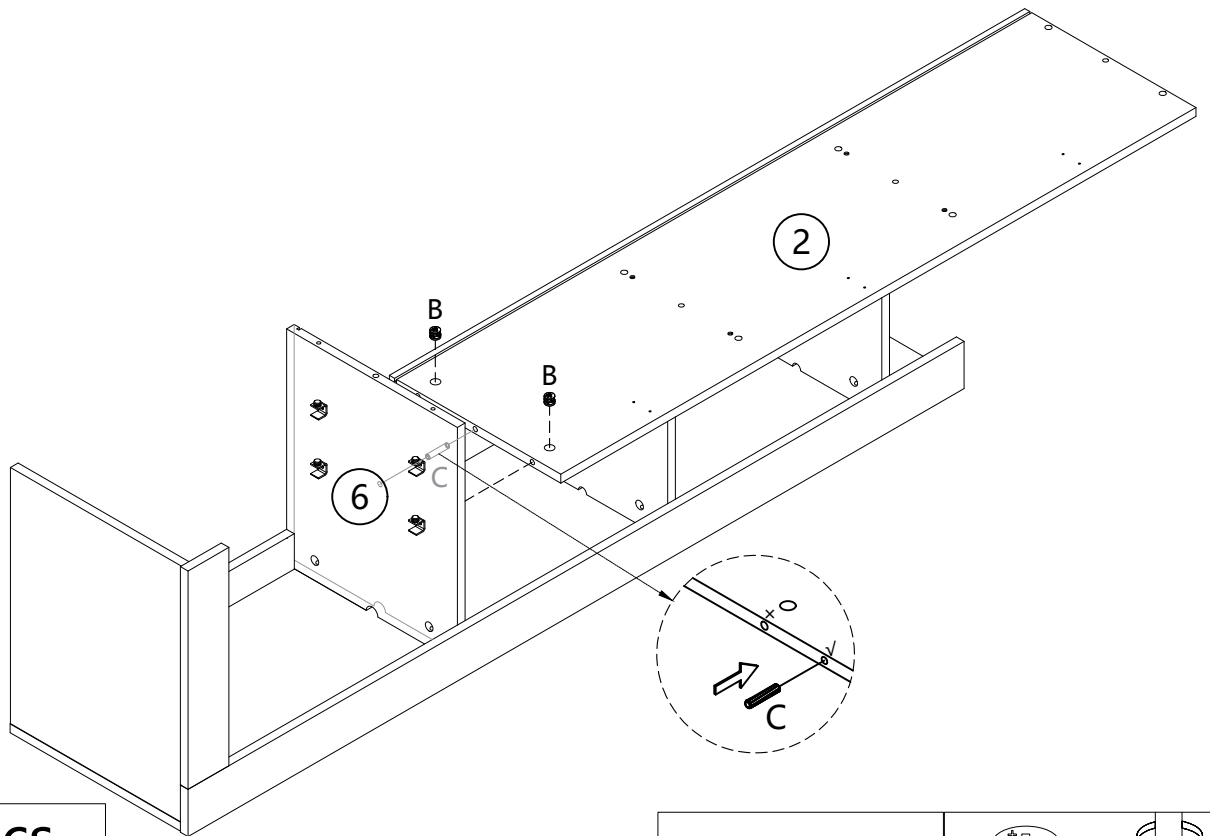

# 12



	Bx2pcs
	Cx1pc

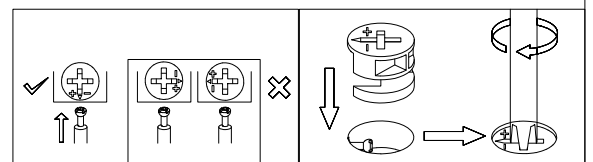

# 13

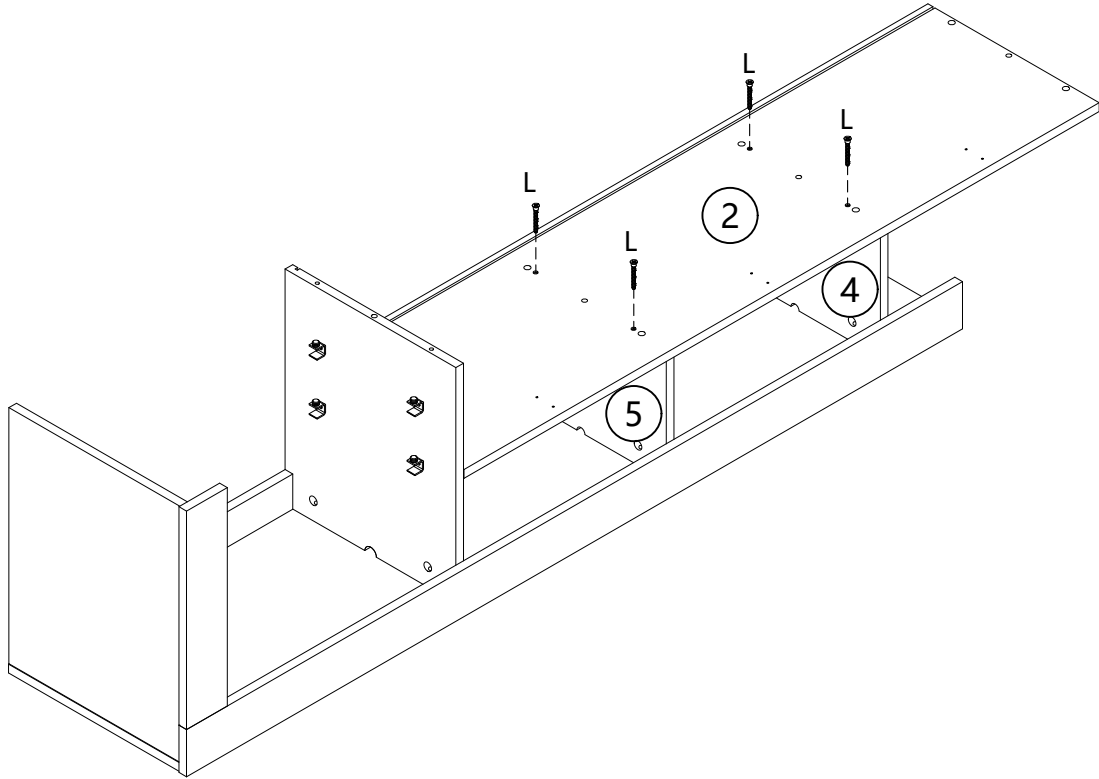

Lx4pcs

# 14

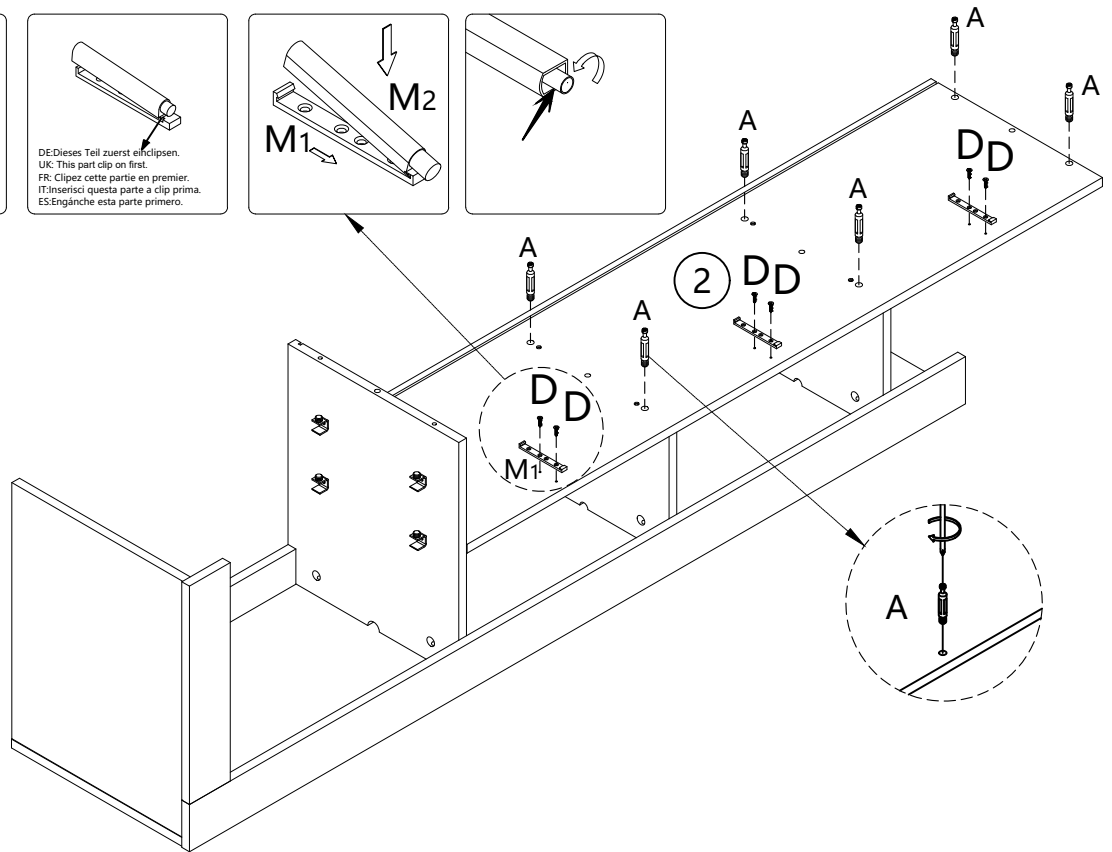
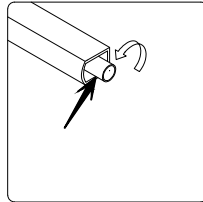
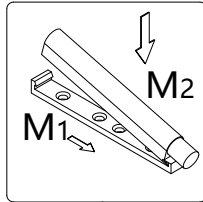
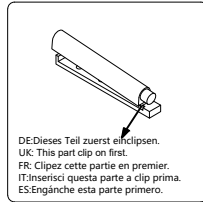
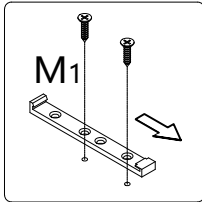

Ax6pcs



Dx6pcs



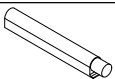

M<sub>1</sub>x3pcs



M<sub>2</sub>x3pcs

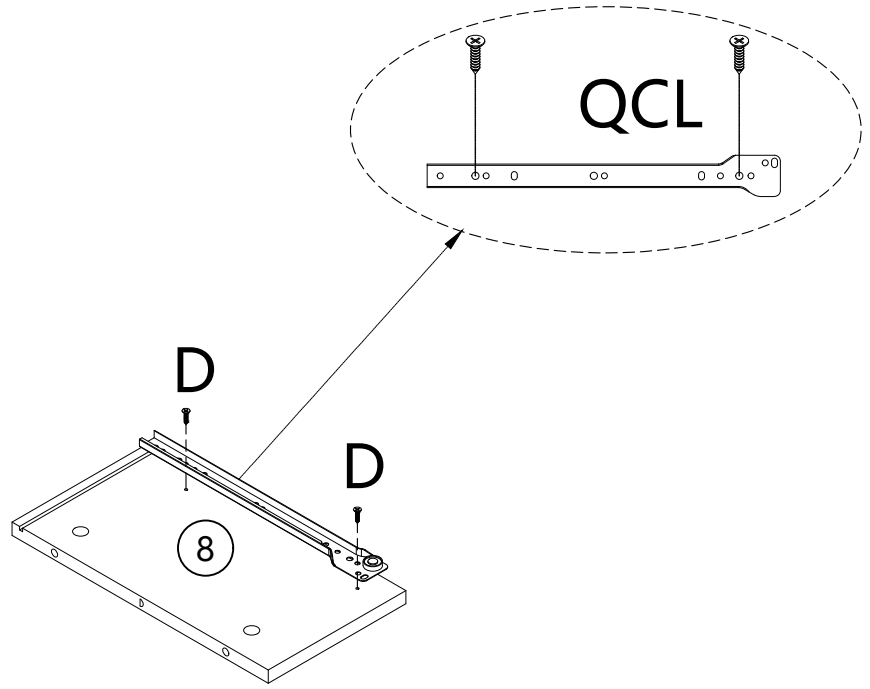

15



	Dx2pcs
	QCLx1pc

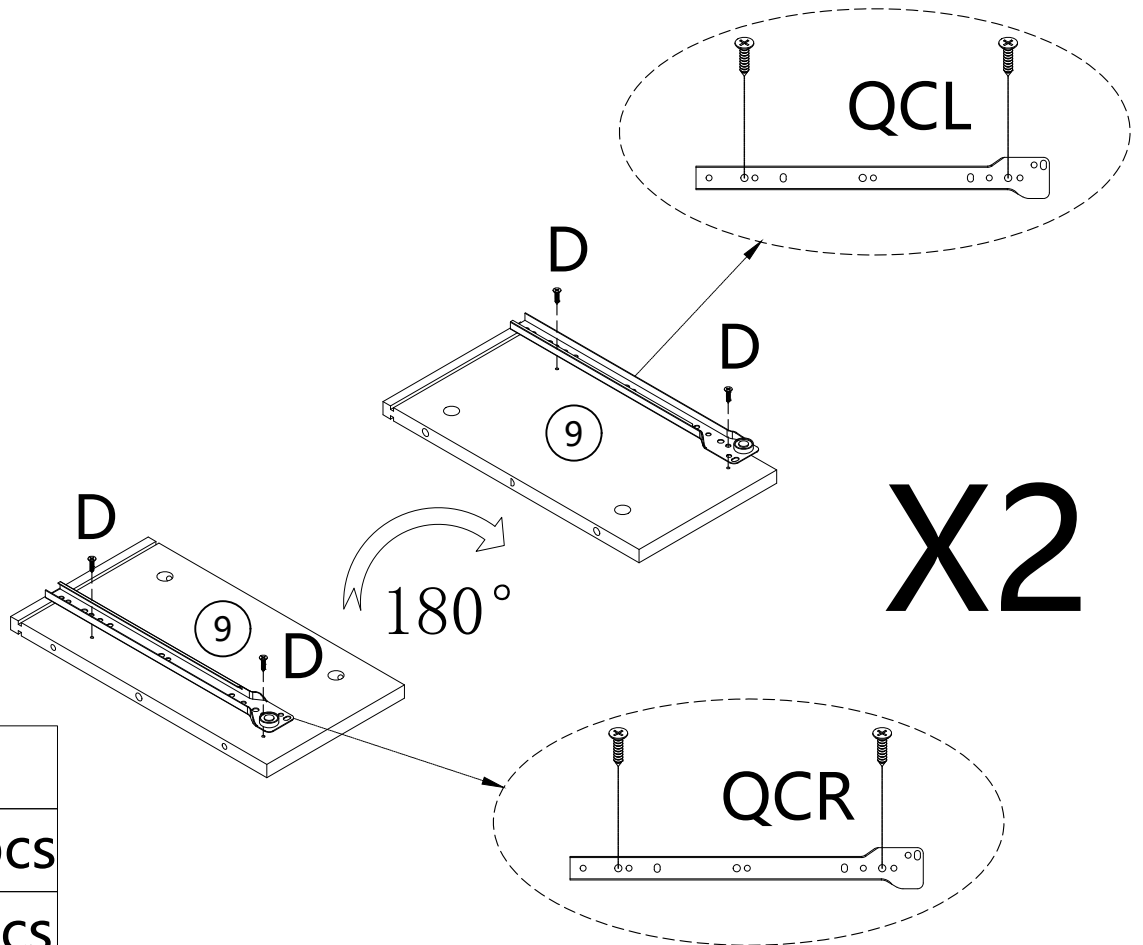

16

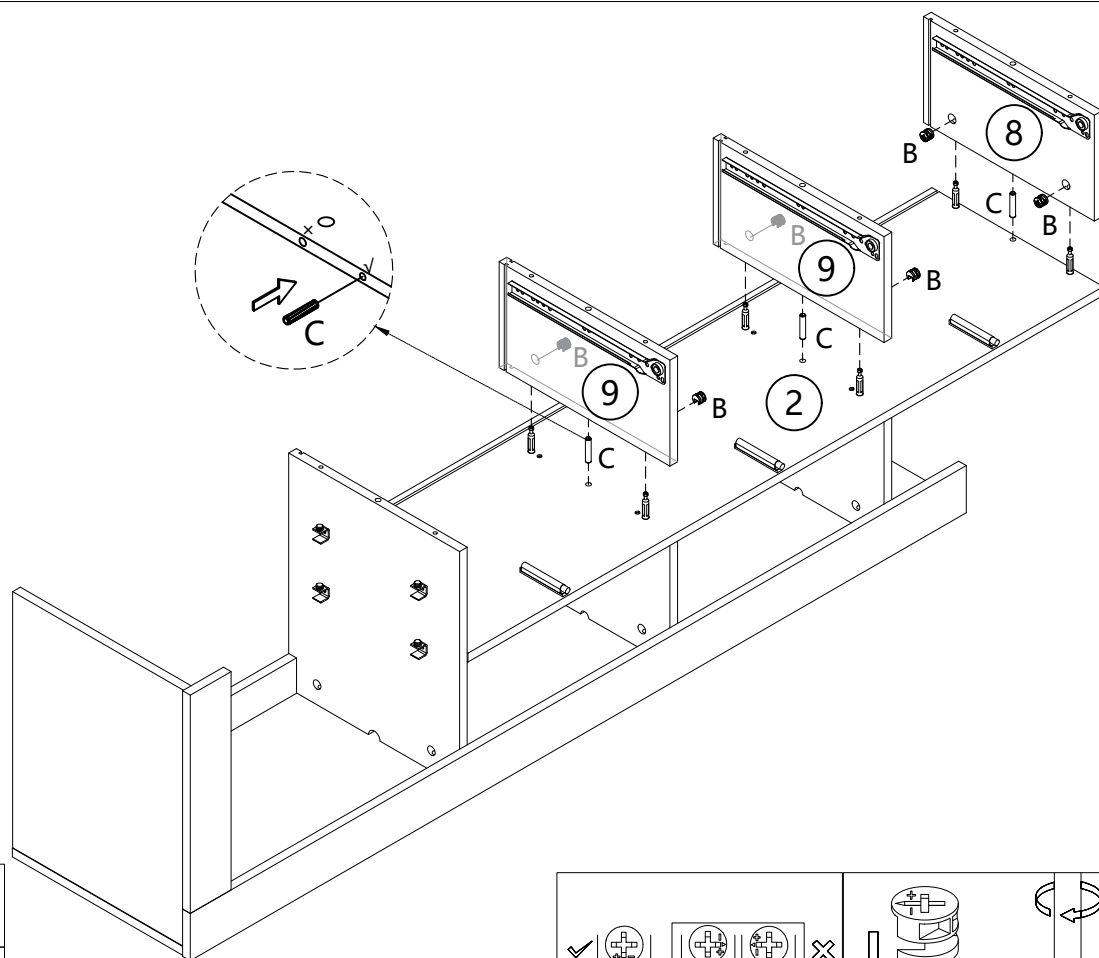

	Dx8pcs
	QCRx2pcs
	QCLx2pcs

# 17



	Bx6pcs
	Cx3pcs

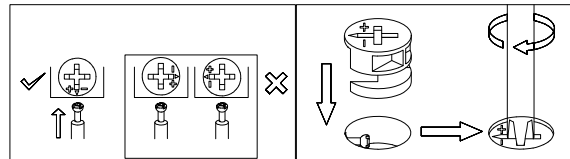

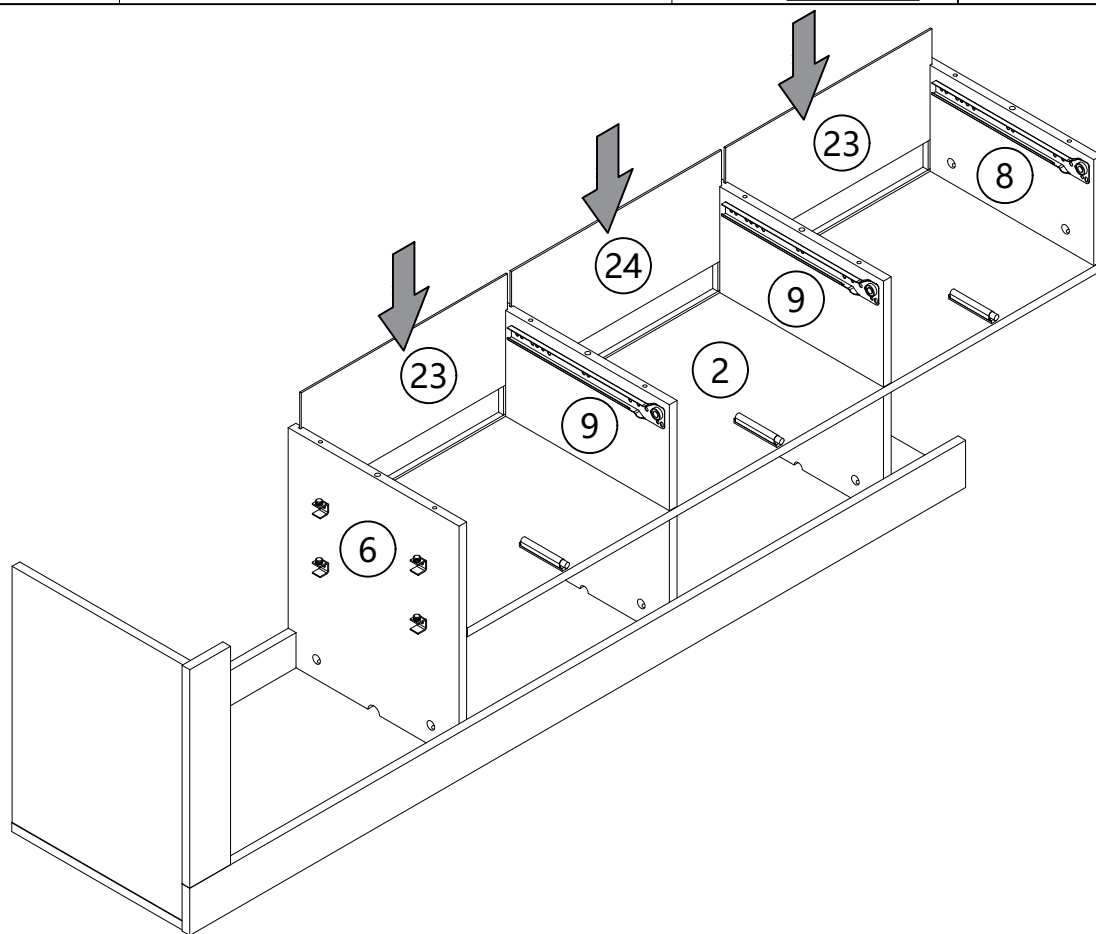

# 18



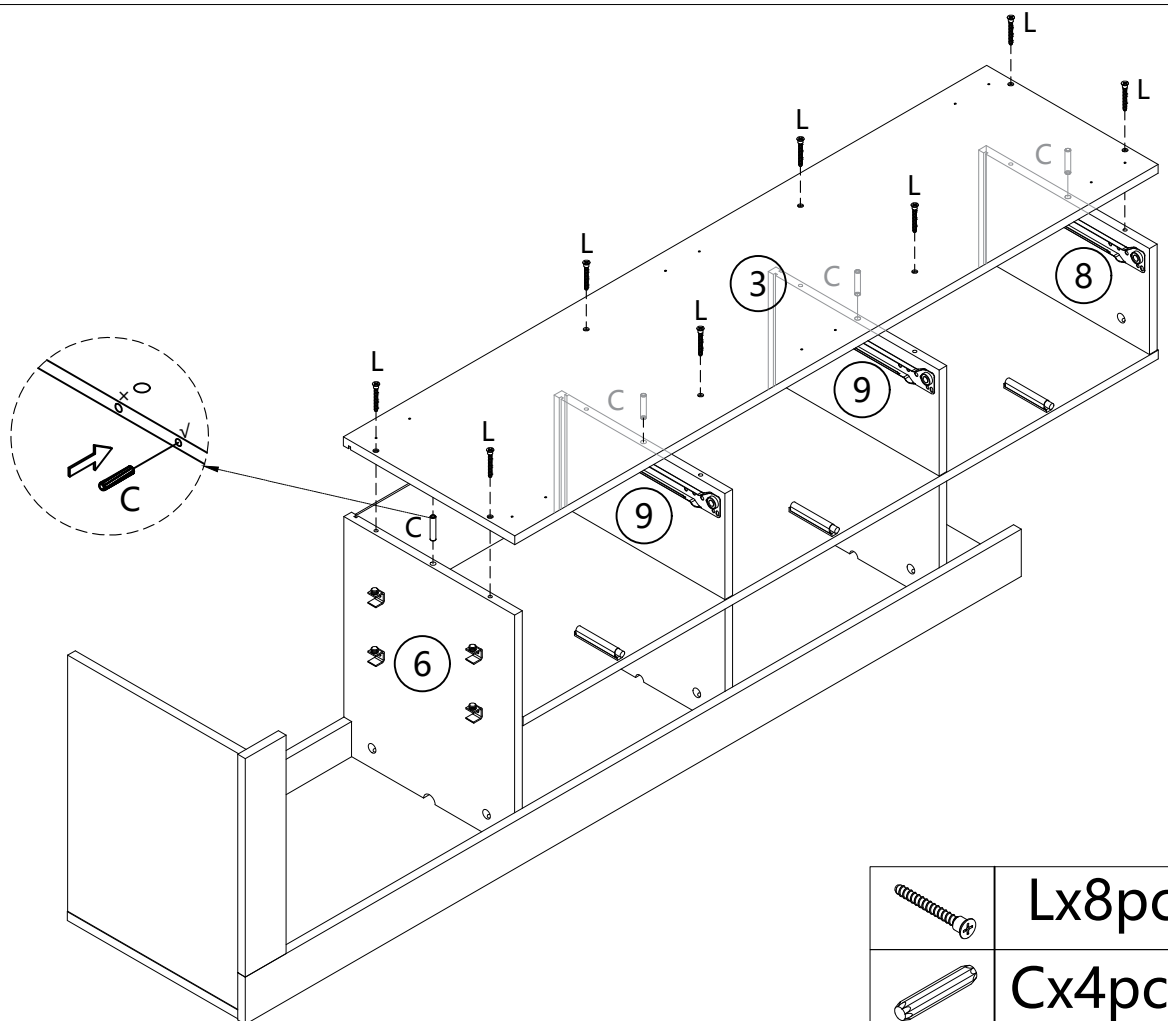

# 19



	Lx8pcs
	Cx4pcs

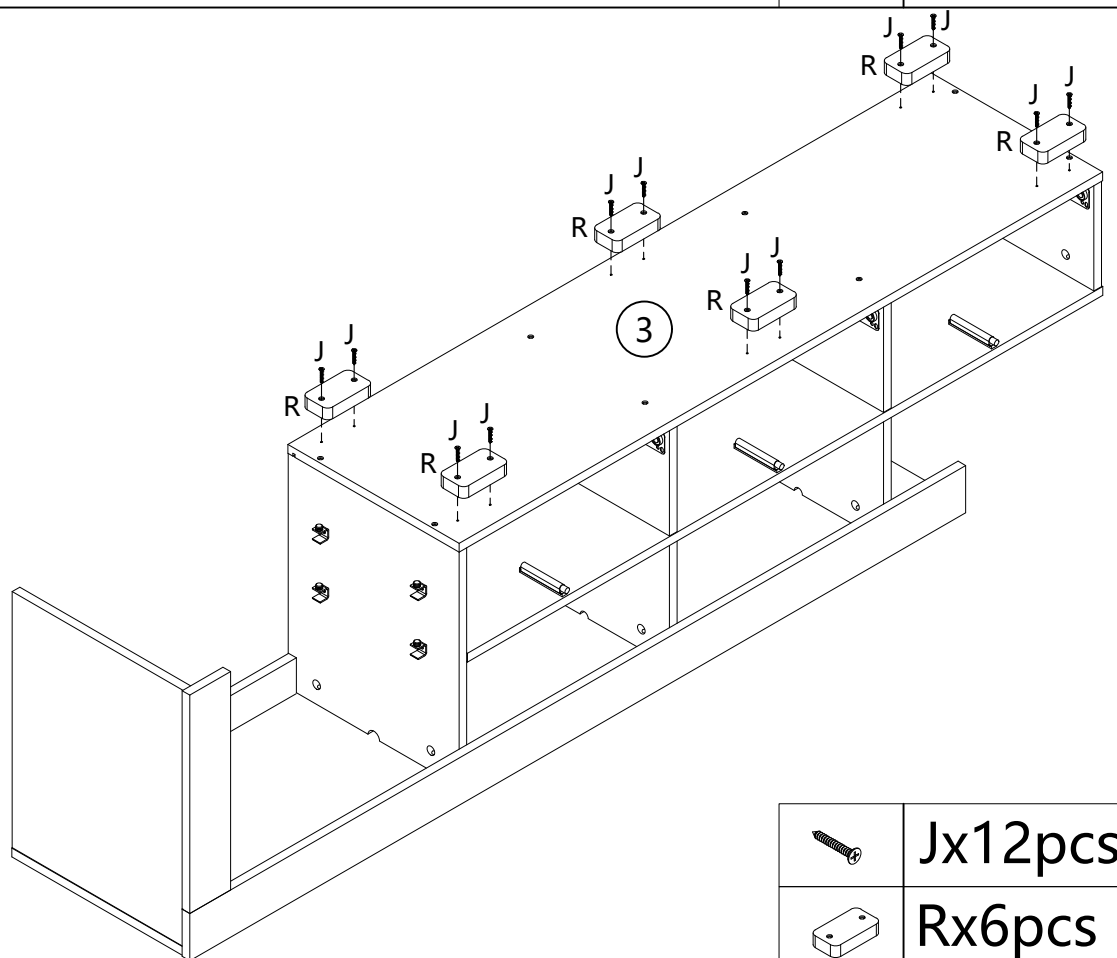

# 20

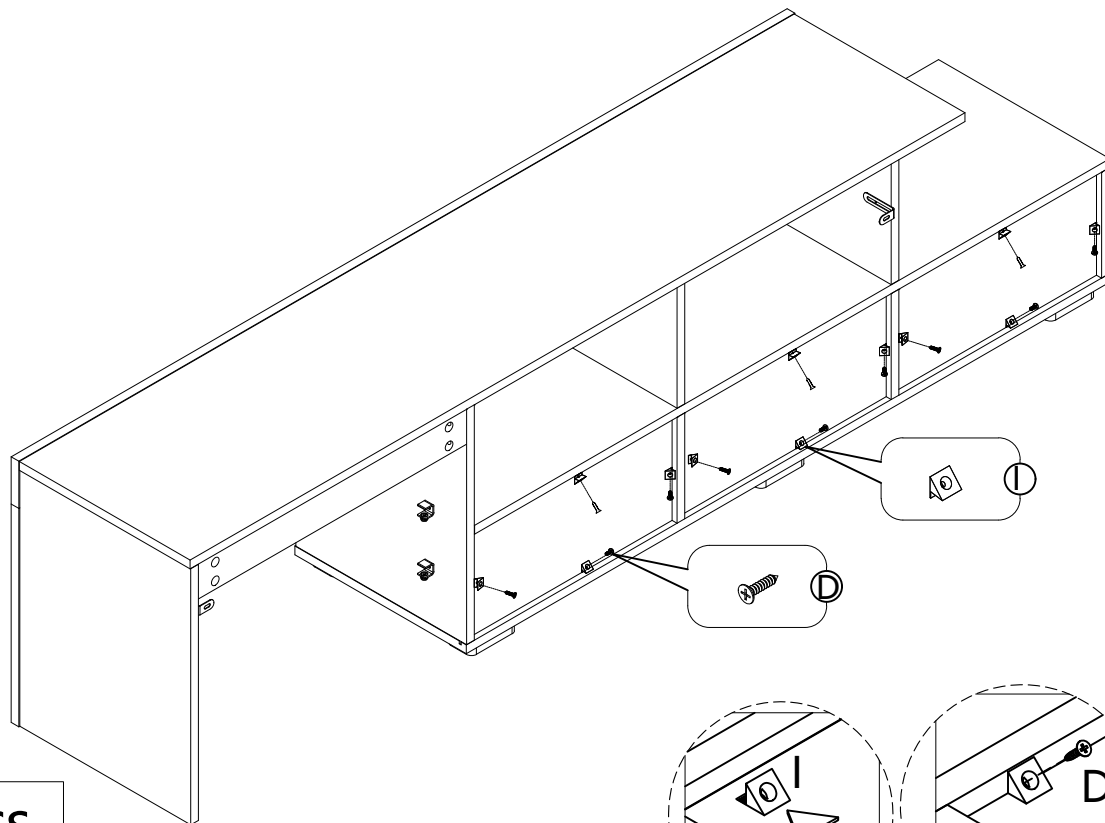

	Jx12pcs
	Rx6pcs

# 21



	Dx12pcs
	Ix12pcs

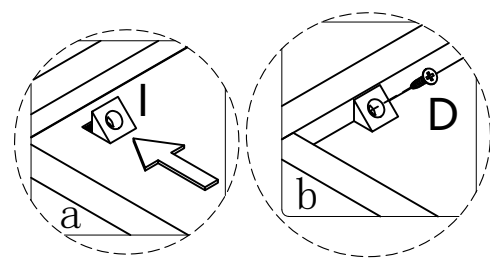

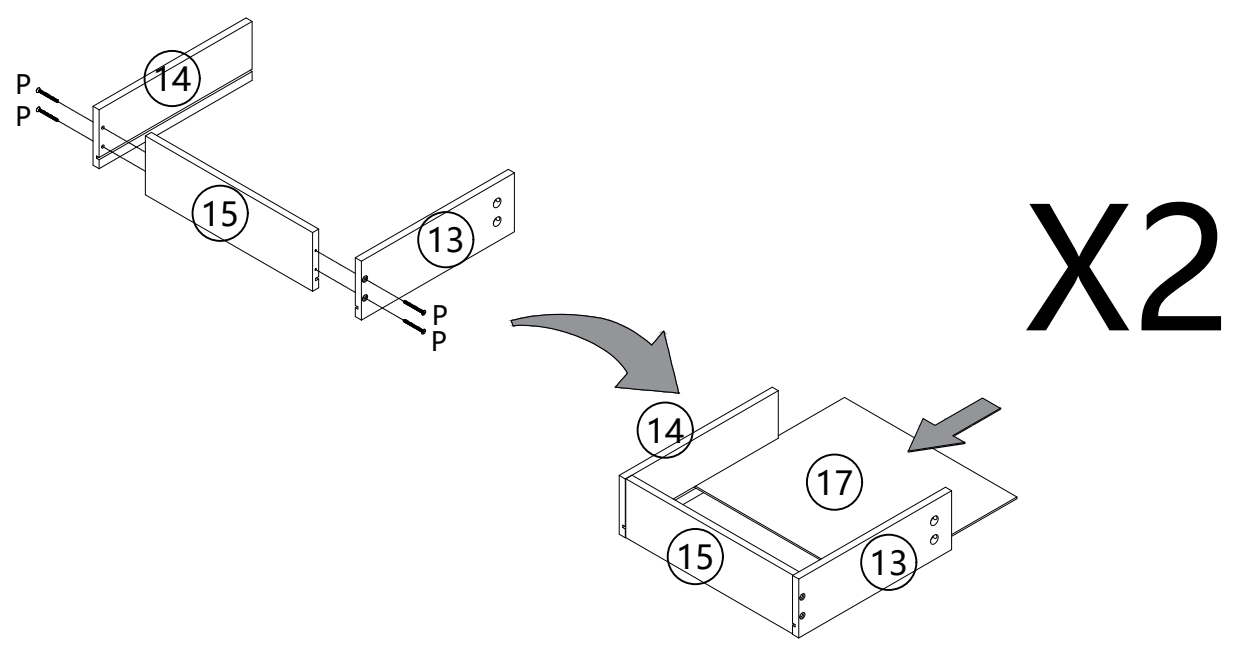

# 22

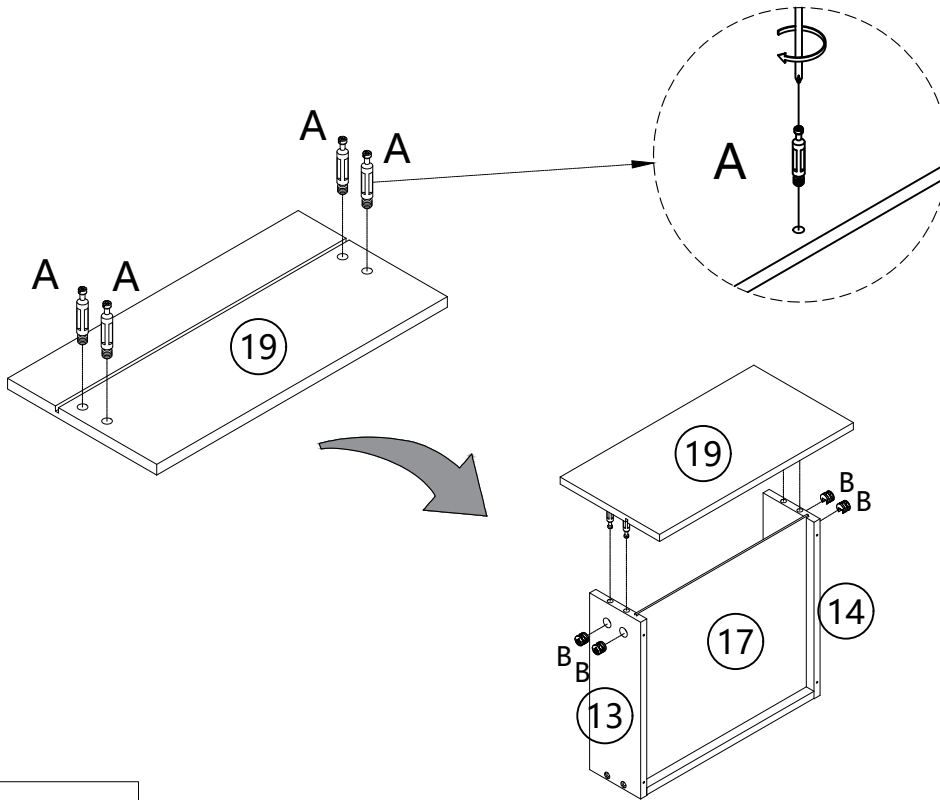

	Px8pcs
--	--------

# 23



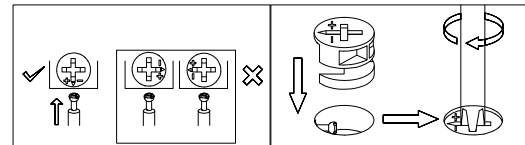

	Ax4pcs
	Bx4pcs



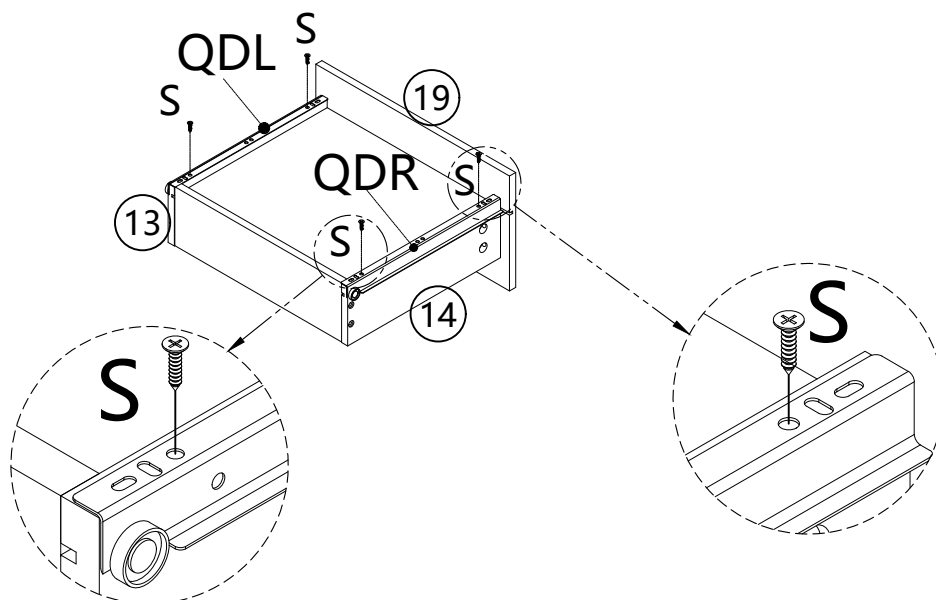

# 24

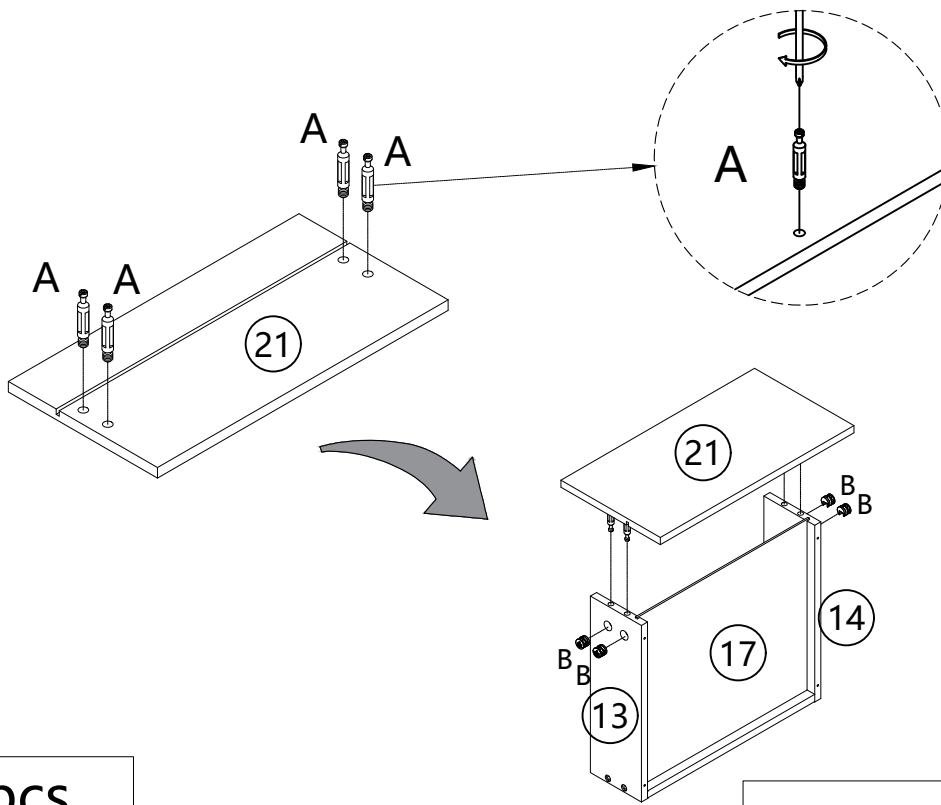

	Sx4pcs
	QDRx1pc
	QDLx1pc

# 25



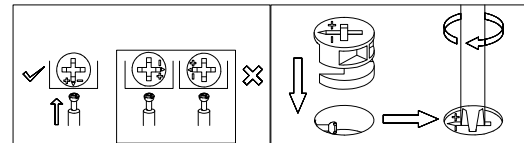

	Ax4pcs
	Bx4pcs

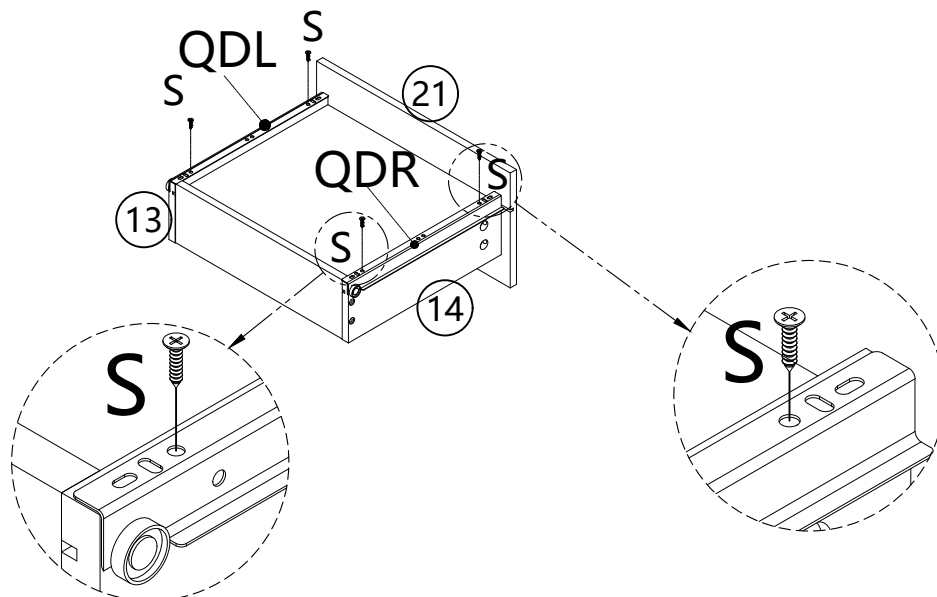

# 26





	Sx4pcs
	QDRx1pc
	QDLx1pc

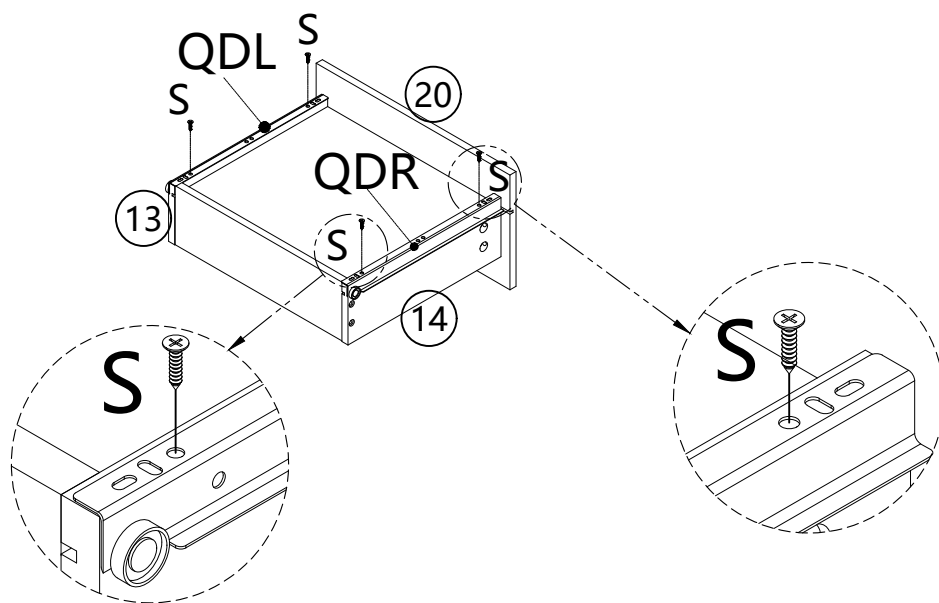

# 29



	Sx4pcs
	QDRx1pc
	QDLx1pc

# 30

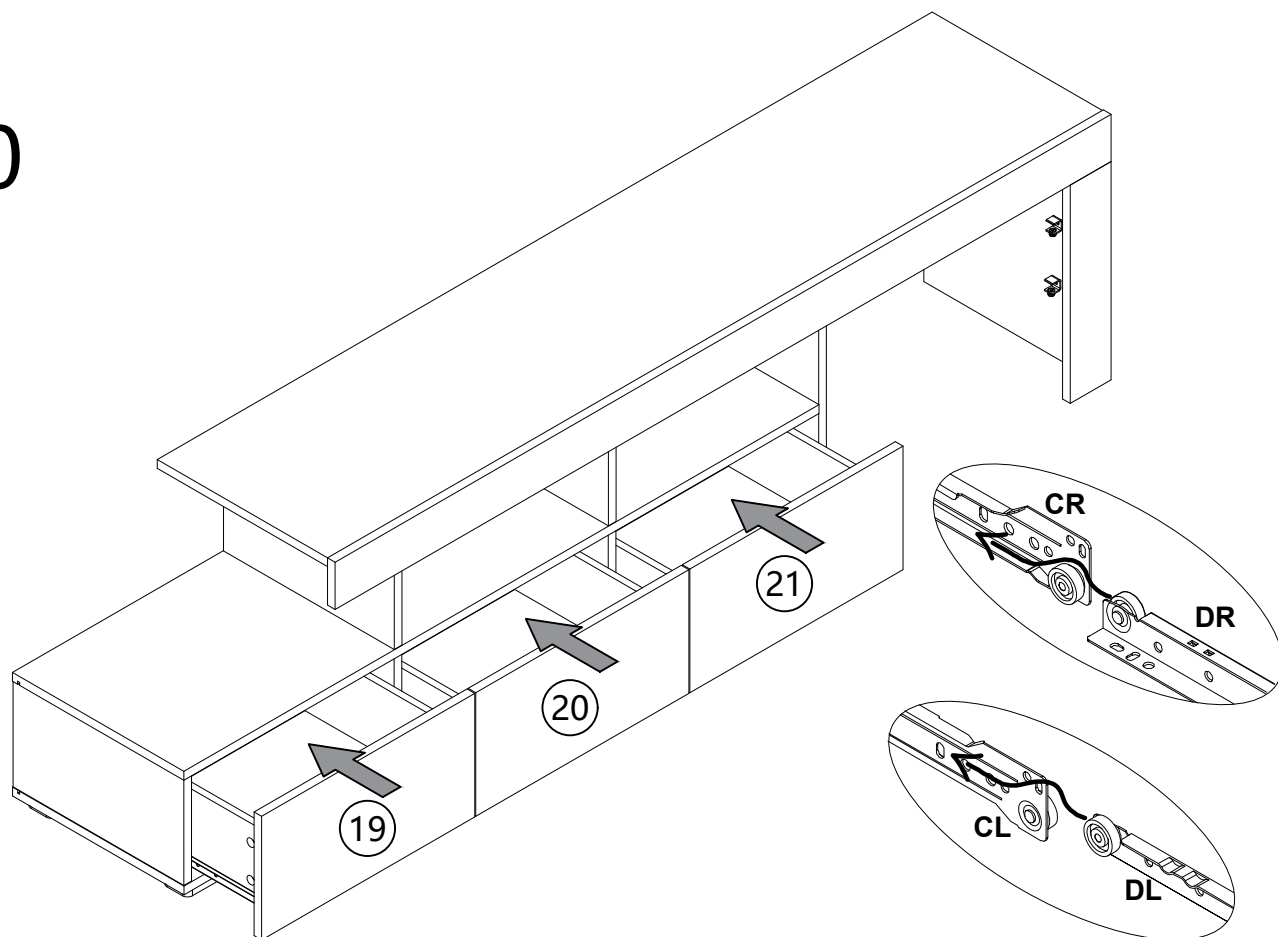

31

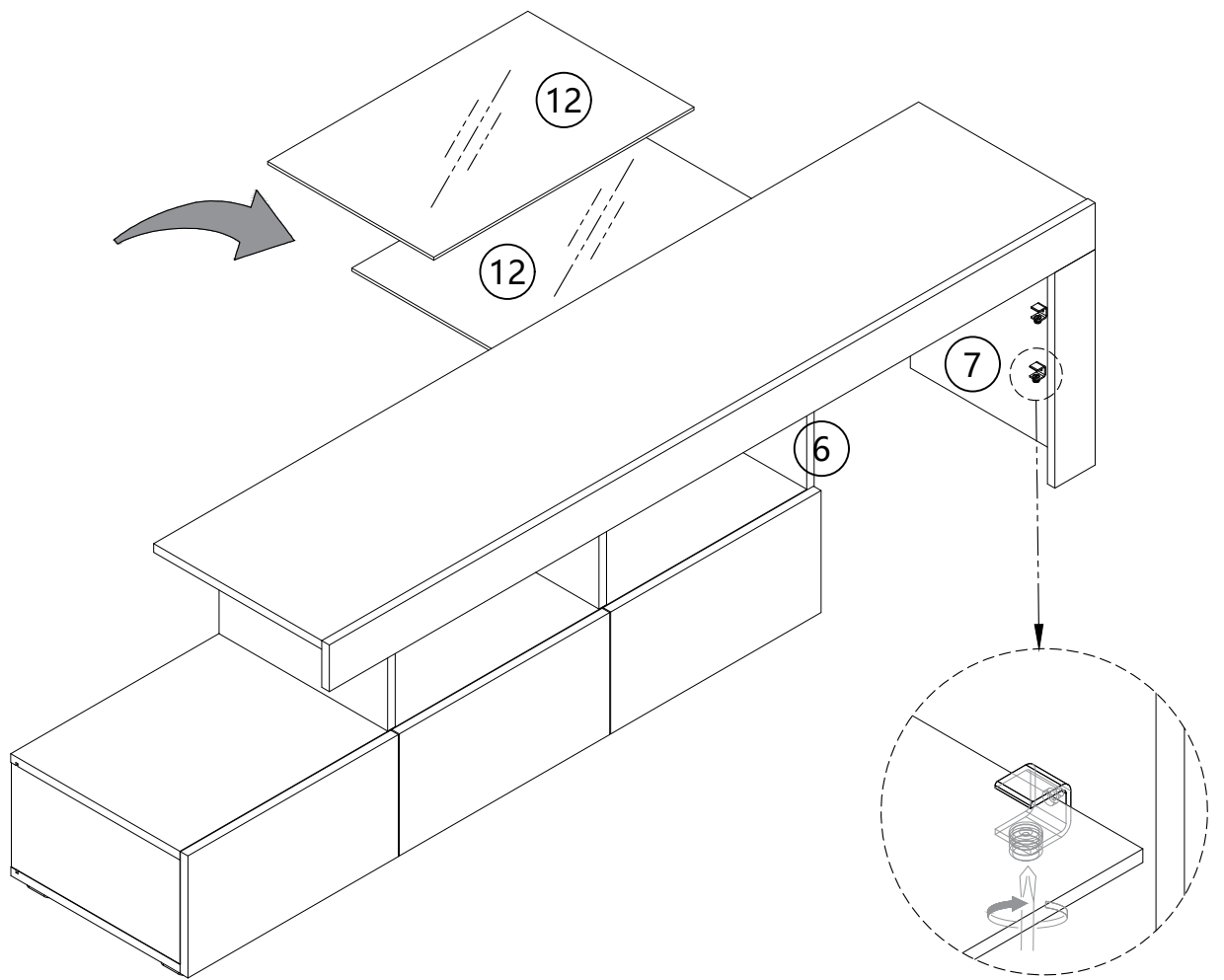

32

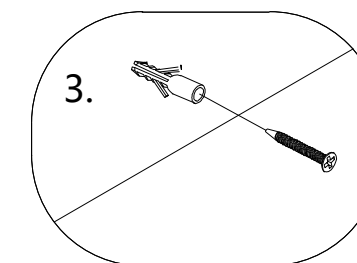
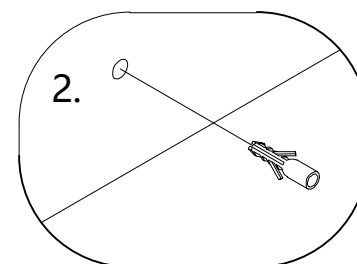
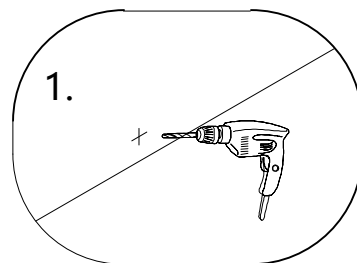
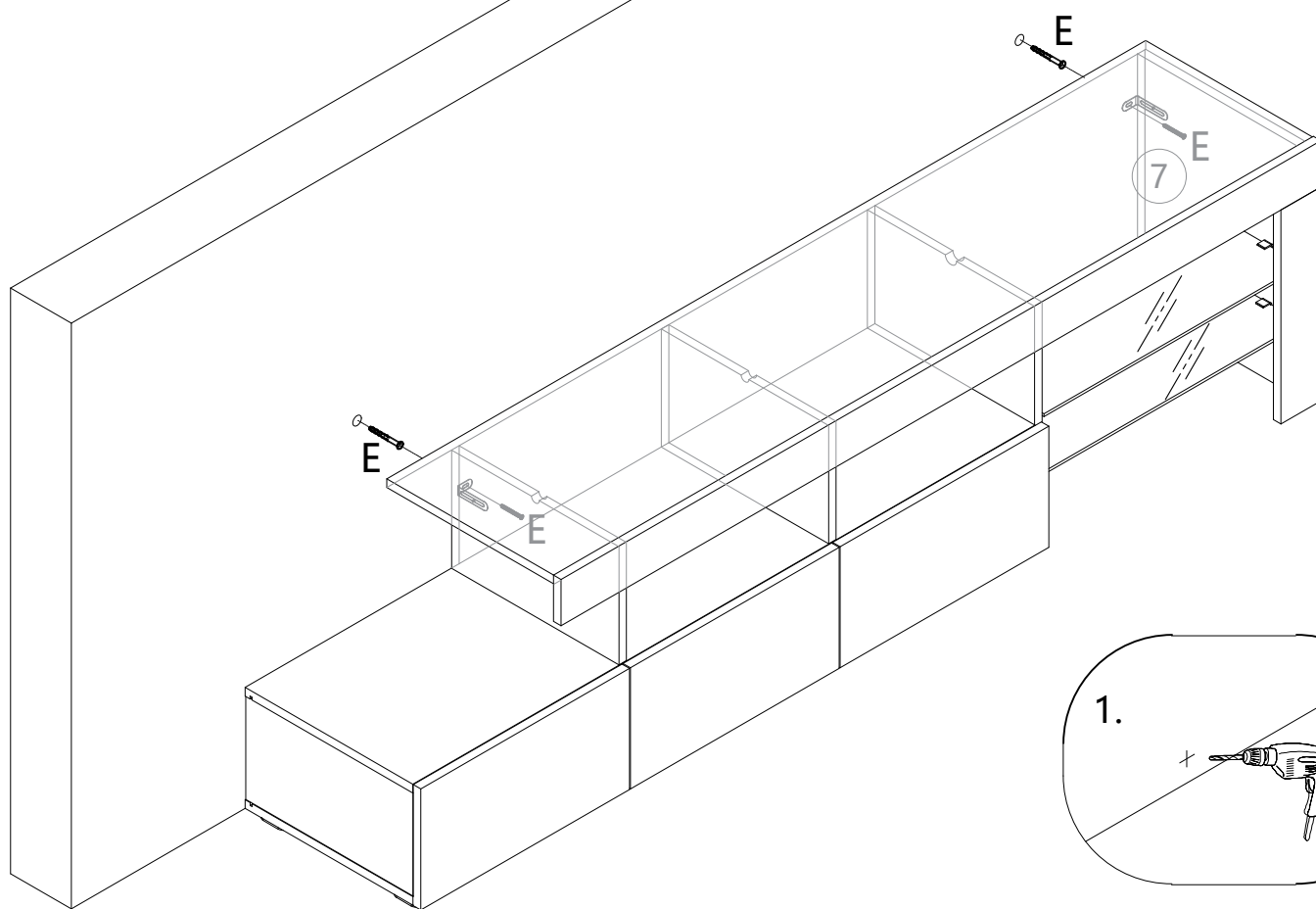

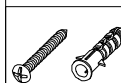
 Ex2pcs

# 33

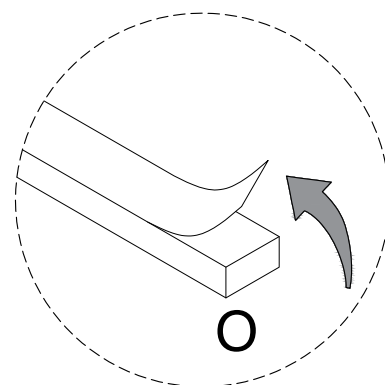
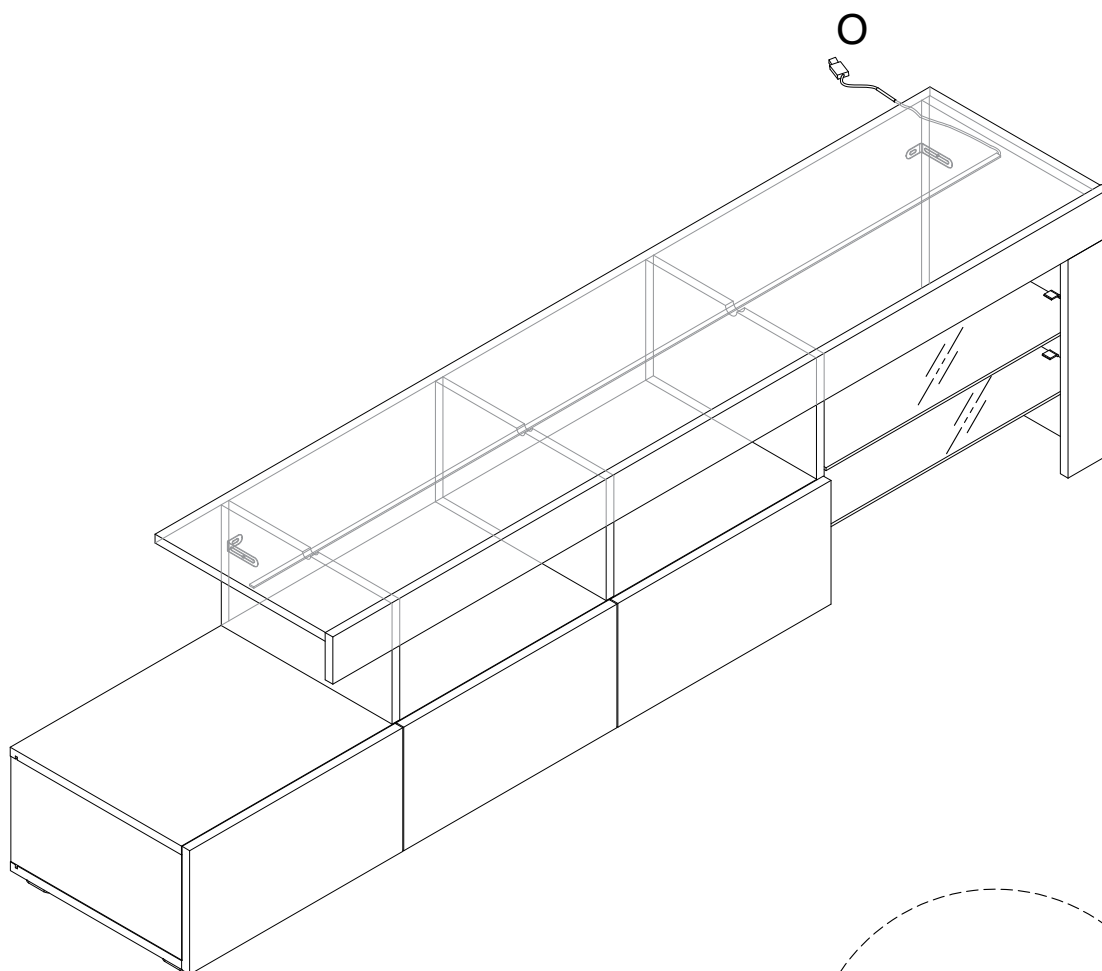

Happy Lighting  
User Manual



DE:Scannen Sie den QR-Code,um die App zur Steuerung des LED-Lichts herunterzuladen.  
EN:Scan the QR code to download the app to control the LED light.  
IT:Scansiona il codice QR per scaricare l'app per controllare la luce LED.  
FR:Scannez le code QR pour telecharger l'application afin de contr?ler la lumiere LED.  
ES:Escanea el codigo QR para descargar la aplicacion y controlar la luz LED.

Scan the QR-Code to download the APP



## Ox1pc

34

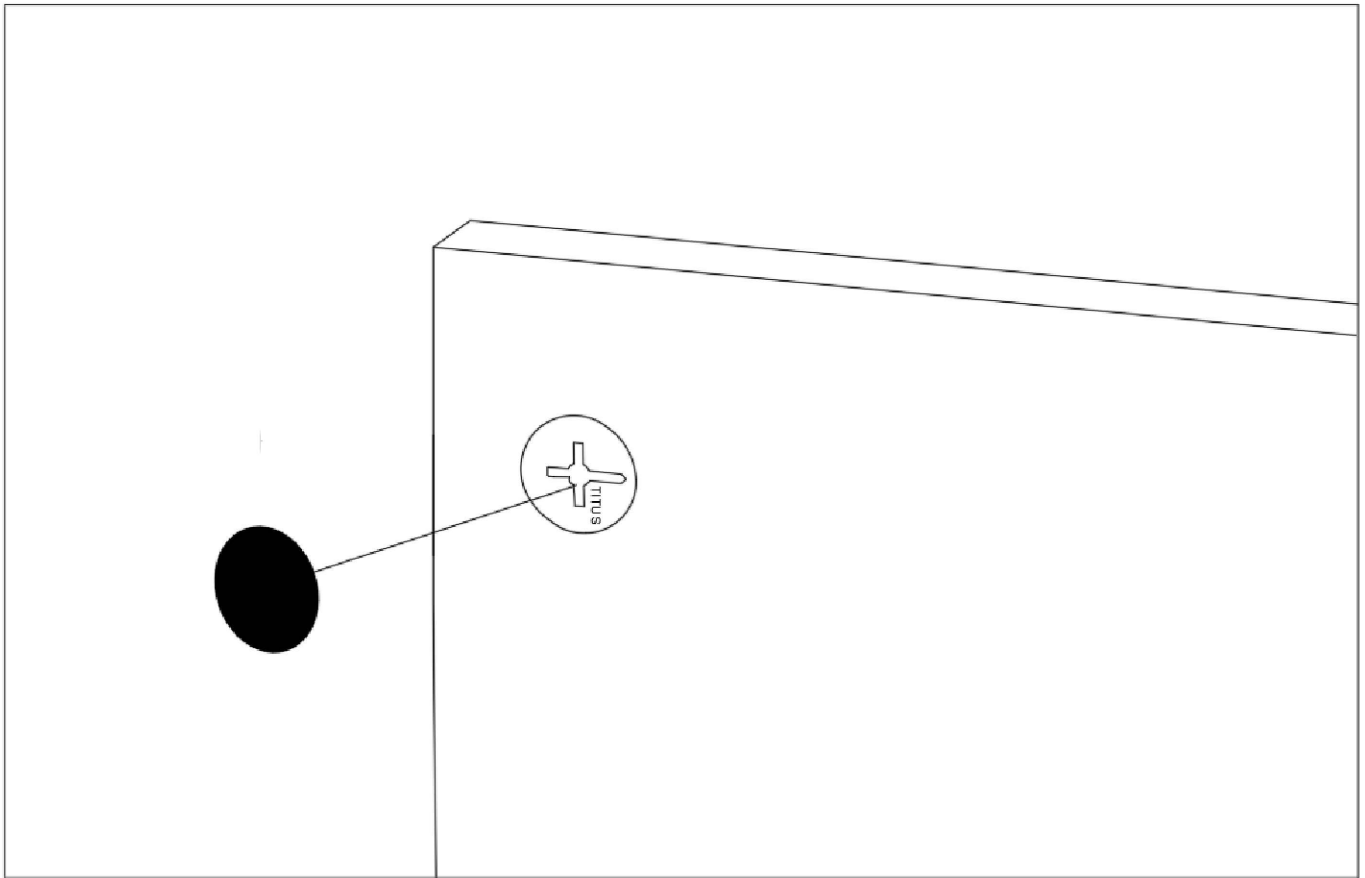

DE:Nach der Installation des Produkts kleben Sie die Nummer K auf die perforierte Position

UK: After installing the product, stick the number K on the perforated position

FR: Une fois le produit installé, collez le numéro K à l'endroit où il y a des trous

IT:Dopo l'installazione del prodotto, attaccare il numero K La posizione perforata

ES:Después de instalar el producto, pegue el número K La posición perforada

 Kx52pcs

35

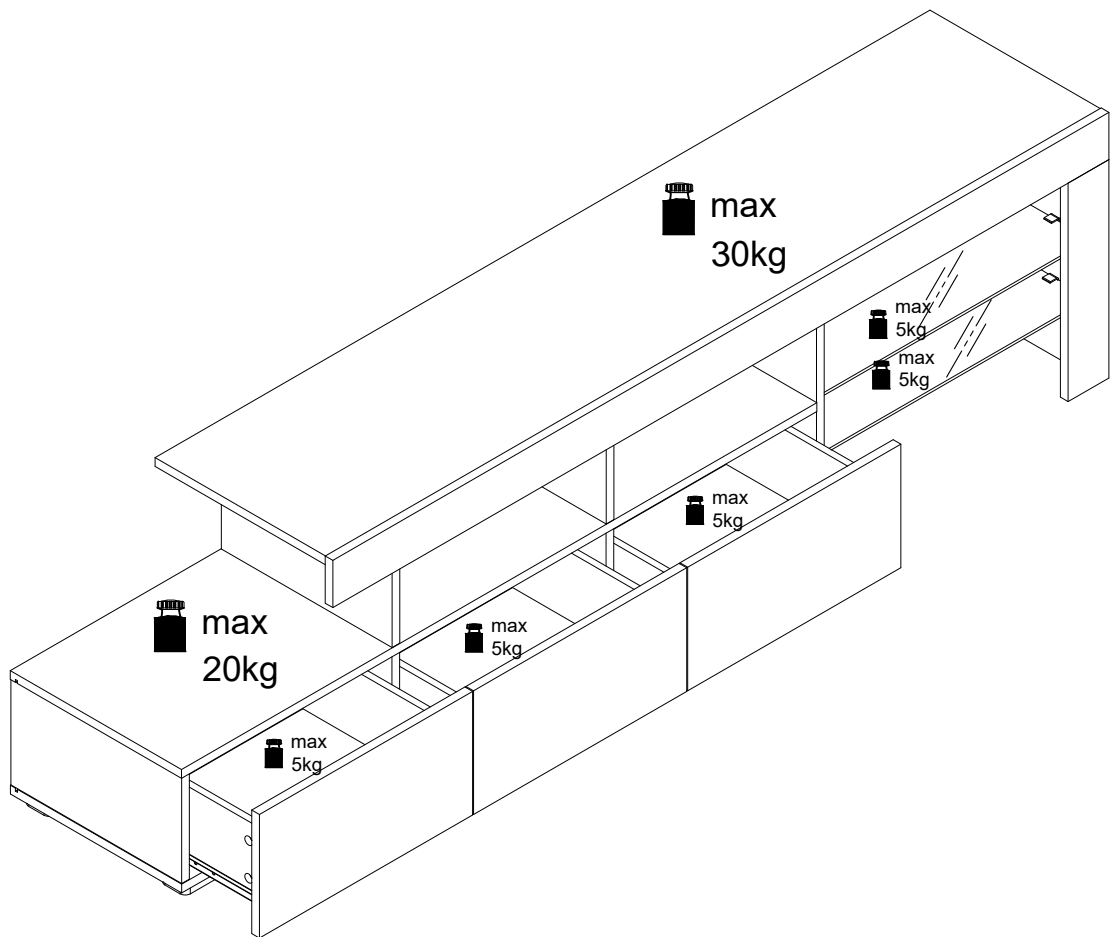

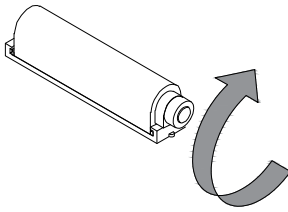

DE: Wenn die Schublade/Tür mit Auslöser (Teil: **19,20,21**) nach außen vorsteht, drehen Sie den Auslöser im Uhrzeigersinn, bis er sanft die Innenseite der Front berührt

FR: Si le tiroir/porte avec loquet (Pièce : **19,20,21**) dépasse vers l'extérieur, tournez le loquet dans le sens horaire jusqu'à ce qu'il touche légèrement l'intérieur du panneau.

EN: If the drawer/door with push-latch (Part: **19,20,21**) protrudes outward rotate the latch clockwise until it gently touches the inner side of the panel

IT: Se la cassetta/porta con dispositivo (Parte: **19,20,21**) sporge verso l'esterno, ruotare il dispositivo in senso orario finché non tocca leggermente la parte interna del pannello

ES: Si el cajón/puerta con mecanismo de retroceso (Pieza: **19,20,21**), sobresale hacia afuera, gire el mecanismo en sentido horario hasta que toque suavemente el interior del panel.

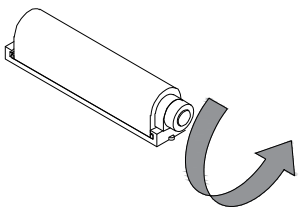

DE: Wenn die Schublade/Tür mit Auslöser (Teil: **19,20,21**) nach innen versenkt ist, drehen Sie den Auslöser gegen den Uhrzeigersinn, bis er sanft die Innenseite der Front berührt.

FR: Si le tiroir/porte avec loquet (Pièce : **19,20,21**) est enfoncé vers l'intérieur, tournez le loquet dans le sens antihoraire jusqu'à ce qu'il touche légèrement l'intérieur du panneau.

EN: If the drawer/door with push-latch (Part: **19,20,21**) is recessed inward, rotate the latch counterclockwise until it gently touches the inner side of the panel

IT: Se la cassetta/porta con dispositivo (Parte: **19,20,21**) è rientrato verso l'interno, ruotare il dispositivo in senso antiorario finché non tocca leggermente la parte interna del pannello

ES: Si el cajón/puerta con mecanismo de retroceso (Pieza: **19,20,21**) está hundido hacia adentro, gire el mecanismo en sentido antihorario hasta que toque suavemente el interior del panel.

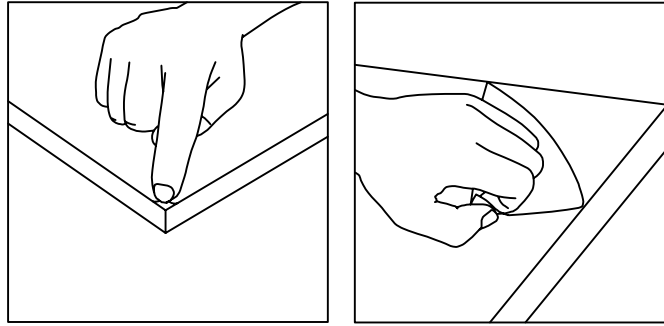

[DE]

**BITTE BEACHTEN:** Teilenummer 10.11.19.20.21 ist mit einer dichten Kunststoffschutzfolie überzogen. Wenn das Produkt nach der Demontage Kratzer aufweist, machen Sie sich bitte keine Sorgen, es handelt sich nicht um einen Produktschaden. Bitte ziehen Sie die schützende Kunststoffolie langsam entlang der Kante von der Oberfläche ab. Nach dem Abziehen wird das Produkt glatt und sauber.

[EN]

**PLEASE NOTE:** Part number 10.11.19.20.21 are covered with a tight plastic protective film. If there are scratches on the product after disassembly, please don't worry, it's not product damage. Please slowly tear off the protective plastic film on the surface along the edge. After peeling off, the product becomes smooth and clean.

[FR]

**REMARQUE :** les pièces numéro 10.11.19.20.21 sont recouvertes d'un film protecteur en plastique étanche. Si le produit présente des rayures après le démontage, ne vous inquiétez pas, il ne s'agit pas d'un dommage au produit. Retirez lentement le film protecteur en plastique sur la surface le long du bord. Une fois décollé, le produit devient lisse et propre.

[IT]

**NOTA BENE:** il numero di parte 10.11.19.20.21 è coperto da una pellicola protettiva in plastica stretta. Se ci sono graffi sul prodotto dopo lo smontaggio, non preoccuparti, non è un danno al prodotto. Strappare lentamente la pellicola protettiva in plastica sulla superficie lungo il bordo. Dopo averla staccata, il prodotto diventa liscio e pulito.

[ES]

**NOTA:** La pieza número 10.11.19.20.21 está cubierta con una película protectora de plástico. Si hay rayones en el producto después de desmontarlo, no se preocupe, no se trata de daños en el producto. Retire lentamente la película protectora de plástico de la superficie a lo largo del borde. Después de despegarla, el producto quedará liso y limpio.

## APP-PROGRAMMANWENDUNG

Klicken, um  
Lampenliste  
anzuzeigen  
Farbrad  
wechseln

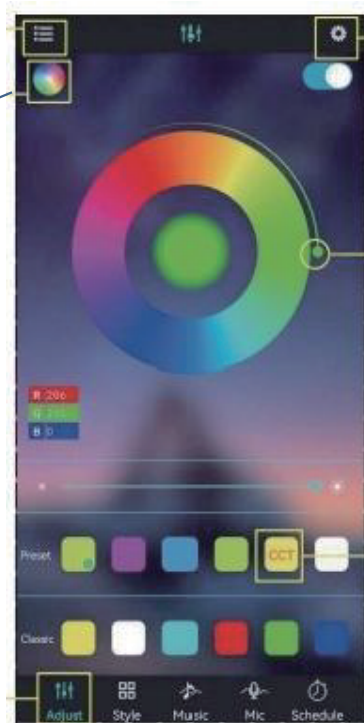

Klicken für  
Einstellungsansicht

Farbe anpassen

Farbanpassung  
per Quadrat-  
Symbol

Schnittstelle  
durch Klicken  
wechseln



## HINWEIS:

Detaillierte Anleitung im  
Menü "Guide"

## PRODUKTPARAMETER

- Bluetooth: BLEVA 2
- Eingangsspannung: 4.5~26V
- Betriebstemperatur: -25~75 °C
- Abmessungen: 43×22×11 mm
- Gewicht: 30g
- Max. Leistung: 144W (24V)

## VERBINDUNGSSCHRITTE

- ① LED-Farbstreifen & Controller verbinden, Controller einschalten
- ② QR-Code scannen zum App-Download:



- ③ App starten, Controller suchen & verbinden
- ④ Bluetooth-Drahtlossteuerung genießen

## PRODUKTMERKMALE

- Direkte Handy-Steuerung (20m Reichweite)
- Automatische Verbindung in 5 Sekunden
- Musikrhythmus-Synchronisation
- Gruppensteuerung
- Helligkeits-/Geschwindigkeitsregelung
- Unterstützt bis 10m RGB(W)-Streifen
- Automatische Sprachumschaltung (DE/EN)

## ANIMATIONSEFFEKTE

- Farbverläufe
- Einfarbige/ Zweifarbig Gradienten
- Monochrome/Bunte Blinkereffekte
- Farbspringen
- Musikresponsive Effekte

## APP PROGRAM USAGE

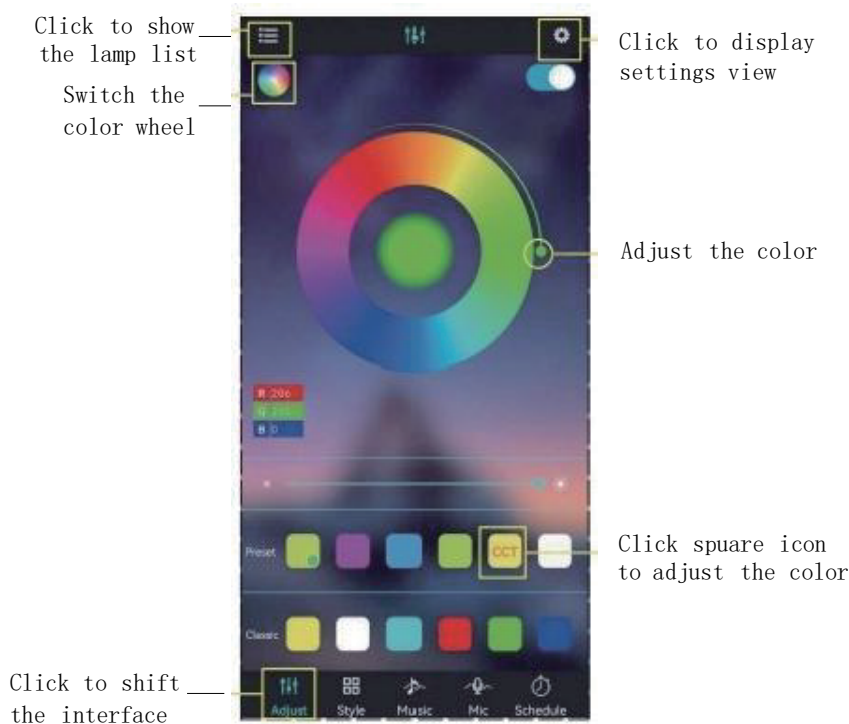

- Scan two-dimensional code download APP
- ①Connect LED color strip and controller, power on controller
  - ②Scan two-dimensional code download APP:



- ③Start APP, search and connect controller
- ④Enjoy the Bluetooth wireless control experience



Notes:  
detailed operating instructions,  
enter the menu "Guide":

Product Paramters:

- Bluetooth:BLEV4.2
- Input Voltage:4.5~26V
- Working Temp:-25~75°C
- Size:43\*22\*11mm
- Weight:30g
- Max Power:144W (24V)

LED mobile phone Bluetooth controllerProduct Features

- LED Bluetooth controller is directly via mobilephone control remote distance can reach 20m without the need to setupeasy to connect open the software within 5 seconds you can automatically connect the controller
- Flow the rhythm of the music changes
- Group control
- Brightness, speed addition and subtraction
- Maximum can be 10 meters RGB(W) strip
- The software shows that the text is based onthe language of the mobile phone set up automatic transformation of Chinese and English

ANIMATION EFFECTS:

- Colorful gradient
- All kinds of monochrome, double color gradient
- All kinds of monochrome, double color, colorfull flashing
- Colorful jump
- Follow the thymhm of the music chagnes

## APP-PROGRAMMANWENDUNG

Afficher la  
liste des lampes  
Farbrad  
Changer la  
Roue chromatique

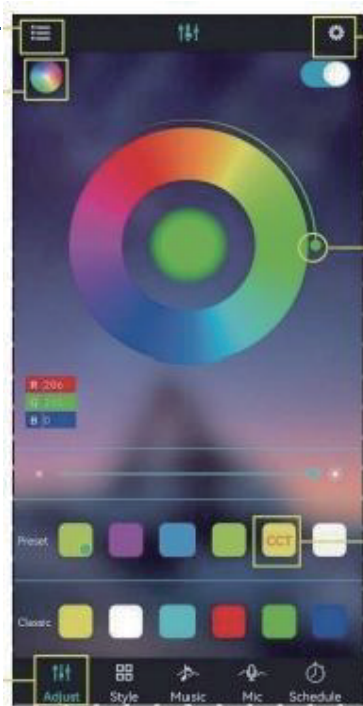

Afficher les  
paramètres

Ajuster la couleur

Cliquez sur l'icône  
carrée pour ajuster  
la couleur.

Changer d'  
interface  
par clic



### REMARQUE :

Guide détaillé dans le menu  
"Guide"

### CARACTÉRISTIQUES

- Bluetooth : BLEVA 2
- Tension d'entrée : 4.5~26V
- Température : -25~75° C
- Dimensions : 43×22×11 mm
- Poids : 30g
- Puissance max : 144W (24V)

## ÉTAPES DE CONNEXION

- ① Connecter bande LED & contrôleur, allumer
- ② Scanner QR code pour télécharger l'app :



- ③ Lancer l'app, rechercher & connecter
- ④ Profiter du contrôle Bluetooth sans fil

## FONCTIONNALITÉS

- Contrôle direct par smartphone (20m)
- Connexion automatique en 5 secondes
- Synchronisation musicale
- Contrôle de groupe
- Réglage luminosité/vitesse
- Prise en charge bandes ≤10m RGB(W)
- Basculement automatique FR/EN

## EFFETS D'ANIMATION

- Dégradés de couleurs
- Dégradés uni/bicolores
- Clignotements mono/colorés
- Saut de couleurs
- Effets réactifs à la musique

## UTILIZZO APP



## PASSI CONNESSIONE

- ① Collega striscia LED & controller, accendi
- ② Scansiona QR code per scaricare APP:



- ③ Avvia APP, cerca & connetti controller
- ④ Goditi controllo wireless Bluetooth



## NOTA:

Guida completa nel menu "Guide"

## SPECIFICHE:

- Bluetooth: BLEVA 2
- Tensione ingresso: 4.5~26V
- Temperatura: -25~75° C
- Dimensioni: 43×22×11 mm
- Peso: 30g
- Potenza max: 144W (24V)

## CARATTERISTICHE

- Controllo diretto smartphone (20m)
- Connessione automatica in 5 secondi
- Sincronizzazione ritmo musicale
- Controllo di gruppo
- Regolazione luminosità/velocità
- Supporto strisce ≤10m RGB(W)
- Auto switch IT/EN

## EFFETTI ANIMAZIONE:

- Sfumature colore
- Gradienti mono/bicolori
- Luci lampeggianti mono/colorate
- Salto colori
- Effetti reattivi alla musica

## USO DE LA APLICACIÓN

Mostrar lista de —  
Lámparas  
Cambiar rueda de color

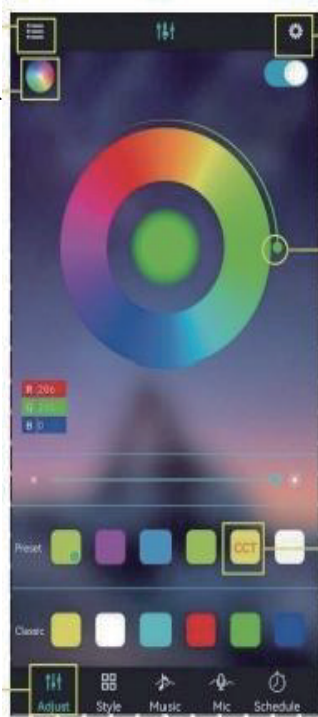

Ver ajustes

Ajustar el color

Clicar para ajustar color  
con icono cuadrado

Cambiar interfaz  
haciendo clic —



NOTA:

Guía completa en menú "Guide"

ESPECIFICACIONES:

- Bluetooth: BLEVA 2
- Voltaje entrada: 4.5~26V
- Temperatura: -25~75° C
- Tamaño: 43×22×11 mm
- Peso: 30g
- Potencia máx: 144W (24V)

## PASOS DE CONEXIÓN

- ① Conectar tira LED y controlador, encender
- ② Escanear QR para descargar APP:



- ③ Iniciar APP, buscar y conectar
- ④ Disfrutar control inalámbrico Bluetooth

## CARACTERÍSTICAS

- Control directo móvil (20m alcance)
- Conexión automática en 5 segundos
- Sincronización ritmo musical
- Control grupal
- Ajuste brillo/velocidad
- Soporte tiras ≤10m RGB(W)
- Auto cambio ES/EN

## EFFECTOS DE ANIMACIÓN:

- Degradados de color
- Transiciones mono/bicolores
- Destellos monocromáticos/color
- Salto de colores
- Efectos reactivos a música



# Certificate of Compliance

Certificate Number: ZHT-250114113C01C

**Applicant Name / Zertifikatsinhaber** : Shenzhen Dengdai Yunlian Lighting Co., Ltd  
**Address / Adresse** : 2nd Floor, Building A, No. 15 Jinkui East Road, Kuiyong Street, Dapeng New District, Shenzhen, Guangdong, China  
**Manufacturer / Hersteller** : Shenzhen Dengdai Yunlian Lighting Co., Ltd  
**Address / Adresse** : 2nd Floor, Building A, No. 15 Jinkui East Road, Kuiyong Street, Dapeng New District, Shenzhen, Guangdong, China  
**Product / Produkt** : CCT led strips  
**Main Model(s) / Hauptmodell(e)** : 2835 CCT-05  
**Additional Model(s) / Zusätzliche(s) Modell(e)** : 2835 CCT-03, 2835 CCT-12, 2835 CCT-24  
**Trade Mark / Warenzeichen** :   
**Test Standard / Geprüft nach** : IEC 62321-3-1:2013, IEC 62321-4:2013+A1:2017, IEC 62321-5:2013, IEC 62321-6:2015, IEC 62321-7-1:2015, IEC 62321-7-2:2017, IEC 62321-8:2017  
**Test Report No./Bericht Nr** : ZHT-250114113C01

The EUT described above has been consolidated by us and found in compliance with the council RoHS Directive 2011/65/EU Annex II amending Annex (EU)2015/863. It is possible to use CE marking to demonstrate the compliance with this RoHS Directive. It is only valid in connection with the test report.

After preparation of the necessary technical documentation according the requirement of EN IEC63000:2018 as well as the verification of conformity the CE marking as shown below can be affixed on the equipment.



The information of the certificate can be checked through [www.zht-lab.cn](http://www.zht-lab.cn).  
The CE mark which is shown on the certificate can only be used under the conditions that the products complete with all of the relevant Directives of EC Declaration of Conformity.  
The Manufacturer should be responsible for the internal production control so that the products complied with the essential requirements of the above mentioned Directive(s). Certificate holder must notify all changes to the original certification laboratory of Guangdong Zhonghan Testing Technology Co., Ltd.



**Guangdong Zhonghan Testing Technology Co., Ltd.**  
**Address:** Room 104/201, Building 1, Yibaolai Industrial Park, Qiaotou, Fuhai Subdistrict, Bao'an District, Shenzhen, Guangdong, China  
**Tel.:** +86-755-27782934 **Http://**[www.zht-lab.cn](http://www.zht-lab.cn) **E-mail:** [admin@zht-lab.cn](mailto:admin@zht-lab.cn)



# Certificate of Compliance

**Certificate Number: ZHT-251124124E01C**

**Certificate's Holder** : Shenzhen Dengdai Yunlian Lighting Co., Ltd  
**Zertifikatsinhaber** : 2nd Floor, Building A, No. 15 Jinkui East Road, Kuiyong Street,  
DapengNew District, Shenzhen, Guangdong, China

**Manufacturer** : Shenzhen Dengdai Yunlian Lighting Co., Ltd  
**Hersteller** : 2nd Floor, Building A, No. 15 Jinkui East Road, Kuiyong Street,  
DapengNew District, Shenzhen, Guangdong, China

**Trade Mark** : VITO  
**Warenzeichen**

**Product** : LED light strip  
**Produkt**

**Model(s)** : 2835 CCT-05  
**Modell** : RGB-05

**Test Standard** : EN IEC 55015:2019+A11:2020  
**Prüfnorm** : EN IEC 61000-3-2:2019 + A1:2021 + A2:2024  
EN 61000-3-3:2013 + A1:2019 + A2:2021  
EN IEC 61547:2023

**Test Report No.** : ZHT-251124124E01  
**Bericht Nr**

This Attestation of Compliance is issued on a voluntary basis for electrical equipment below the voltage limits of EMC Directive 2014/30/EU. The essential requirements are fulfilled accordingly based on the technical specifications applicable at the time of issuance. It is only valid in connection with the test report.

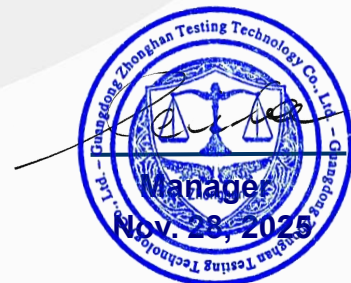

The information of the certificate can be checked through [www.zht-lab.cn](http://www.zht-lab.cn).  
The CE mark which is shown on the certificate can only be used under the conditions that the products complete with all of the relevant Directives of EC Declaration of Conformity.  
The Manufacturer should be responsible for the internal production control so that the products complied with the essential requirements of the above mentioned Directive(s). Certificate holder must notify all changes to the original certification laboratory of Guangdong Zhonghan Testing Technology Co., Ltd.



**Guangdong Zhonghan Testing Technology Co., Ltd.**

**Address:** Room 104/201, Building 1, Yibaolai Industrial Park, Qiaotou, Fuhai Subdistrict, Bao'an District, Shenzhen, Guangdong, China

**Tel.:** +86-755-27782934 **Http://**[www.zht-lab.cn](http://www.zht-lab.cn) **E-mail:** [admin@zht-lab.cn](mailto:admin@zht-lab.cn)



# Certificate of Compliance

**Certificate Number: ZHT-251124124S01C**

**Certificate's Holder** : Shenzhen Dengdai Yunlian Lighting Co., Ltd  
**Zertifikatsinhaber** : 2nd Floor, Building A, No. 15 Jinkui East Road, Kuiyong Street,  
DapengNew District, Shenzhen, Guangdong, China

**Manufacturer** : Shenzhen Dengdai Yunlian Lighting Co., Ltd  
**Hersteller** : 2nd Floor, Building A, No. 15 Jinkui East Road, Kuiyong Street,  
DapengNew District, Shenzhen, Guangdong, China

**Trade Mark** : VITO  
**Warenzeichen**

**Product** : LED light strip  
**Produkt**

**Model(s)** : 2835 CCT-05,  
**Bezeichnung** : RGB-05

**Test Standard** : EN 60598-2-21:2015  
**Geprüft nach** : EN IEC 60598-1:2024+A11:2024  
EN IEC 62031:2020+A11:2021

**Test Report No.** : ZHT-251124124S01  
**Bericht Nr**

This Certificate of Compliance is issued on a voluntary basis for General Product Safety Regulation of directive (EU)2023/988. The essential requirements are fulfilled accordingly based on the technical specifications applicable at the time of issuance. It is only valid in connection with the test report.



The information of the certificate can be checked through [www.zht-lab.cn](http://www.zht-lab.cn).  
The CE mark which is shown on the certificate can only be used under the conditions that the products complete with all of the relevant Directives of EC Declaration of Conformity.  
The Manufacturer should be responsible for the internal production control so that the products complied with the essential requirements of the above mentioned Directive(s). Certificate holder must notify all changes to the original certification laboratory of Guangdong Zhonghan Testing Technology Co., Ltd.



**Guangdong Zhonghan Testing Technology Co., Ltd.**

**Address: Room 104/201, Building 1, Yibaolai Industrial Park, Qiaotou, Fuhai Subdistrict, Bao'an District, Shenzhen, Guangdong, China**

**Tel.: +86-755-27782934** [Http://www.zht-lab.cn](http://www.zht-lab.cn) **E-mail:admin@zht-lab.cn**



# Certificate of Compliance

Certificate Number: ZHT-250114113R01C

**Applicant Name / Zertifikatsinhaber** : Shenzhen Dengdai Yunlian Lighting Co., Ltd  
**Address / Adresse** : 2nd Floor, Building A, No. 15 Jinkui East Road, Kuiyong Street, Dapeng New District, Shenzhen, Guangdong, China  
**Manufacturer / Hersteller** : Shenzhen Dengdai Yunlian Lighting Co., Ltd  
**Address / Adresse** : 2nd Floor, Building A, No. 15 Jinkui East Road, Kuiyong Street, Dapeng New District, Shenzhen, Guangdong, China  
**Product / Produkt** : CCT led strips  
**Main Model(s) / Hauptmodell(e)** : 2835 CCT-05  
**Additional Model(s) / Zusätzliche(s) Modell(e)** : 2835 CCT-03, 2835 CCT-12, 2835 CCT-24  
**Trade Mark / Warenzeichen** :   
**Test Standard / Geprüft nach** : EN62479:2010, EN IEC 62368-1:2024+A11:2024  
ETSI EN 301 489-1 V2.2.3, ETSI EN 300 328 V 2.2.2  
ETSI EN 301 489-17 V3.2.4  
**Test Report No./Bericht Nr** : ZHT-250114113R01

The certificate is issued in accordance with annex III of the RED Directive 2014/53/EU of 13th March, 2014

This certificate of conformity is based on a single evaluation of the submitted sample(s) of the above mentioned product. It does not imply an assessment of the whole production and other relevant directives have to be observed.



The information of the certificate can be checked through [www.zht-lab.cn](http://www.zht-lab.cn).  
The CE mark which is shown on the certificate can only be used under the conditions that the products complete with all of the relevant Directives of EC Declaration of Conformity.  
The Manufacturer should be responsible for the internal production control so that the products complied with the essential requirements of the above mentioned Directive(s). Certificate holder must notify all changes to the original certification laboratory of Guangdong Zhonghan Testing Technology Co., Ltd.



**Guangdong Zhonghan Testing Technology Co., Ltd.**  
**Address:** Room 104/201, Building 1, Yibaolai Industrial Park, Qiaotou, Fuhai Subdistrict, Bao'an District, Shenzhen, Guangdong, China  
**Tel.:** +86-755-27782934 **Http://**[www.zht-lab.cn](http://www.zht-lab.cn) **E-mail:** [admin@zht-lab.cn](mailto:admin@zht-lab.cn)