

Assembling instruction

/ Montageanleitung

118660 118661 118662 118663 118664

118665 118666 118667 118668 118669

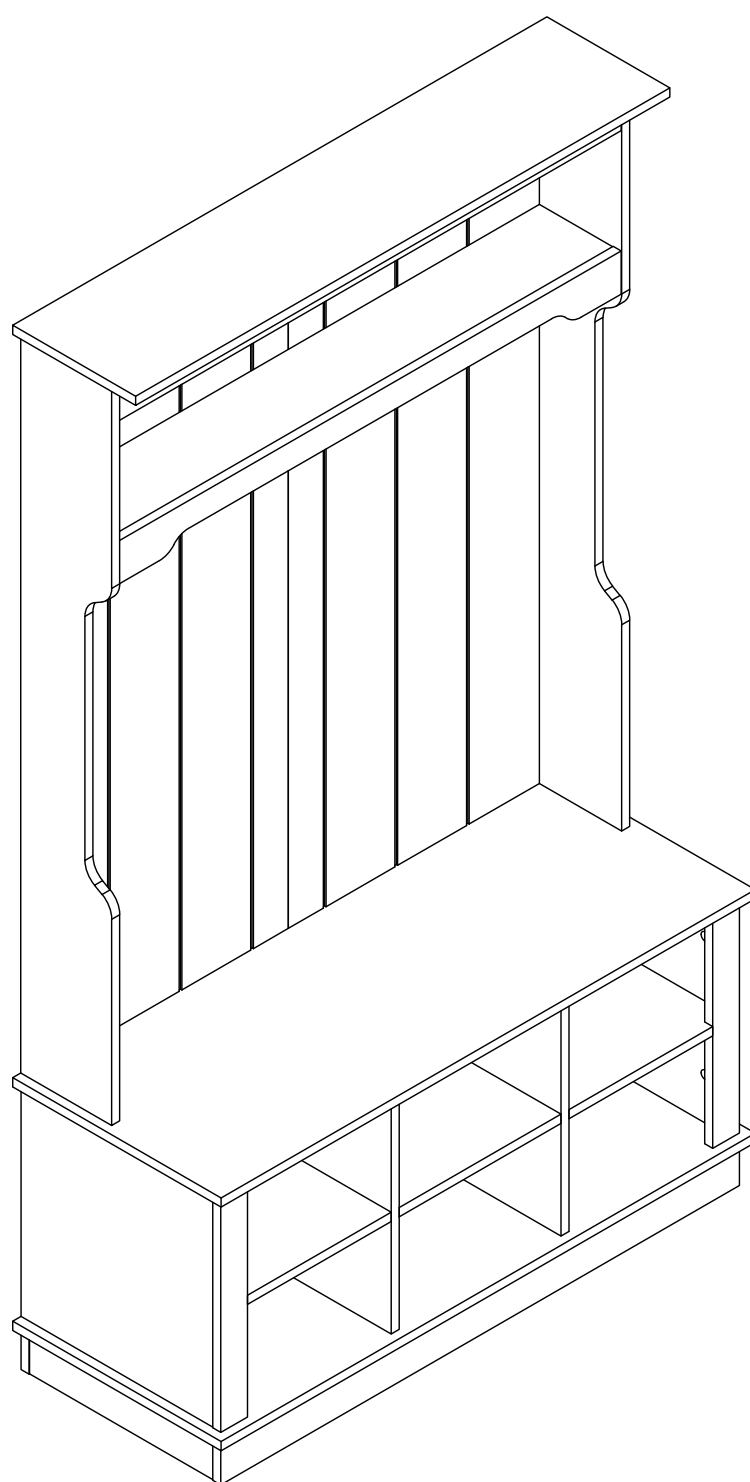

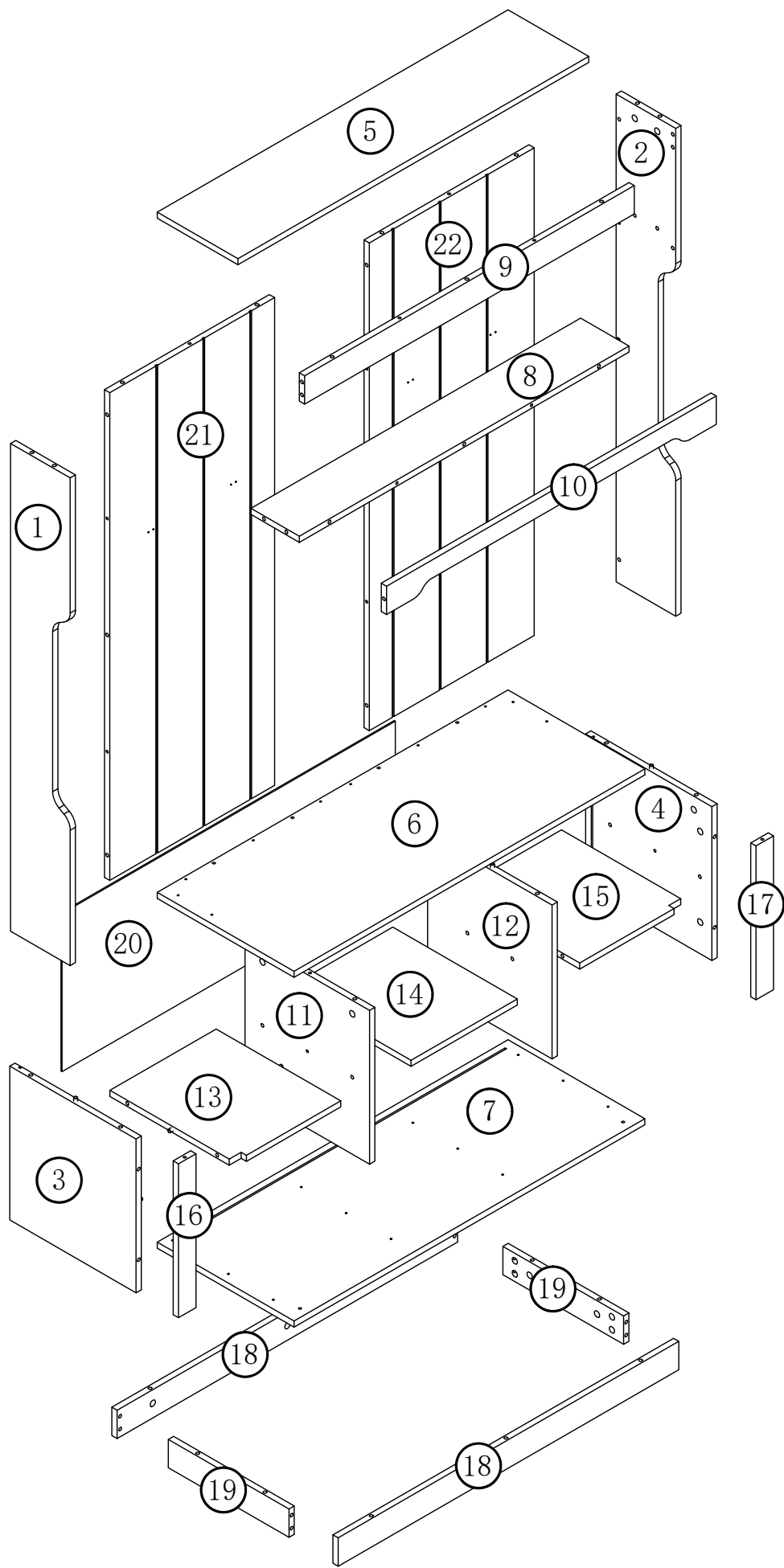



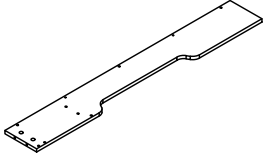
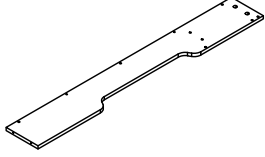
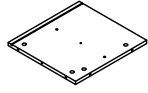
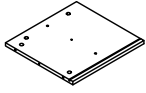
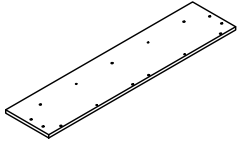
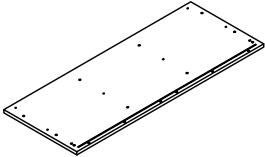
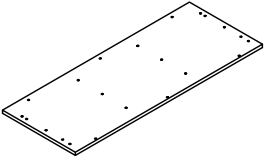
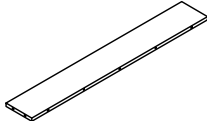
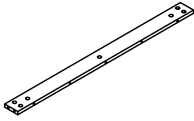
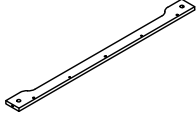
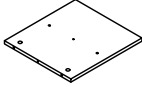
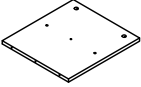
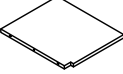
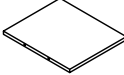
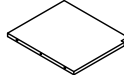
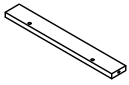
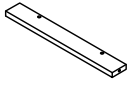
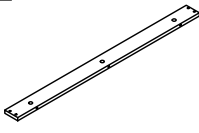
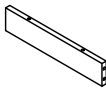
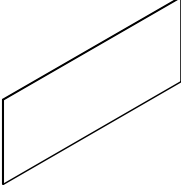
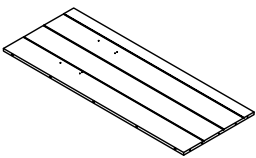
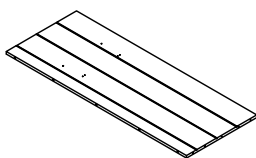

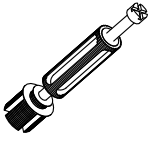

PART LIST / TEILELISTE

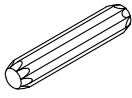
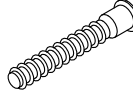
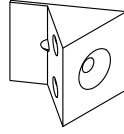
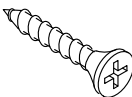
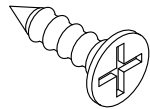
<p>1</p> 	<p>2</p> 	<p>3</p> 	<p>4</p> 	<p>5</p> 
<p>Upper Left Side Panel 1PC</p>	<p>Upper Right Side Panel 1PC</p>	<p>Lower Left Side Panel 1PC</p>	<p>Lower Right Side Panel 1PC</p>	<p>Top Panel 1PC</p>
<p>6</p> 	<p>7</p> 	<p>8</p> 	<p>9</p> 	<p>10</p> 
<p>Seat Panel 1PC</p>	<p>Bottom Panel 1PC</p>	<p>Upper Shelf 1PC</p>	<p>Top Valance 1PC</p>	<p>Upper Baffle 1PC</p>
<p>11</p> 	<p>12</p> 	<p>13</p> 	<p>14</p> 	<p>15</p> 
<p>Left Vertical Divider 1PC</p>	<p>Right Vertical Divider 1PC</p>	<p>Left Horizontal Panel 1PC</p>	<p>Middle Shelf 1PC</p>	<p>Right Horizontal Panel 1PC</p>
<p>16</p> 	<p>17</p> 	<p>18</p> 	<p>19</p> 	<p>20</p> 
<p>Left Edge Trim 1PC</p>	<p>Right Edge Trim 1PC</p>	<p>Toe Kick 2PCS</p>	<p>Toe Kick Side Panel 2PCS</p>	<p>Back Panel 2PCS</p>
<p>21</p> 	<p>22</p> 			
<p>Left Back Panel 1PC</p>	<p>Right Back Panel 1PC</p>			

HARDWARE LIST / Montageteile

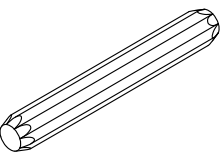
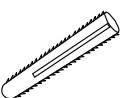
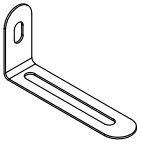
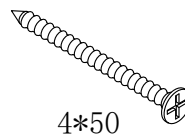
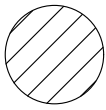
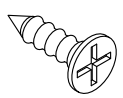
<p>A</p> 	<p>B</p> 	<p>C</p>  <p>8*40</p>	<p>D</p>  <p>7*50</p>	<p>E</p> 
<p>Three-in-one Connector 72PCS</p>	<p>Eccentric Connector 75PCS</p>	<p>Wooden Dowel 26PCS</p>	<p>Screw 26PCS</p>	<p>Back Panel Clip 4PCS</p>
<p>F</p>  <p>3*12</p>	<p>G</p>  <p>3.5*14</p>	<p>H</p>  <p>10*11</p>	<p>I</p>  <p>6*60</p>	<p>J</p> 
<p>Screw 4PCS</p>	<p>Screw 2PCS</p>	<p>Hammer Head Nut 3PCS</p>	<p>Cam Lock Connector Bolt 3PCS</p>	<p>Hook 4PCS</p>
<p>K</p>  <p>8*60</p>	<p>L</p>  <p>8*40</p>	<p>M</p> 	<p>N</p>  <p>4*50</p>	<p>O</p> 
<p>Wooden Dowel 2PCS</p>	<p>Expansion Tube 2PCS</p>	<p>Large L-shaped Anti-tip Bracket 2PCS</p>	<p>Screw 2PCS</p>	<p>Hole Concealer Caps 60PCS</p>
<p>P</p>  <p>3.5*14</p> <p>Black Screw 8PCS</p>				

Step 1. Attach Three-in-one Connector (part A) to Panel (part 1 2 3 4 5 6 7 10)

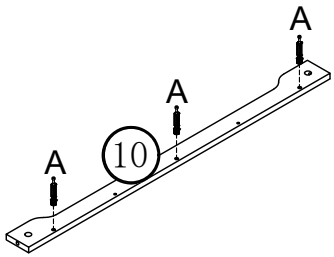
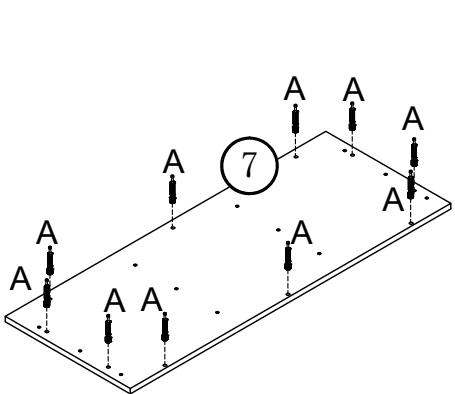
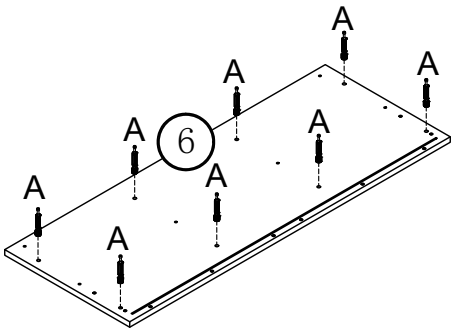
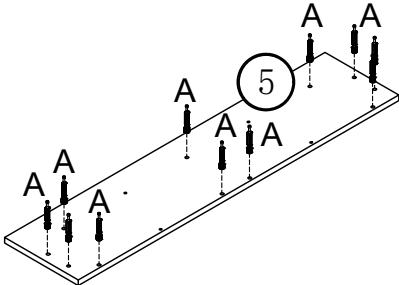
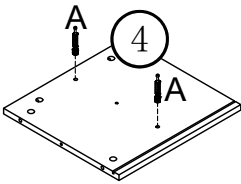
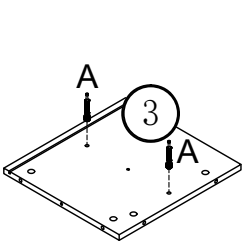
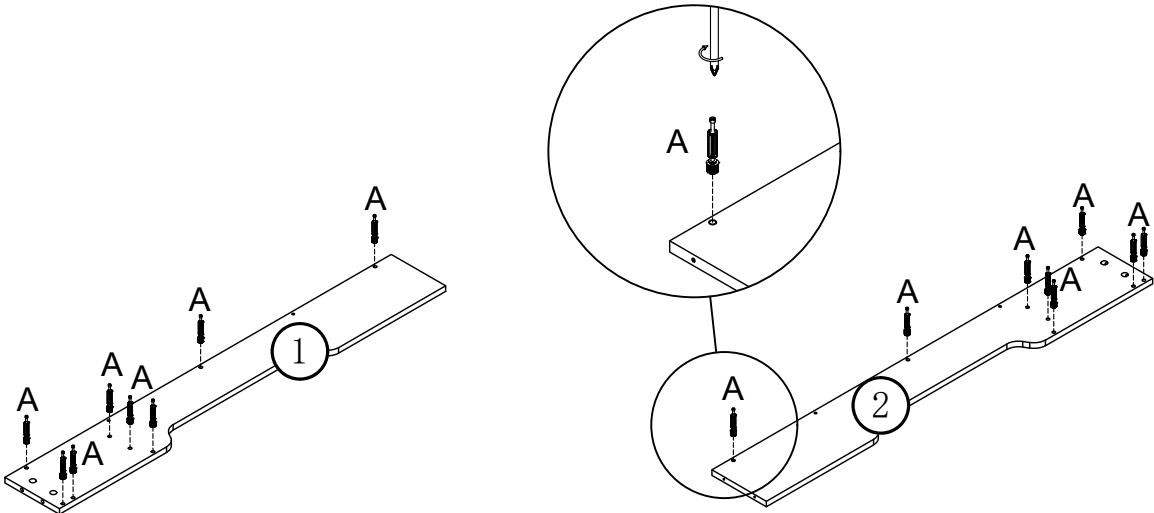

A*52

Step 2. Attach Three-in-one Connector (part A) to Panel (part 11 12 16 17 18)

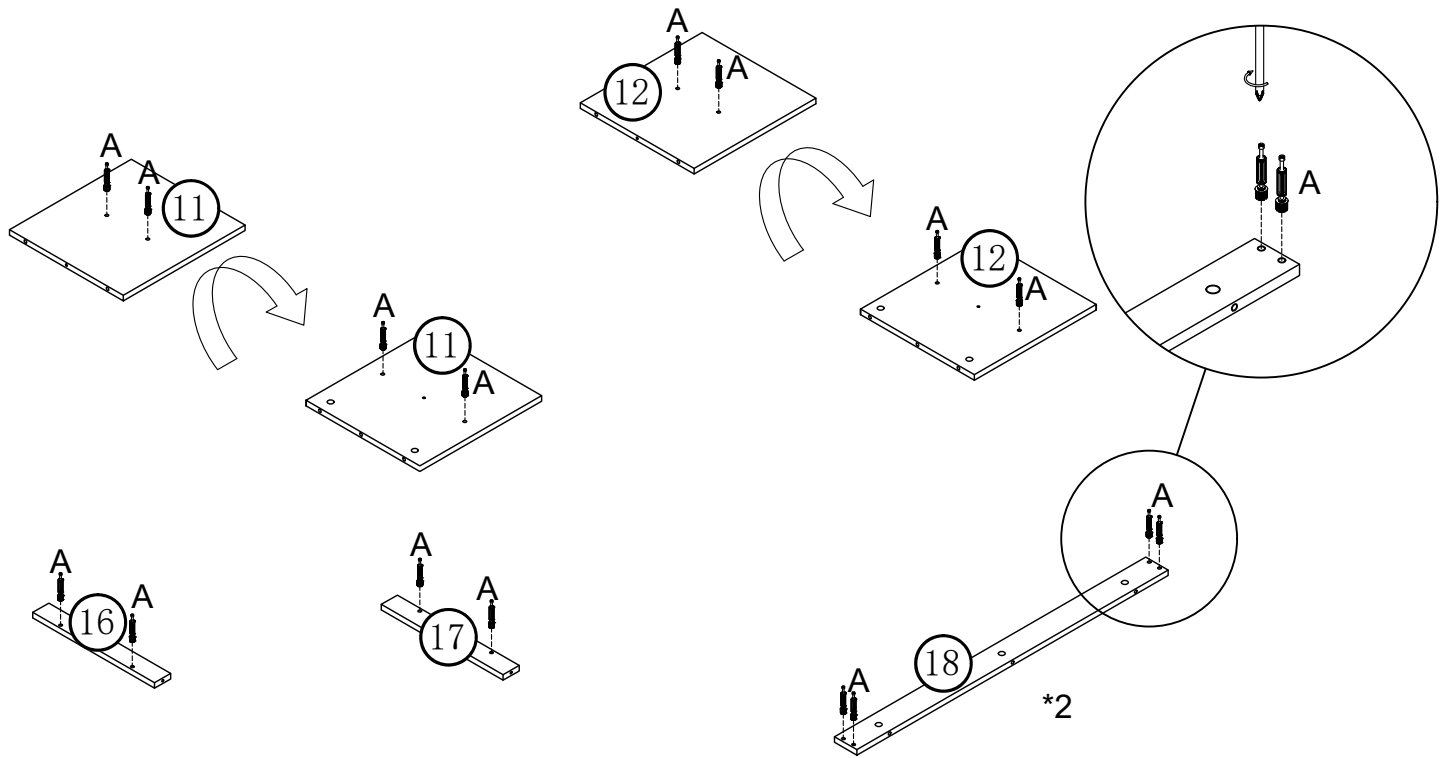

	A*20
--	------

Step 3. Insert the hammer head nut (Part H) into the pre-drilled hole of Panel (Part 21), aligning its side hole with the panel's edge bore. Then connect and tighten the Cam Lock Connector Bolt (Part I) to the hammer head nut using a screwdriver.

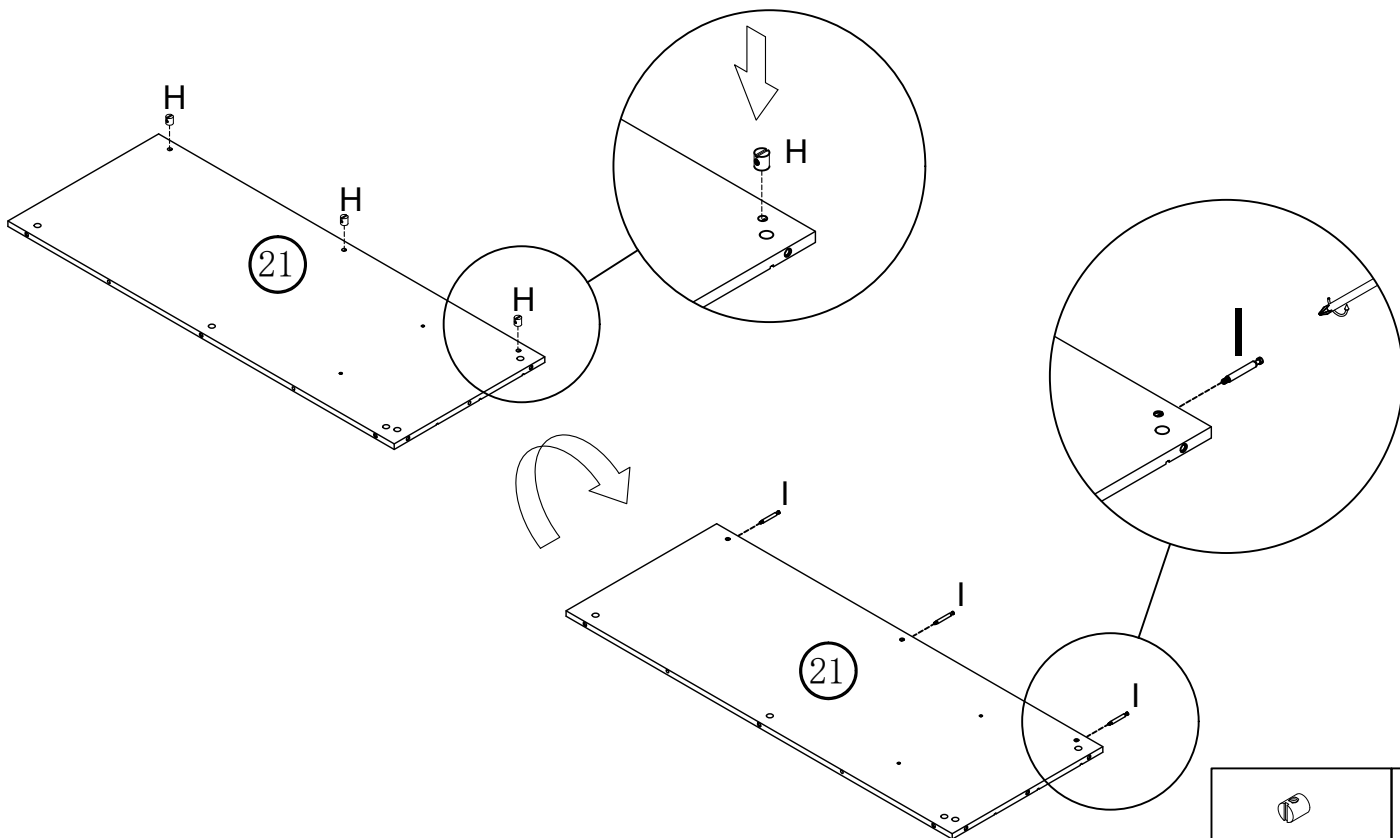

	H*3
	I*3

Step 4. Attach Panel (part 21) to Panel (part 22) using Eccentric Connector (part B) and Wooden Dowel (part K).
 Attach Panel (part 8) to Panel (part 10) using Eccentric Connector (part B) and Wooden Dowel (part C)

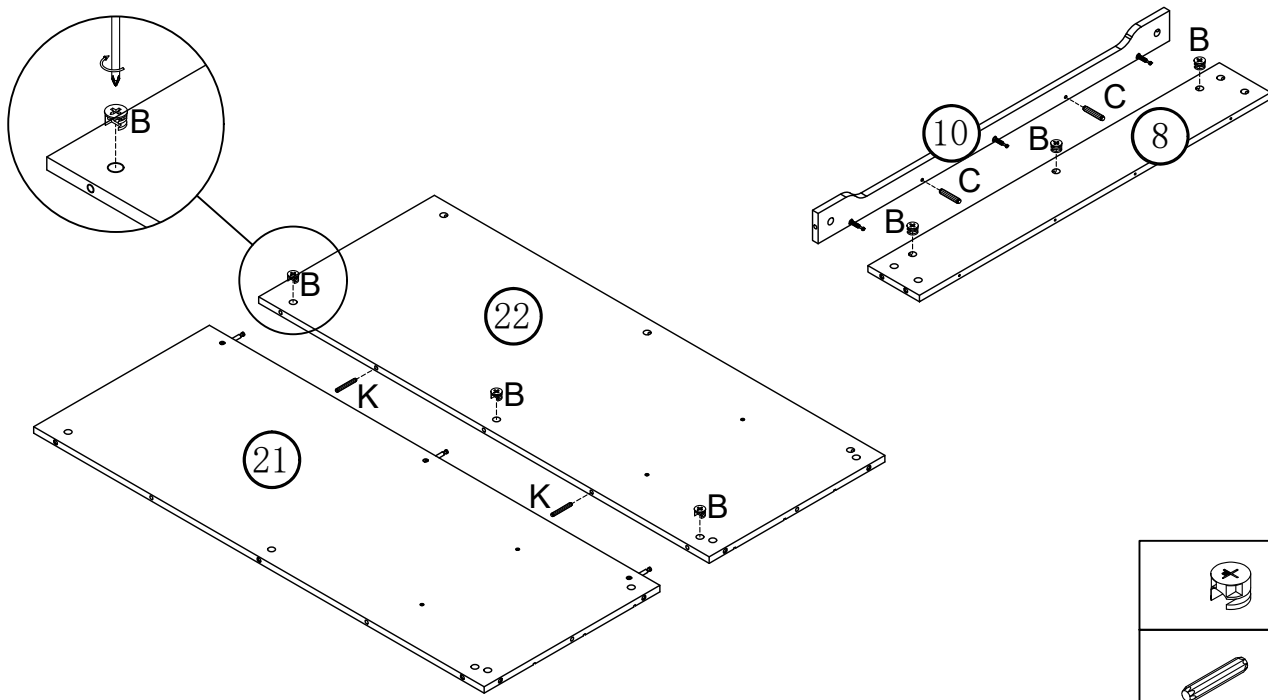

	B*6
	C*2
	K*2

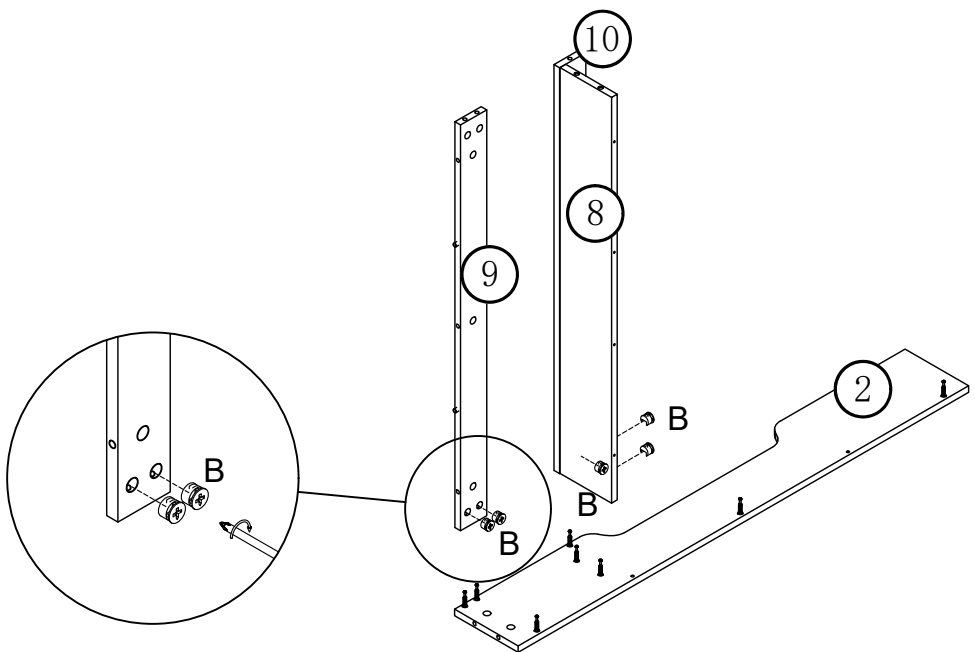

Step 5. Attach Panel (part 8 9 10) to Panel (part 2) using Eccentric Connector (part B)



	B*5
--	-----

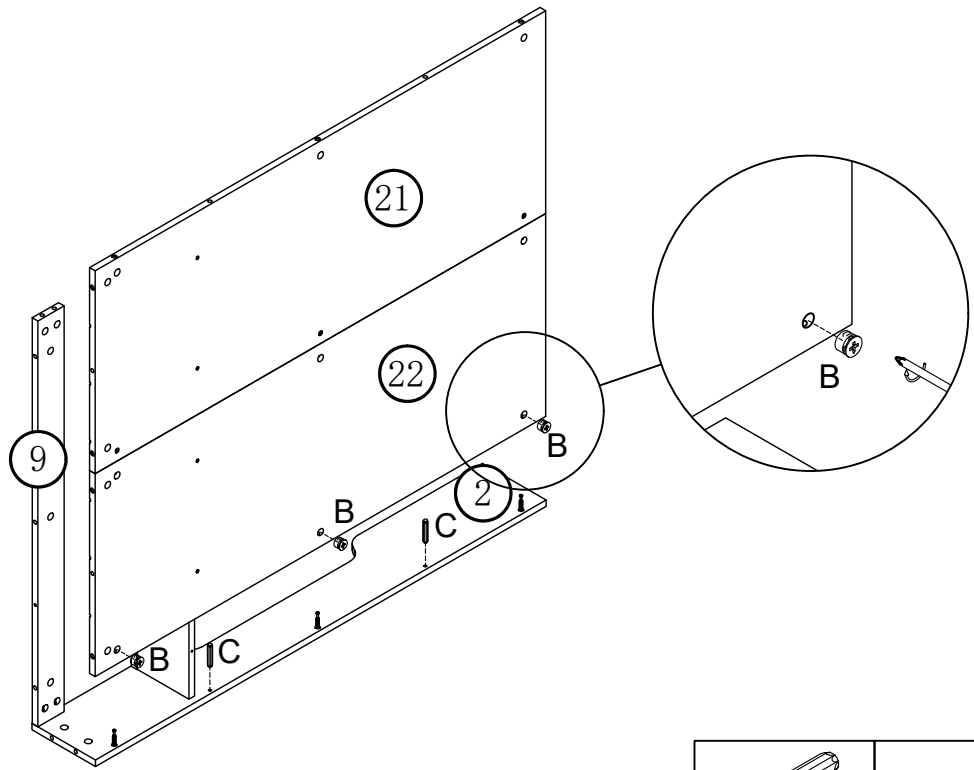

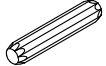
Step 6. Attach Panel (part 22) to Panel (part 2) using Eccentric Connector (part B) and Wooden Dowel (part C)



	C*2
	B*3

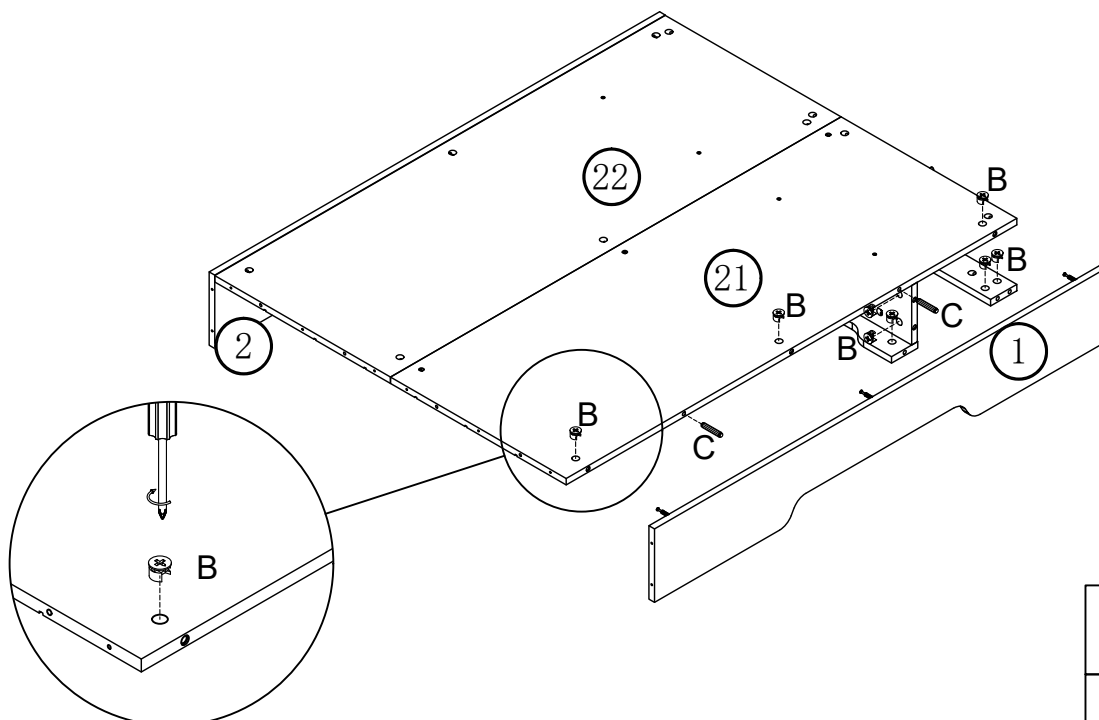

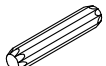
Step 7. Attach Panel (part 1) to Panel (part 8 9 10 21) using Eccentric Connector (part B) and Wooden Dowel (part C)



	C*2
	B*8

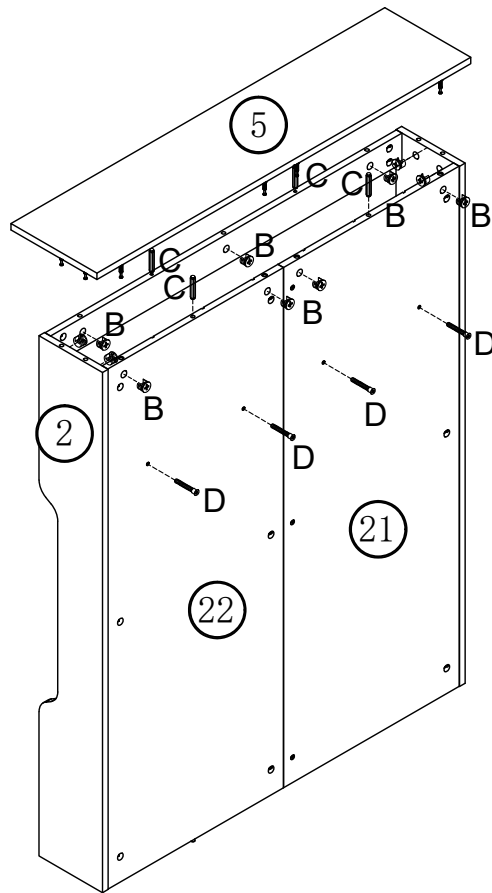

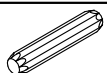

Step 8. Attach Panel (part 5) to Panel (part 1 2 9 21 22) using Eccentric Connector (part B) and Wooden Dowel (part C)
 Attach Panel (part 8) to Panel (part 21 22) using Screw (part D)

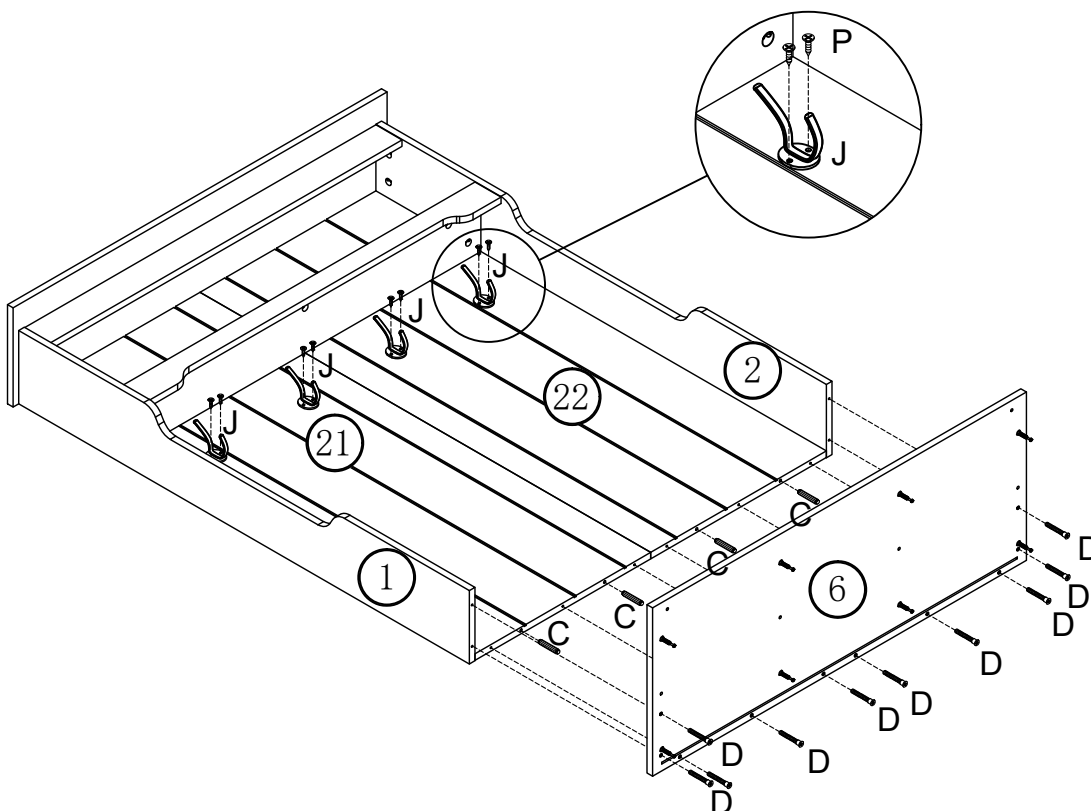

	B*11
	C*4
	D*4

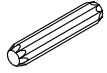
Step 9. Attach Panel (part 6) to Panel (part 1 2 21 22) using Screw (part D) and Wooden Dowel (part C)
 Attach hooks (part J) to Panel (part 21 22) using Black screws (part J)



	C*4
	D*10
	J*4
	P*8

Step 10. Attach Panel (part 11 12) to Panel (part 14) using Eccentric Connector (part B)

Attach Panel (part 13 15) to Panel (part 11 12) using Eccentric Connector (part B) and Wooden Dowel (part C)

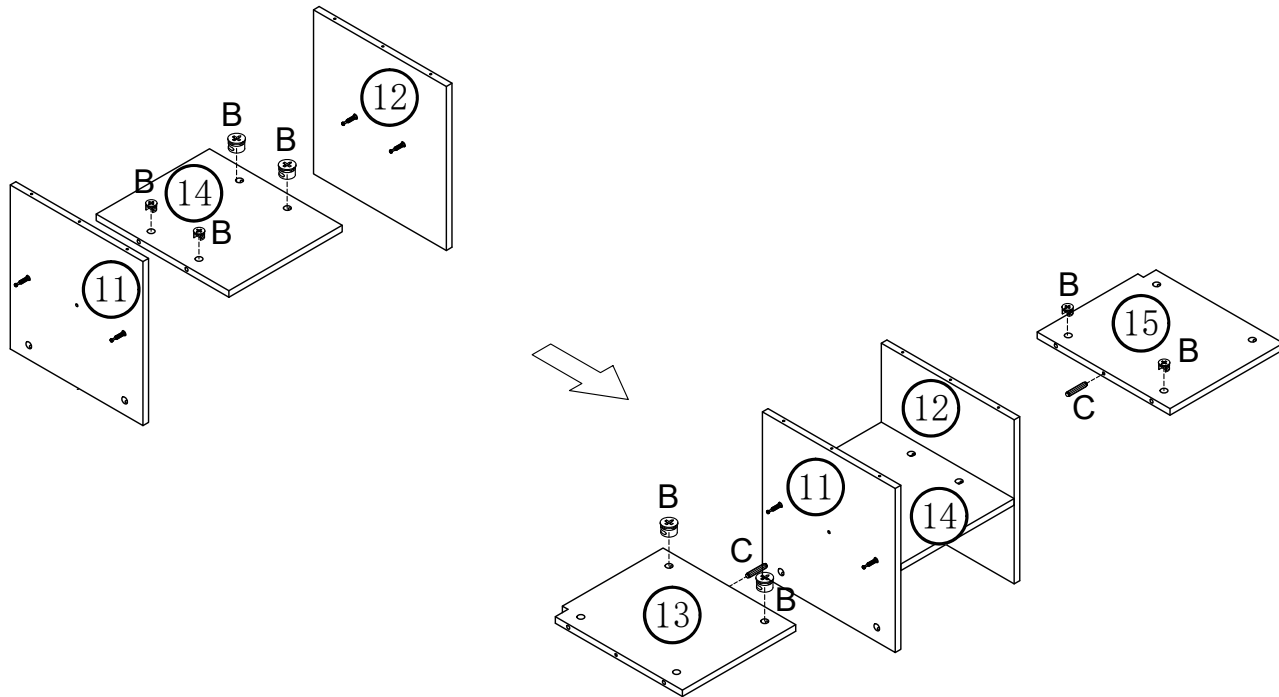

	B*8
	C*2

Step 11. Attach Panel (part 16) to Panel (part 3) using Eccentric Connector

Attach Panel (part 17) to Panel (part 4) using Eccentric Connector

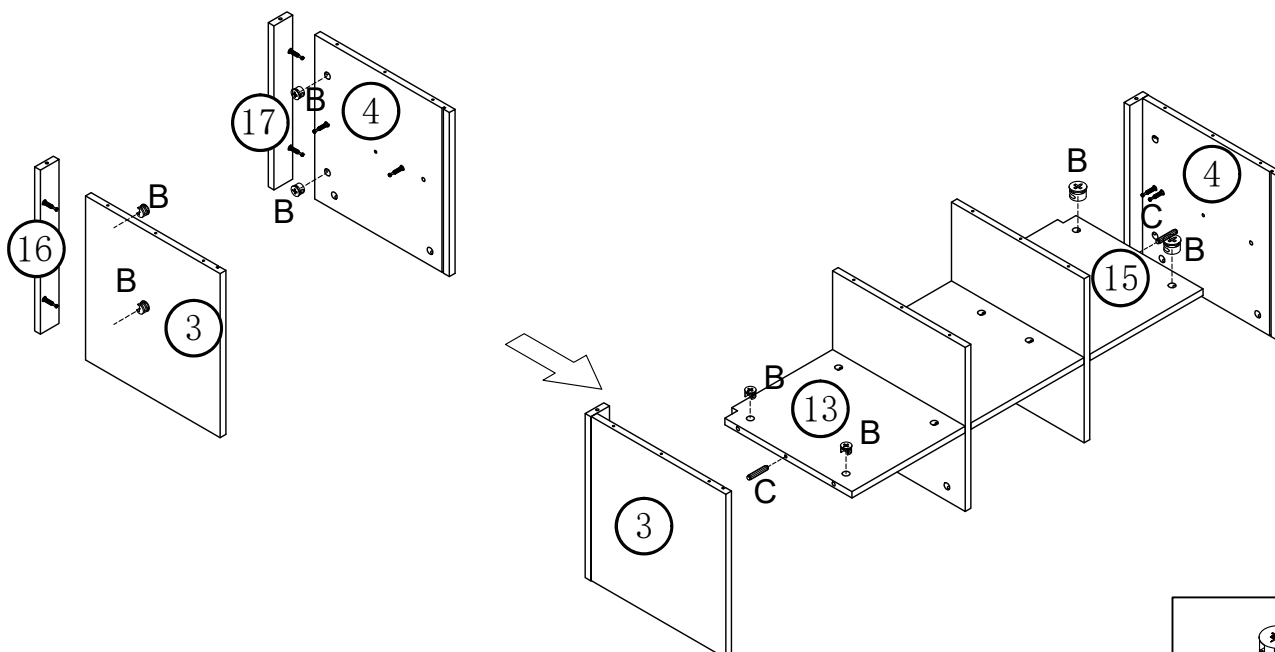

Attach Panel (part 3 4) to Panel (part 13 15) using Eccentric Connector and Wooden Dowel (part C)

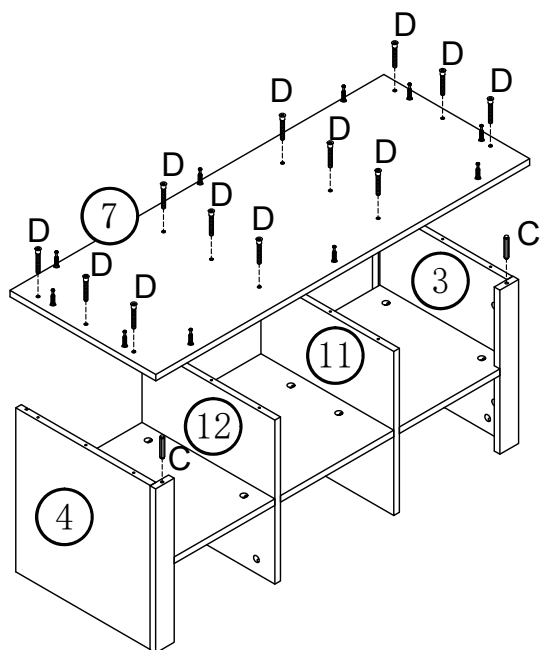

	B*8
	C*2

Step 12. Attach Panel (part 7) to Panel (part 3 4 11 12) using Wooden Dowel (part C) and Screw (part D)

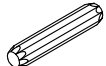

	C*2
	D*12

Step 13. Attach Panel (part 19) to Panel (part 18) using Eccentric Connector (part B)

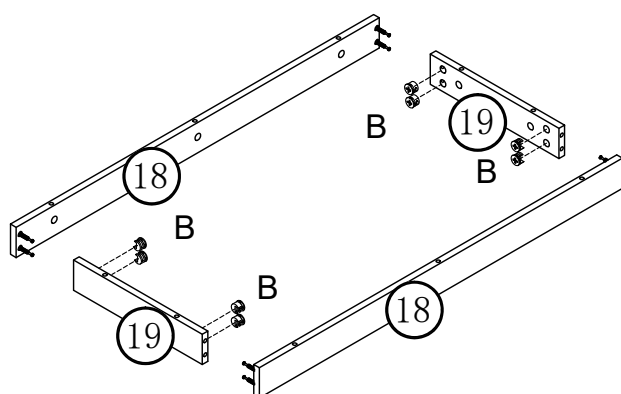

	B*8
---	-----

Step 14. Attach Panel (part 18 19) to Panel (part 7) using Eccentric Connector (part B)

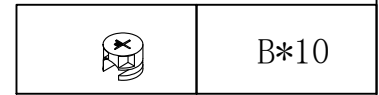
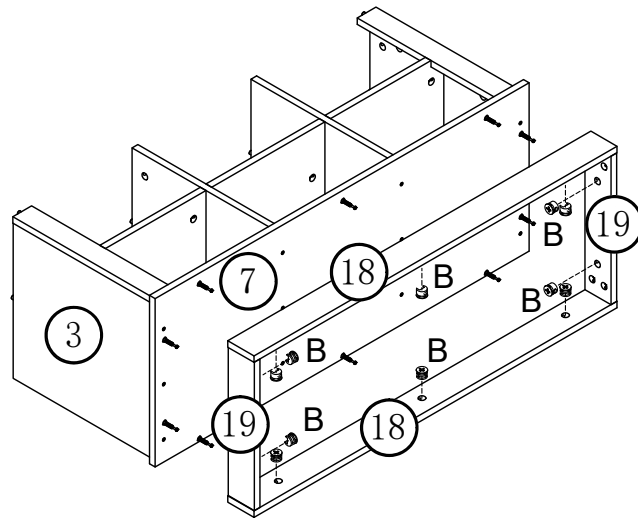

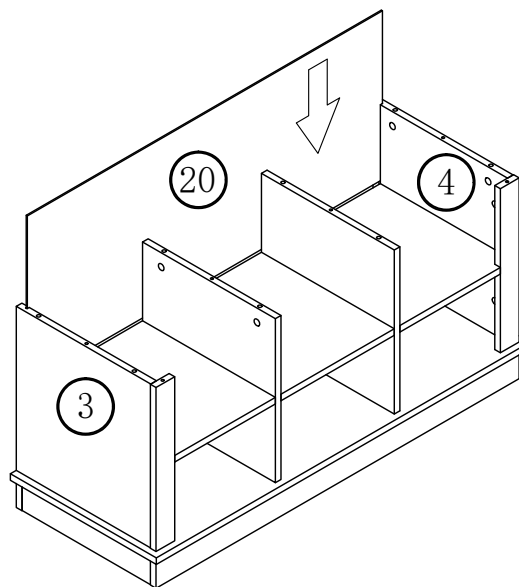

Step 15. Slide panels (part 20) into grooves of assembled unit (Parts 3 4) as shown.



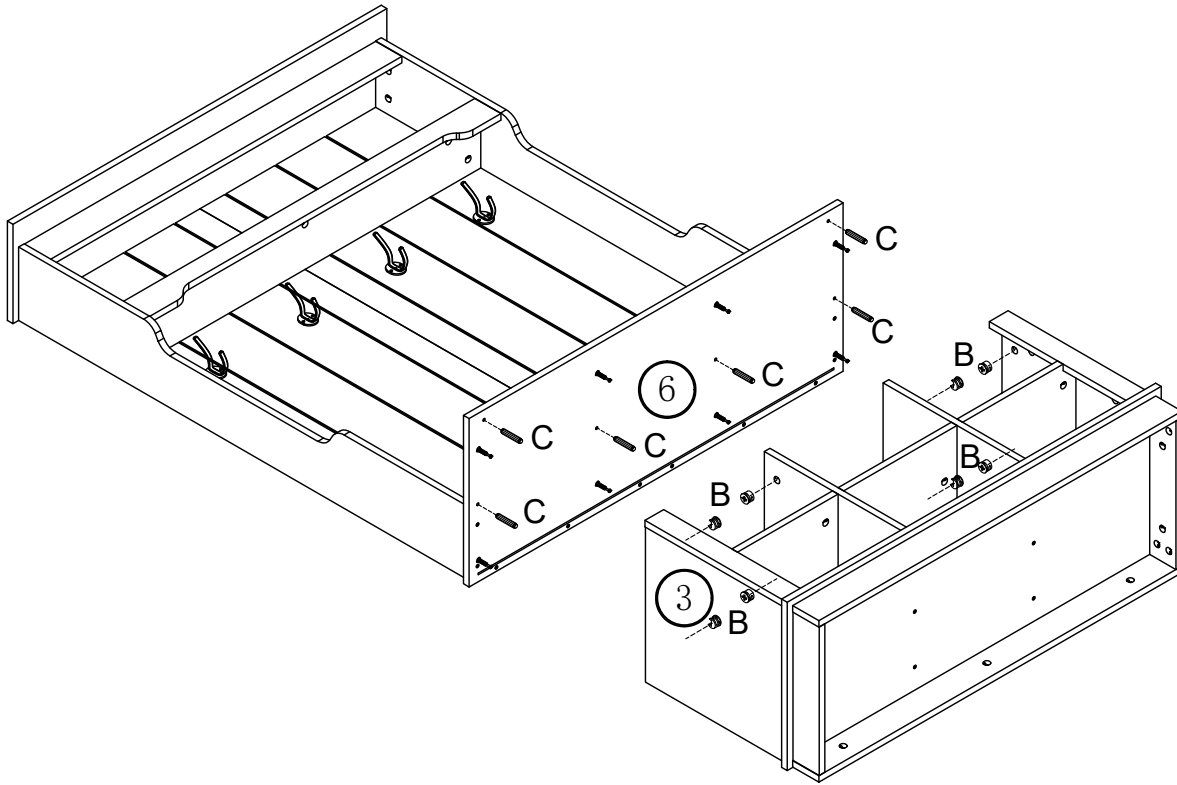

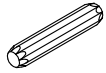

Step 16. Attach Panel (part 3 4 11 12) to Panel (part 6) using Eccentric Connector (part B) and Wooden Dowel (part C)

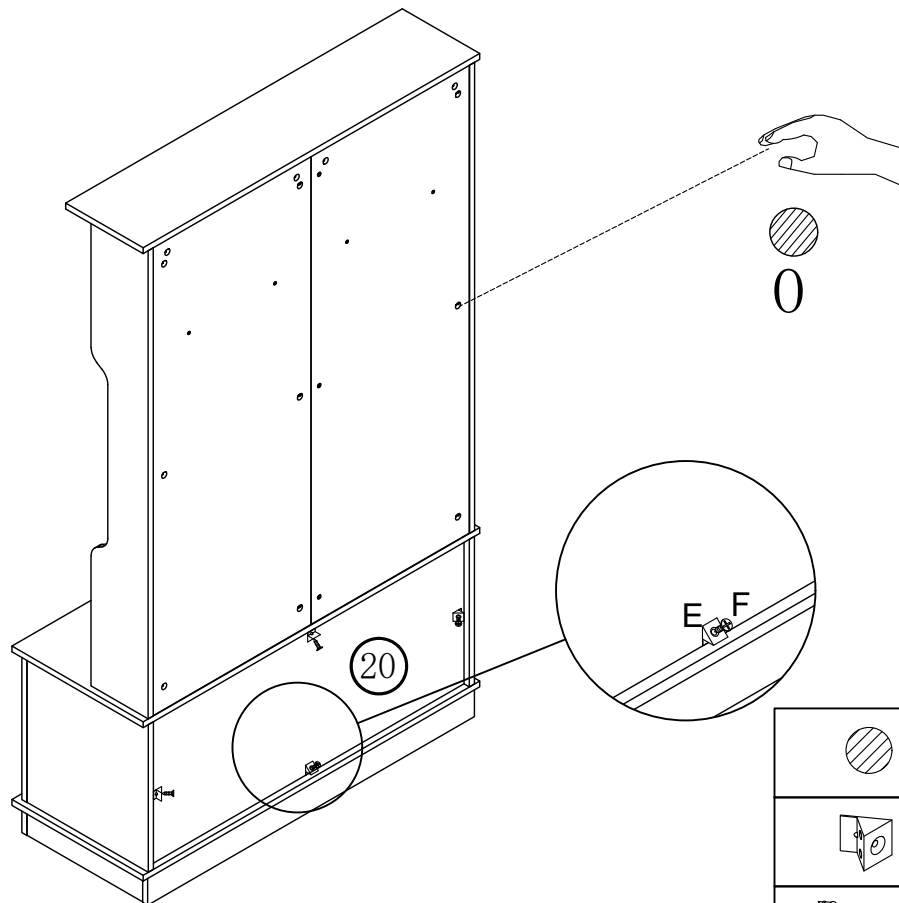

	C*6
	B*8

Step 17. Attach Back Panel Clip (part E) to Panel (part 20) using Screw (part F)
Stick on the hole concealer caps to cover the unused holes.

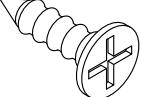
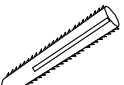
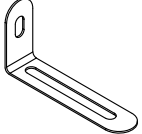
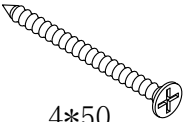

	O*54
	E*4
	F*4

G  3.5*14	L  8*40	M 	N  4*50
Screw 2PCS	Expansion Tube 2PCS	Large L-shaped Anti-tip Bracket 2PCS	Screw 2PCS

SAFETY WALL STRAP INSTALLATION

Note: it is highly recommended to install this safety strap kit to prevent tipping, damage and/or injury.

First, attach the anti - tipping screw G of the large L - shaped bracket to Board 5. Then, drill a hole in the wall at a height precisely matching the hole position of the large L on Board 5. Insert the expansion tube L into the drilled hole, and finally, secure screw N to the wall via the large L - shaped bracket.

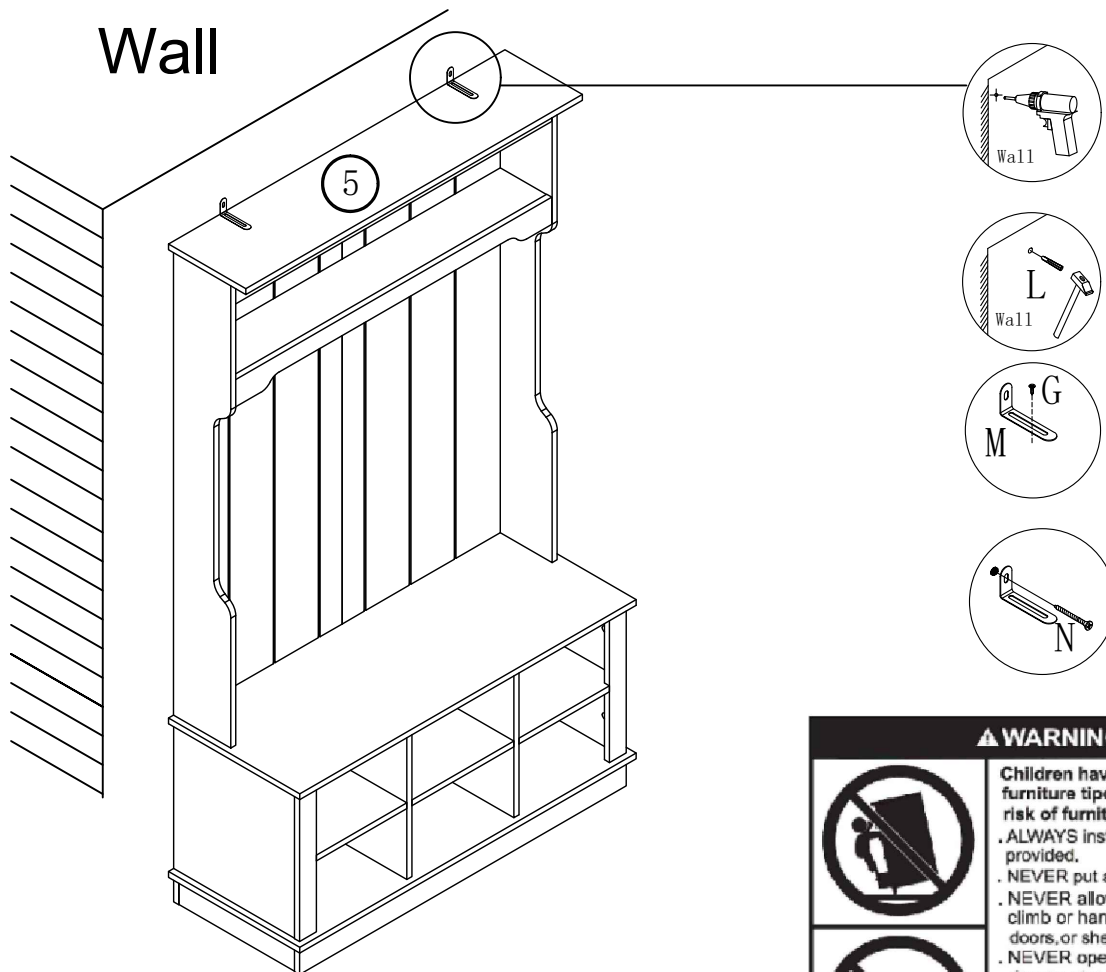

▲ WARNING	
	<p>Children have died from furniture tipover. To reduce the risk of furniture tipover:</p> <ul style="list-style-type: none"> • ALWAYS install tipover restraint provided. • NEVER put a TV on this product. • NEVER allow children to stand, climb or hang on drawers, doors, or shelves. • NEVER open more than one drawer at a time. • Place heaviest items in the lowest drawers.
	<p><i>This is a permanent label. Do not remove!</i></p>

Schritt 1:

Drei-in-eins-Verbinder (Teil A) an Platte (Teil 1, 2, 3, 4, 5, 6, 7, 10) befestigen.

Schritt 2:

Drei-in-eins-Verbinder (Teil A) an Platte (Teil 11, 12, 16, 17, 18) befestigen.

Schritt 3: Die Hammerkopfmutter (Teil H) in die vorgebohrte Bohrung von Platte (Teil 21) einsetzen und dabei die seitliche Bohrung mit der Bohrung am Plattenrand ausrichten. Anschließend den Nockenverbinderbolzen (Teil I) mit einem Schraubendreher an der Hammerkopfmutter befestigen und festziehen.

Schritt 4:

Platte (Teil 21) mit Exzenterverbinder (Teil B) und Holzdübel (Teil K) an Platte (Teil 22) befestigen. Platte (Teil 8) mit Exzenterverbinder (Teil B) und Holzdübel (Teil C) an Platte (Teil 10) befestigen.

Schritt 5:

Platte (Teil 8, 9, 10) mit Exzenterverbinder (Teil B) an Platte (Teil 2) befestigen.

Schritt 6:

Platte (Teil 22) mit Exzenterverbinder (Teil B) und Holzdübel (Teil C) an Platte (Teil 2) befestigen.

Schritt 7:

Platte (Teil 1) mit Exzenterverbinder (Teil B) und Holzdübel (Teil C) an Platte (Teil 8, 9, 10, 21) befestigen.

Schritt 8:

Platte (Teil 5) mit Exzenterverbinder (Teil B) und Holzdübel (Teil C) an Platte (Teil 1, 2, 9, 21, 22) befestigen. Platte (Teil 8) mit Schraube (Teil D) an Platte (Teil 21, 22) befestigen.

Schritt 9:

Platte (Teil 6) mit Schraube (Teil D) und Holzdübel (Teil C) an Platte (Teil 1, 2, 21, 22) befestigen. Haken (Teil J) mit schwarzen Schrauben (Teil J) an Platte (Teil 21, 22) befestigen.

Schritt 10:

Platte (Teil 11, 12) mit Exzenterverbinder (Teil B) an Platte (Teil 14) befestigen. Platte (Teil 13, 15) mit Exzenterverbinder (Teil B) und Holzdübel (Teil C) an Platte (Teil 11, 12) befestigen.

Schritt 11:

Platte (Teil 16) mit Exzenterverbinder an Platte (Teil 3) befestigen. Platte (Teil 17) mit Exzenterverbinder an Platte (Teil 4) befestigen. Platte (Teil 3, 4) mit Exzenterverbinder und Holzdübel (Teil C) an Platte (Teil 13, 15) befestigen.

Schritt 12: Platte (Teil 7) mit Holzdübel (Teil C) und Schraube (Teil D) an Platte (Teil 3, 4, 11, 12) befestigen.

Schritt 13:

Platte (Teil 19) mit Platte (Teil 18) mit Exzenterverbinder (Teil B)

Schritt 14:

Platte (Teil 18, 19) mit Exzenterverbinder (Teil B) an Platte (Teil 7) befestigen.

Schritt 15:

Platten (Teil 20) wie abgebildet in die Nuten der montierten Einheit (Teile 3, 4) schieben.

Schritt 16:

Platte (Teil 3, 4, 11, 12) mit Exzenterverbinder (Teil B) und Holzdübel (Teil C) an Platte (Teil 6) befestigen.

Schritt 17: Rückplattenclip (Teil E) mit Schraube (Teil F) an Platte (Teil 20) befestigen. Die Lochabdeckungen aufkleben, um die ungenutzten Löcher abzudecken.

INSTALLATION DER SICHERHEITSWANDBEFESTIGUNG

Hinweis: Es wird dringend empfohlen, diese Sicherheitswandbefestigung zu installieren, um ein Umkippen, Beschädigungen und/oder Verletzungen zu vermeiden. Befestigen Sie zunächst die Kippschutzschraube G der großen L-förmigen Halterung an Platte 5. Bohren Sie dann ein Loch in die Wand, und zwar auf einer Höhe, die genau der Lochposition des großen L an Platte 5 entspricht. Stecken Sie das Spreizrohr L in das gebohrte Loch und befestigen Sie schließlich die Schraube N über die große L-förmige Halterung an der Wand.

! Achtung / Warnung / Kippgefahr !

Risiko: Kinder sind an umkippenden Möbeln gestorben.

Risikoreduzierung:

- Immer die mitgelieferte Kippsicherung anbringen.
- Niemals einen Fernseher auf dieses Produkt stellen.
- Niemals Kindern erlauben, auf Schubladen, Türen oder Regalen zu stehen, zu klettern oder daran zu hängen.
- Niemals mehr als eine Schublade gleichzeitig öffnen.
- Schwerste Gegenstände in die untersten Schubladen legen.

