

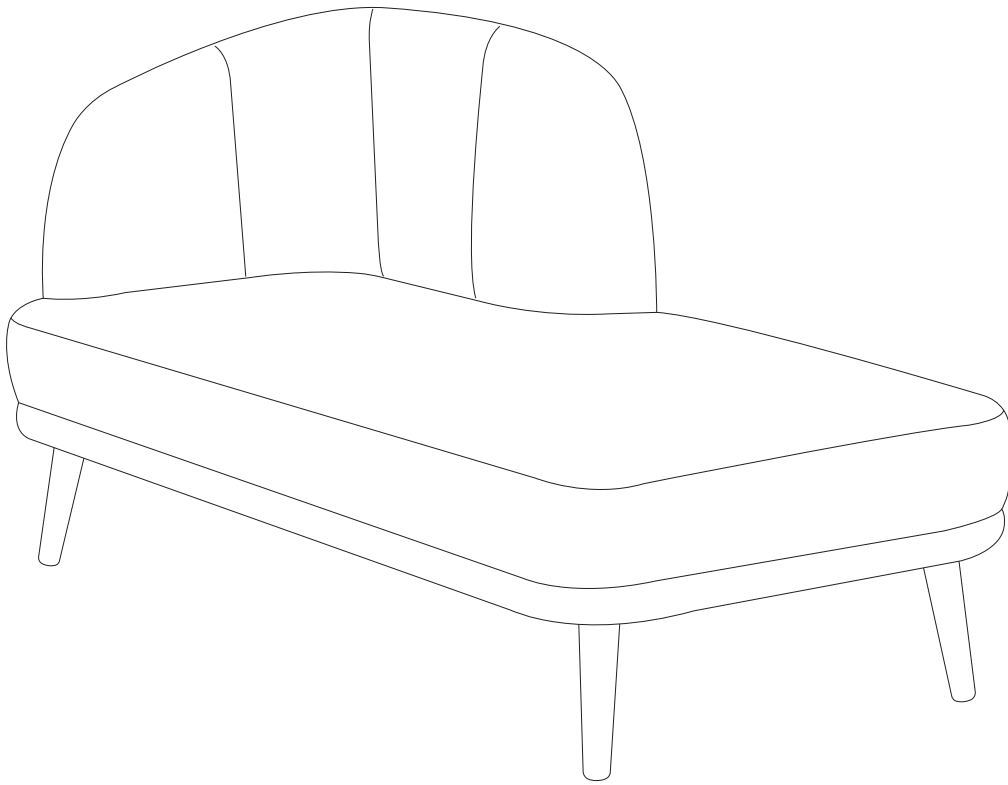

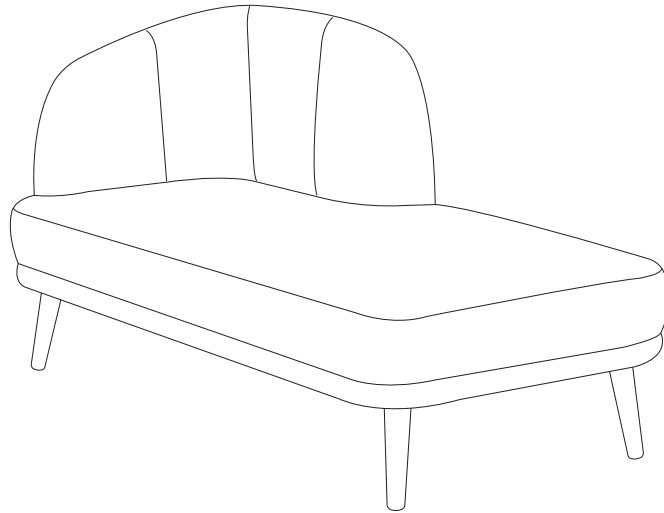

TANLAY

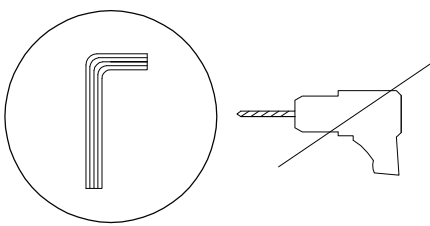

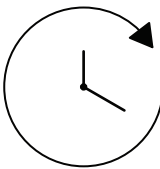
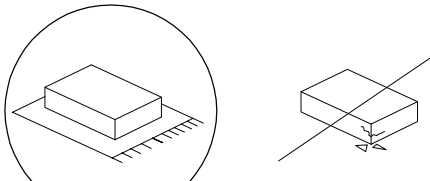

		
		15'
		
		1

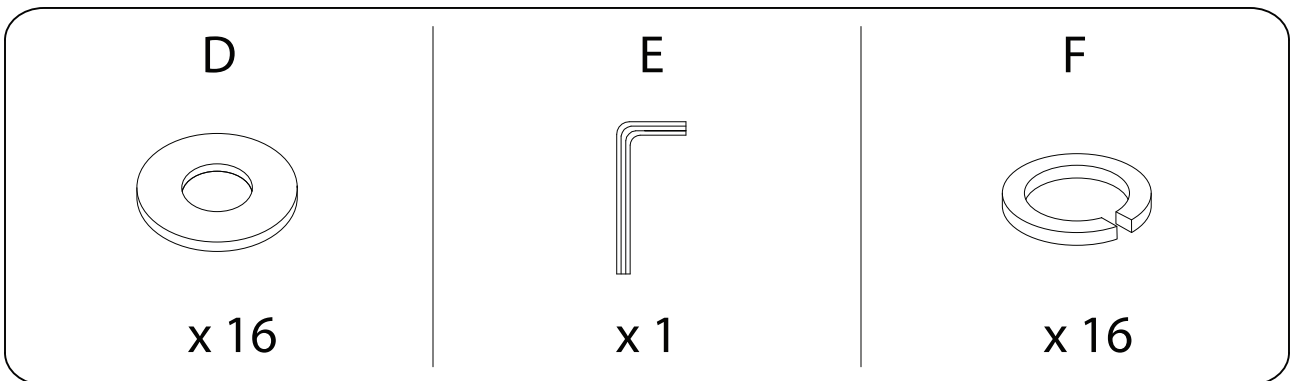
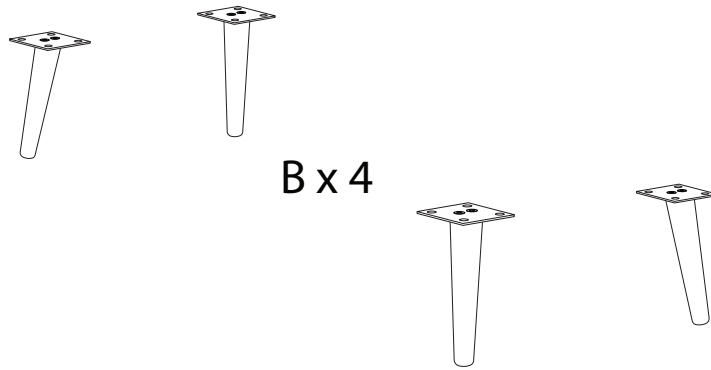
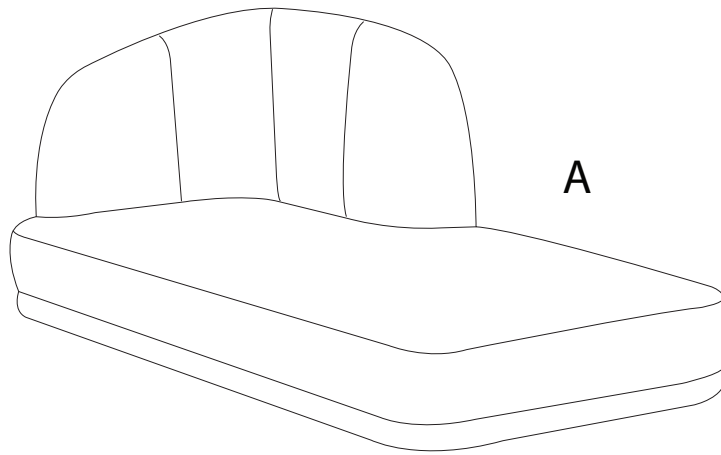
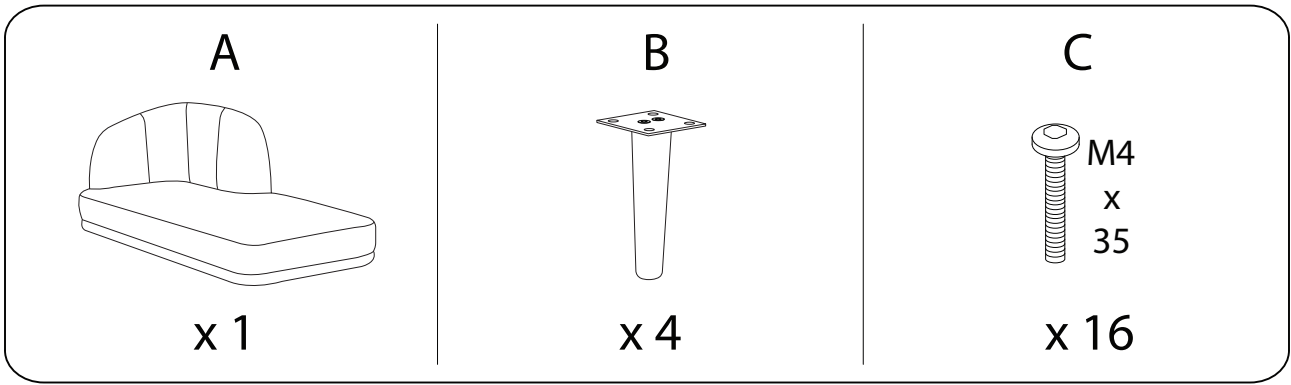

1

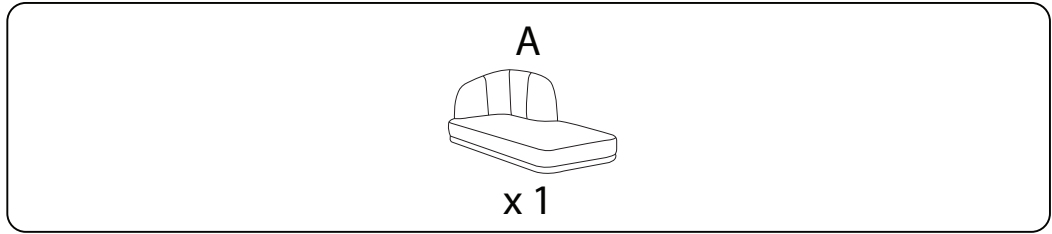

2

