

Montageanleitung:
 Korpus - Regalserie M6.../M7.../M8...
 Assembly instruction : corpus - shelves M6.../M7.../M8...

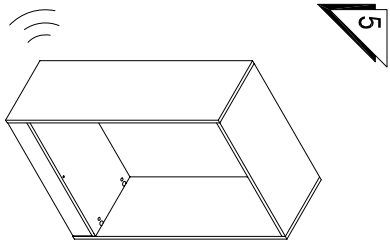

5

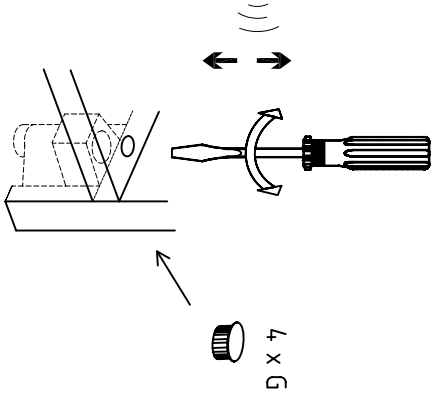

4 x G

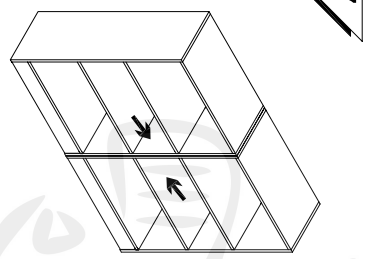

7

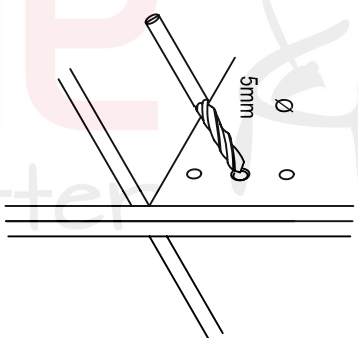

5mm Ø

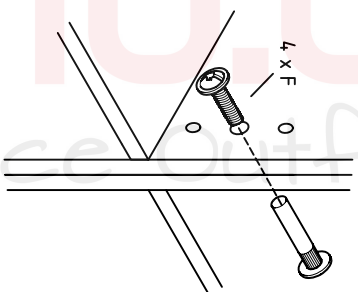

4 x F

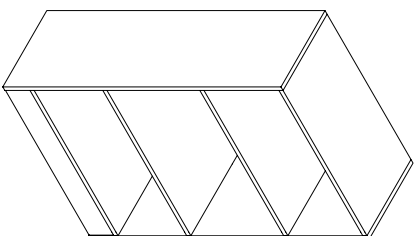

M 6500

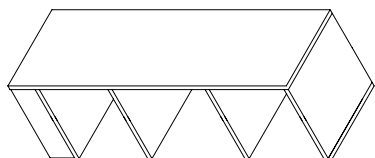

M 6050

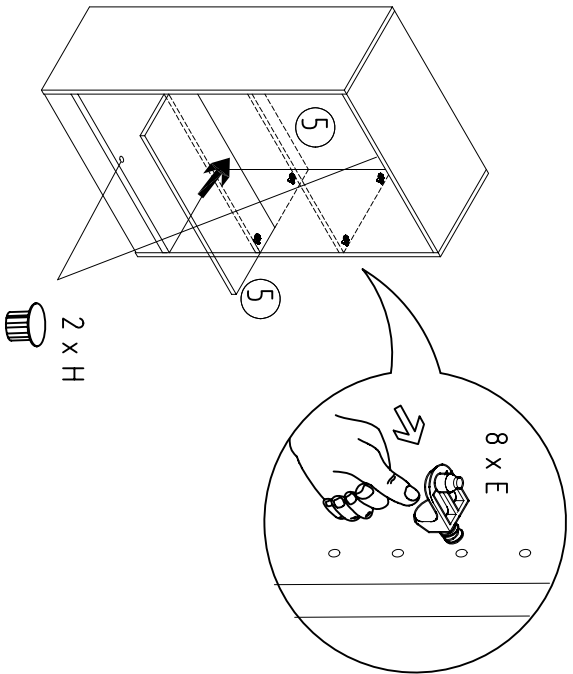

8 x E



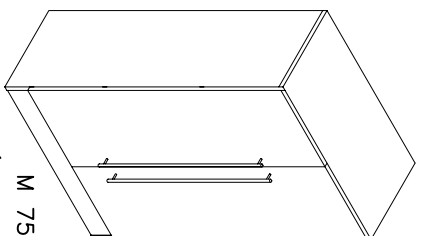





2 x H



M 7550
 (M 8550)

bümo.de
 Your Office Outfitter

Inhalt Beschlagenteil :
Fittings :

4 x A 	12 x B  (4 x 16 mm)	8 x C 	6 x D  (3,5 x 25 mm)
8 x E 	4 x F 	4 x G 	2 x H 

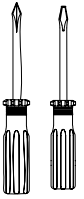
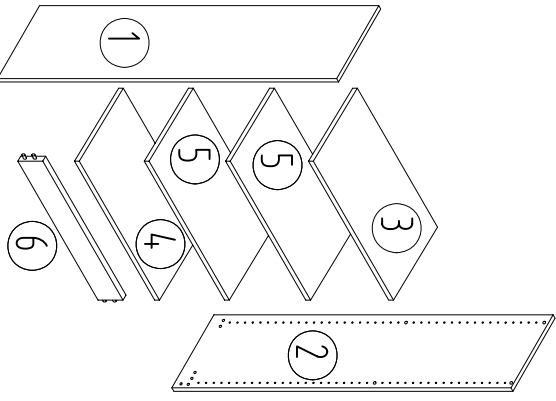
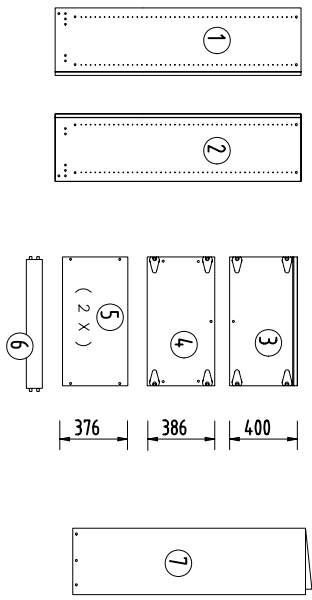

1

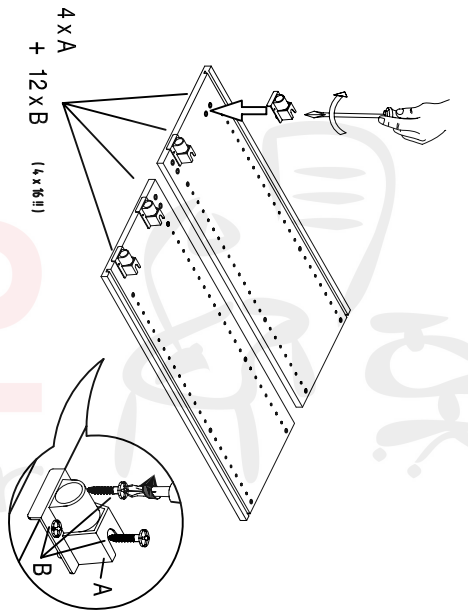

2

8 x C

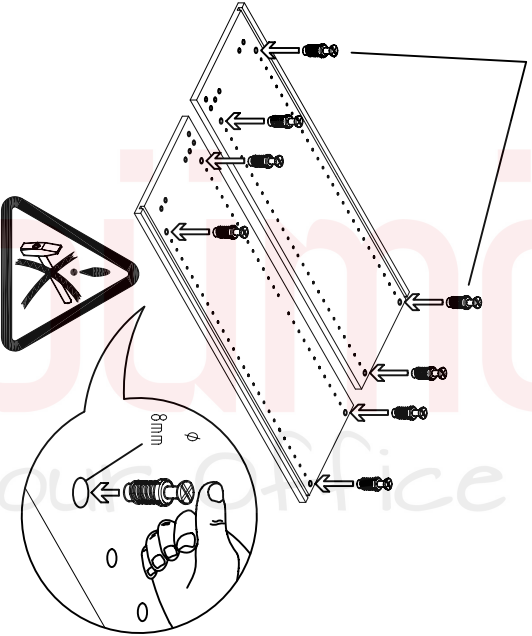

3

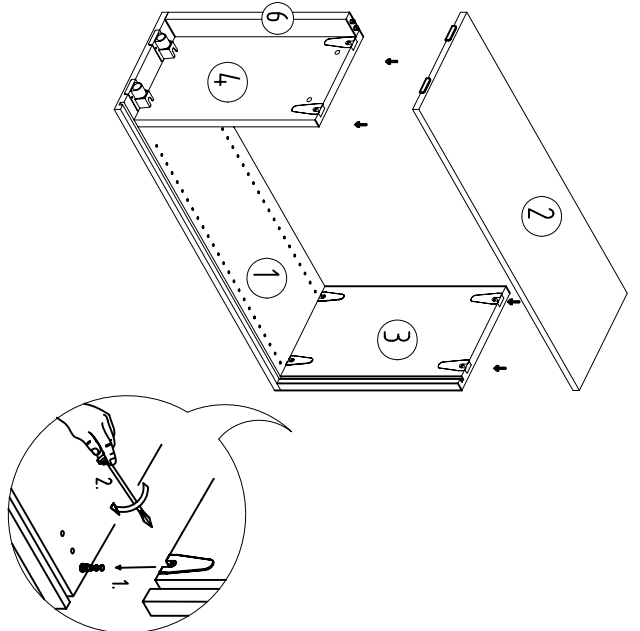

4

