

# GAVARRESA

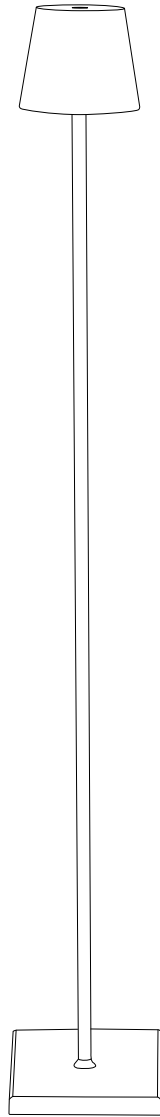

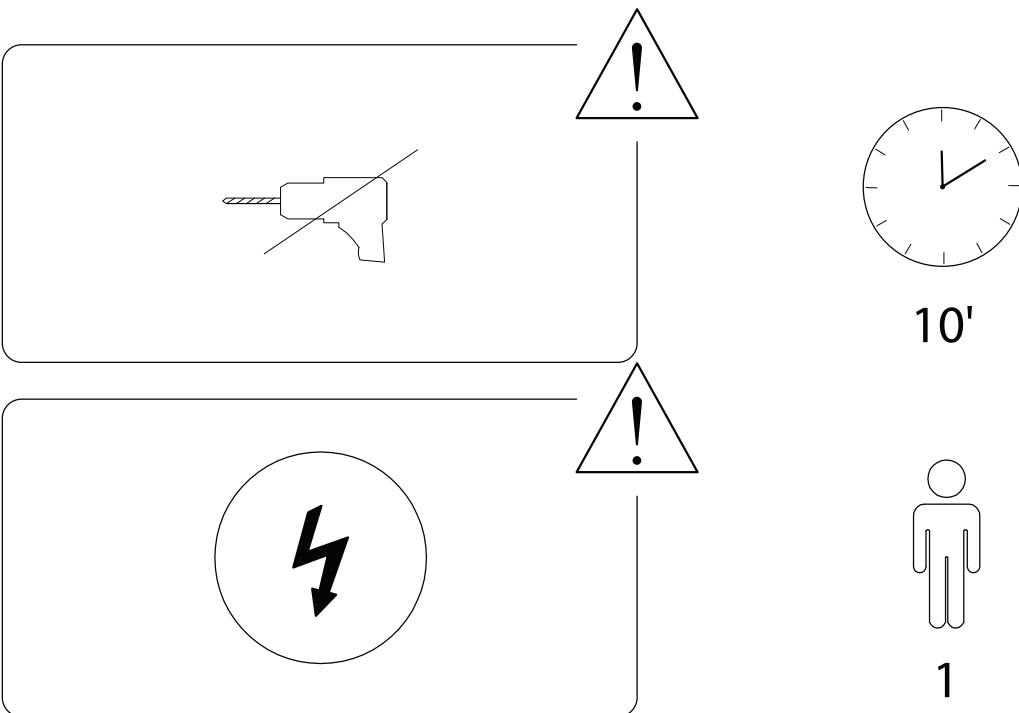

A

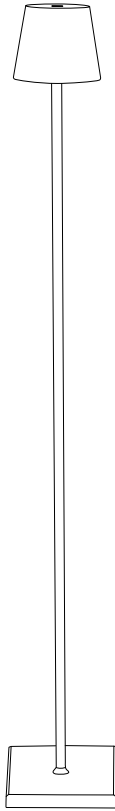
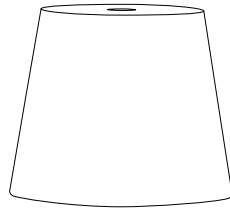

B x 4

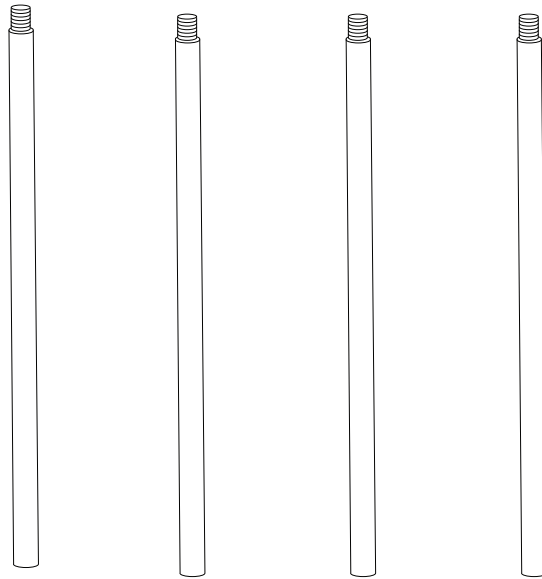

C

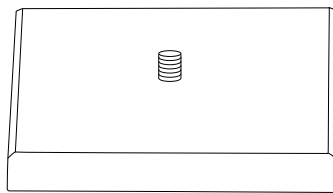

D

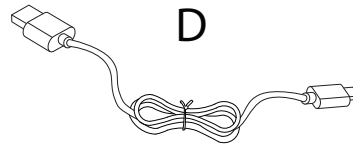

A

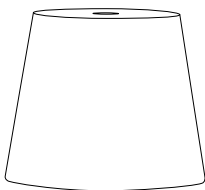

x 1

B



x 4

C

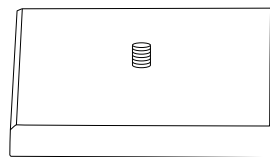

x 1

D

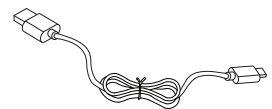

x 1

1

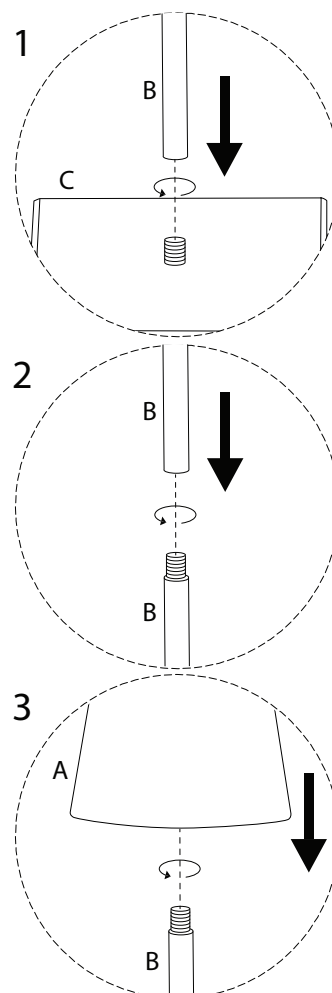
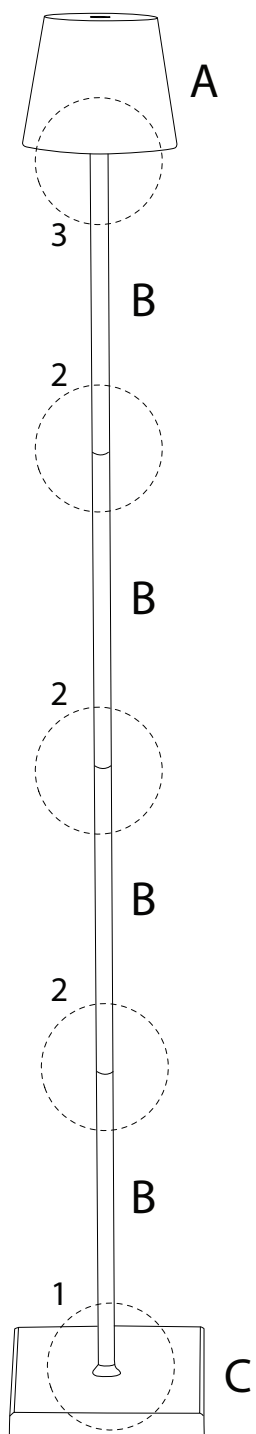
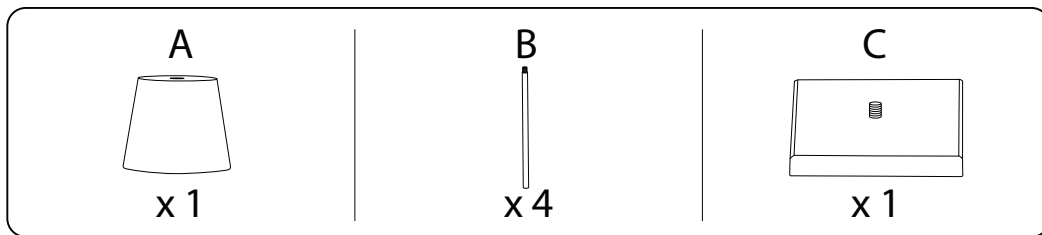

2

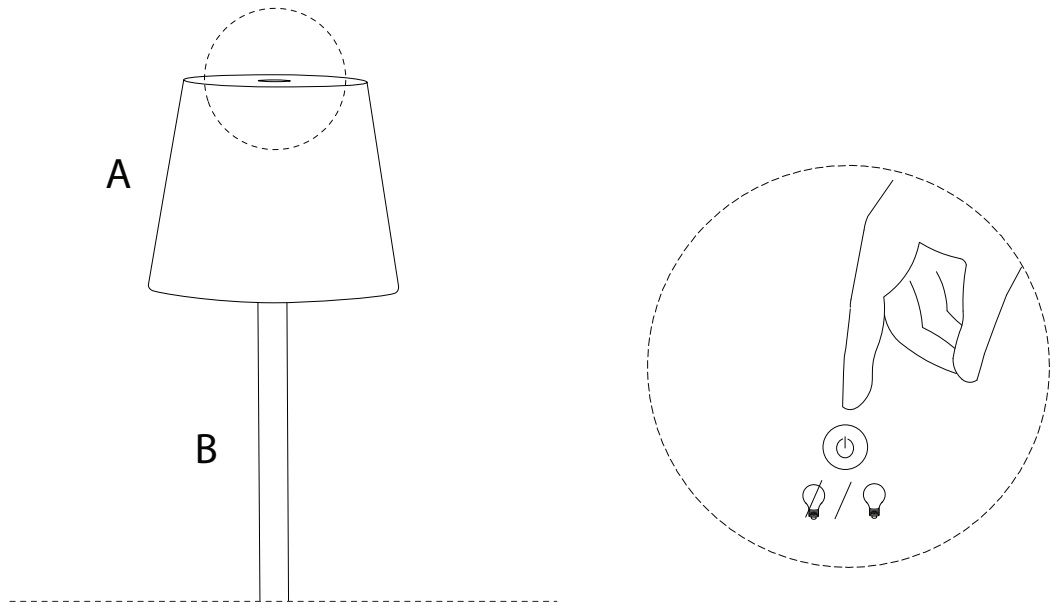

3

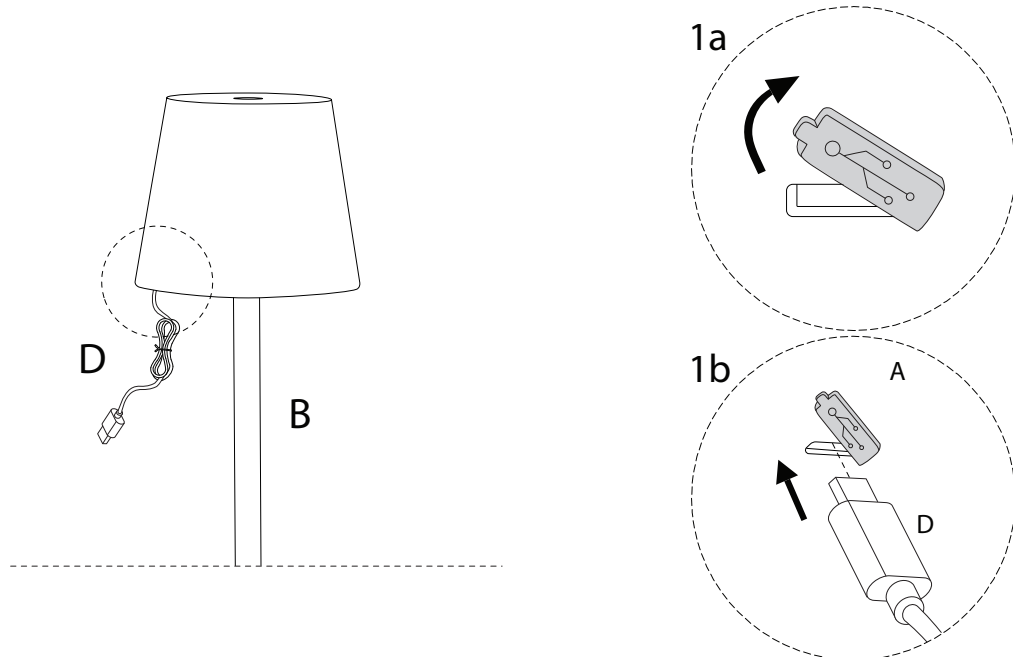
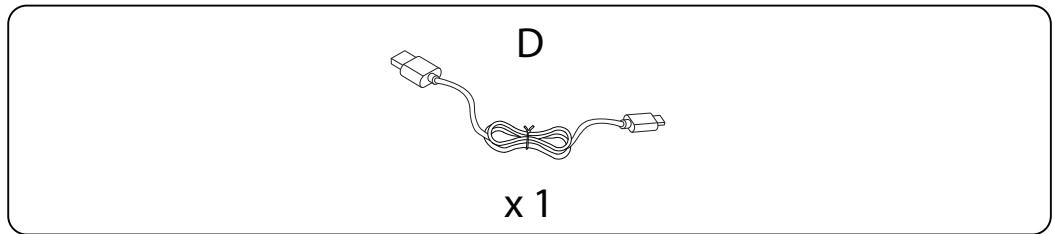

!

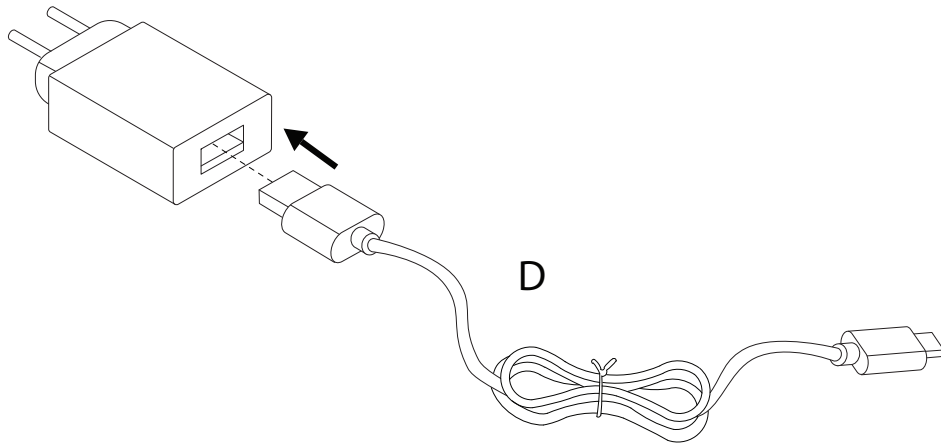

4

