

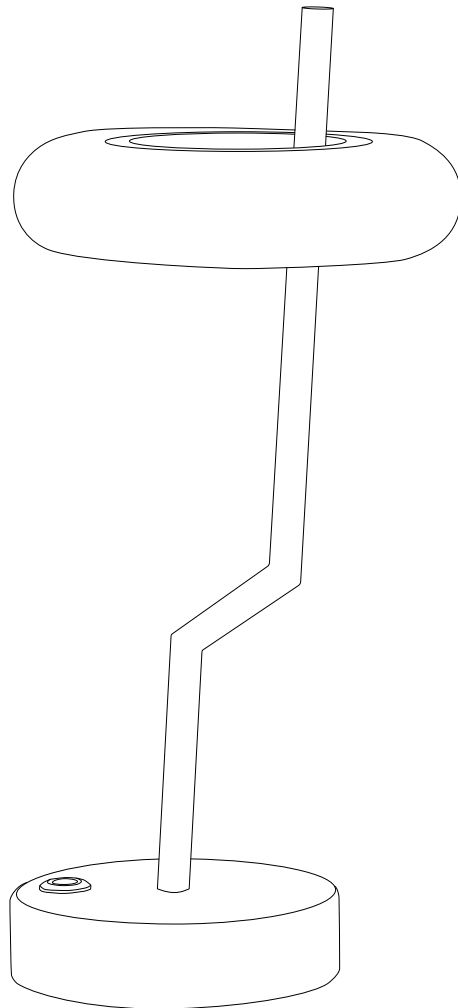

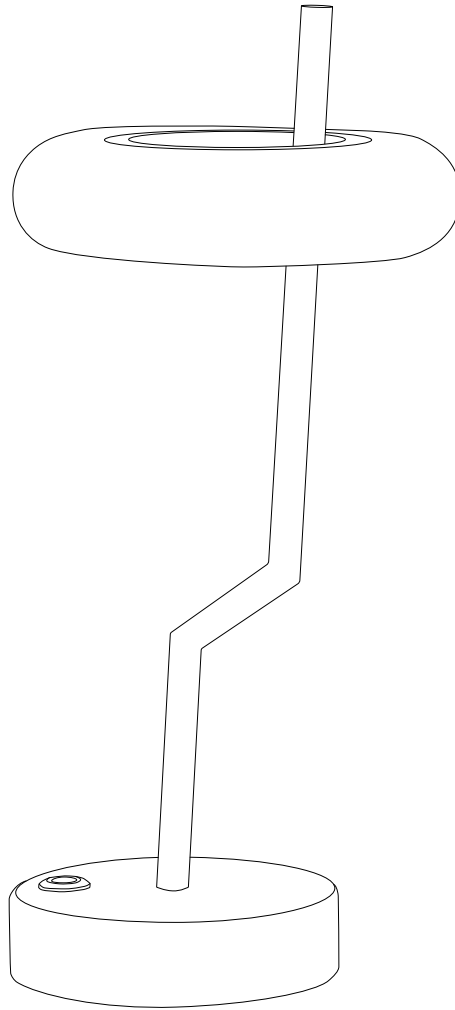

ALVIELA

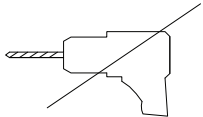

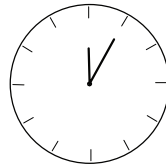
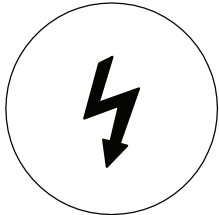

5'

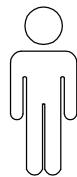
1

1/4

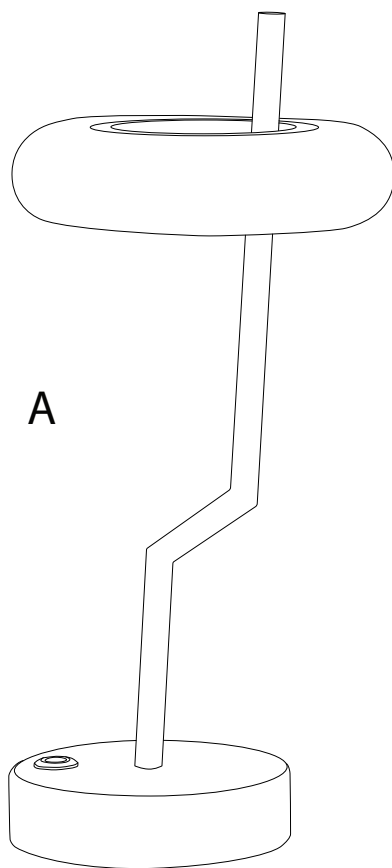

A

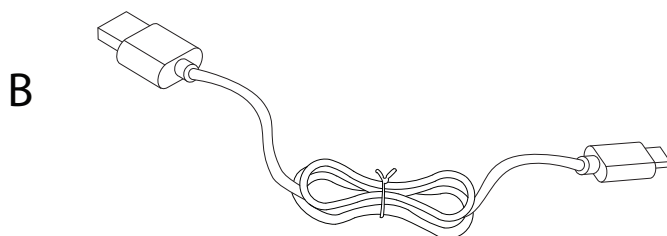

B

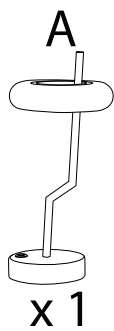

x 1

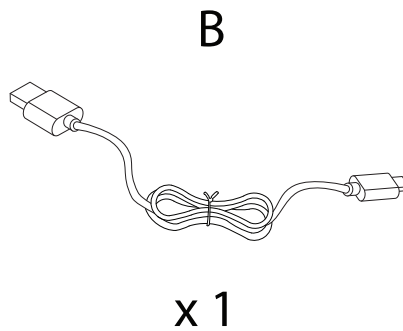

x 1

1

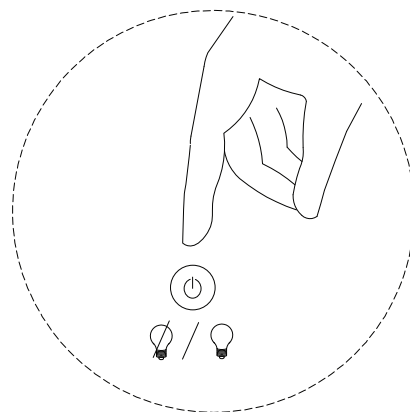
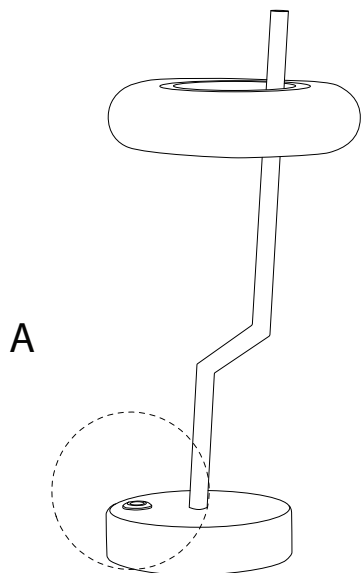

2

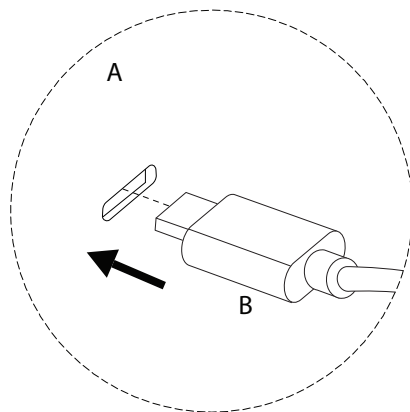
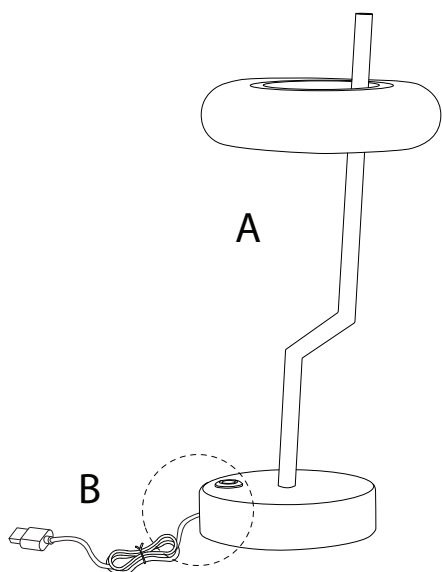
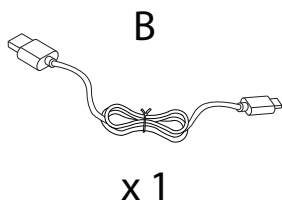

!

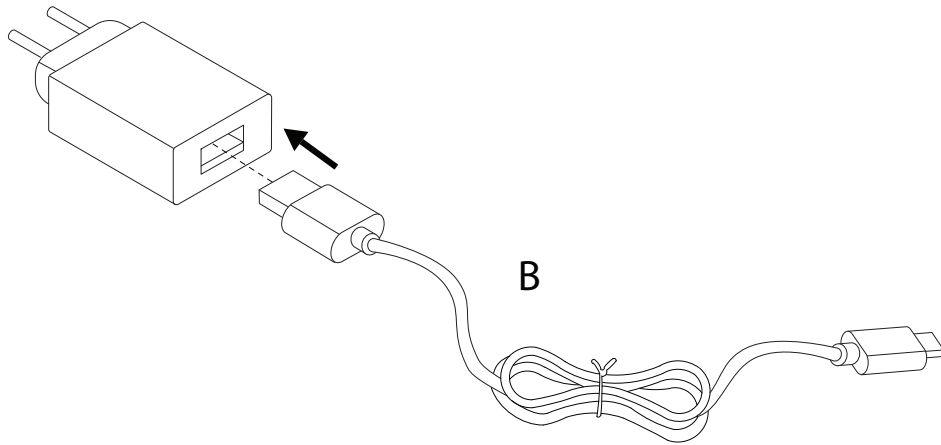

3

