

BOCONO

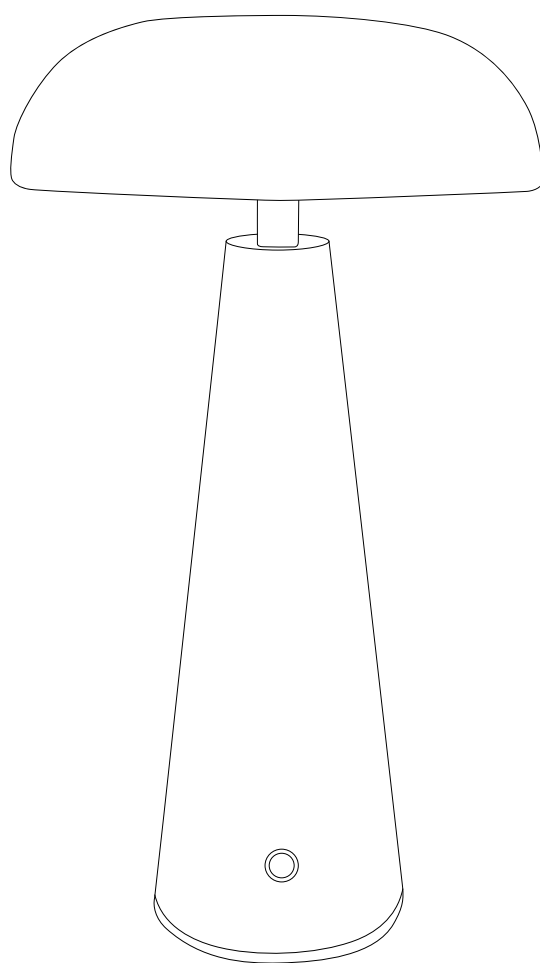

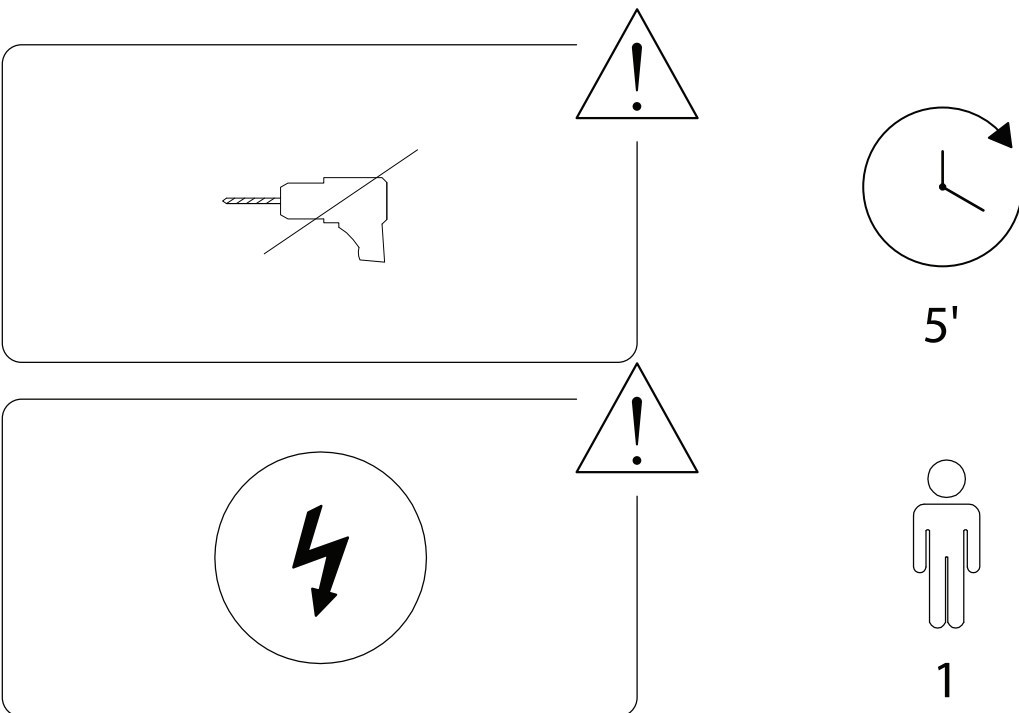

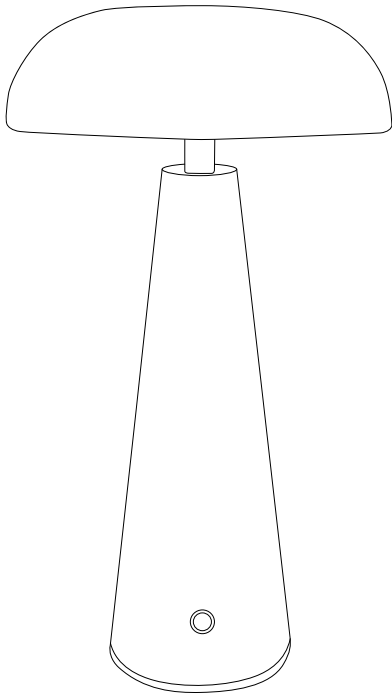
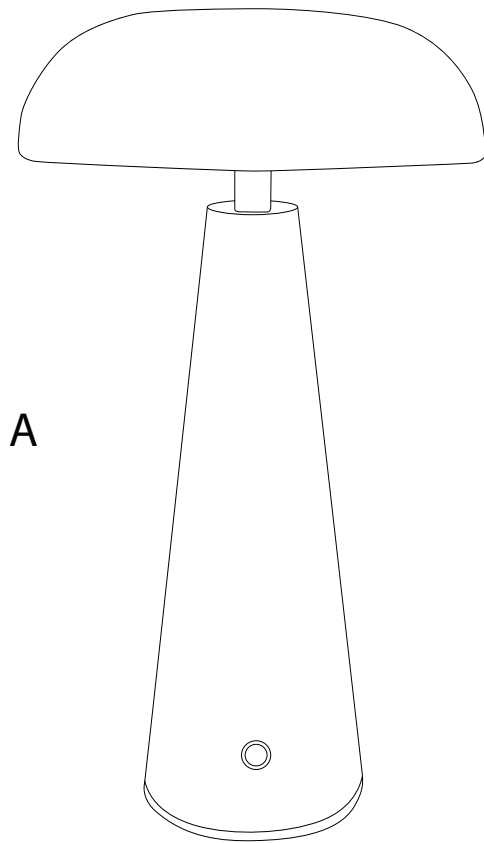

A

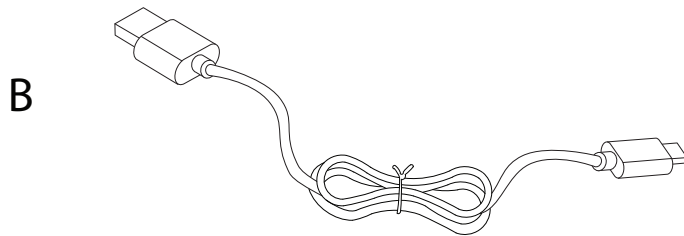

B

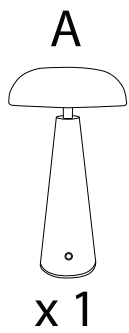

x 1

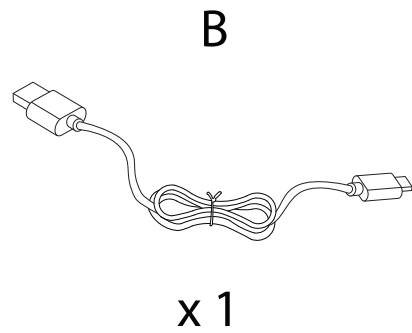

x 1

1

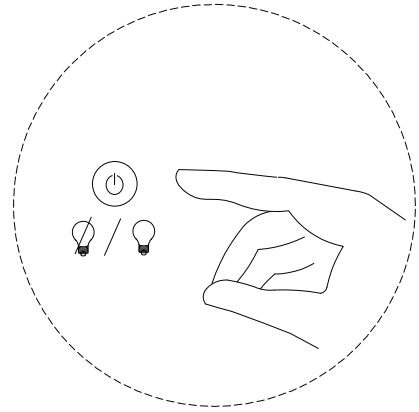
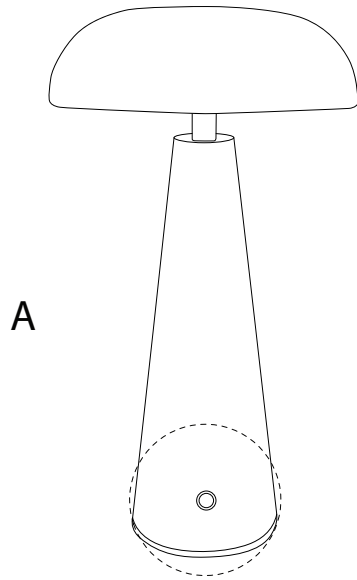

2

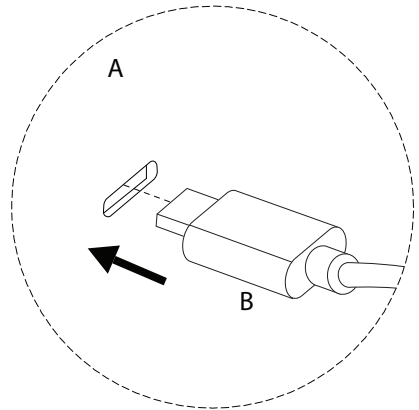
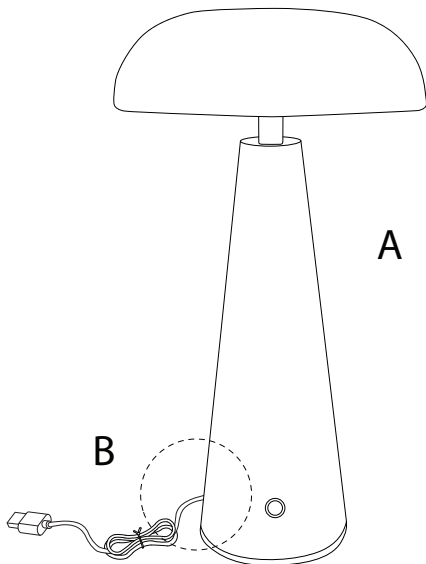
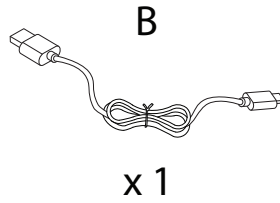

!

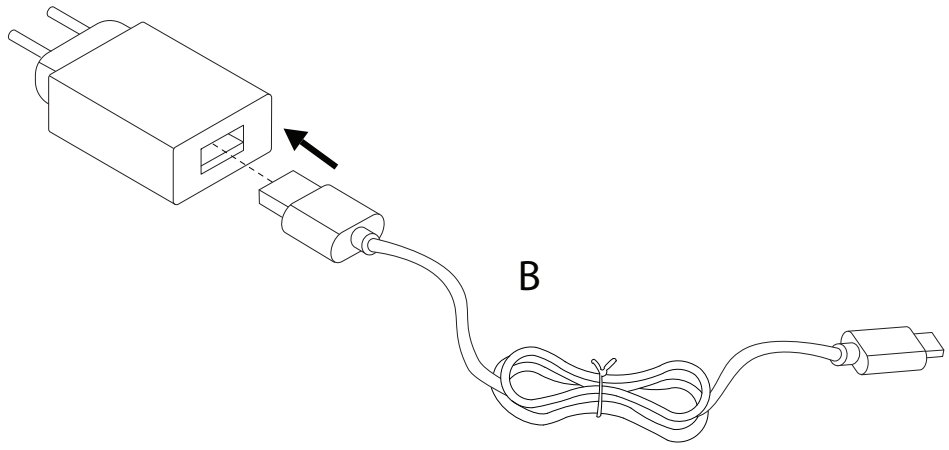

3

