

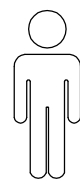



15'

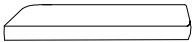
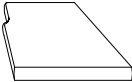
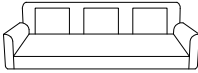

2

A	B	C	D	E	F
					
x 3	x 1	x 1	x 1	x 1	x 8

A x 3

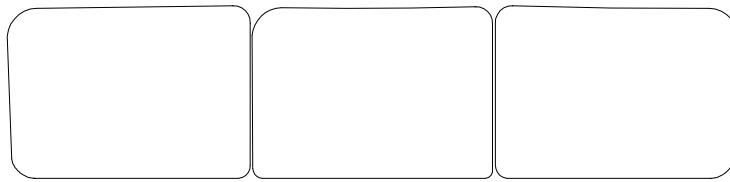

B



C

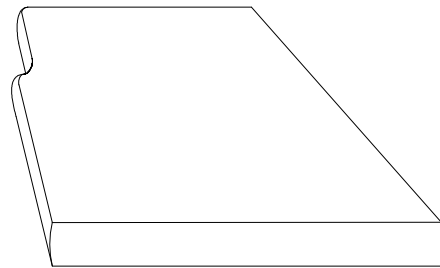

D

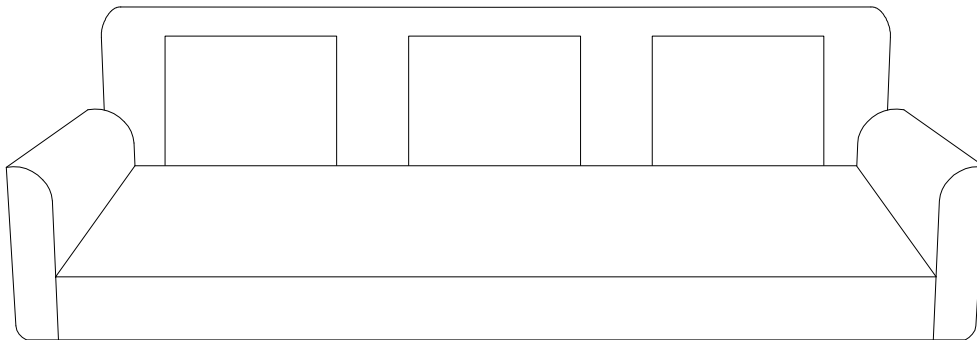

F x 8

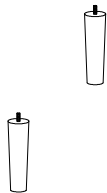

E

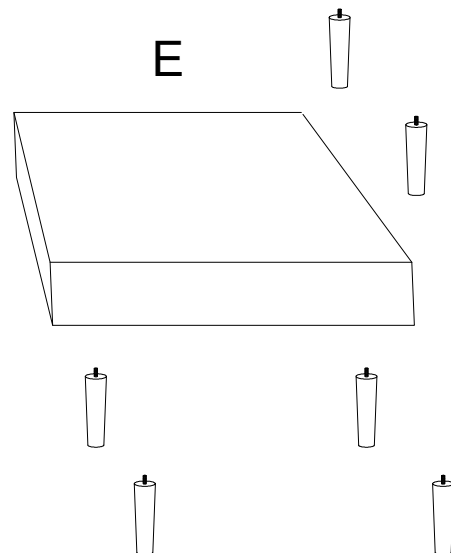

1

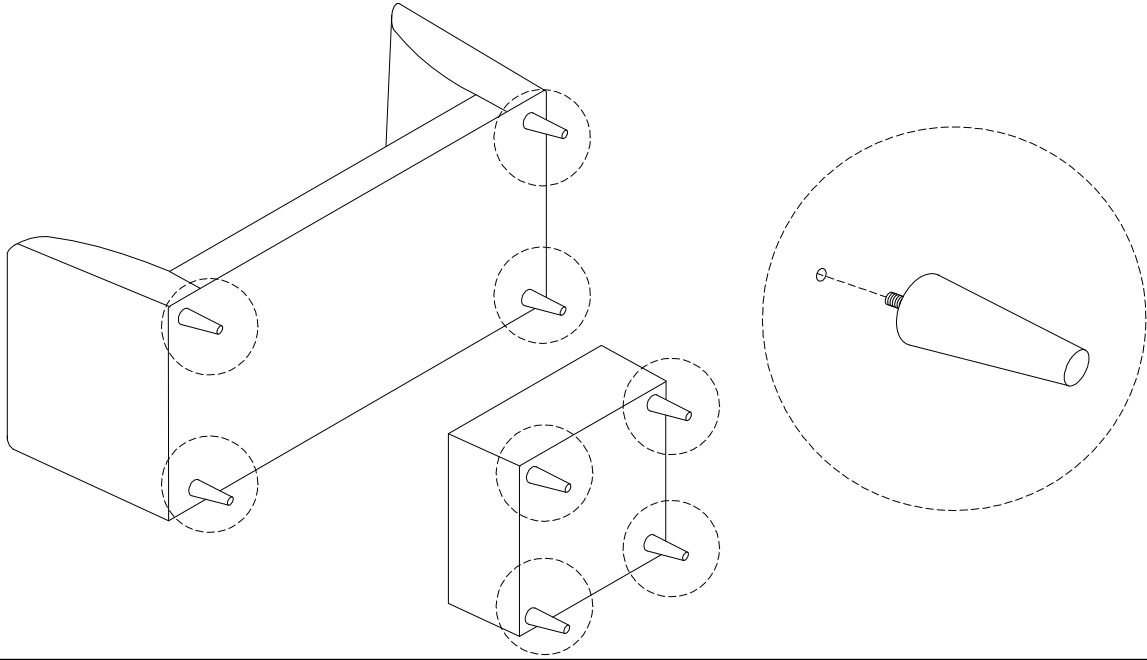
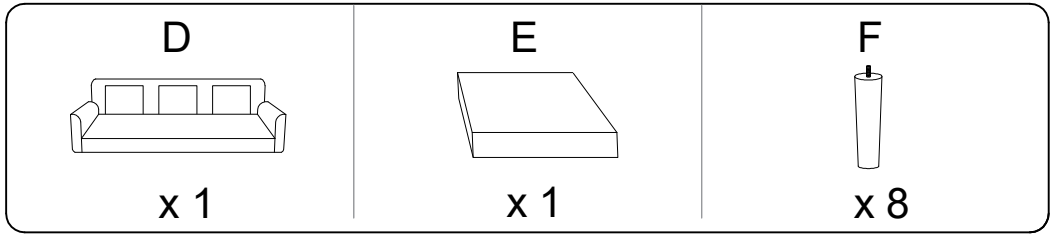

2

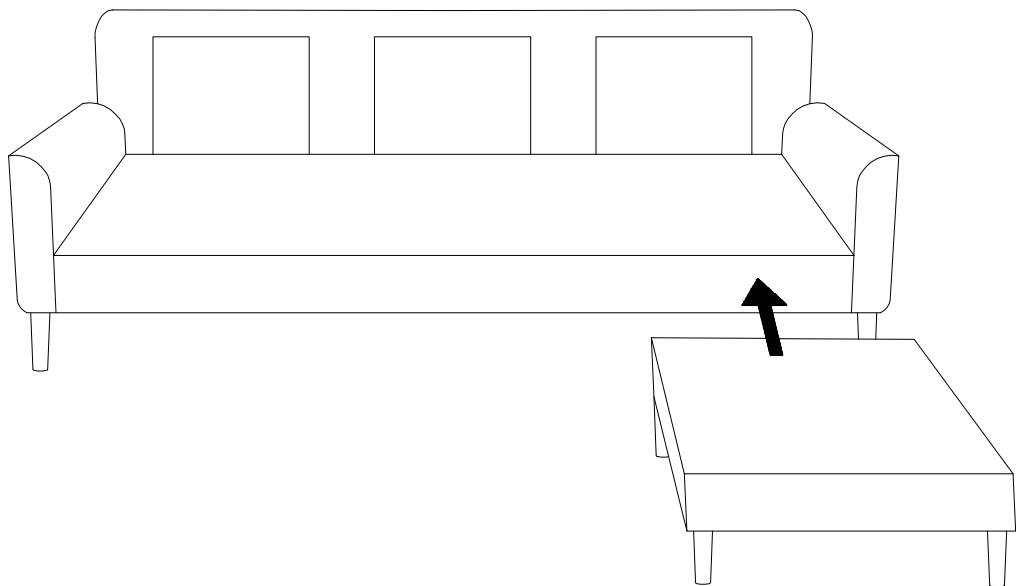

3

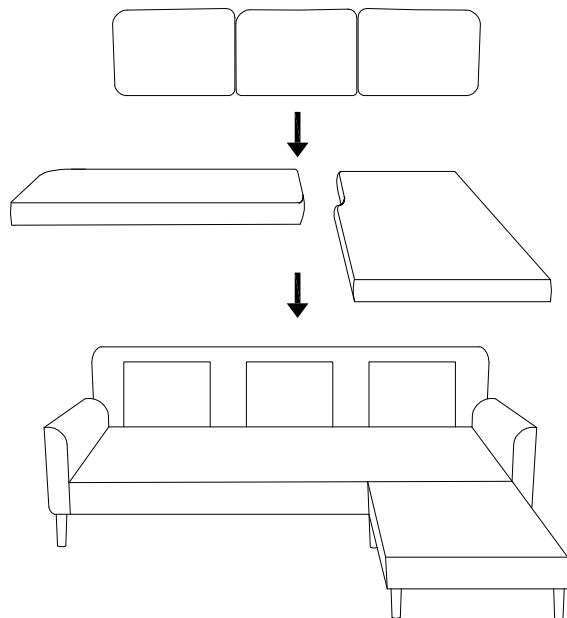
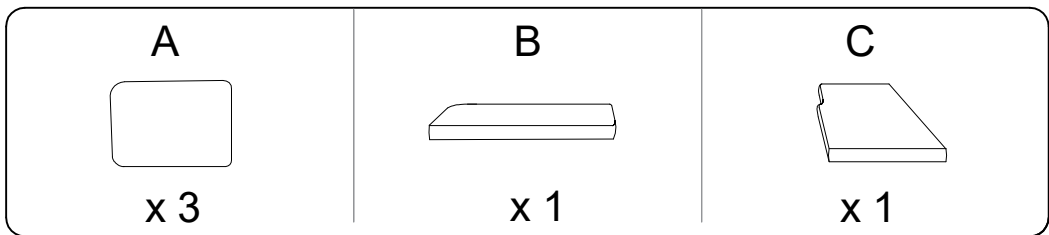

!

