

STEELSON

Metallkommode 'Zandor' 3x2

Metal dresser 'Zandor' 3x2



WICHTIG - SORGFÄLTIG LESEN - FÜR SPÄTERE VERWENDUNG AUFBEWAHREN

IMPORTANT - PLEASE READ CAREFULLY - KEEP FOR FUTURE REFERENCE

Sehr geehrte Kundin, sehr geehrter Kunde,

wir freuen uns, dass Sie sich für diesen hochwertigen Artikel entschieden haben. Wir haben diesen Artikel mit großer Sorgfalt hergestellt.

Um Ihnen unnötige Mühen zu ersparen, **lesen Sie zunächst die gesamte Aufbauanleitung sorgfältig durch**. Kontrollieren Sie die Vollständigkeit der mitgelieferten Teile und sehen Sie sich die Abbildungen genau an, bevor Sie mit der Montage beginnen. Bei unsachgemäßer Bedienung oder Montage und insbesondere bei Veränderungen der Konstruktion erlischt der Garantieanspruch.

Dear clients,

we are glad that you have chosen this premium product. We have manufactured this item with greatest care.

To spare you unnecessary effort, **carefully read the complete assembly instructions first**. Check whether you have all the parts and study the illustrations carefully before you start the assembly. Improper handling or assembly and especially construction alterations will void all warranty claims.

Aufbaupersonen

Persons needed for assembly



Die Montage muss unbedingt von 1 Erwachsenen durchgeführt werden.

The assembly must necessarily be executed by 1 adult.

Zusätzlich benötigtes Werkzeug

Additional necessary tools



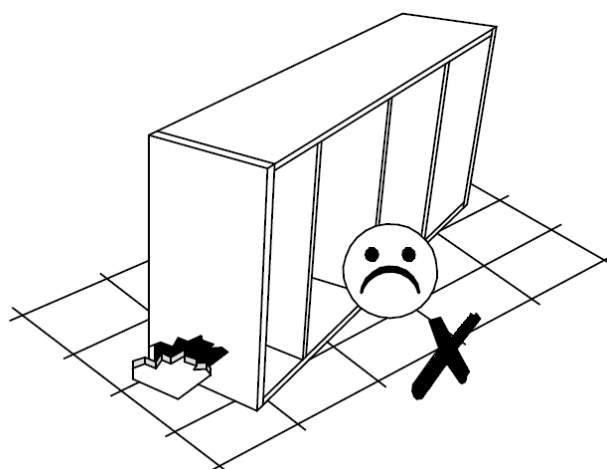
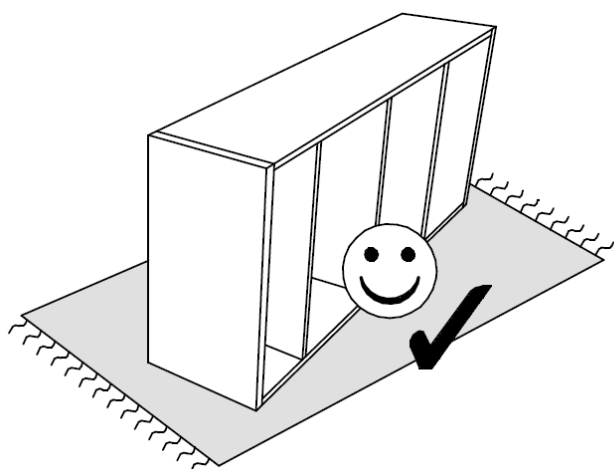





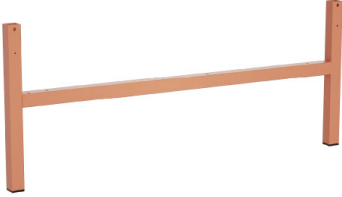
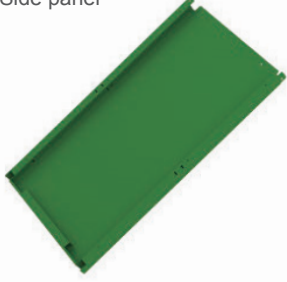
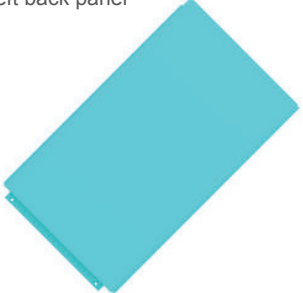

Kreuzschraubendreher
Screw driver

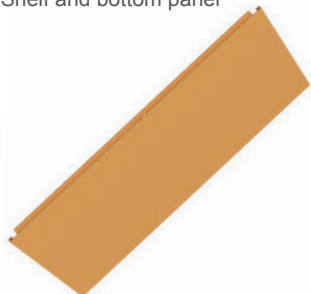

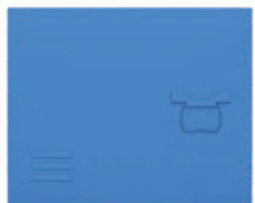
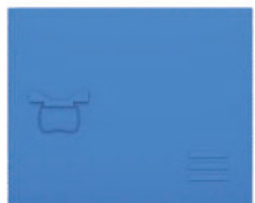

Schützen Sie Ihr Möbelstück vor Schäden, indem Sie auf einem Teppich arbeiten oder eine Decke auf den Boden legen.

Protect your your furniture from damage by working on a rug or placing a blanket on the floor.

Bauteile - Components

Bauteil - Bild Component - Picture	Bauteil - Bild Component - Picture	Bauteil - Bild Component - Picture
<p>A Bein Leg</p>  <p>2x</p>	<p>B Seitenwand Side panel</p>  <p>2x</p>	<p>C Linke Rückwand Left back panel</p>  <p>1x</p>
<p>D Rechte Rückwand Right back panel</p>  <p>1x</p>	<p>E Trägerstange Support bar</p>  <p>2x</p>	<p>F Regal- und Einlegeboden Shelf and bottom panel</p>  <p>3x</p>
<p>G Obere Abdeckplatte Top cover panel</p>  <p>1x</p>	<p>H Linke Tür Left door</p>  <p>3x</p>	<p>H Rechte Right door</p>  <p>3x</p>
<p>1 Bolzen, kurz Bolt, short</p>  <p>2x</p>	<p>2 Schraube Screw</p>  <p>14x</p>	<p>3 Fachbodenträger Shelf holder</p>  <p>8x</p>
<p>4 Unterlegscheibe Flat washer</p>  <p>6x</p>	<p>5 Höhenverstellbarer Fuß Height-adjustable foot</p>  <p>4x</p>	<p>6 Bolzen, lang Bolt, long</p>  <p>4x</p>

Bauteile - Components

Bauteil - Bild Component - Picture	Bauteil - Bild Component - Picture	Bauteil - Bild Component - Picture
<p data-bbox="97 235 244 286">7 Magnet Magnet</p>  <p data-bbox="507 546 544 573">6x</p>	<p data-bbox="584 235 770 286">8 Federbolzen Spring bolt</p>  <p data-bbox="983 546 1019 573">2x</p>	<p data-bbox="1062 235 1265 286">9 Gummiauflage Rubber pad</p>  <p data-bbox="1465 546 1501 573">6x</p>

Beachten Sie bitte:

Bitte benutzen Sie für die Montage den beiliegenden Inbusschlüssel. Um Beschädigungen am Produkt zu vermeiden raten wir von der Benutzung eines Akkuschraubers ab! Nur original Zubehör- und Ersatzteile vom Hersteller oder Lieferanten verwenden. Verbinden Sie alle Teile zunächst nur lose miteinander. Ziehen Sie erst nach Beendigung der Montage alle Schraubverbindungen fest an. Das erleichtert den Aufbau und vermeidet, dass der Artikel wackelt!

Please note:

Please use only the enclosed hex key for the assembly. To avoid damaging the product we advise against using an electric screwdriver! Use only original accessories and spare parts from the producer or from the providers. First, screws the components loosely together. Tighten the screws only after having finished the assembly. This will facilitate the assembly and will ensure the stability of the article!

Montage - Assembling

1

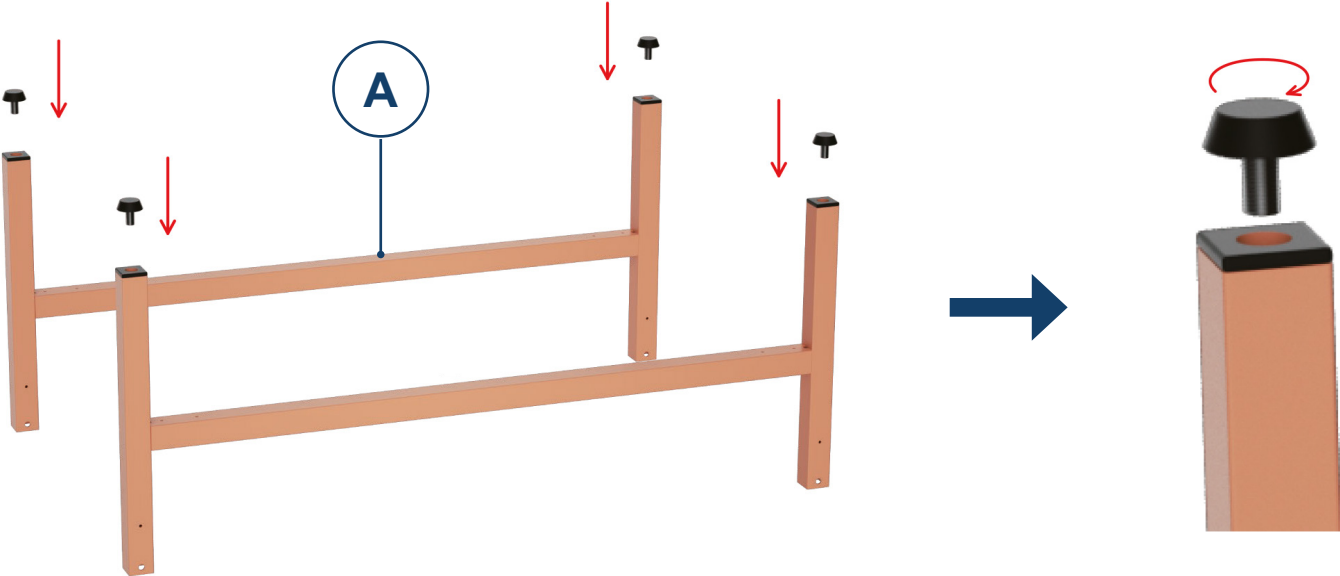
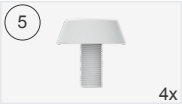

2

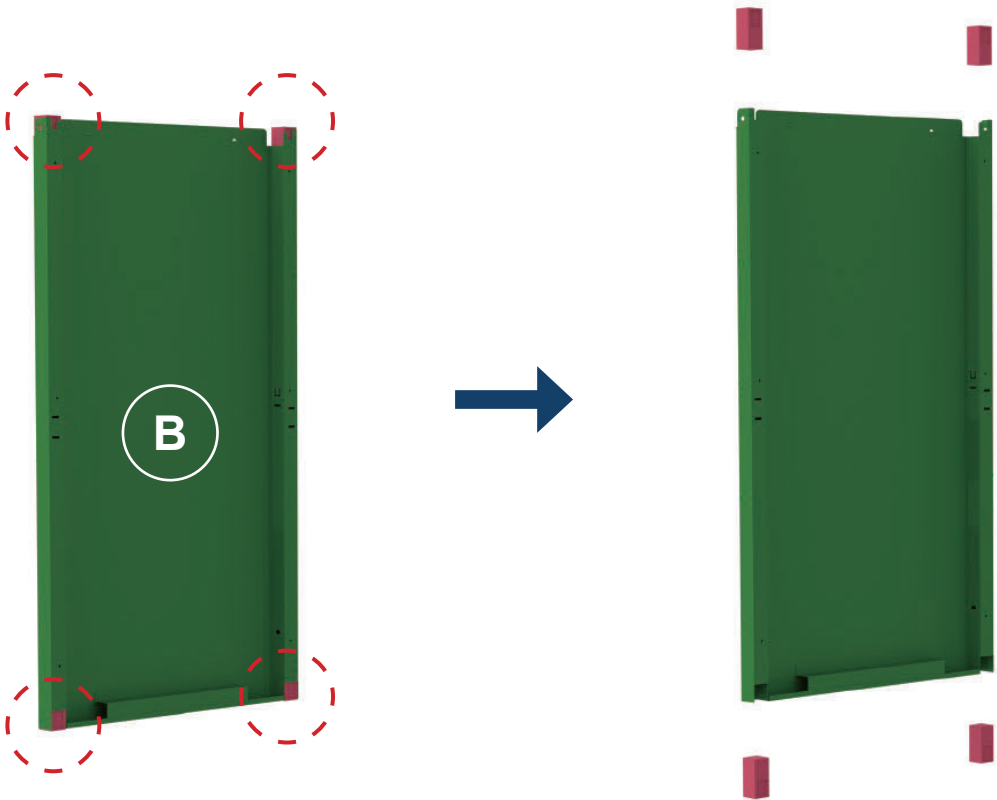

3



4



Hinweis: Achten Sie darauf, dass sich die Löcher von Teil A an der Innenseite für die Montage der Rückwände und an der Außenseite für die Montage der Türen befinden.
Note: Make sure that the holes in part A are on the inside for mounting the back panels and on the outside for mounting the doors.

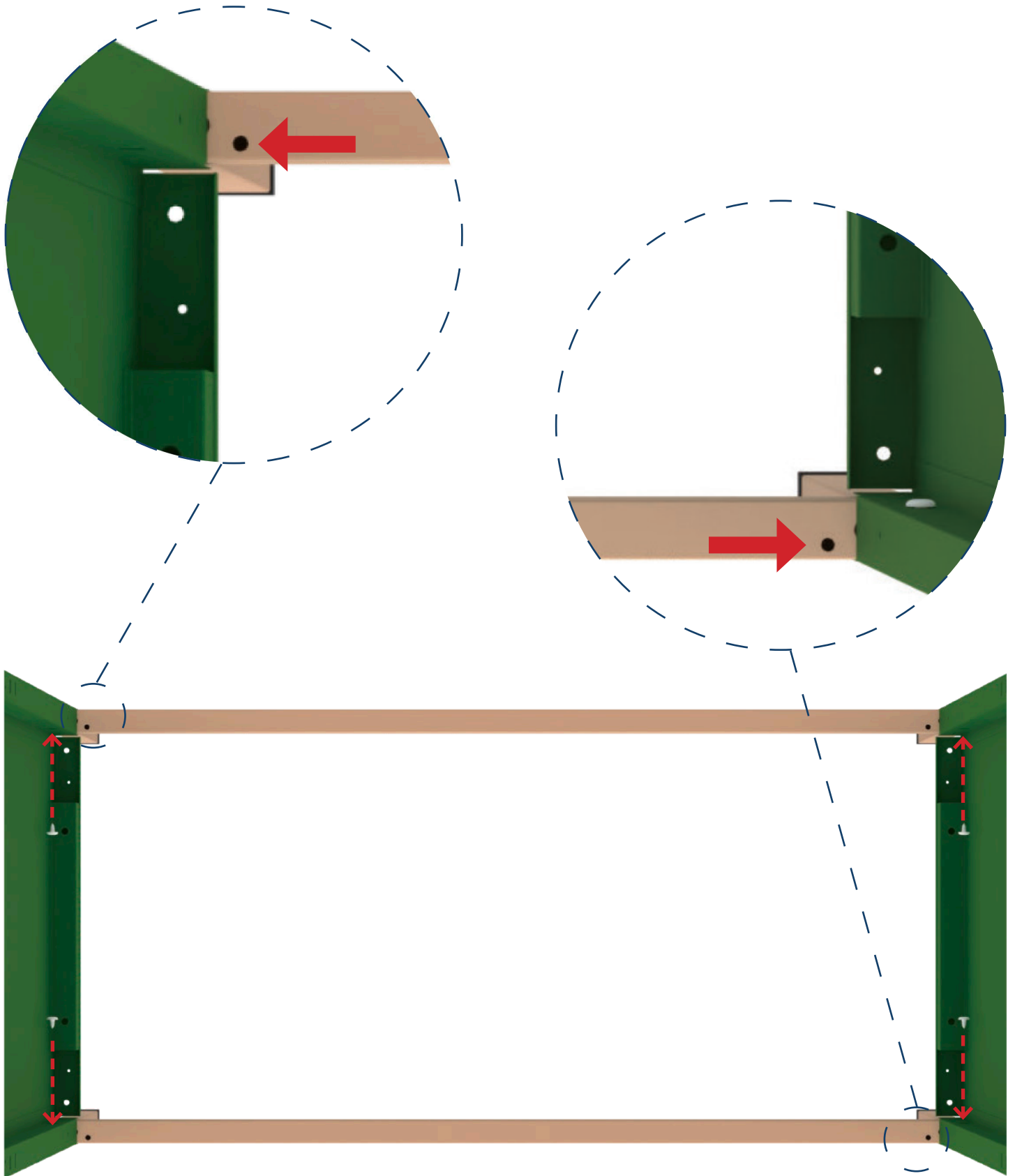
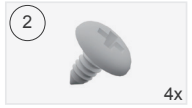



6

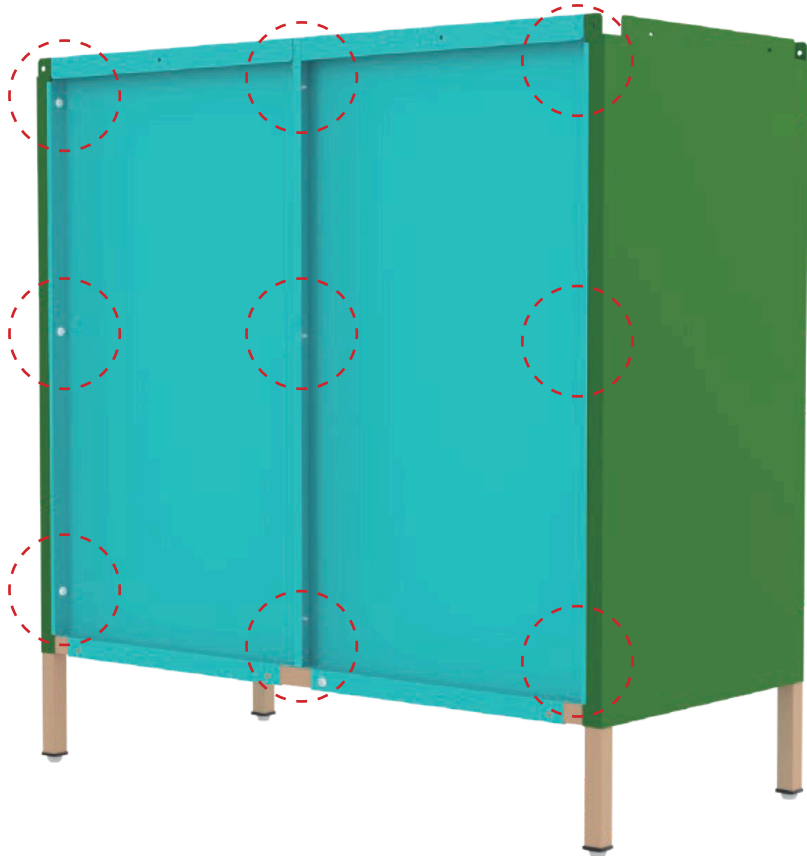

7

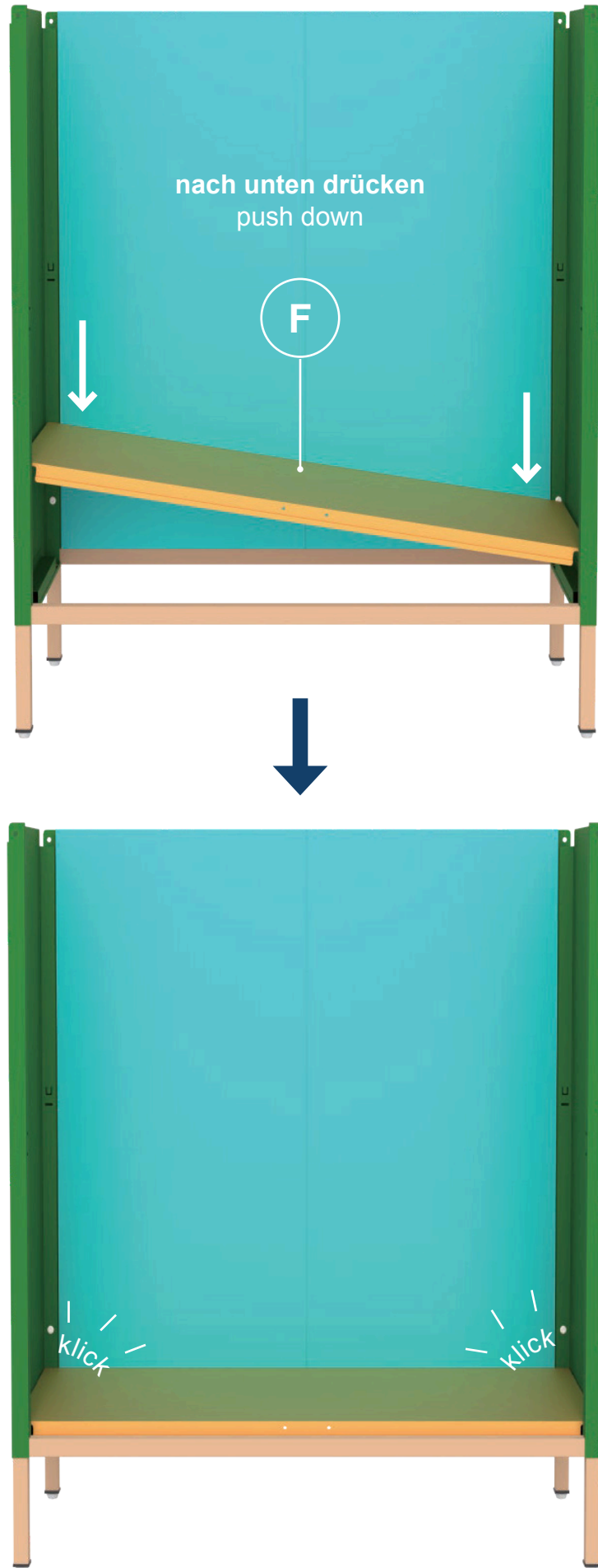

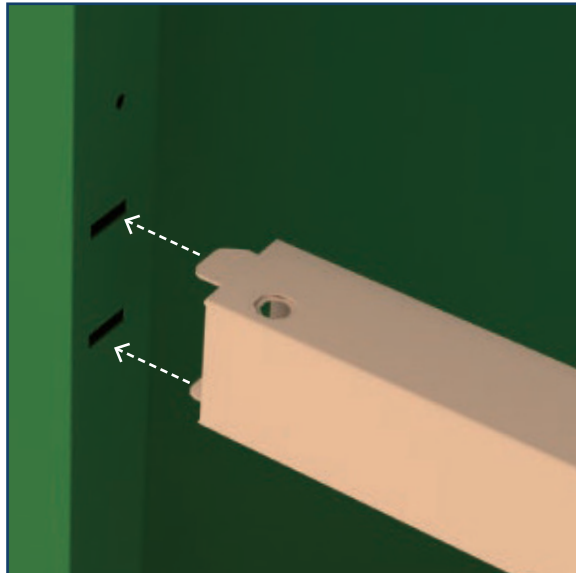
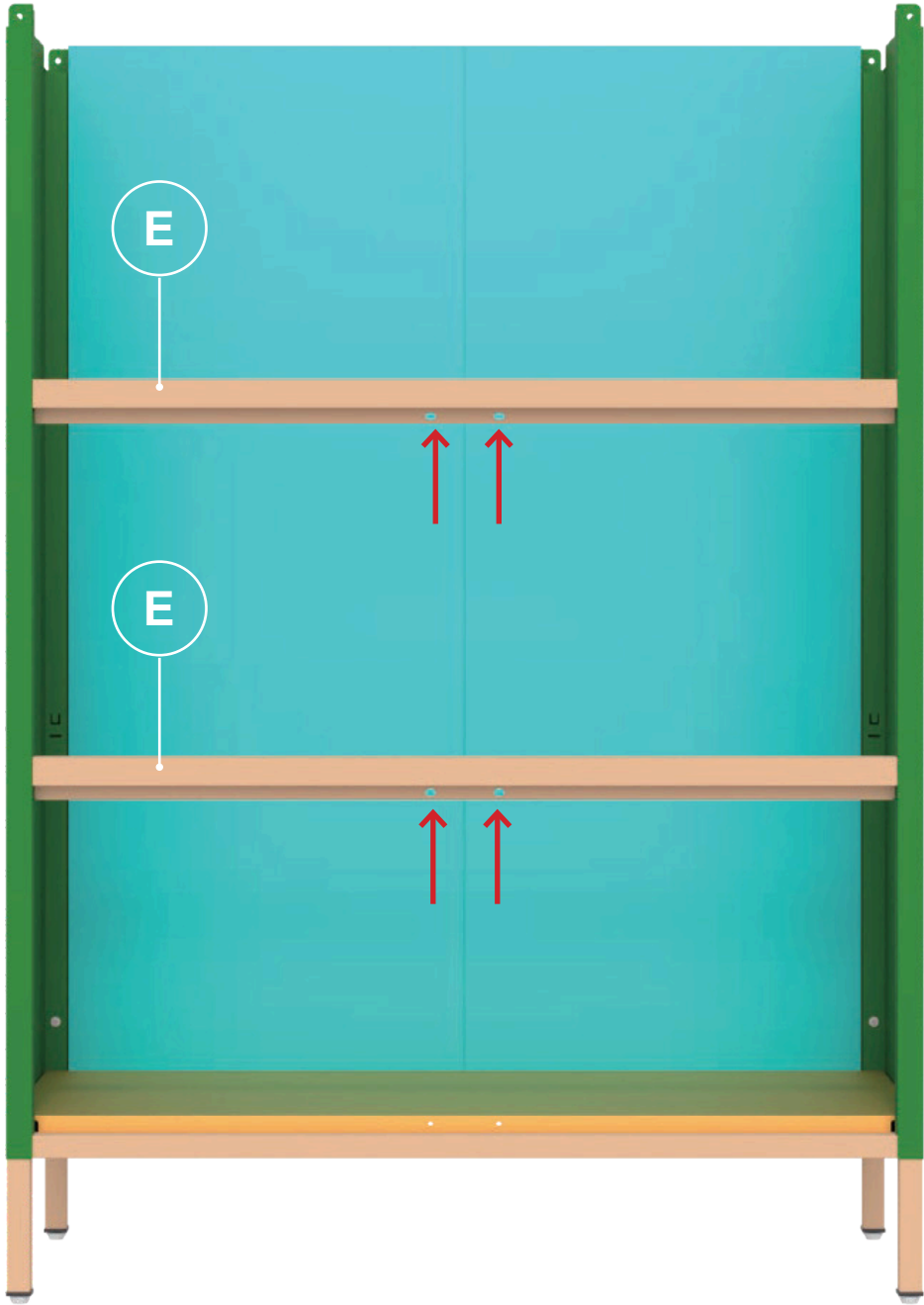

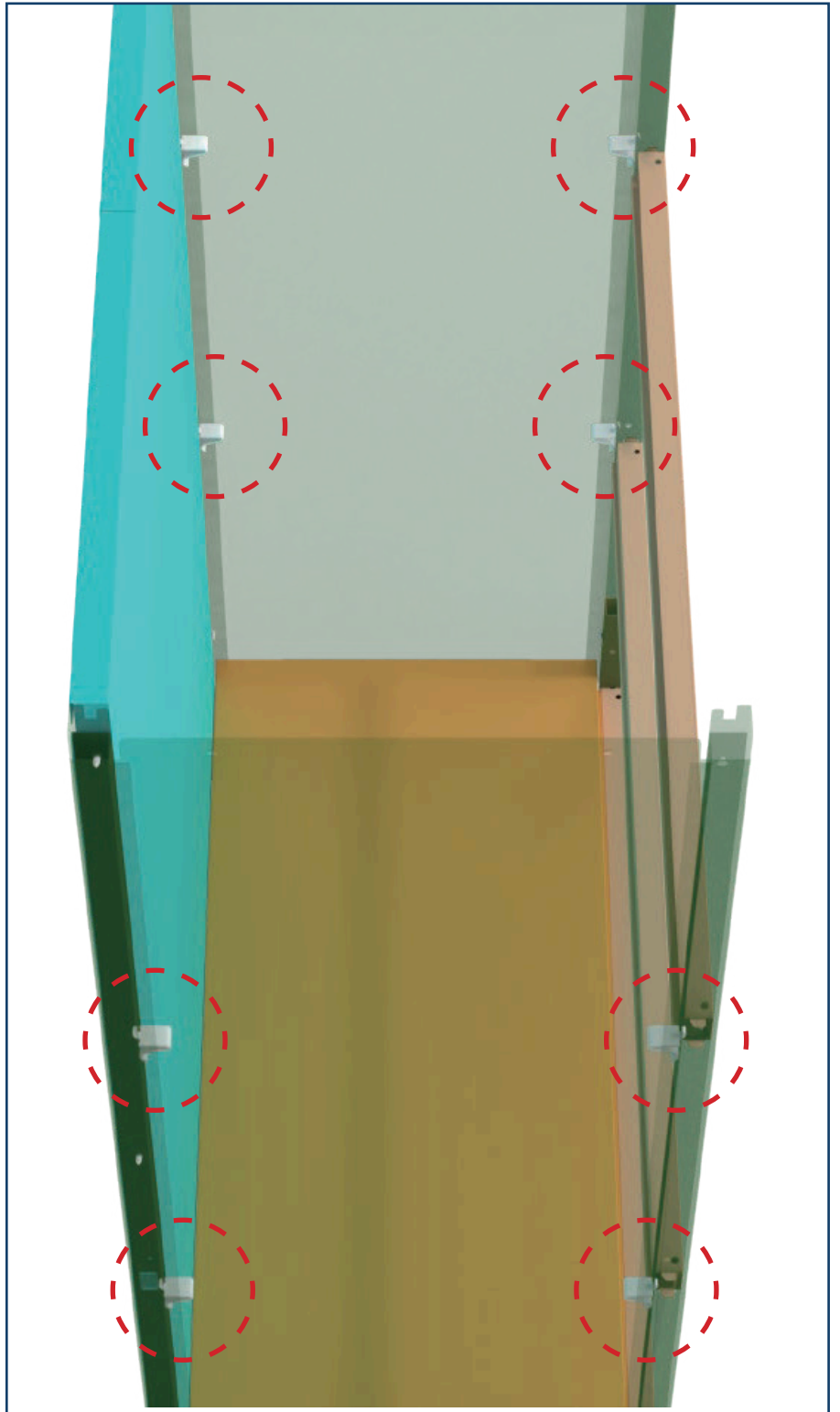
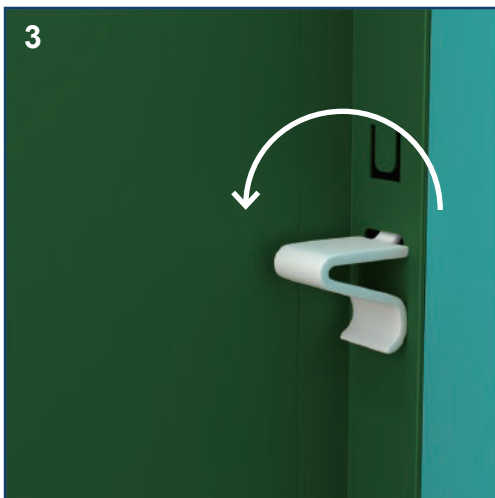
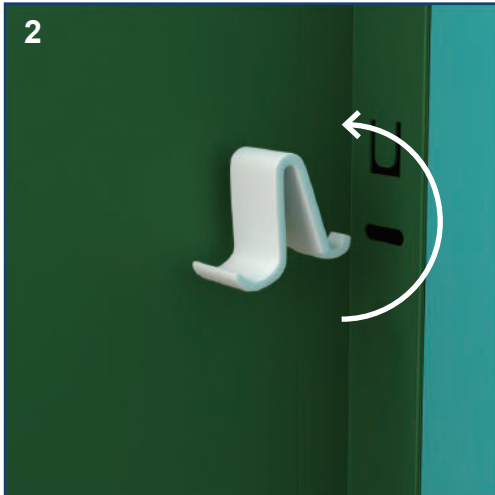
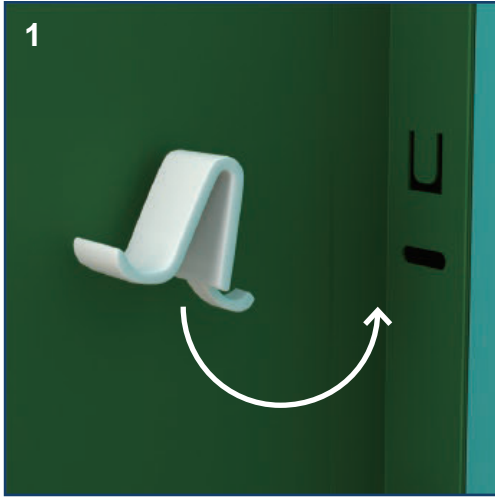

10

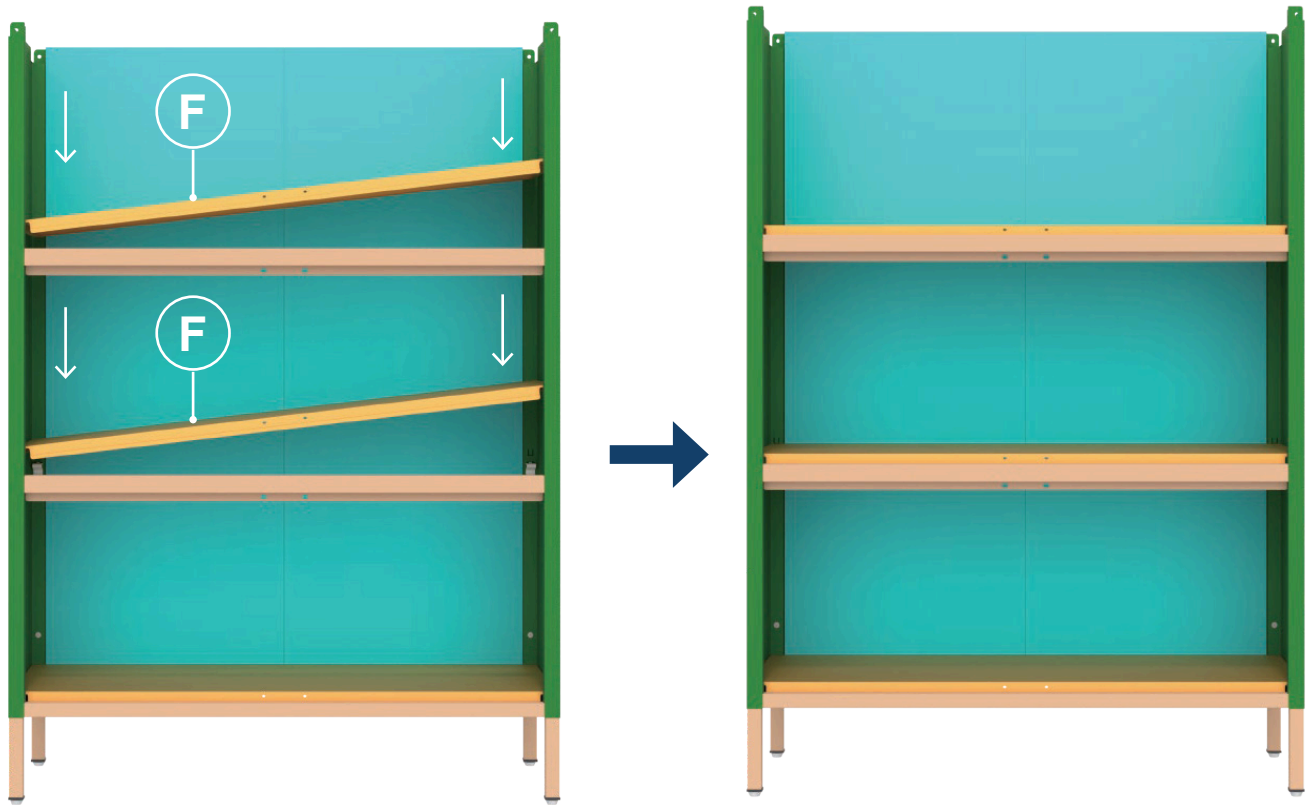

11

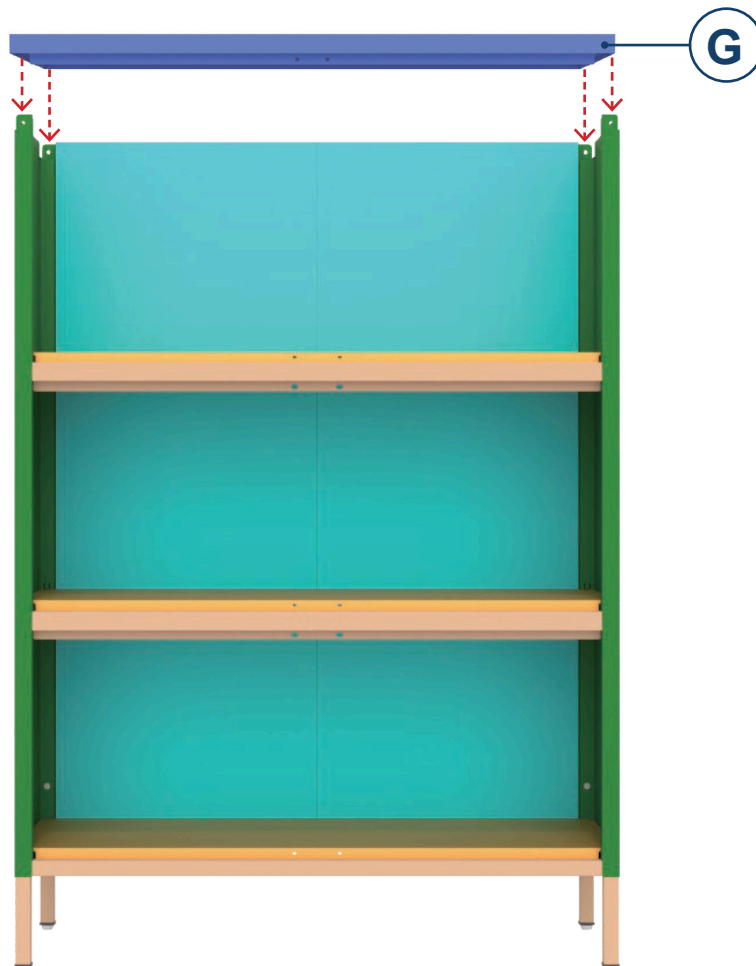

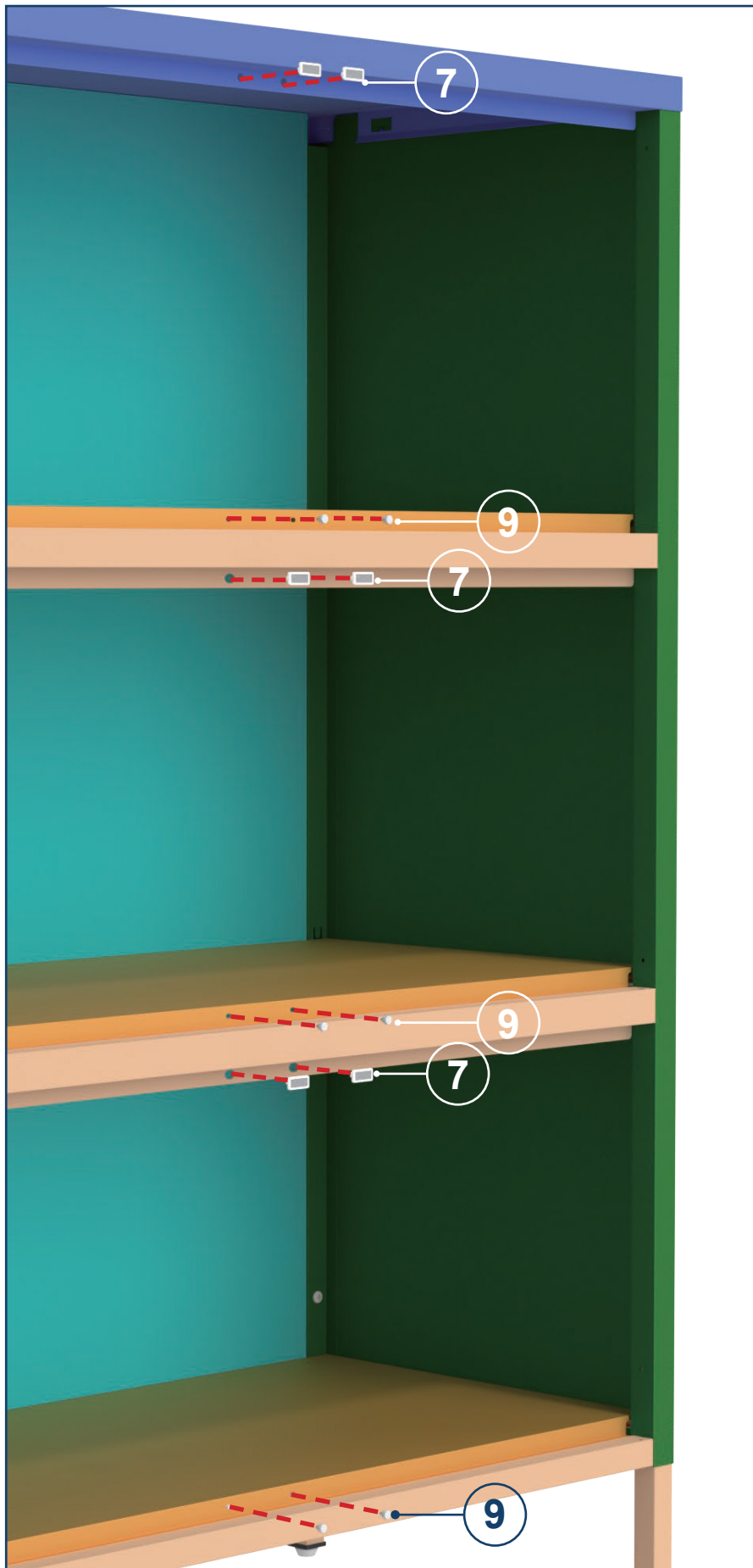

13

2x

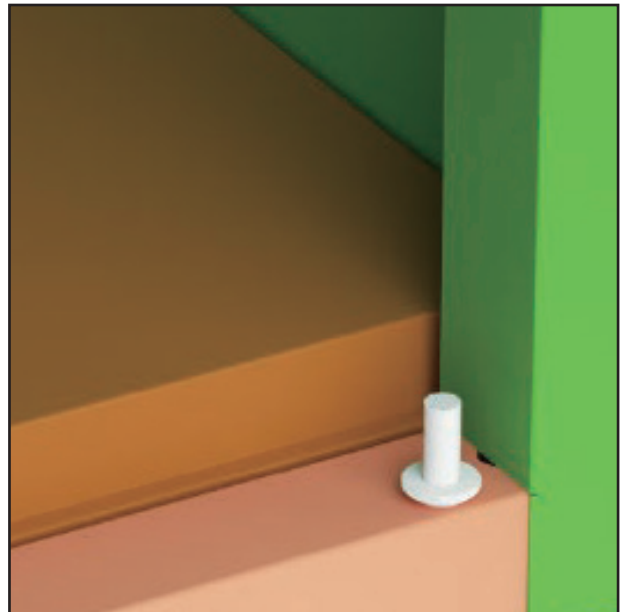
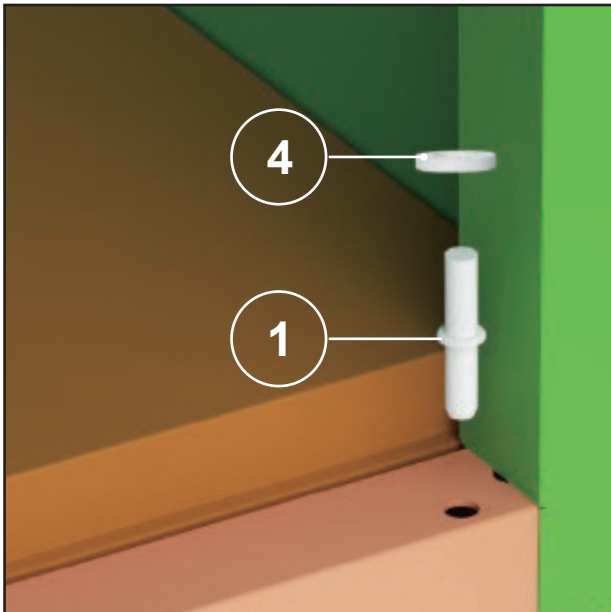
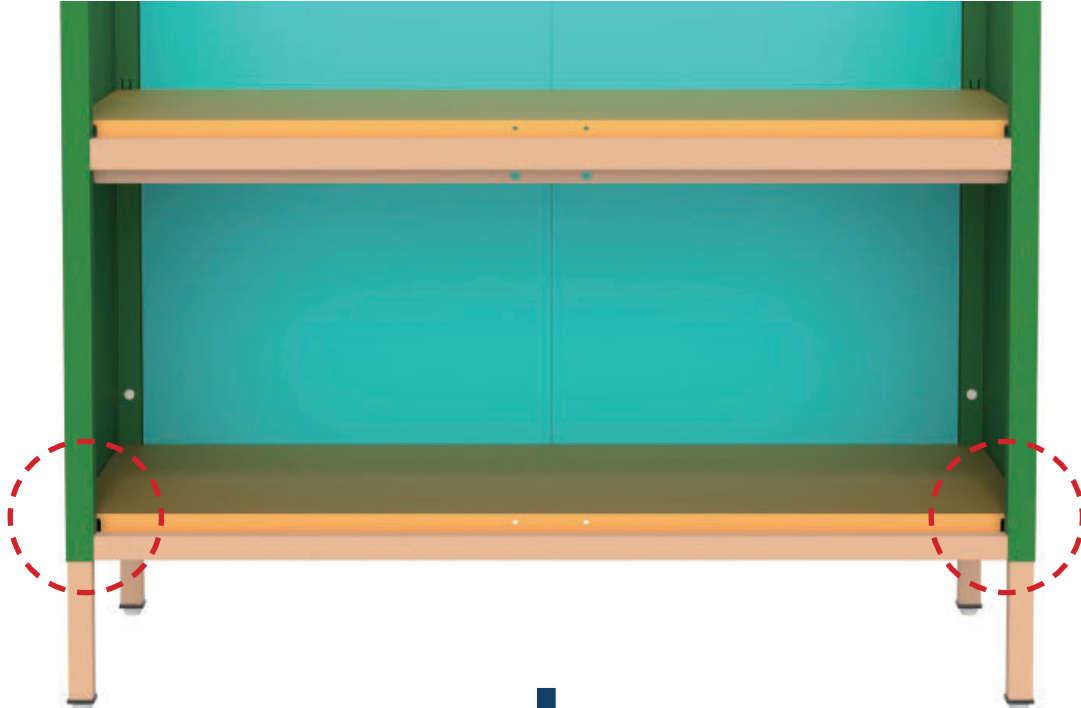

14

2x

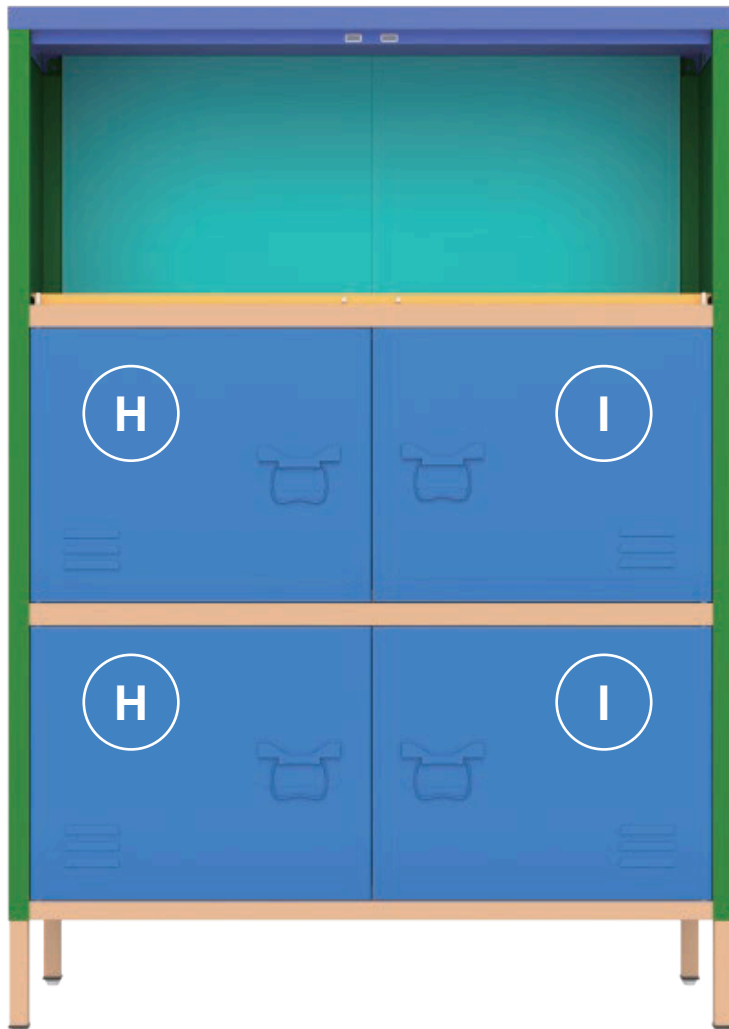
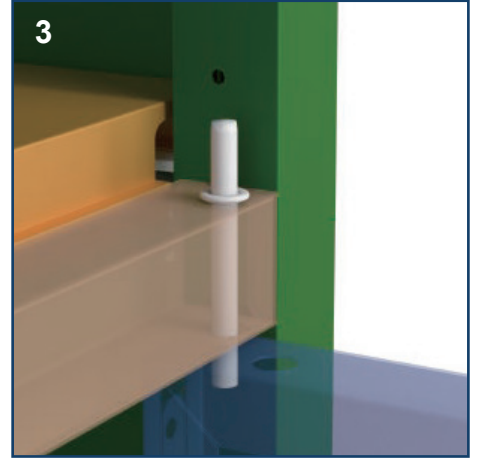
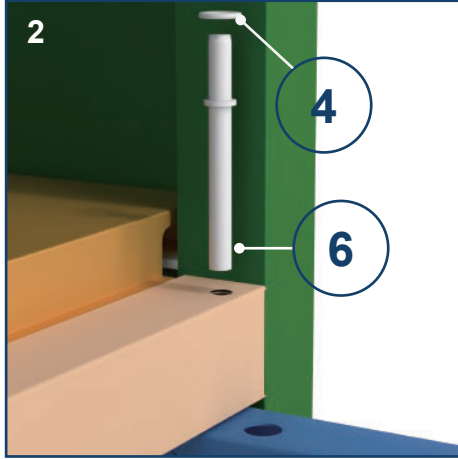
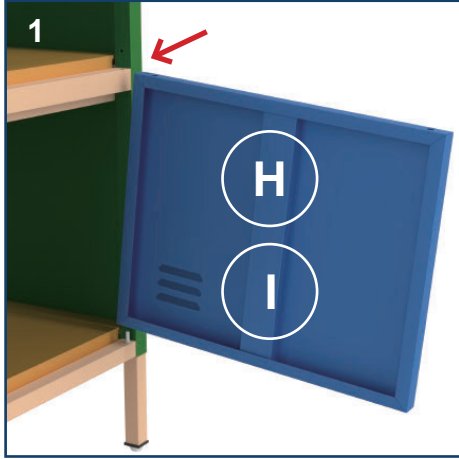

15

2x

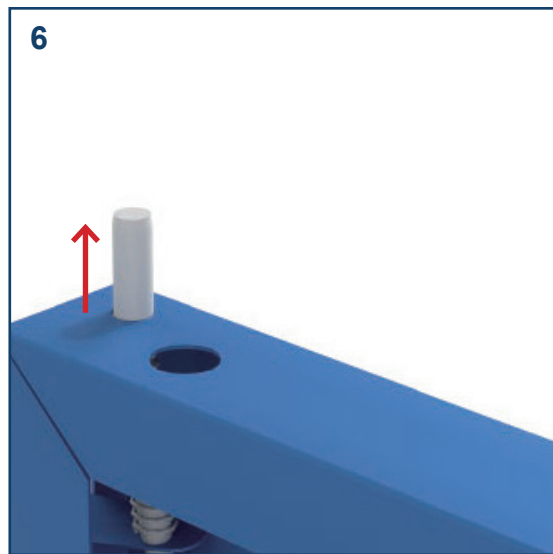
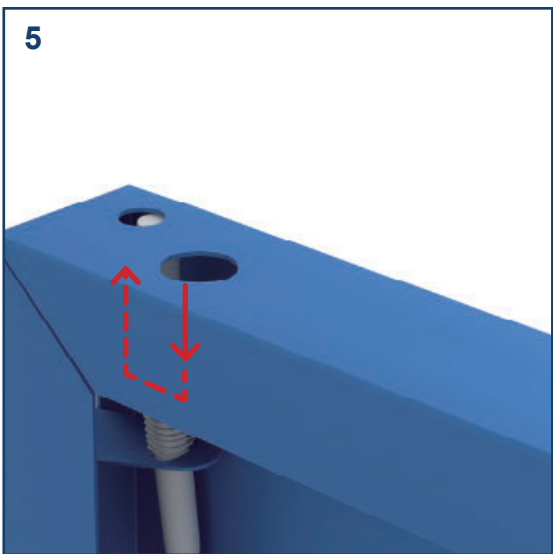
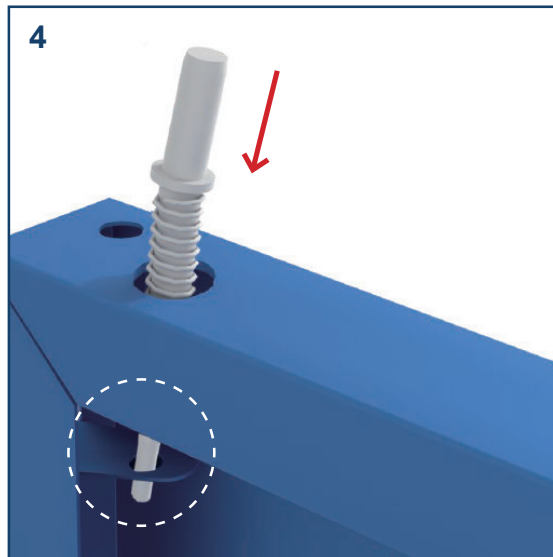
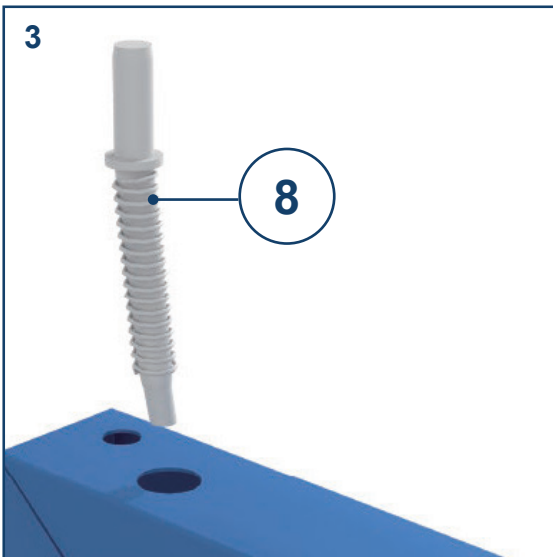
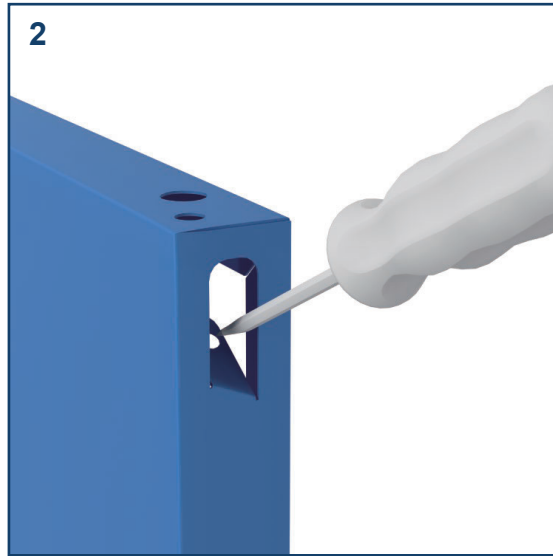
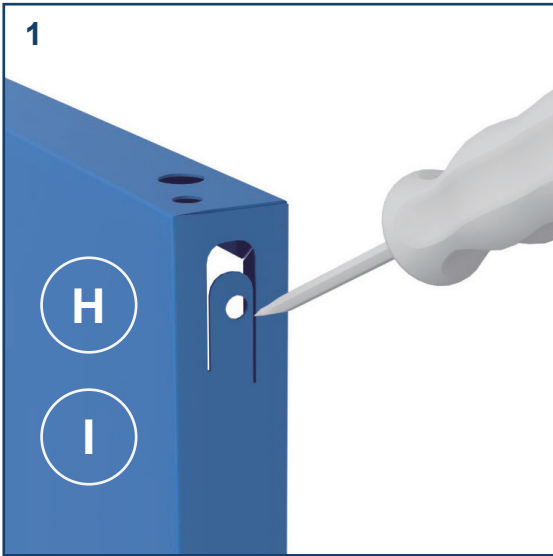

16

2x

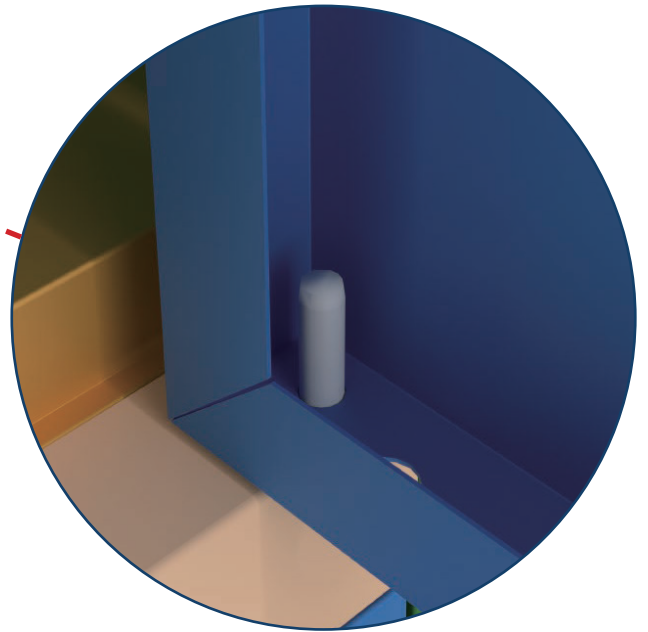
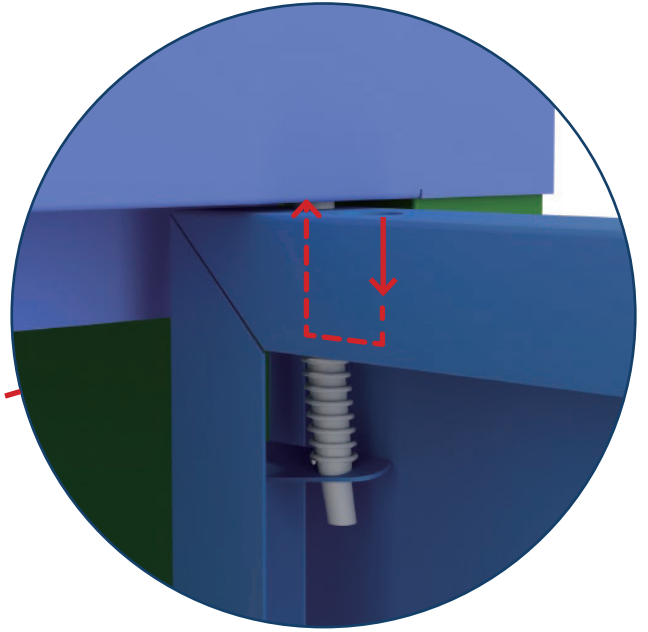
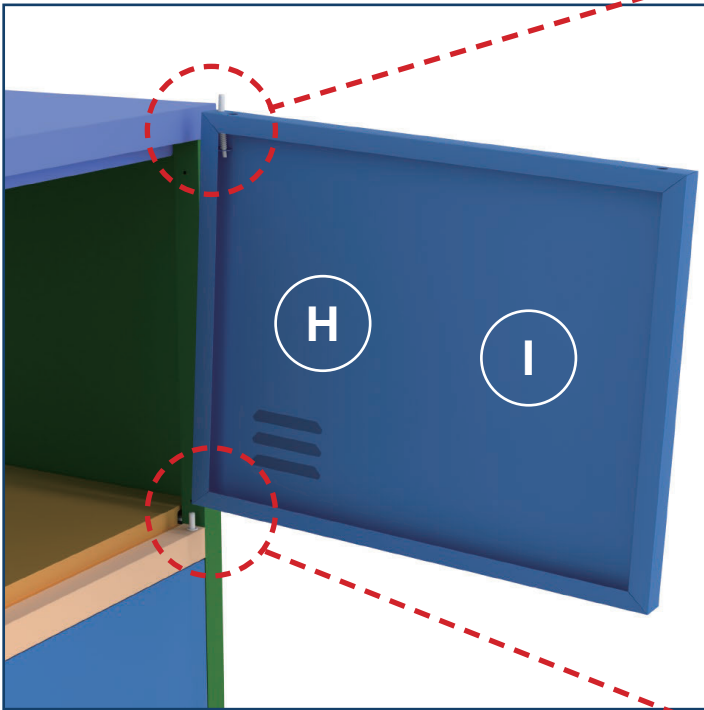

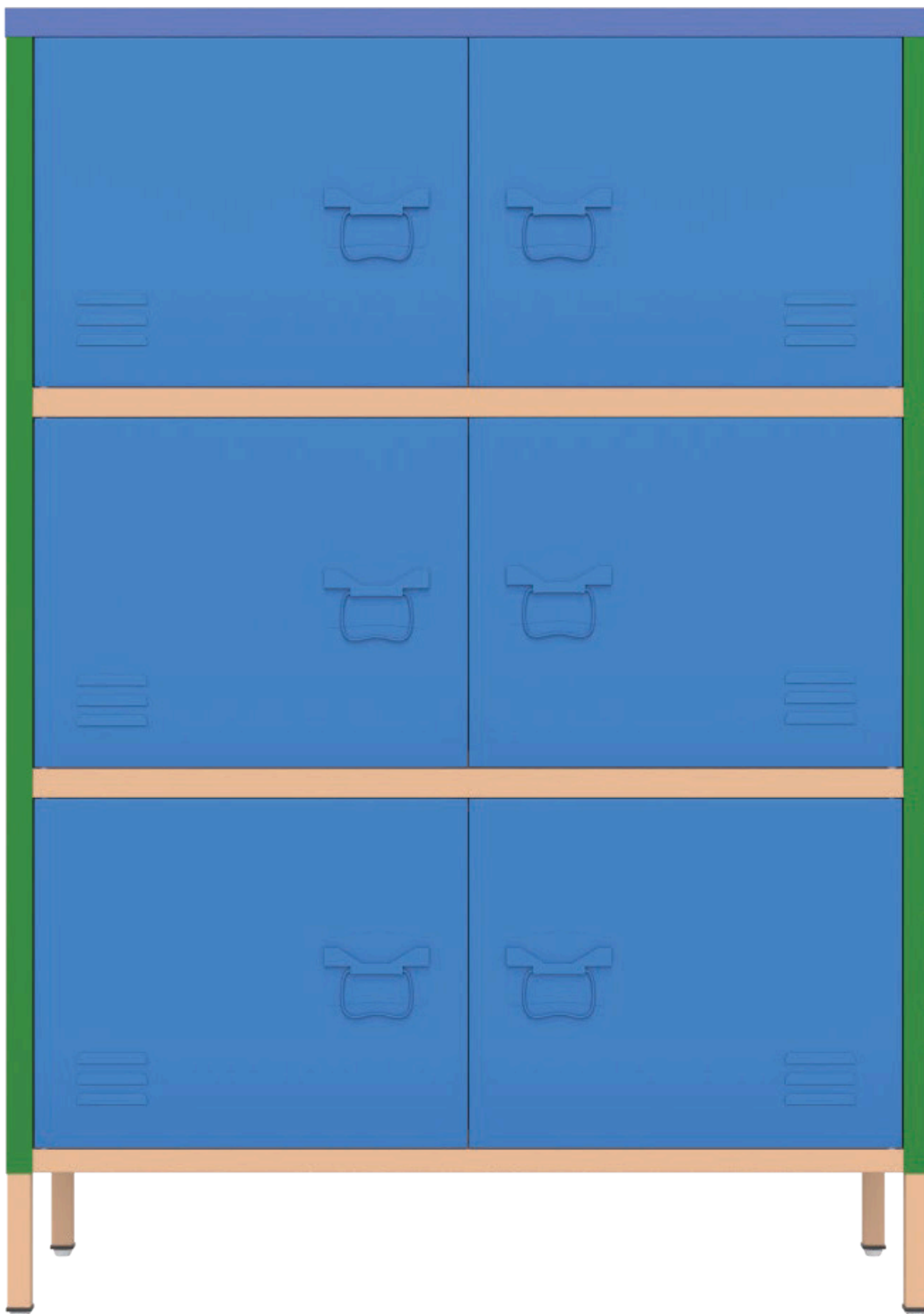

Hinweise zur Nutzung - Usage Notes

Warnhinweis:

Achtung! Benutzung unter unmittelbarer Aufsicht von Erwachsenen. Halten Sie alle kleinen Teile und Verpackungsmaterialien fern von Kindern, ansonsten besteht Erstickungsgefahr.

Sicherheitshinweis:

Bitte überzeugen Sie sich regelmäßig vom festen Sitz aller Elemente.

Achtung:

Heben Sie die Aufbauanleitung für eine spätere Demontage bzw. Montage gut auf.

Was Sie sonst noch wissen sollten:

Sollte es trotz ständiger Produktionsüberwachung zu einem Mangel kommen, so kreuzen Sie das entsprechende Bauteil auf dieser Aufbauanleitung bitte deutlich an. Senden Sie uns ein Bild der markierten Aufbauanleitung, einer kurzen Beschreibung des Fehlers bzw. des Problems und eine Kopie des Kaufbelegs per E-Mail an service@bela-living.de oder alternativ postalisch an die unten aufgeführte Adresse.

Warning:

Caution! Use under the direct supervision of adults. Keep all small parts and packaging materials away from children, otherwise they may pose a choking hazard.

Safety requirements:

Please check regularly that all the elements are well tightened.

Warning:

Keep the assembly plan for future disassembly or assembly.

What else you should know:

If, despite constant supervision of the production process, a flaw should turn up, please mark the respective part clearly in this assembly plan. Send us a picture of the marked assembly plan, a short description of the problem and a copy of the receipt by e-mail to service@bela-living.de or by post to the address listed below.

OHNE RÜCKSENDUNG DES KAUFBELEGS ERFOLGT KEINE ANERKENNUNG EINER EVENTUELLEN REKLAMATION.

WITHOUT RECONSIGNMENT OF THE RECEIPT POSSIBLE COMPLAINTS WILL NOT BE TAKEN INTO CONSIDERATION.

Bela Living GmbH Wallstraße 9-13 10179 Berlin Deutschland service@bela-living.de