

90 min

DEROMI

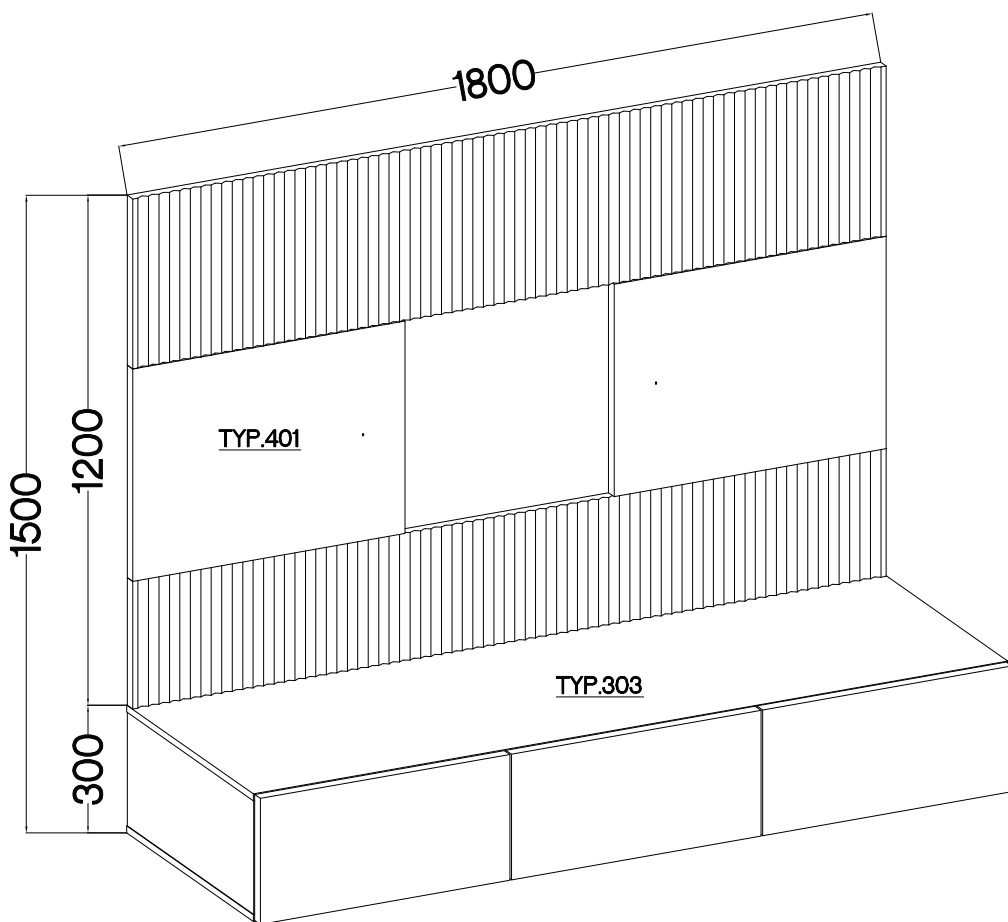
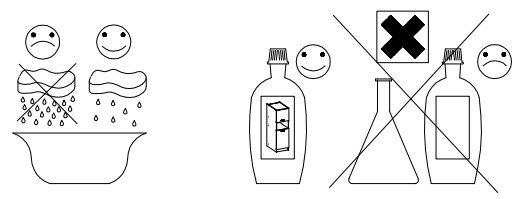

TYP.401

†8x20mm	†14		†6,3x9mm	†10x50mm	6,5/53mm	†4.0x30mm	†5.0x60mm
A4	E13	K7	M4	O7	O14	P8	P12
8	2	4	8	6	4	34	2

TYP.303

†8x30mm	†15/12mm	L=20mm		†35/0mm	L	R	L=270mm 80 N		BARKOWY
A	C	D2	E	HG	K25	K26		K33	
16	16	16	16	6	2	2		3	
				6,5/68mm	†10x50mm	†3.5x13mm	†3.0x20mm	†4.0x30mm	
L	L2	L33		O4	O7	P5	P7	P8	
14	4	3		4	4	18	4	8	

ISM-DMI-001

TYP.401

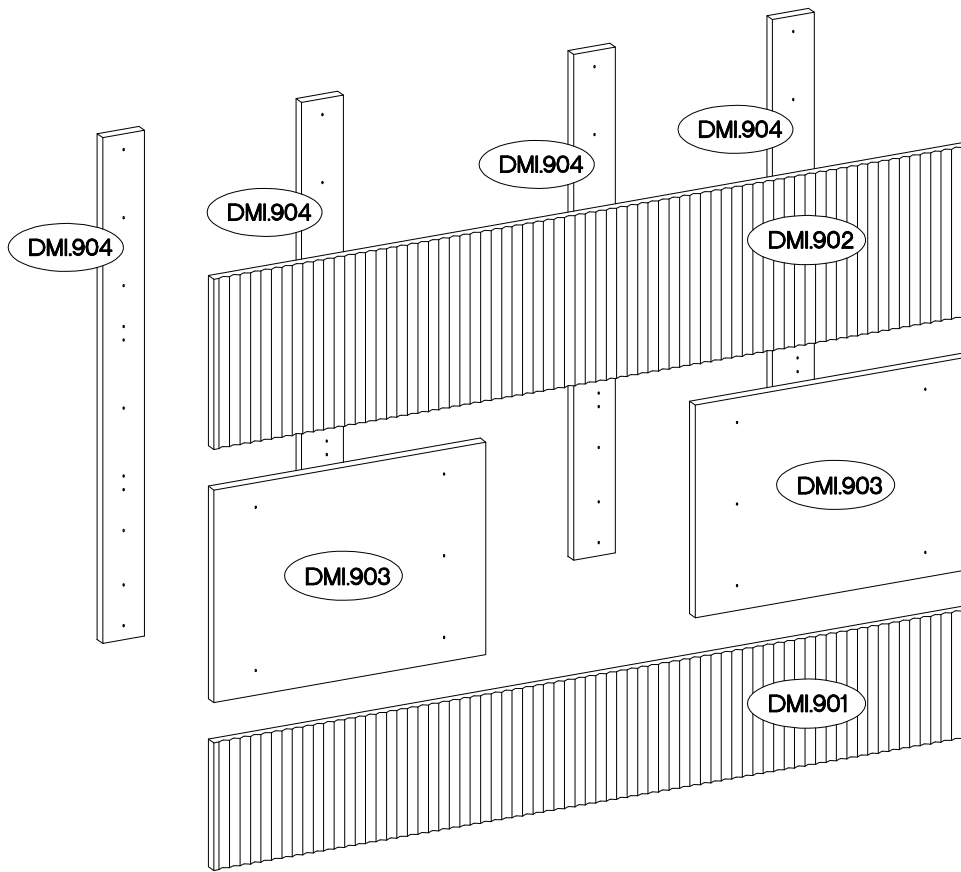



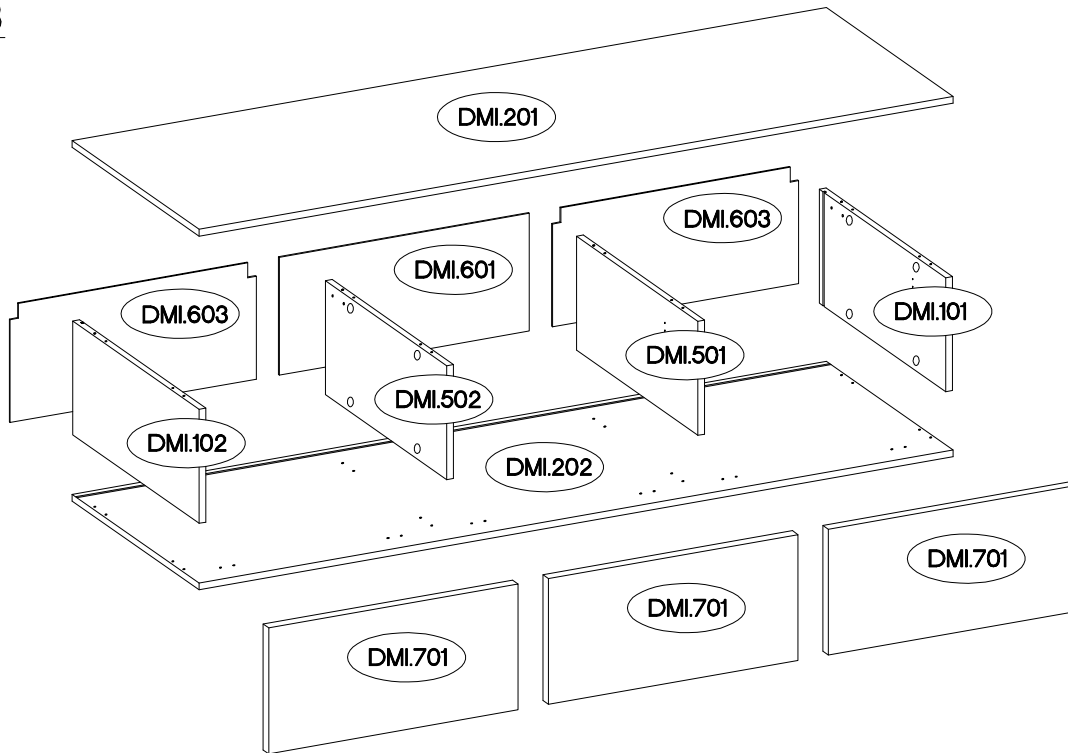

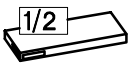
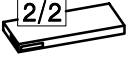
TYP.303



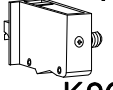

	Ersatzteil Nummer	Dimension		Ersatzteil Nummer	Dimension
	DMI.501	268x349x16		DMI.101	268x363x16
	DMI.502	268x349x16		DMI.102	268x363x16
	DMI.601	597x277x2,5		DMI.201	1802x364x16
	DMI.603 x2	588x277x2,5		DMI.202	1802x364x16
	DMI.701 x3	296x596x16		DMI.901	300x1800x16
	DMI.903 x2	500x650x16		DMI.902	400x1800x16
				DMI.904 x4	1190x100x16

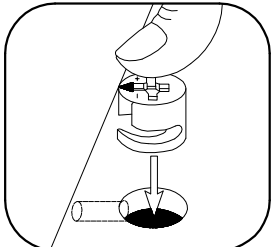
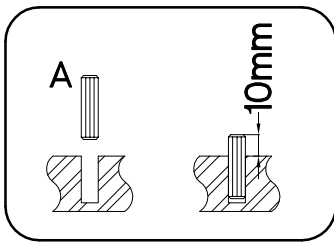
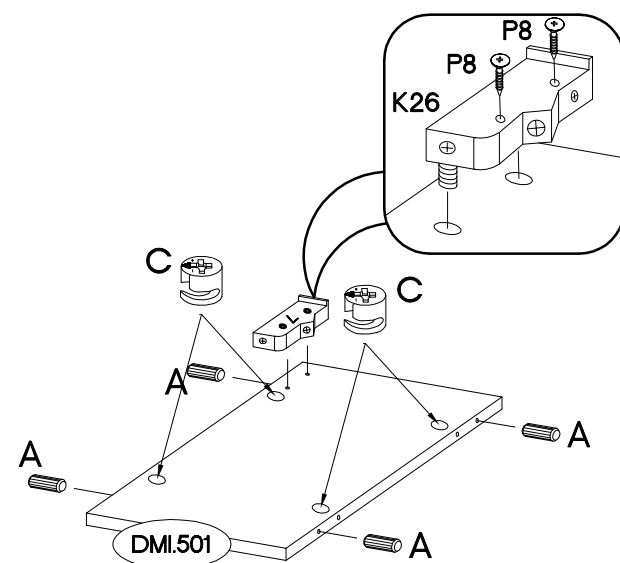
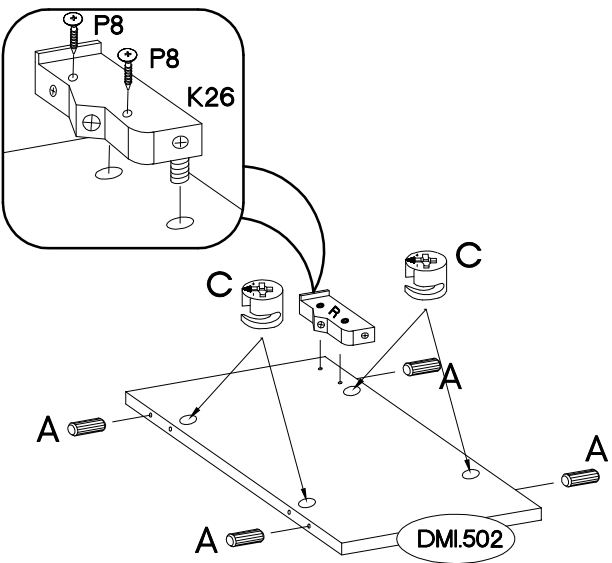
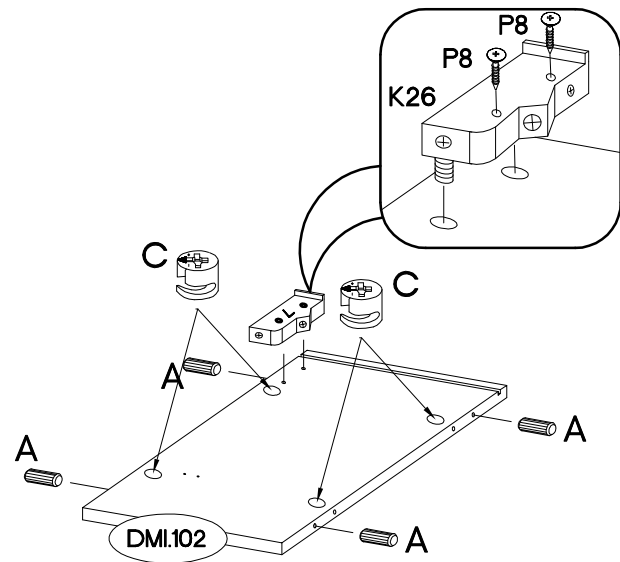
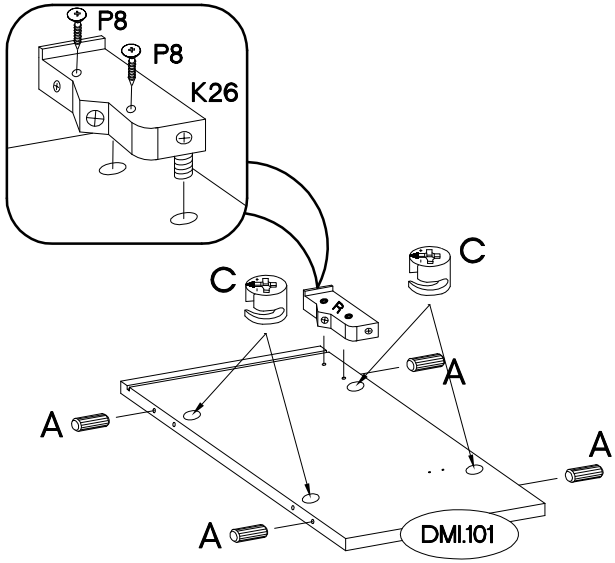
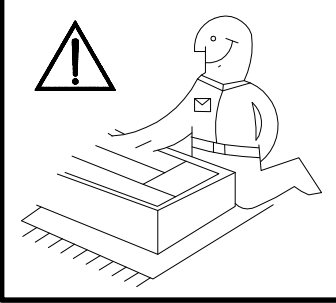

$\pm 8 \times 30 \text{mm}$  A 16	$\pm 15/12 \text{mm}$  C 16	L  K25 2	R  K26 2	$\pm 4.0 \times 30 \text{mm}$  P8 8
--	--	---	---	--

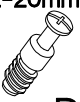
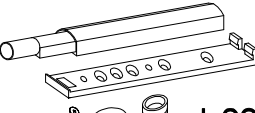

2

L=20mm  D2 16	 L33 3	±3.5x13mm  P5 6
--	--	--

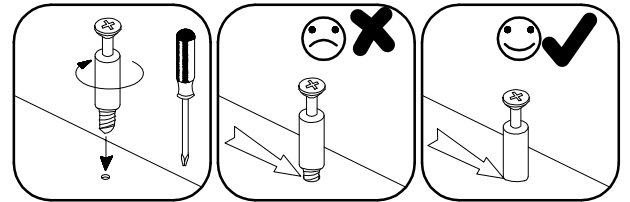
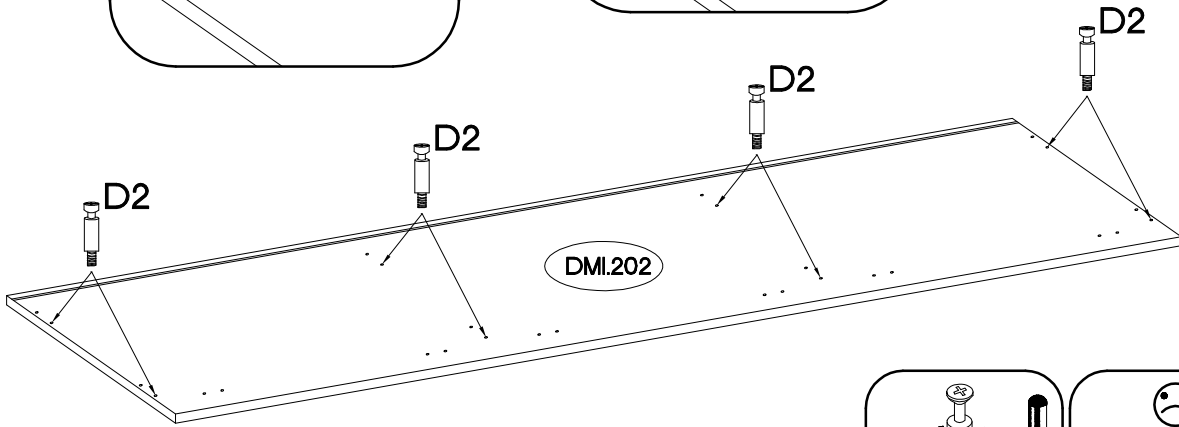
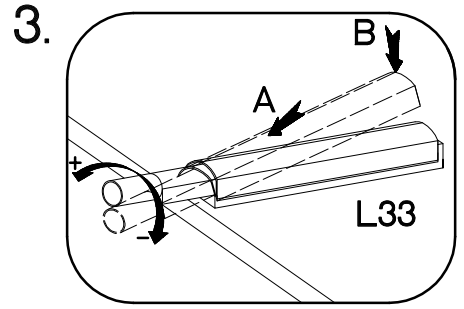
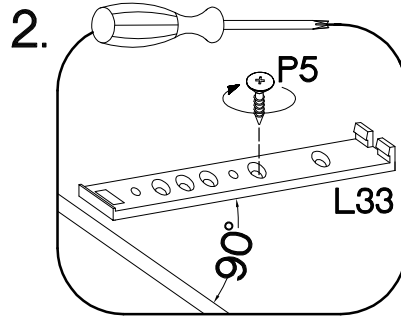
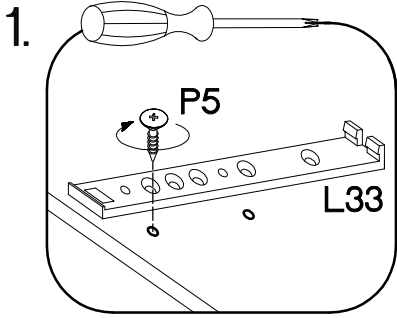
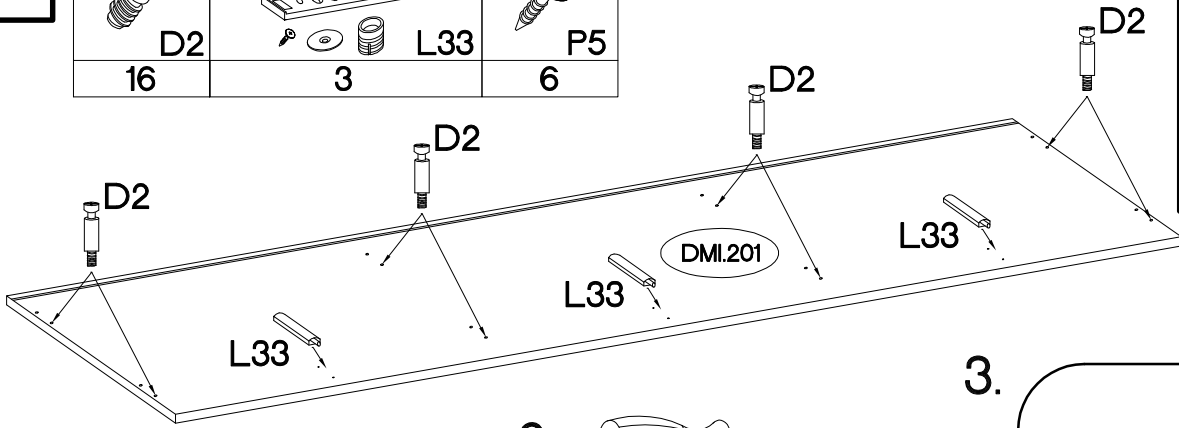
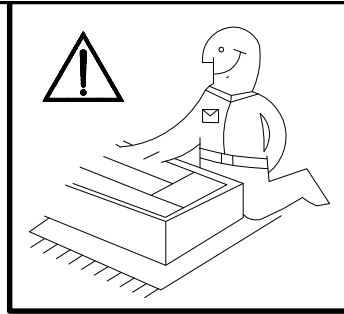

3

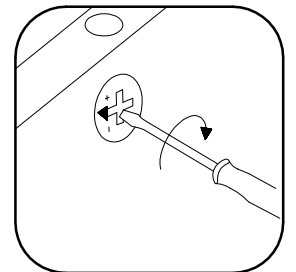
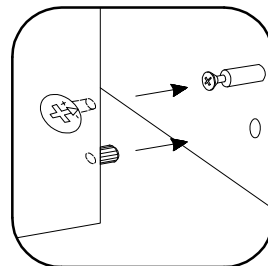
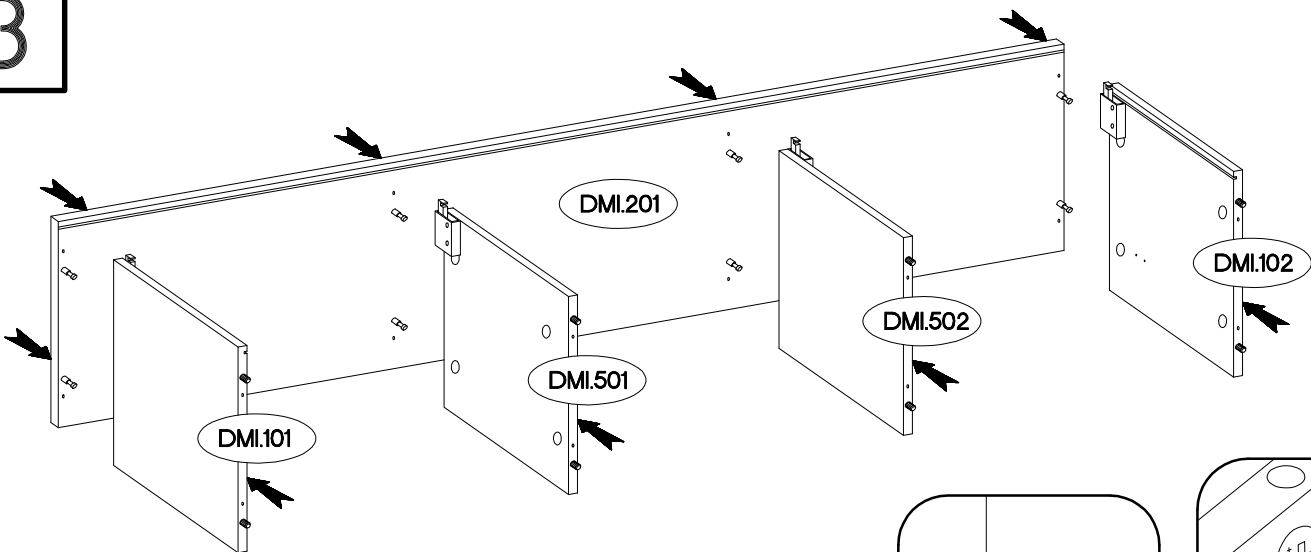

4

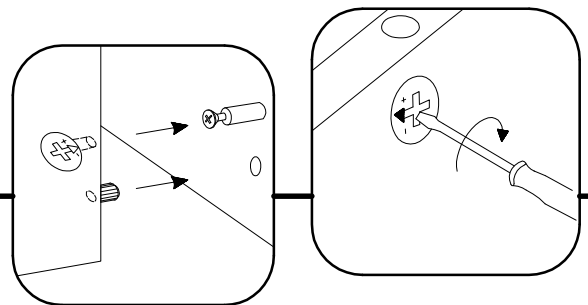
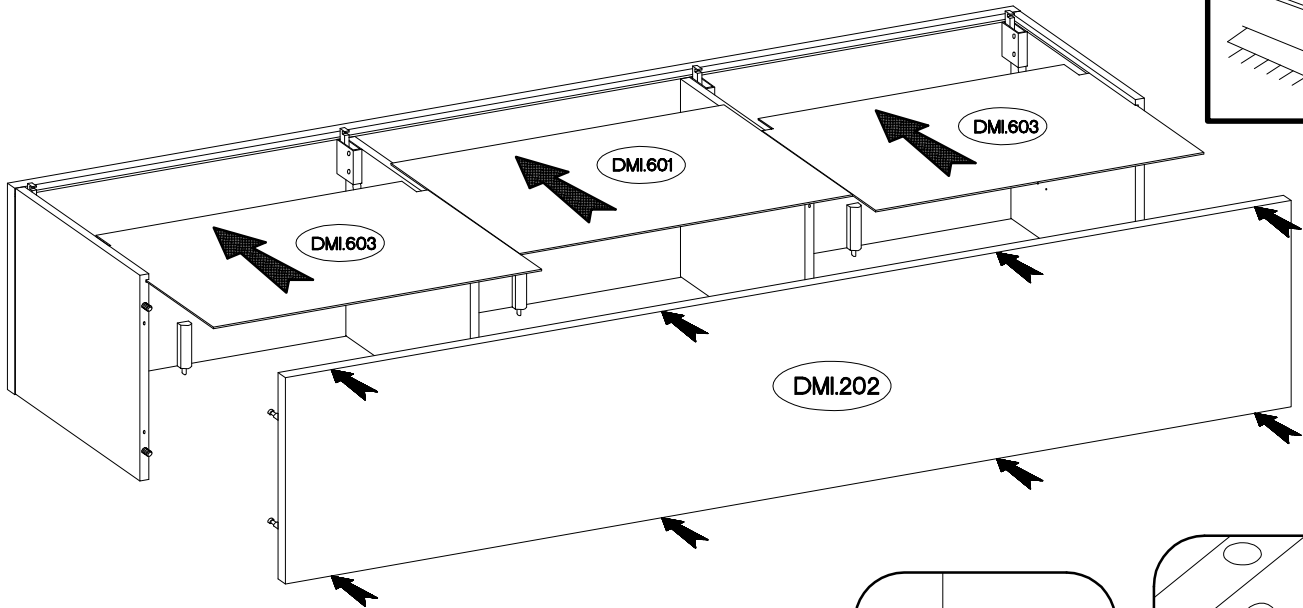
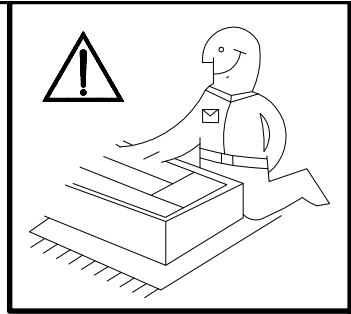

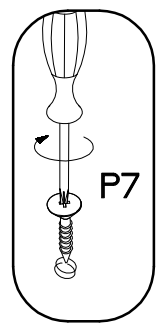
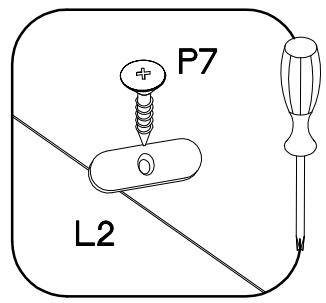
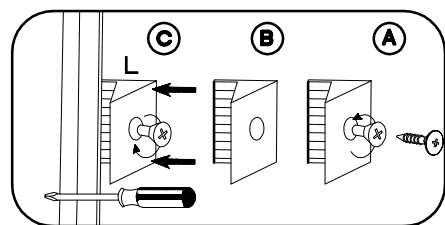
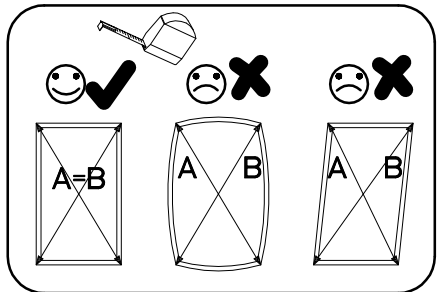
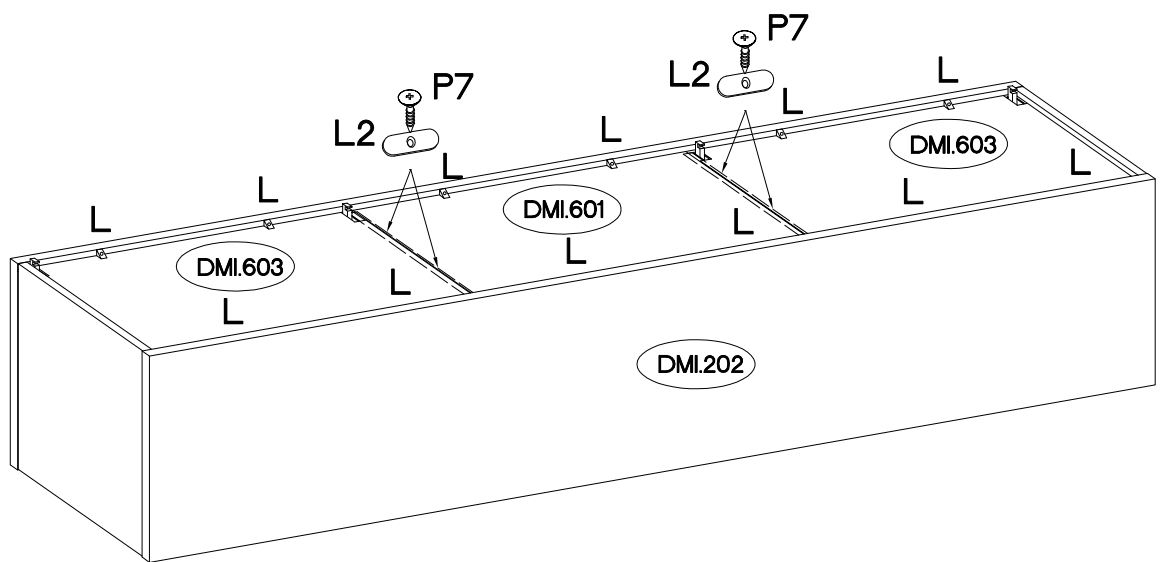

5

 †3.0x20mm P7 4	 L2 4	 L 14
--------------------------	-------------	-------------



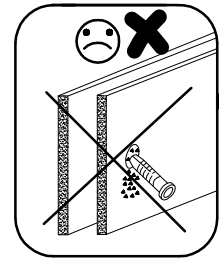
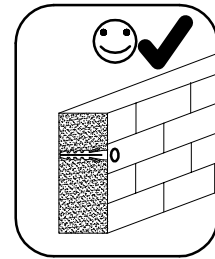
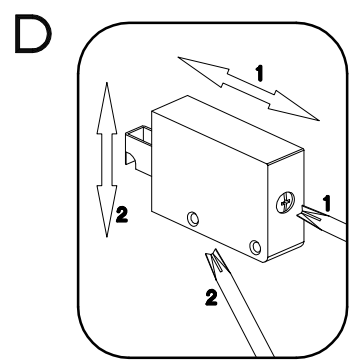
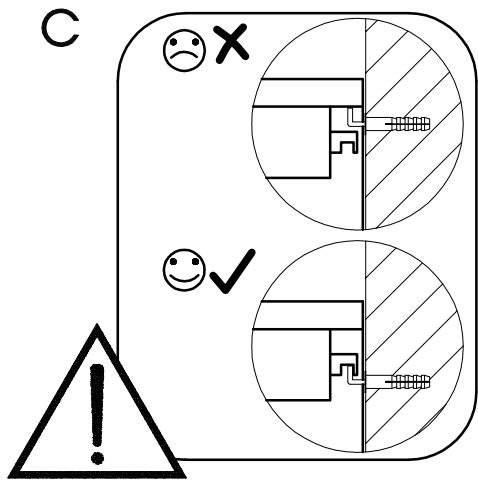
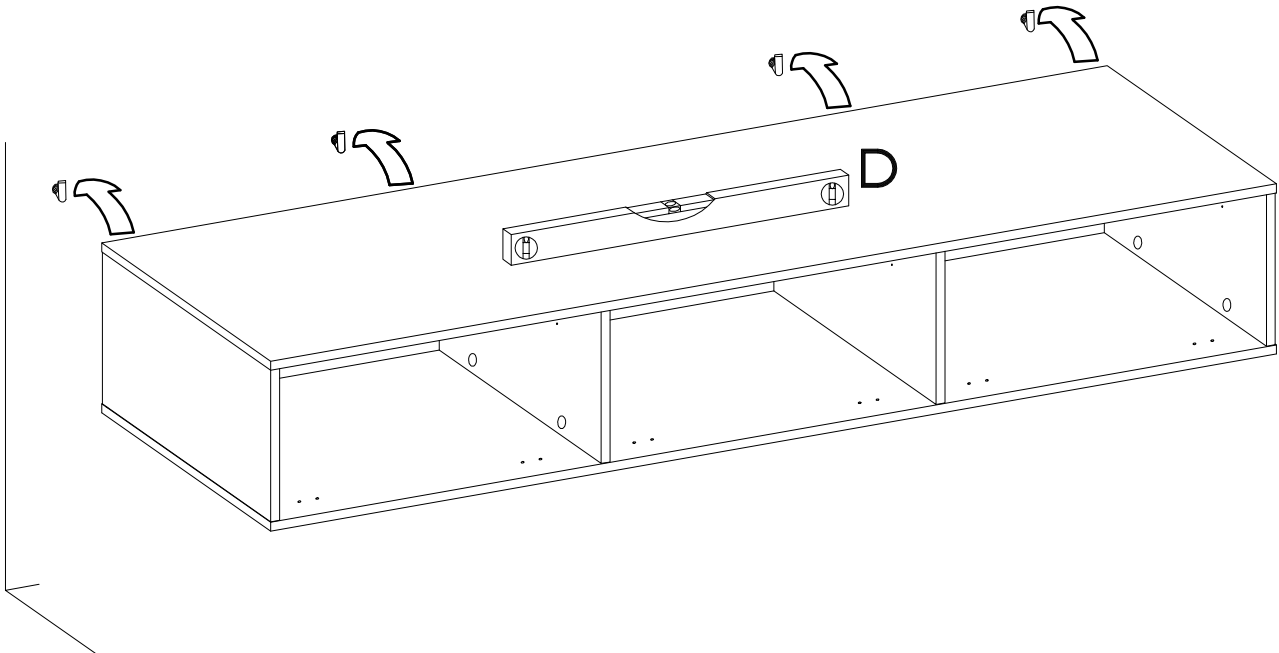
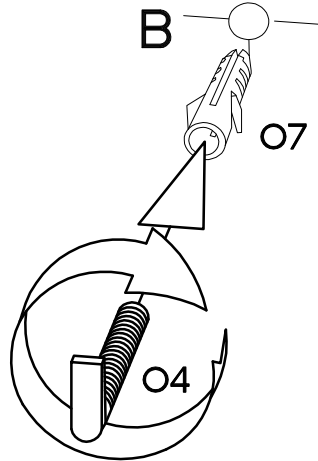
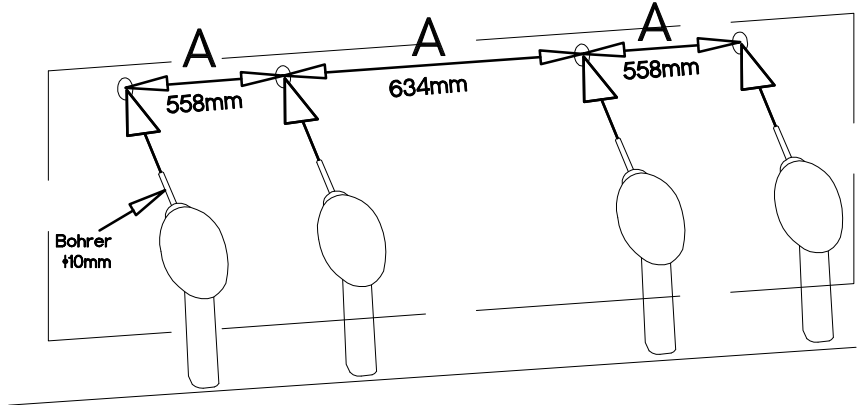

6

 O7 4	 O4 4
---	---

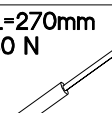
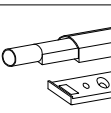

7

 HG 6	 P5 12	 L=270mm 80 N K33 3	 L33 3
---	--	---	--

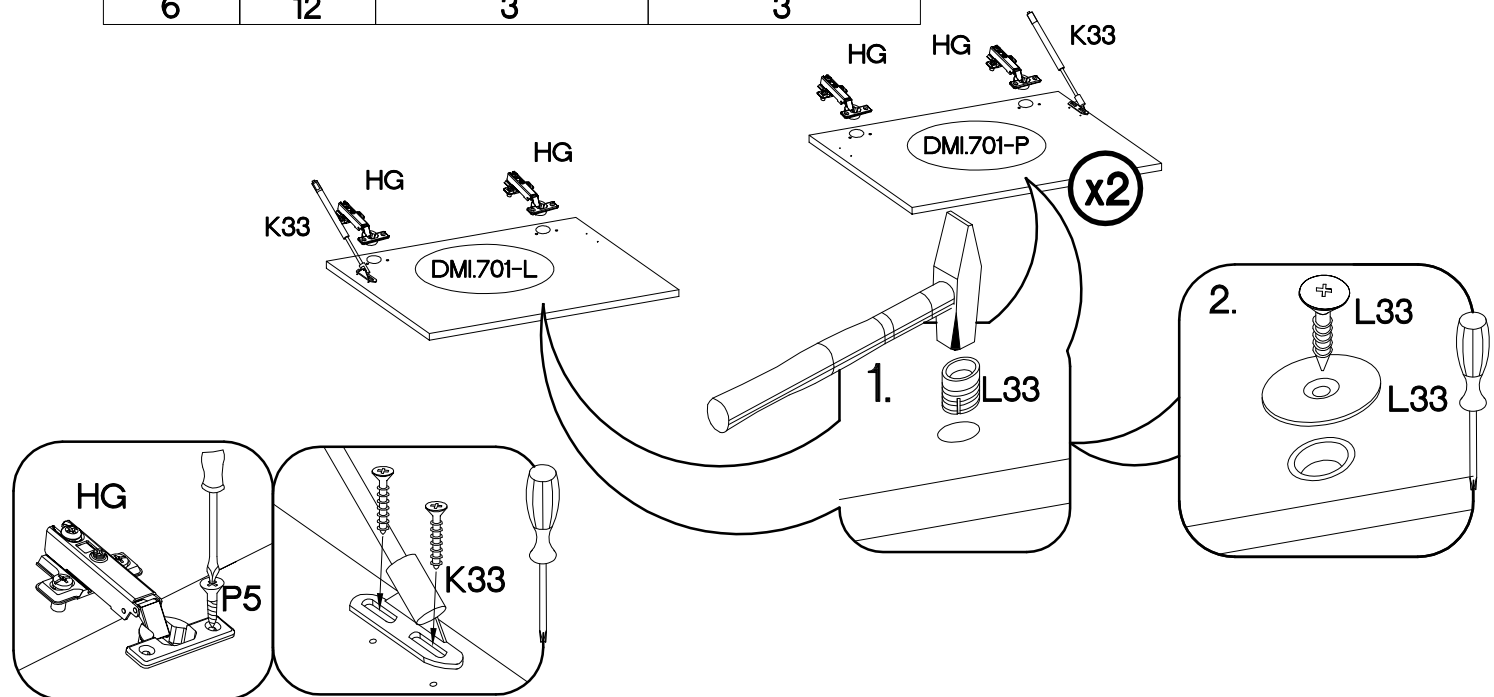

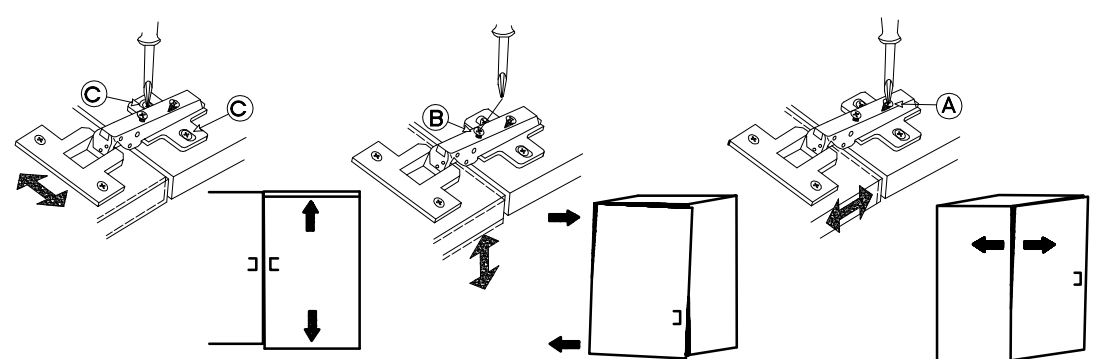
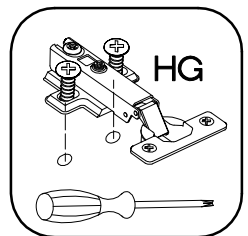
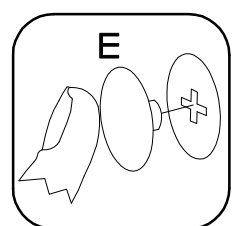
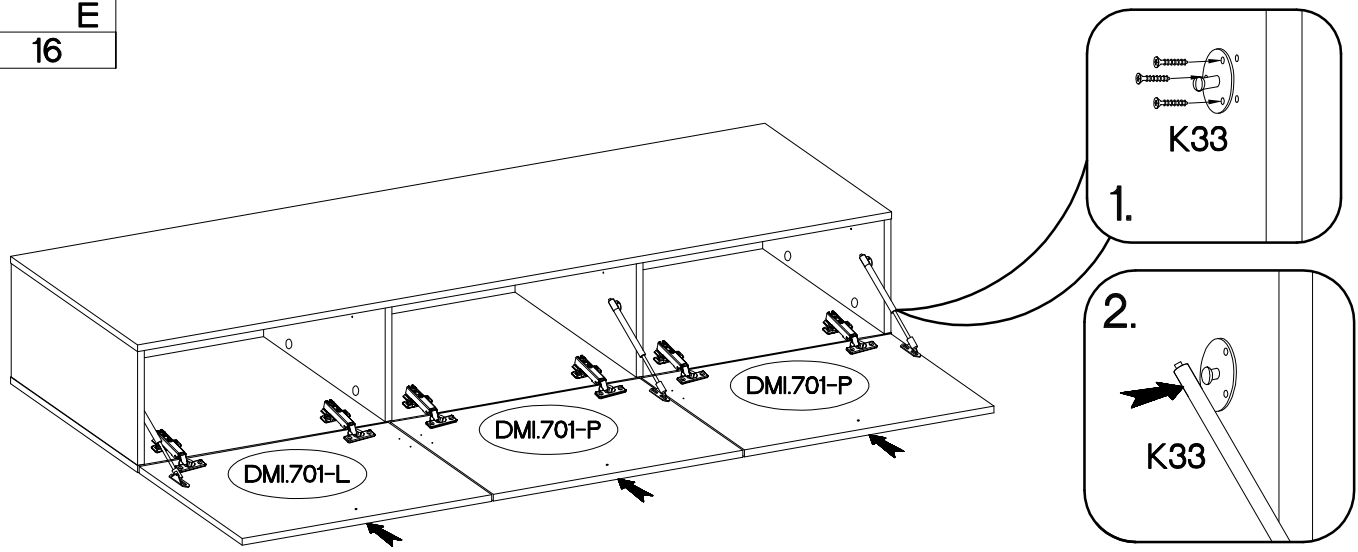

8

 E 16



9

	$\pm 6,3 \times 9 \text{mm}$ 	$\pm 8 \times 20 \text{mm}$ 
K7	M4	A4
4	8	8

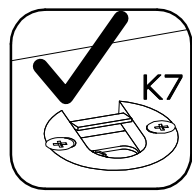
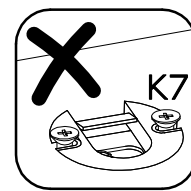
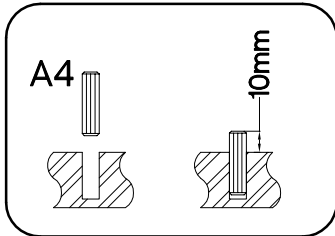
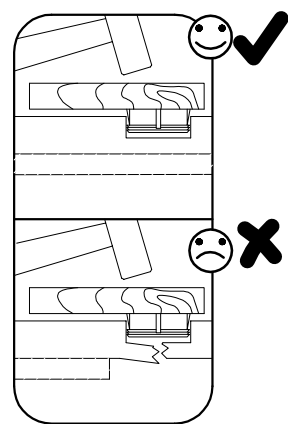
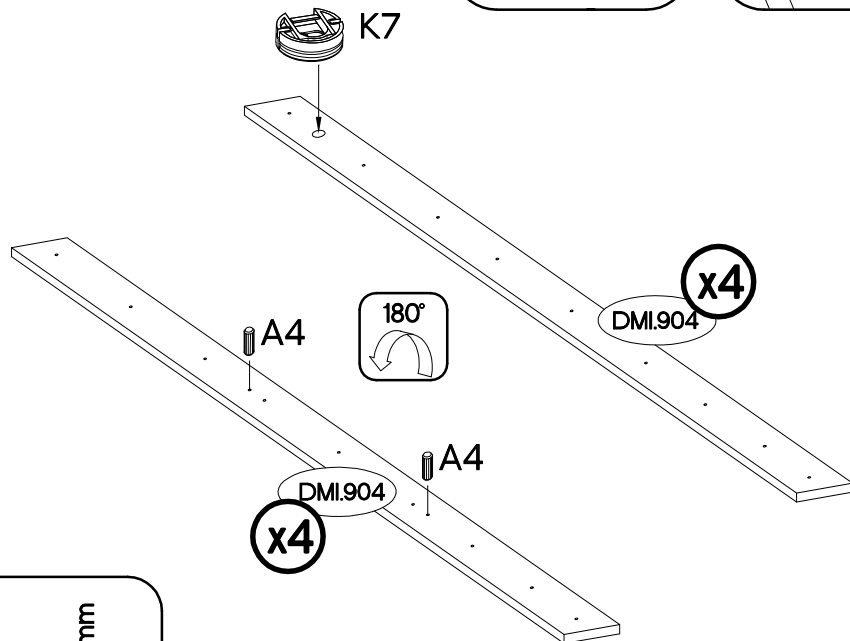
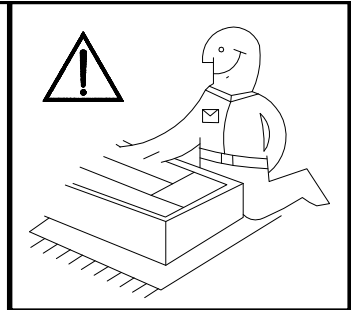
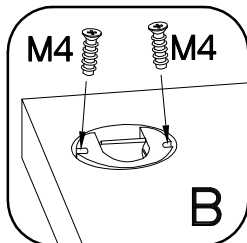
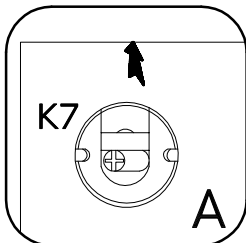

10

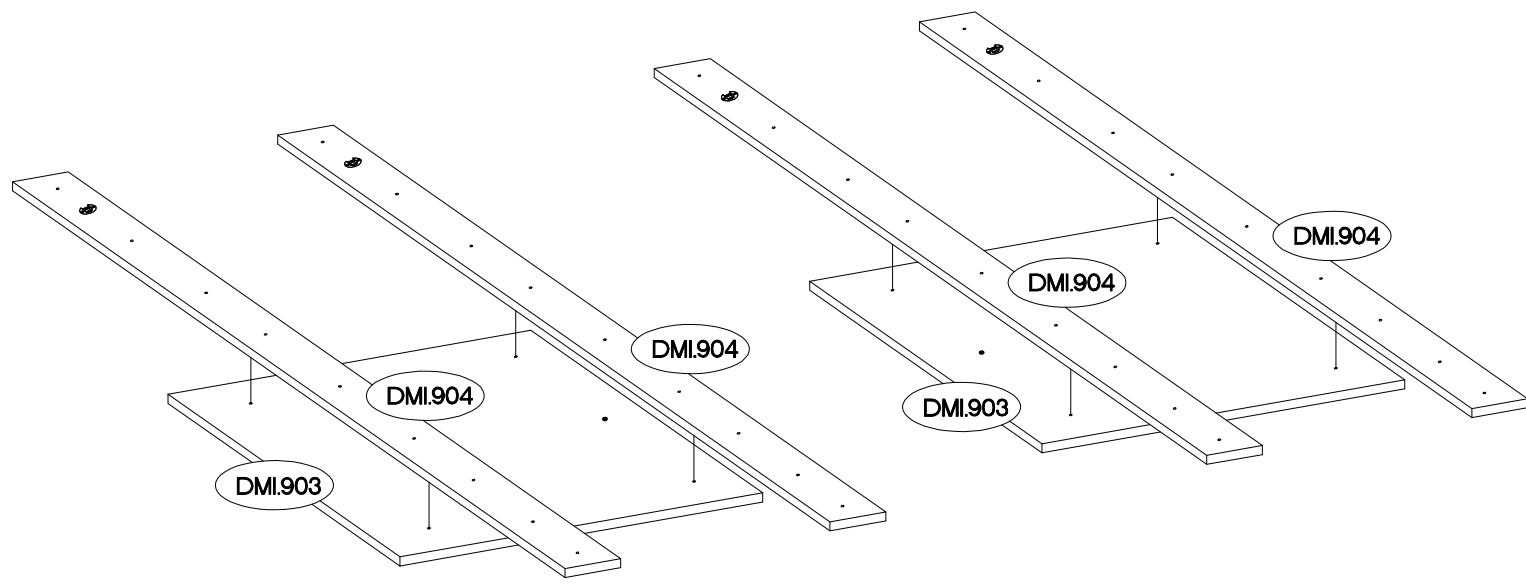
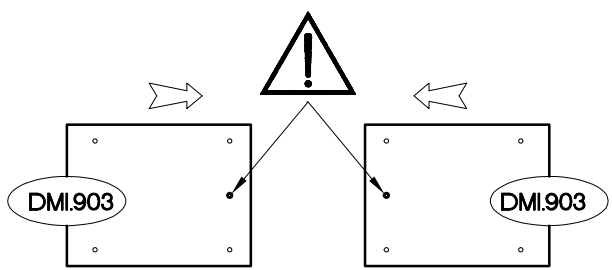

11

4.0x30mm



P8

10

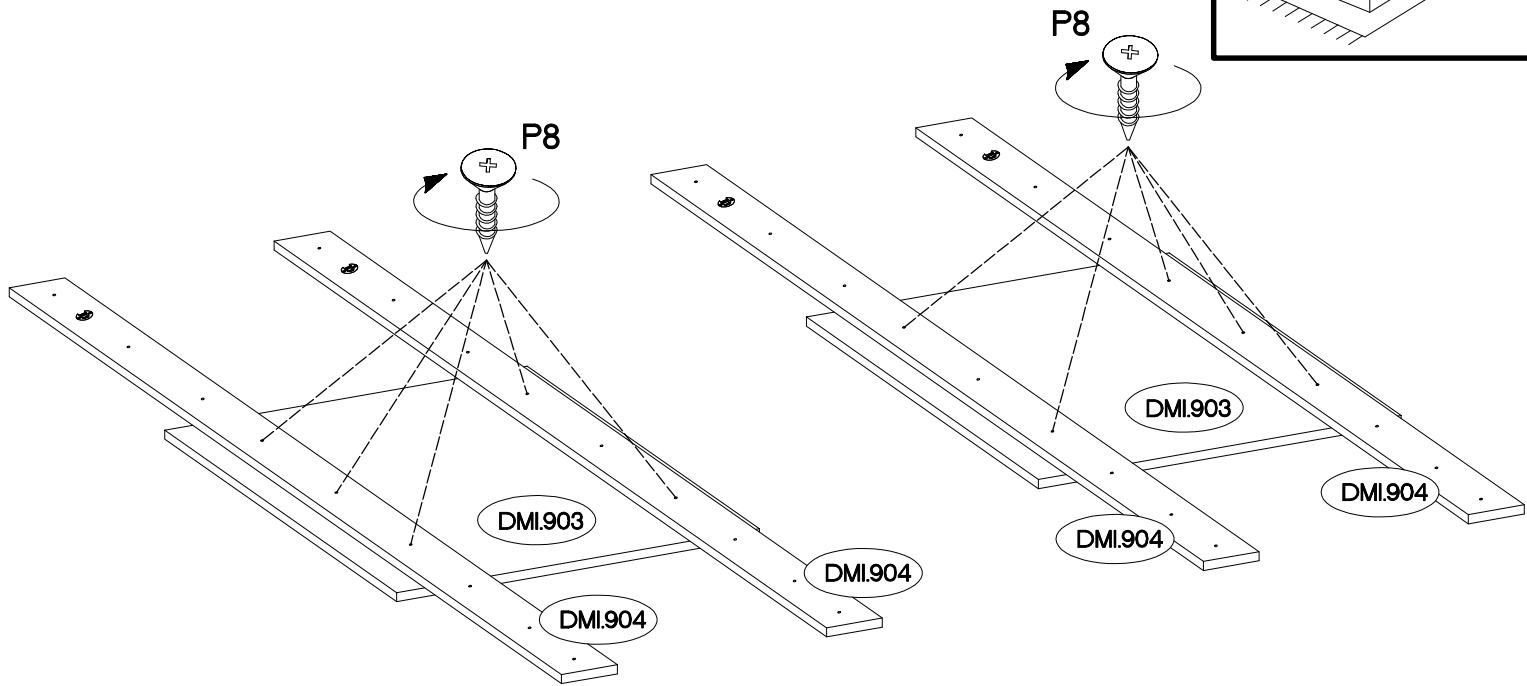
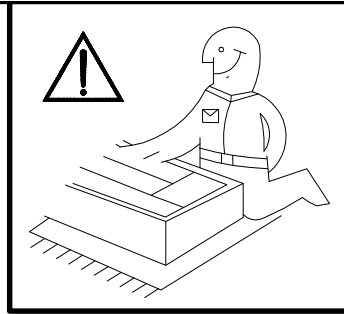

12



4.0x30mm

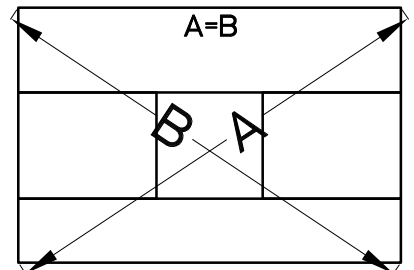
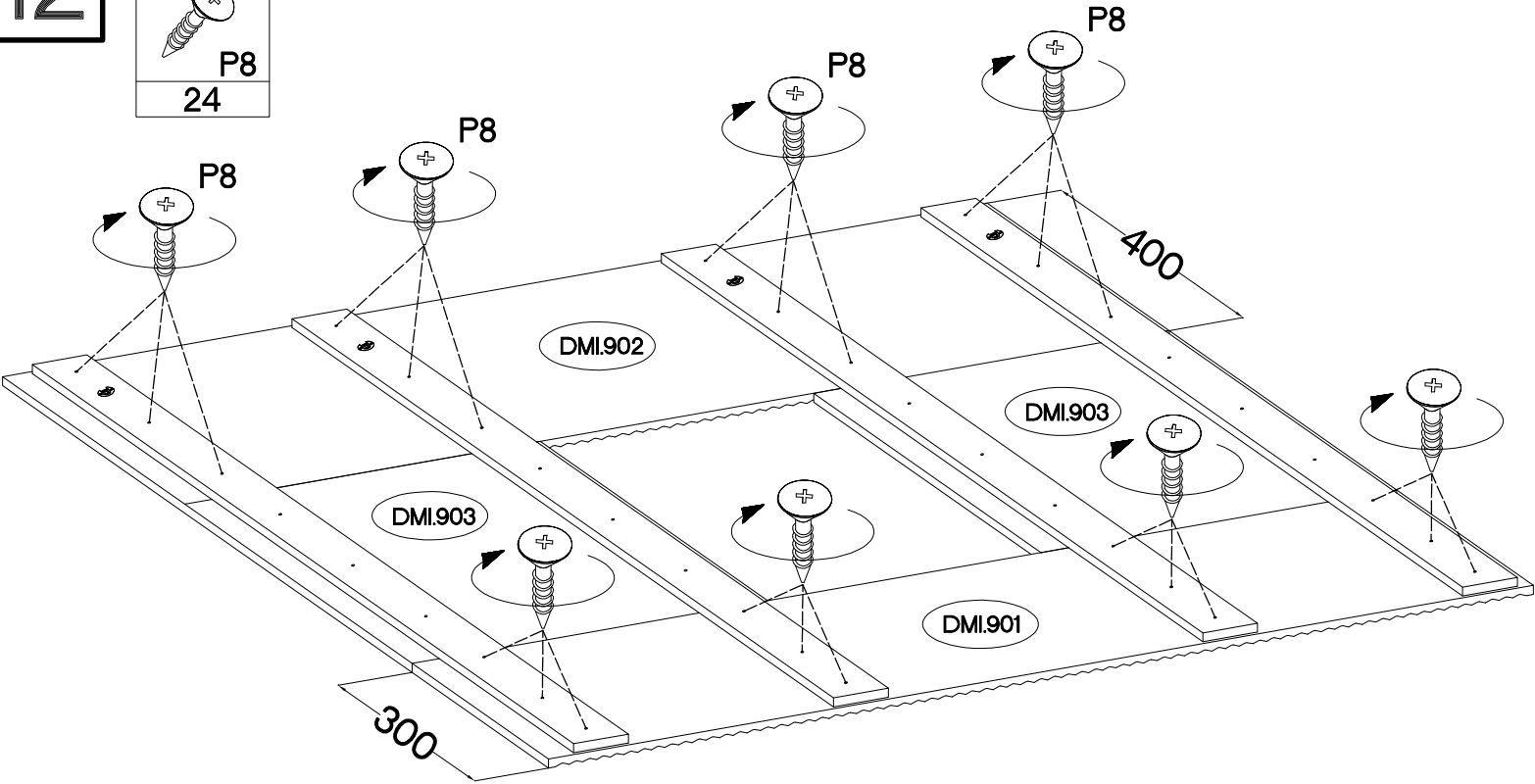

P8

24



 $\varnothing 10 \times 50 \text{mm}$	 6,5/53mm
O7	O14
4	4

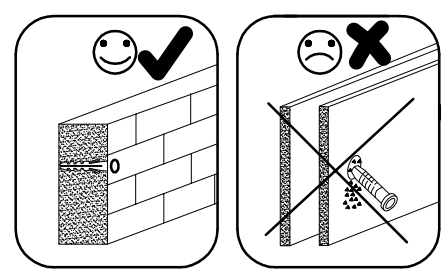
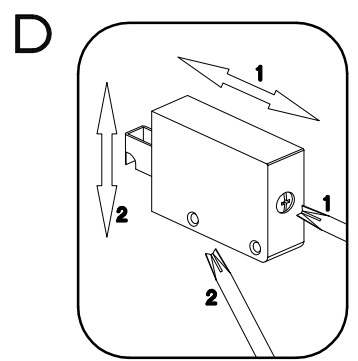
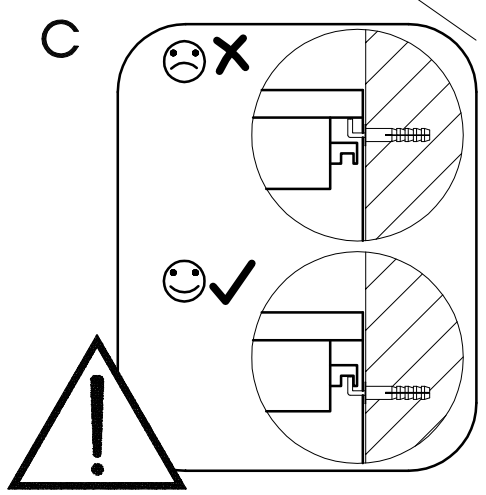
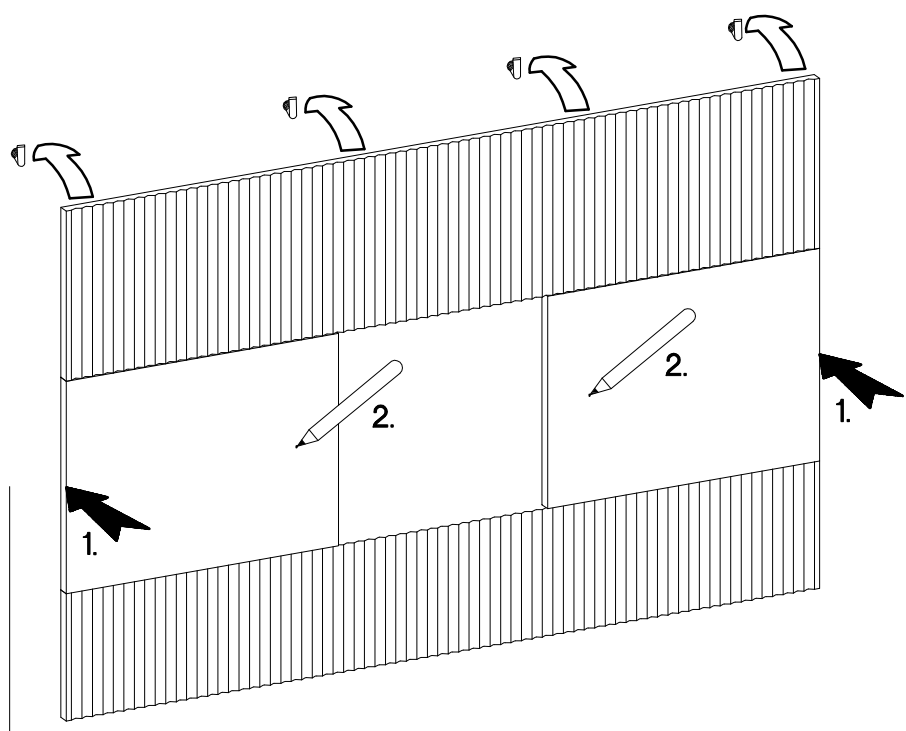
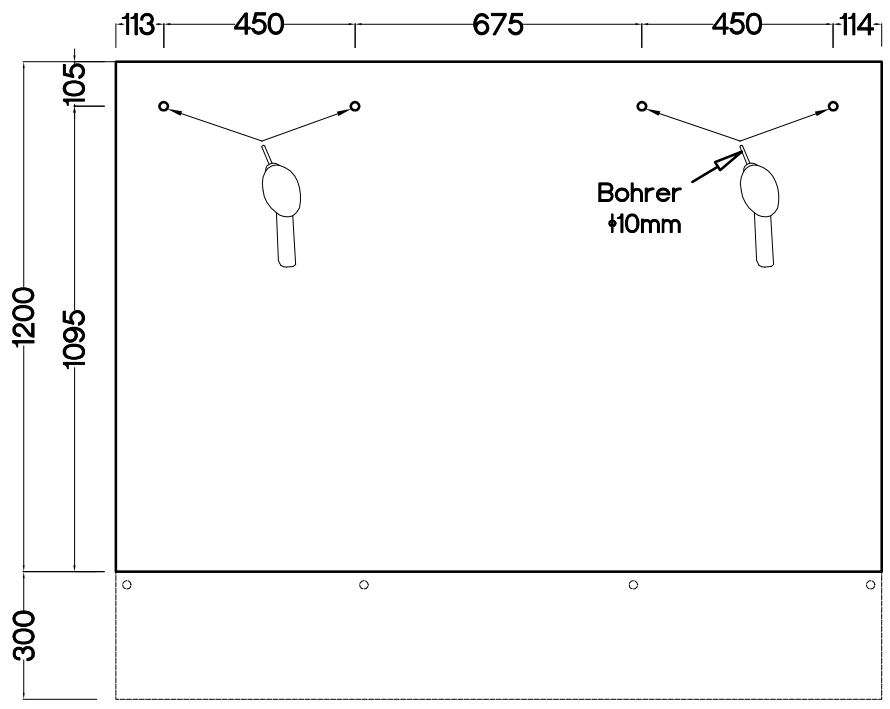



†10x50mm

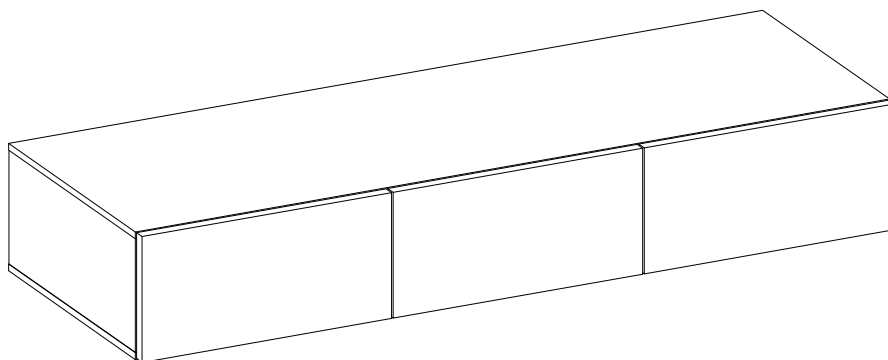
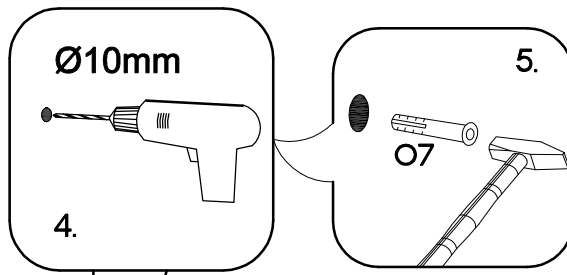
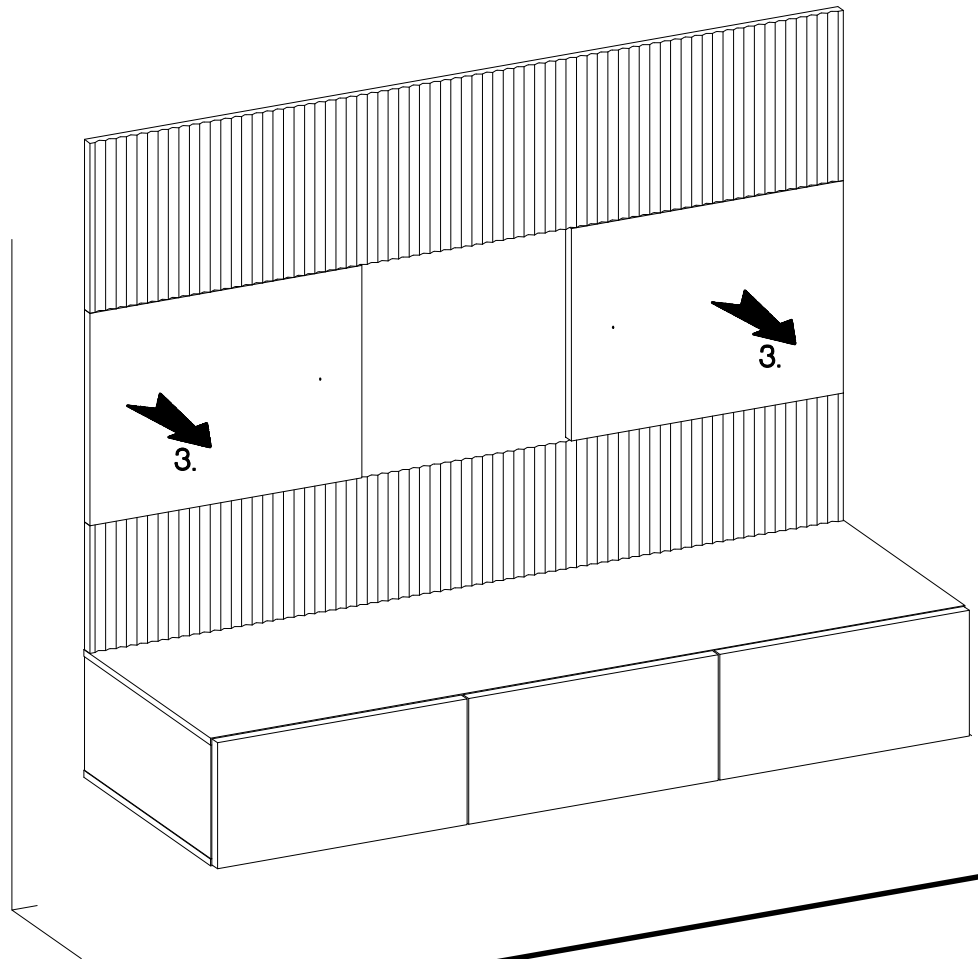

O7

2



5.0x60mm  P12 2	14  E13 2
---	--

