

Installation sanleitung  
Installation Instruction  
Instruction d'installation

# Doppelbett-140x190

N616P465403/N616P465404

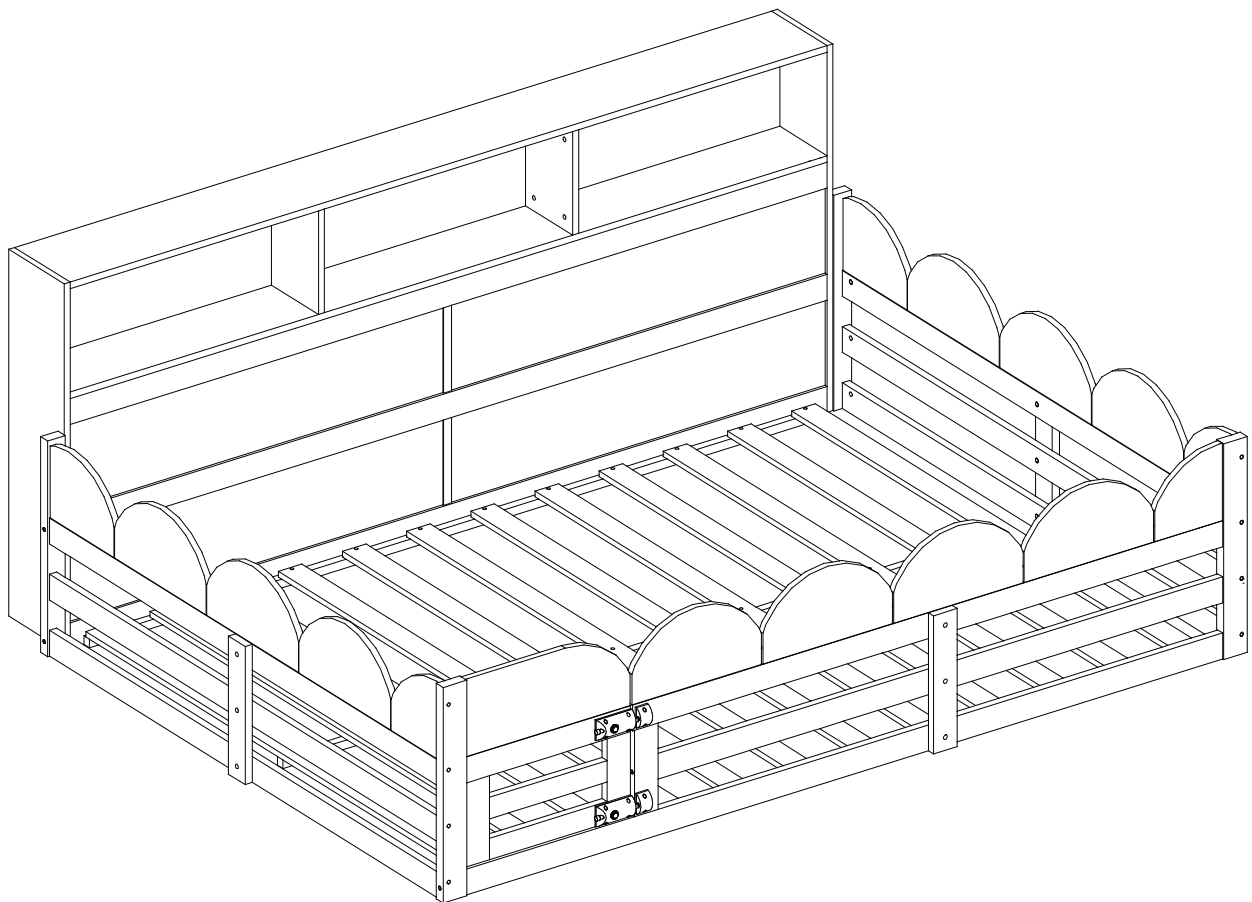

Unser Produkt wird Ihnen in 2 Paketen geliefert. Die Lieferzeiten dieser 2 Pakete können abweichen, bitte haben Sie etwas Geduld und vielen Dank für Ihr Verständnis.

Our product will be delivered to you in 2 packages. The delivery times of these 2 packages may differ, please be patient and thank you for your understanding.

Notre produit vous sera livré en 2 colis. Les délais de livraison de ces 2 colis peuvent différer, soyez patient et merci pour votre compréhension.

# INSTRUCTIONS

## IMPORTANT-READ CAREFULLY-RETAIN FOR FUTURE REFERENCE

- a) **WARNING** -Children can become trapped between the bed and the wall, the adjoining pieces of furniture (e.g. cupboards) and the like. To avoid risk of serious injury the distance between the safety barrier and the adjoining structure shall not exceed 75 mm or shall be more than 230 mm.
- b) **WARNING**-Do not use the bed if any structural part is broken or missing; Replacement parts are between requested from the manufacturer or the store.
- c) **WARNING**-Do not climb or wiggle on any non-designated structures.
- d) it is imperative to always follow the installation instructions and manufacturer's use.
- e) **The recommended size of the mattress to be used with the bed is 140cmx190cm, maximum thickness mattress:12cm.**
- f) It is necessary to ventilate the room in order to maintain a low level moisture and prevent mold growth in the bed and its periphery.
- g) Joining devices should always be tightened properly and regularly verified. Tighten if necessary.

# ANLEITUNGEN

## WICHTIG - SORGFÄLTIG LESEN - FÜR SPÄTERE VERWENDUNG

### AUFBEWAHREN

- a) **WARNUNG** - Kinder können zwischen dem Bett und der Wand, den angrenzenden Möbelstücken (z. B. Schränken) und der Lücke eingeklemmt werden. Um die Gefahr schwerer Verletzungen zu vermeiden, darf der Abstand zwischen der Sicherheitsbarriere und der angrenzenden Struktur nicht mehr als 75 mm oder mehr als 230 mm betragen.
- b) **WARNUNG**-Das Bett darf nicht benutzt werden, wenn ein Bauteil gebrochen ist oder fehlt; Ersatzteile sind beim Hersteller oder im Geschäft anzufordern.
- c) **WARNUNG** - Klettern oder wackeln Sie nicht auf nicht dafür vorgesehenen Strukturen.
- d) Befolgen Sie unbedingt die Installationsanweisungen und die Gebrauchsanweisungen des Herstellers.
- e) **Die empfohlene Größe der Matratze für das Bett beträgt 140x190cm, maximale Dicke der Matratze: 12cm.**
- f) Es ist notwendig, den Raum zu lüften, um die Feuchtigkeit niedrig zu halten und Schimmelbildung im Bett und seiner Umgebung zu verhindern.
- g) Die Verbindungselemente sollten immer richtig angezogen sein und regelmäßig überprüft werden. Ziehen Sie sie gegebenenfalls nach.

## English

### IMPORTANT ! KEEP FOR FUTURE REFERENCE : READ CAREFULLY

- To be assembled by an adult. Assembly must be checked by an adult before use
- WARNING ! Keep all screws, small parts and plastic bags out of the reach of children
- Properly identify all parts before assembling
- Never use your item if any of its parts are broken or missing
- Should any problems arise, please contact our After Sales Service
- Manufacturer's instructions shall be followed at all times
- Care: Clean with a soft, dry cloth. In case of larger stains, carefully rub with a slightly damp, non-abrasive sponge
- Avoid the risk of fire by not placing furniture near sources of ignition or hot items
- Do not jump on the bed

## Deutsch

### WICHTIG ! ZUM SPÄTEREN NACHSCHLAGEN AUFBEWAHREN: SORGFÄLTIG LESEN

- Muss von einem Erwachsenen zusammengebaut werden. Der Zusammenbau muss vor dem Gebrauch von einem Erwachsenen überprüft werden
- WARNUNG! Bewahren Sie alle Schrauben, Kleinteile und Plastikbeutel außerhalb der Reichweite von Kindern auf
- Kennzeichnen Sie vor dem Zusammenbau alle Teile richtig
- Benutzen Sie Ihren Artikel niemals, wenn Teile gebrochen sind oder fehlen
- Sollten Probleme auftreten, wenden Sie sich bitte an unseren Kundendienst
- Die Anweisungen des Herstellers sind stets zu befolgen
- Pflege: Mit einem weichen, trockenen Tuch reinigen. Bei größeren Flecken vorsichtig mit einem leicht feuchten, nicht scheuernden Schwamm abreiben. nicht scheuernden Schwamm
- Vermeiden Sie die Gefahr eines Brandes, indem Sie die Möbel nicht in der Nähe von Zündquellen oder heißen Gegenständen aufstellen
- Nicht auf das Bett springen

## Français

### IMPORTANT ! CONSERVER POUR RÉFÉRENCE ULTÉRIEURE : LIRE ATTENTIVEMENT

- Le montage doit être effectué par un adulte. Le montage doit être vérifié par un adulte avant Utilisation
- ATTENTION ! Tenir les vis, les petites pièces et les sachets en plastique hors de portée des enfants
- Identifiez correctement toutes les pièces avant de les assembler
- N'utilisez jamais votre article si l'une de ses pièces est cassée ou manquante
- En cas de problème, veuillez contacter notre service après-vente
- Les instructions du fabricant doivent être respectées à tout moment
- Entretien : nettoyer avec un chiffon doux et sec. En cas de taches plus importantes, frotter soigneusement avec une éponge non abrasive légèrement humide. légèrement humide et non Abrasive
- Évitez les risques d'incendie en ne plaçant pas les meubles à proximité de sources d'inflammation ou d'objets chauds
- Ne pas sauter sur le lit

## Italiano

### IMPORTANTE! CONSERVARE PER RIFERIMENTO FUTURO: LEGGERE ATTENTAMENTE

- Deve essere assemblato da un adulto. L'assemblaggio deve essere controllato da un adulto prima dell'uso
- **ATTENZIONE!** Tenere tutte le viti, le piccole parti e i sacchetti di plastica fuori dalla portata dei bambini
- Identificare correttamente tutte le parti prima dell'assemblaggio
- Non utilizzare mai l'articolo se alcune parti sono rotte o mancanti
- In caso di problemi, si prega di contattare il nostro Servizio Post Vendita
- Le istruzioni del produttore devono essere sempre seguite
- Cura: Pulire con un panno morbido e asciutto. In caso di macchie più estese, strofinare accuratamente con una spugna leggermente umida e nonspugna leggermente umida e non abrasiva
- Evitare il rischio di incendio, non collocando i mobili vicino a fonti di accensione o a oggetti caldi
- Non saltare sul letto

## Español

### ¡ IMPORTANTE ! CONSERVELO PARA FUTURAS CONSULTAS: LEA ATENTAMENTE

- Debe ser montado por un adulto. El montaje debe ser comprobado por un adulto antes del uso
- ADVERTENCIA Mantenga todos los tornillos, piezas pequeñas y bolsas de plástico fuera del alcance de los niños.
- Identifique correctamente todas las piezas antes de montarlas
  - Nunca utilice su artículo si alguna de sus piezas está rota o falta
  - Si surge algún problema, póngase en contacto con nuestro Servicio Postventa
  - Las instrucciones del fabricante deben seguirse en todo momento
  - Cuidado: Limpiar con un paño suave y seco. En caso de manchas más grandes, frote cuidadosamente con una esponja no abrasiva ligeramente humedecida.
  - Evite el riesgo de incendio no colocando los muebles cerca de fuentes de ignición u objetos calientes.
  - No saltar sobre la cama.

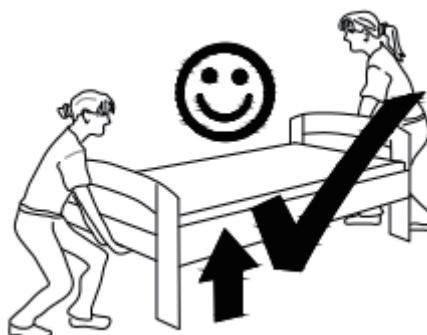
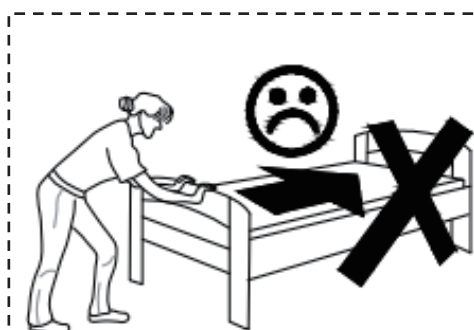

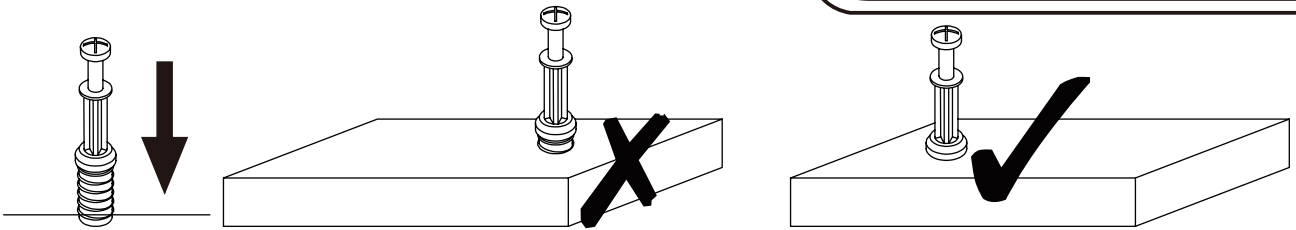

**EN\_QUICKFIT:** Tighten quickfit until shoulder is flush with panel. Do not overtighten or undertighten.

**FR\_RACCORD RAPIDE:** Faites serrer le raccord rapide jusqu'à ce que l'épaulement soit parfaitement encastré dans le panneau. Il ne faut ni trop serrer ni insuffisamment serrer.

**ES\_QUICKFIT:** Apriete quickfit hasta que el hombro se descargue con el panel. NO lo sobreapriete ni lo apriete poco.

**DE\_QUICKFIT:** Ziehen Sie den Quickfit fest, bis die Schulter mit der Platte bündig ist. Bitte nicht zu fest oder zu schwach anziehen.

**IT\_MONTAGGIO RAPIDO:** Stringere il montaggio rapido fino a quando la spalla è a filo con il pannello, non stringere troppo o troppo poco.

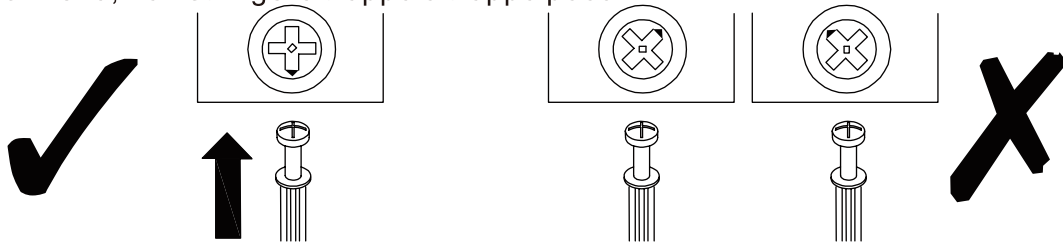

**EN\_CAM LOCK:** When fitting cam lock, ensure starting position is correct before you insert connecting quickfit.

**FR\_SERRURE BATTEUSE:** Avant d'insérer la serrure batteuse, veillez à la bonne orientation avant d'insérer le raccord rapide.

**ES\_CIERRE DE LA CÁMARA:** Cuando instale el cierre de la cámara, asegúrese de que la posición de inicio es correcta antes de que inserte el quickfit conector.

**DE\_CAM-LOCK:** Achten Sie bei der Montage des Cam-Locks auf die richtige Ausgangsposition, bevor Sie den Quickfit einsetzen.

**IT\_BLOCCAGGIO A CAMMA:** Quando si monta il bloccaggio a camma, assicurarsi che la posizione iniziale sia corretta prima di inserire il montaggio rapido di collegamento.

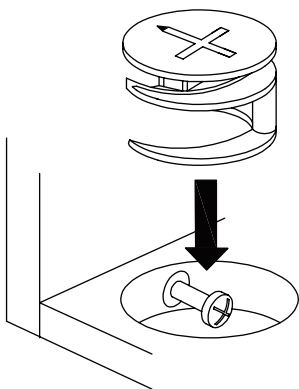

**EN\_Quickfit head** should be in the centre of the cam lock when the two panels are joined.

Cam lock should be inserted before quickfit.

**FR\_**Lorsque les deux panneaux sont assemblés, la tête du raccord rapide doit reposer au centre de la serrure batteuse.

Il faut insérer la serrure batteuse avant le raccord rapide.

**ES\_**El cabezal del quickfit debe estar en el centro del cierre de la cámara cuando se unan los dos paneles.

Se debe insertar el cierre de la cámara antes que el quickfit.

**DE\_**Der Quickfit-Kopf sollte sich in der Mitte des Cam-Locks befinden, wenn die beiden Platten zusammengefügt sind.

Der Cam-Lock sollte vor dem Quickfit eingesetzt werden.

**IT\_**La testa del montaggio rapido deve trovarsi al centro del bloccaggio a camma quando i due pannelli sono uniti.

Il Bloccaggio a Camma deve essere inserito prima del montaggio rapido.

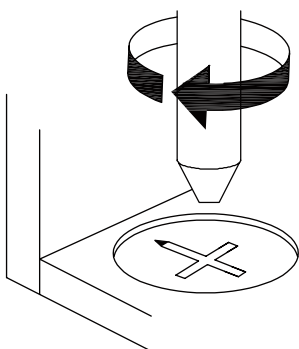

**EN\_**Turn cam lock clockwise to tighten.

**FR\_**Faites tourner la serrure batteuse dans le sens des aiguilles d'une montre pour la resserrer.

**ES\_**Gire el cierre de la cámara en sentido horario para apretarlo.

**DE\_**Drehen Sie den Cam-Lock im Uhrzeigersinn, um ihn festzuziehen.

**IT\_**Ruotare il bloccaggio a camma in senso orario per stringere.

**DE:** Vor dem Einbau die Schrauben in die Löcher stecken und festziehen, aber nicht bis 100%, 70% bis 80% anziehen reicht aus. Schließlich, nachdem alle Schrauben installiert sind, ziehen Sie alle Schrauben auf 100%. Wenn Sie auf diese Probleme stoßen, wie z. B. Fehlausrichtung der Löcher oder Unfähigkeit, bestimmte Teile zu installieren, überprüfen Sie bitte, ob die Schrauben korrekt verwendet werden und passen Sie die Dichtigkeit der Schrauben an.

**UK:** Before installation, insert the screws into the holes and tighten them, but do not tighten them to 100%, 70% to 80% is sufficient. Finally, after all screws are installed, tighten all screws to 100%. If you encounter these issues, such as if the holes cannot be aligned or some parts cannot be installed, please check if the screws are used correctly and adjust the tightness of the screws.

**FR:** Insérer la vis dans le trou avant la fin de l'assemblage, serrer la vis, mais ne pas serrer à 100%, 70% ~ 80% est correct. Enfin, une fois que toutes les vis sont bien serrées, toutes les vis sont serrées à 100%. Si vous rencontrez ces problèmes, par exemple si les trous ne sont pas alignés ou si certaines pièces ne peuvent pas être montées, vérifiez que les vis sont utilisées correctement et Ajustez leur serrage.

# Detailansicht

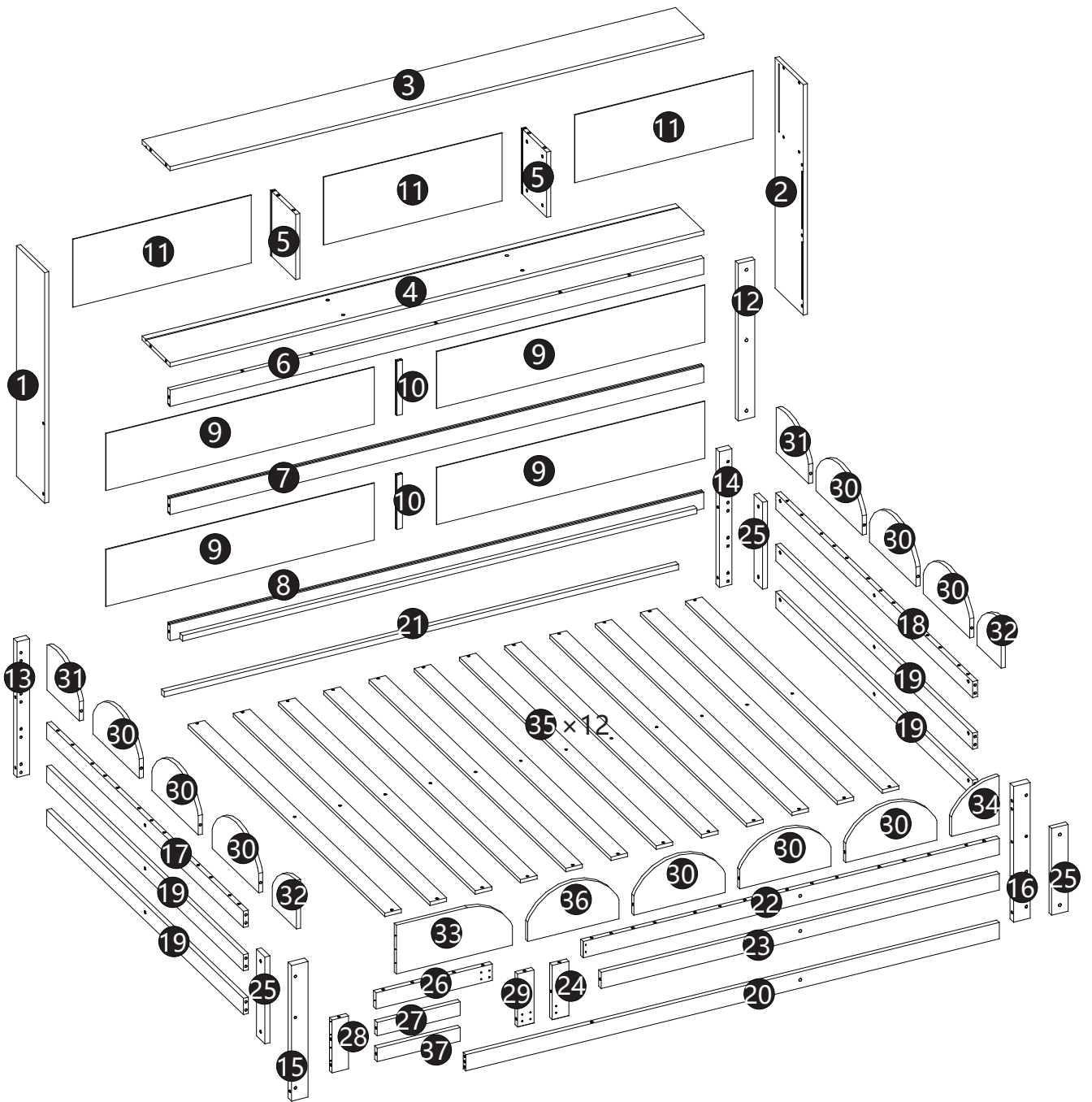

# N616P465403

① x 1

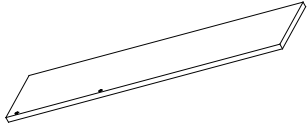

② x 1

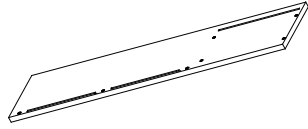

③ x 1

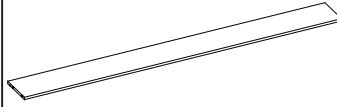

④ x 1

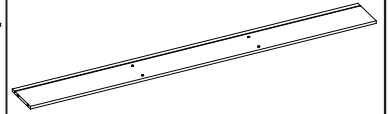

⑥ x 1

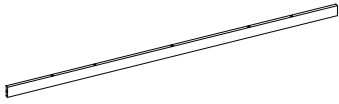

⑦ x 1



⑧ x 1



⑨ x 4

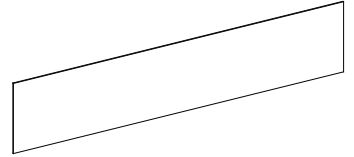

⑱ x 4

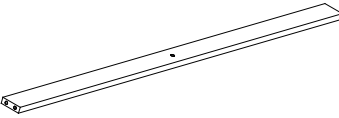

⑳ x 1



㉑ x 1



㉒ x 1

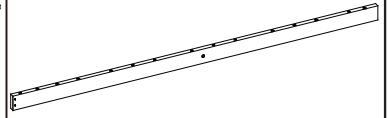

㉓ x 1

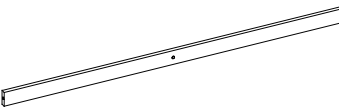

# N616P465404

5 x 2

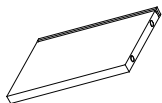

10 x 2



11 x 3

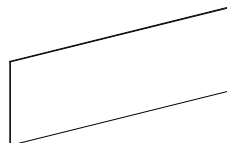

12 x 1

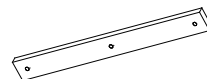

13 x 1

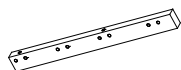

14 x 1

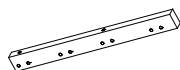

15 x 1

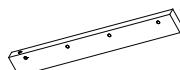

16 x 1

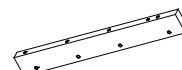

17 x 1

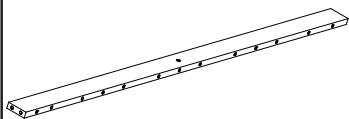

18 x 1

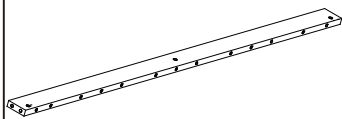

24 x 1



25 x 3

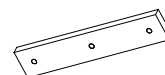

26 x 1

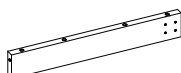

27 x 1



28 x 1



29 x 1



30 x 9

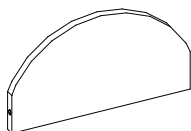

31 x 2



32 x 2

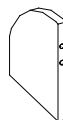

33 x 1

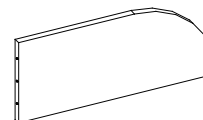

34 x 1

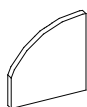

35 x 12

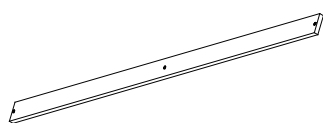



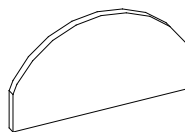







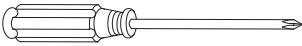



36 x 1



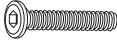

37 x 1

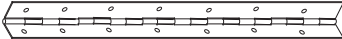
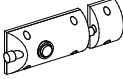

# N616P465403

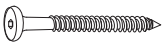

<b>A</b> 	<b>B</b> 	<b>C</b> 
(1pc)	Φ8*30mm(50pcs)	(21pcs)
<b>D</b> 	<b>E</b> 	<b>F</b> 
(21pcs)	(120pcs)	Φ6*60mm(4pcs)
<b>G</b> 	<b>H</b> 	<b>J</b> 
M6*60mm(12pcs)	Φ10*10mm(20pcs)	M6*25mm(9pcs)
<b>K</b> 	<b>L</b> 	<b>M</b> 
M6*15mm(9pcs)	M4(2pcs)	Φ6*90mm(37pcs)
<b>N</b> 	<b>P</b> 	<b>Q</b> 
M6*100mm(8pcs)	Φ4*30mm(39pcs)	Φ3*16mm(26pcs)
<b>R</b> 	<b>S</b> 	
(1pc)	(2pcs)	

<b>F</b>		<b>M</b>	
	Φ6*60mm		Φ6*90mm

**DE:**Bitte beachten Sie, dass die Formen der Schrauben F und M ähnlich sind. Bitte installieren Sie entsprechend der Anleitung und unterscheiden Sie sie!

**UK:**Please note that the shapes of screws F and M are similar. Please install according to the instructions and distinguish them!



**FR:**Notez que les vis F et M ont des formes similaires. Veuillez les installer en suivant les instructions pour les séparer!

<b>G</b>		<b>N</b>	
	M6*60mm		M6*100mm

**DE:**Bitte beachten Sie, dass die Formen der Schrauben G und N ähnlich sind. Bitte installieren Sie entsprechend der Anleitung und unterscheiden Sie sie!

**UK:**Please note that the shapes of screws G and N are similar. Please install according to the instructions and distinguish them!

**FR:**Notez que les vis G et N ont des formes similaires. Veuillez les installer en suivant les instructions pour les séparer!



<b>P</b>		<b>Q</b>	
	Φ4*30mm		Φ3*16mm

**DE:**Bitte beachten Sie, dass die Formen der Schrauben P und Q ähnlich sind. Bitte installieren Sie entsprechend der Anleitung und unterscheiden Sie sie!

**UK:**Please note that the shapes of screws P and Q are similar. Please install according to the instructions and distinguish them!



**FR:**Notez que les vis P et Q ont des formes similaires. Veuillez les installer en suivant les instructions pour les séparer!

# 1

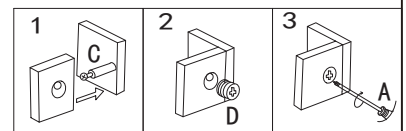
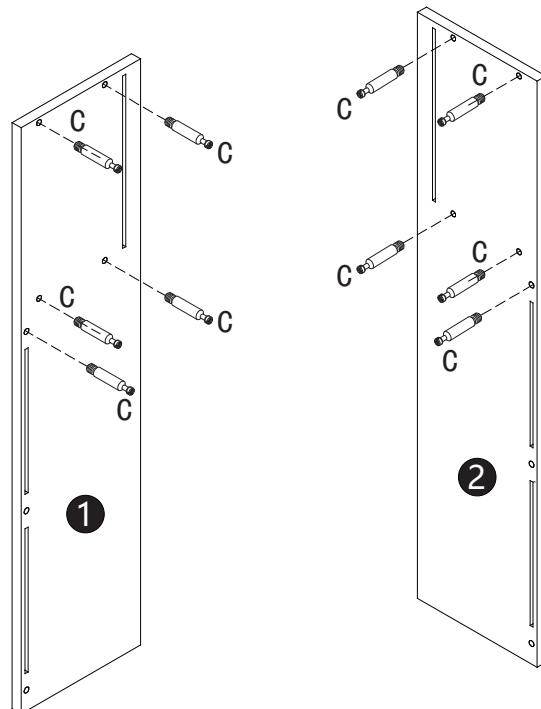
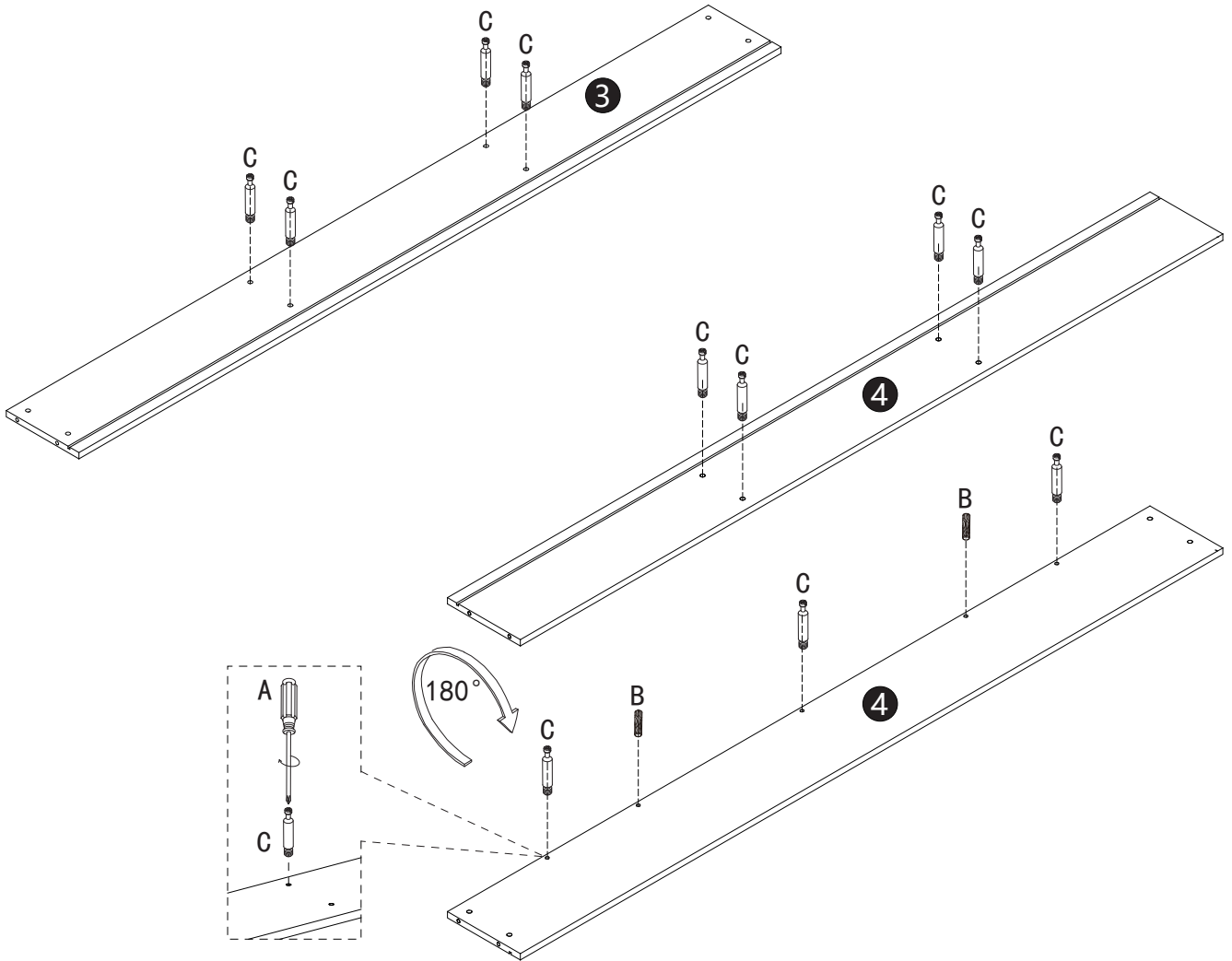
<b>A</b>		<b>C</b>		<b>B</b>	
<b>1PC</b>		<b>21PCS</b>		<b>2PCS</b>	



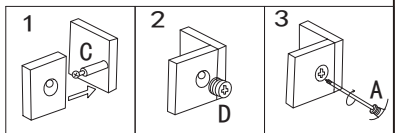
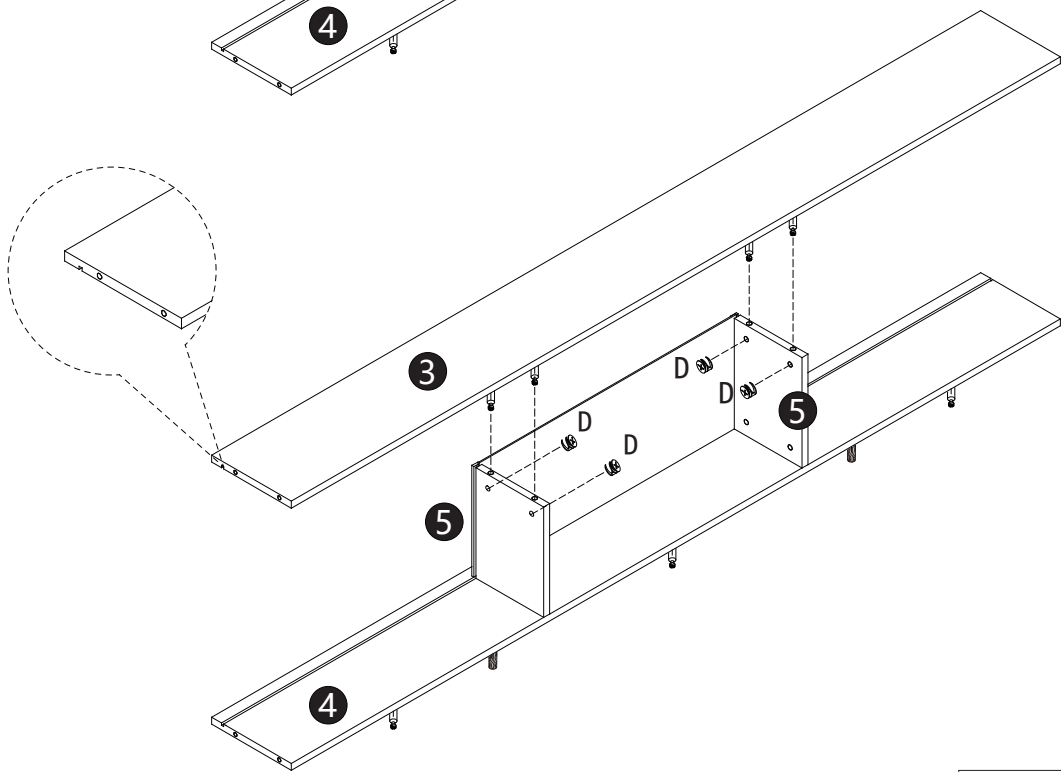
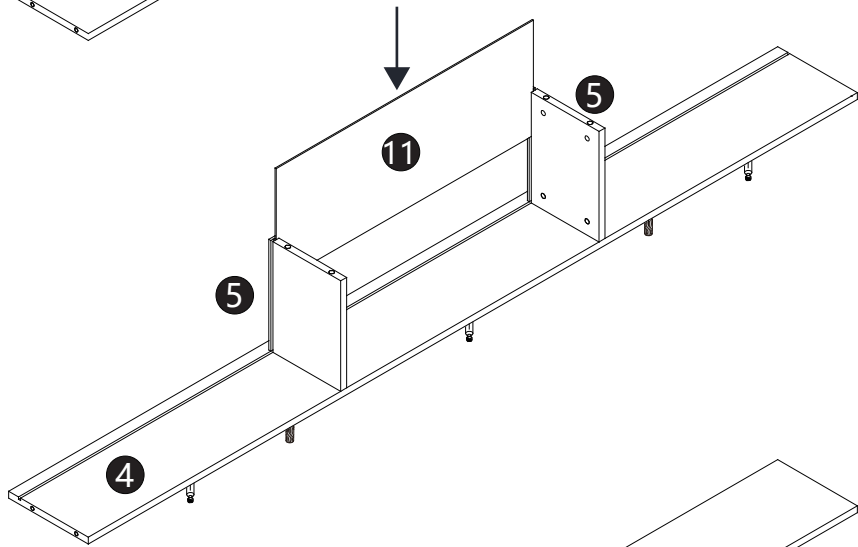
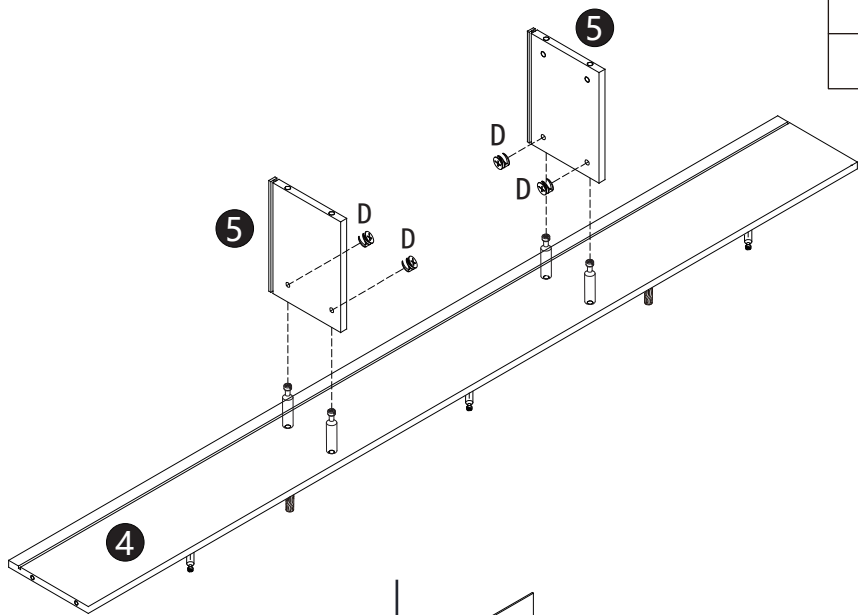

2

A		D	
1PC		8PCS	



3

A		D	
1PC		3PCS	

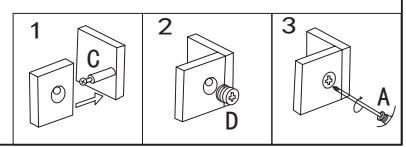
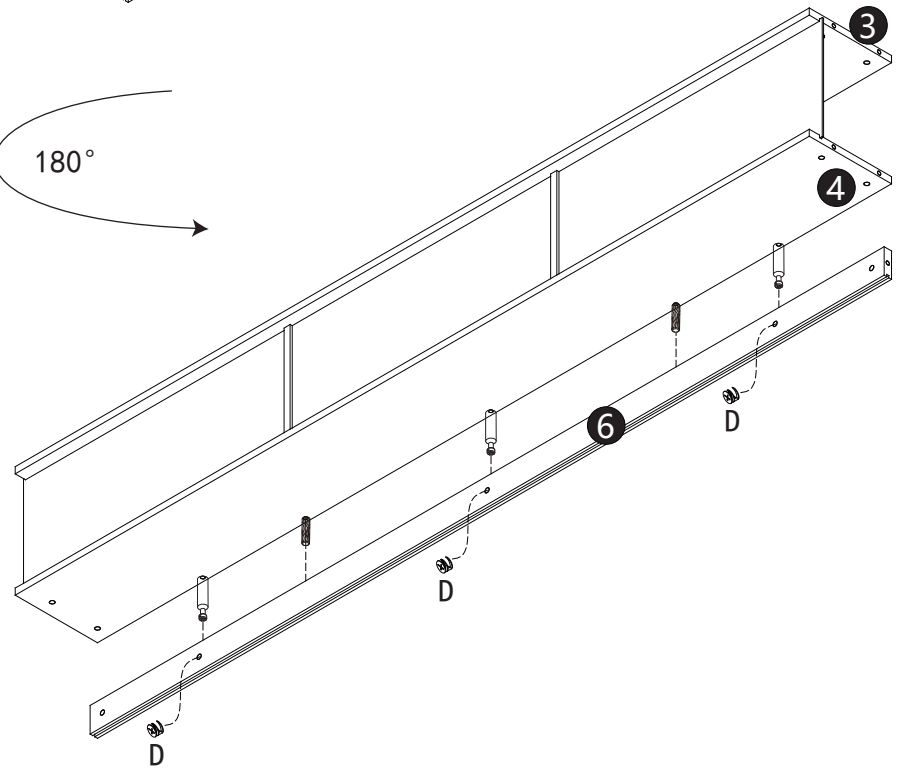
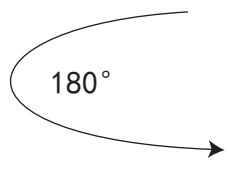
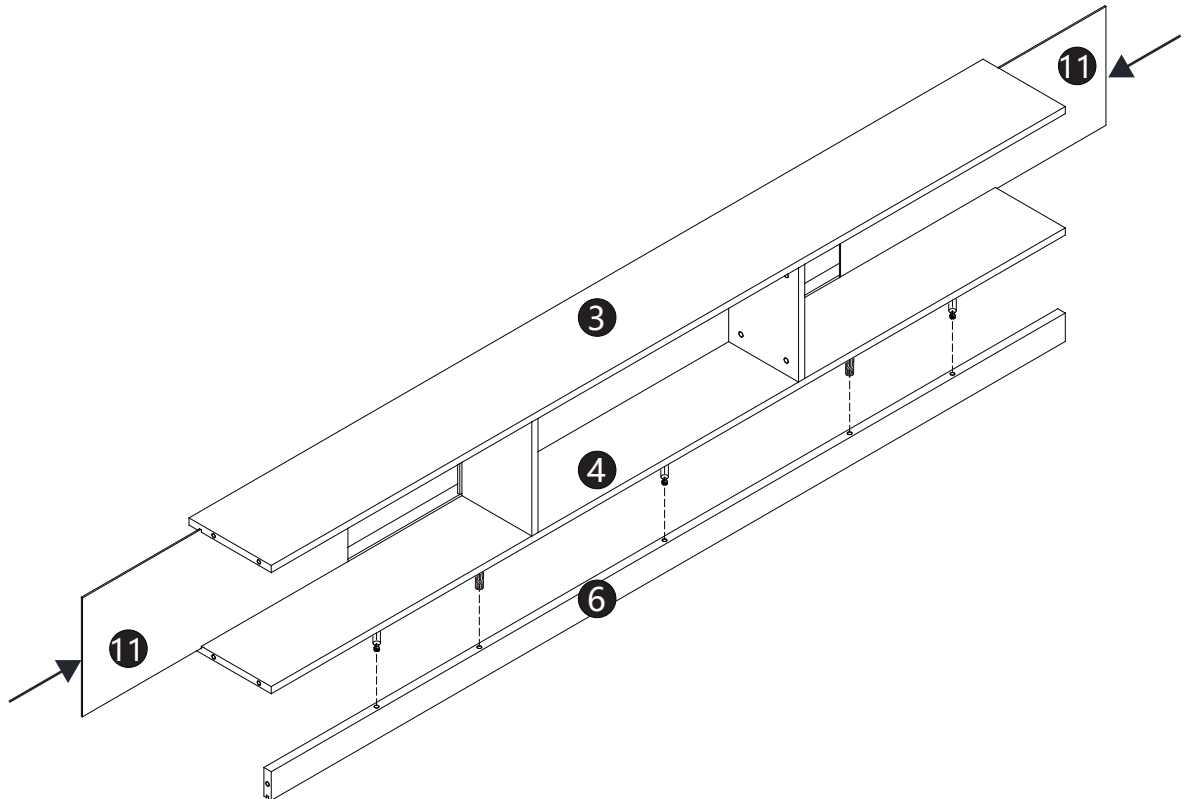









4

B		F		G		H	
21PCS		2PCS		6PCS		6PCS	
J		K		L		M	
3PCS		3PCS		2PCS		8PCS	





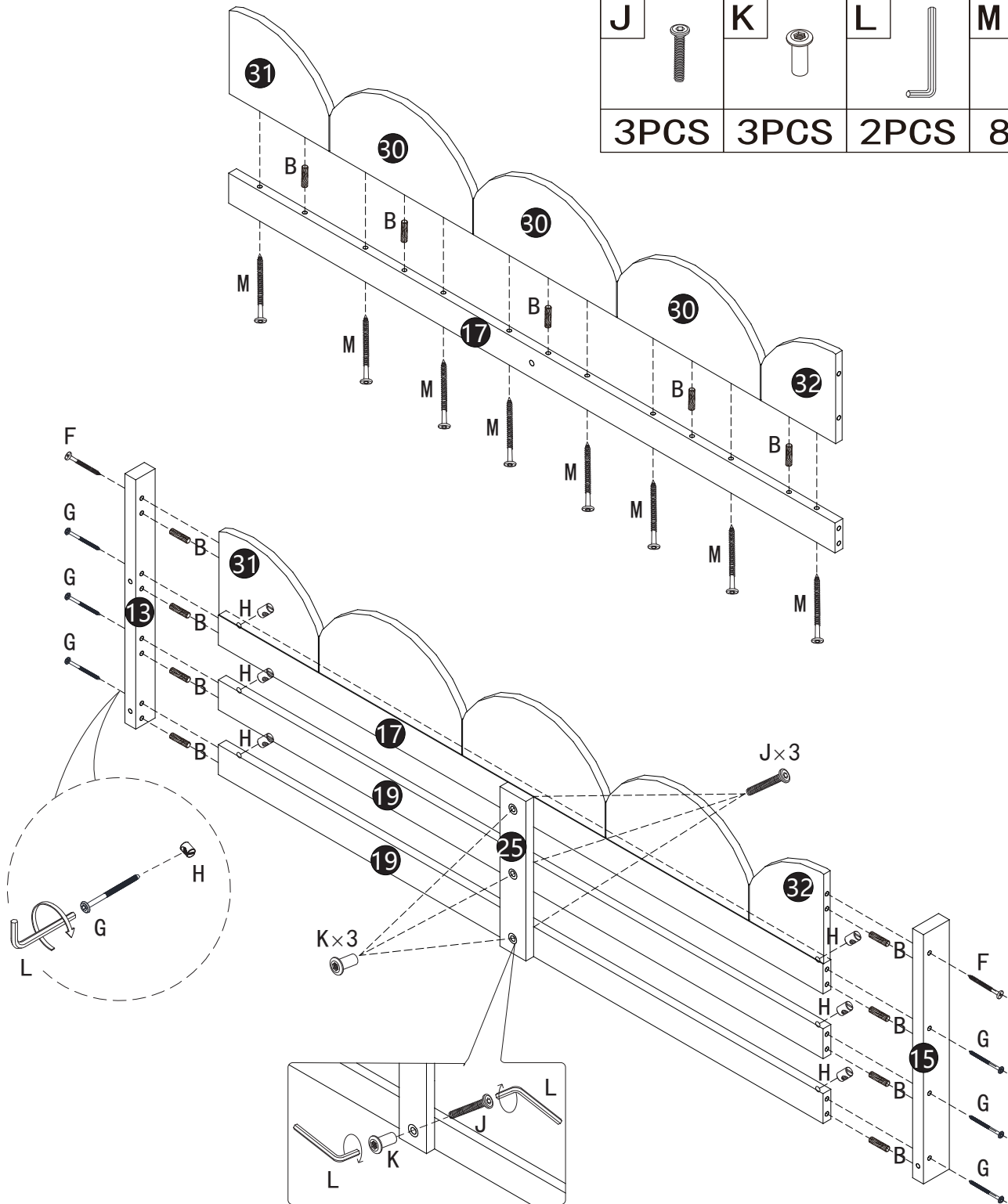

G		N	
	M6*60mm		M6*100mm
F		M	
	Φ6*60mm		Φ6*90mm

# 5





<b>B</b>		<b>F</b>		<b>G</b>		<b>H</b>	
<b>13PCS</b>		<b>2PCS</b>		<b>6PCS</b>		<b>6PCS</b>	
<b>J</b>		<b>K</b>		<b>L</b>		<b>M</b>	
<b>3PCS</b>		<b>3PCS</b>		<b>2PCS</b>		<b>8PCS</b>	





<b>G</b>		<b>N</b>	
M6*60mm		<del>M6*100mm</del>	

<b>F</b>		<b>M</b>	
Φ6*60mm		Φ6*90mm	

# 6

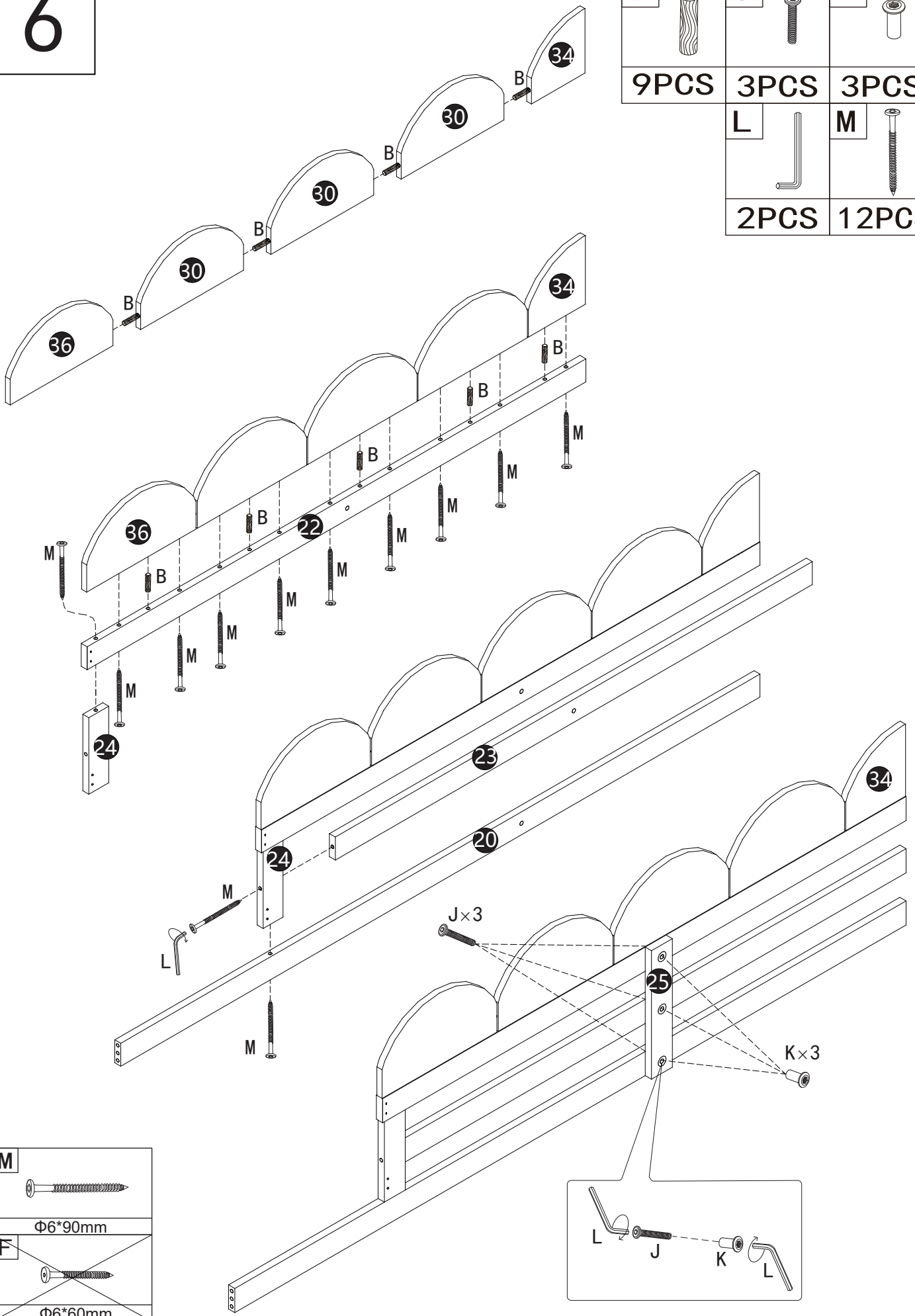

<b>B</b>		<b>J</b>		<b>K</b>	
<b>9PCS</b>		<b>3PCS</b>		<b>3PCS</b>	
		<b>L</b>		<b>M</b>	
		<b>2PCS</b>		<b>12PCS</b>	

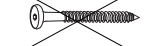

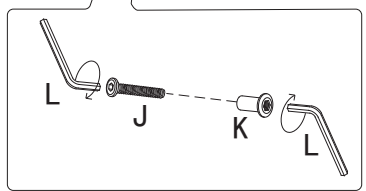
<b>M</b>	
	Φ6*90mm
<b>F</b>	
	Φ6*60mm





7

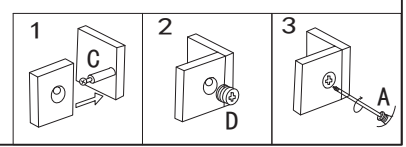
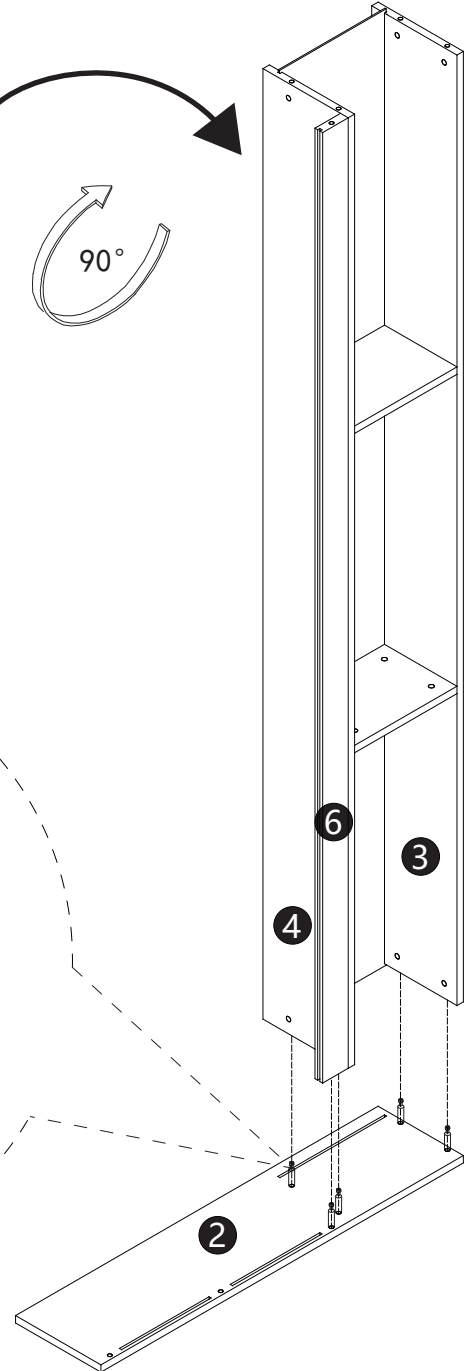
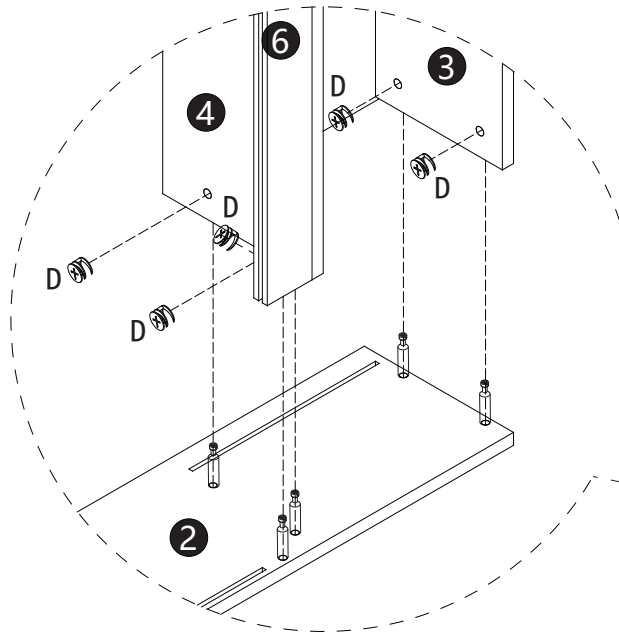
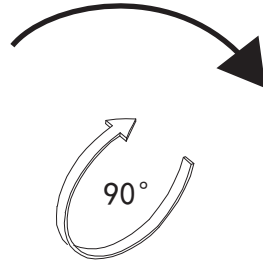
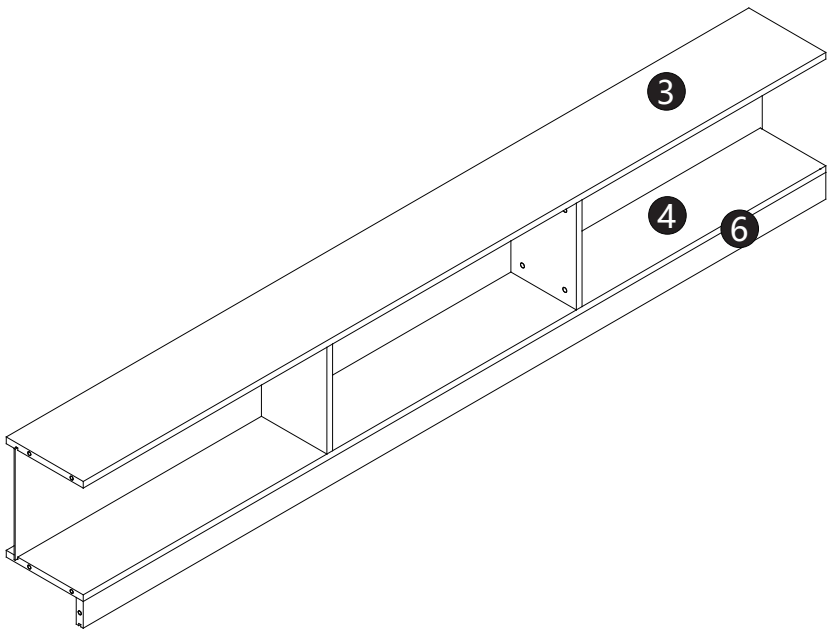

A		D	
1PC		5PCS	





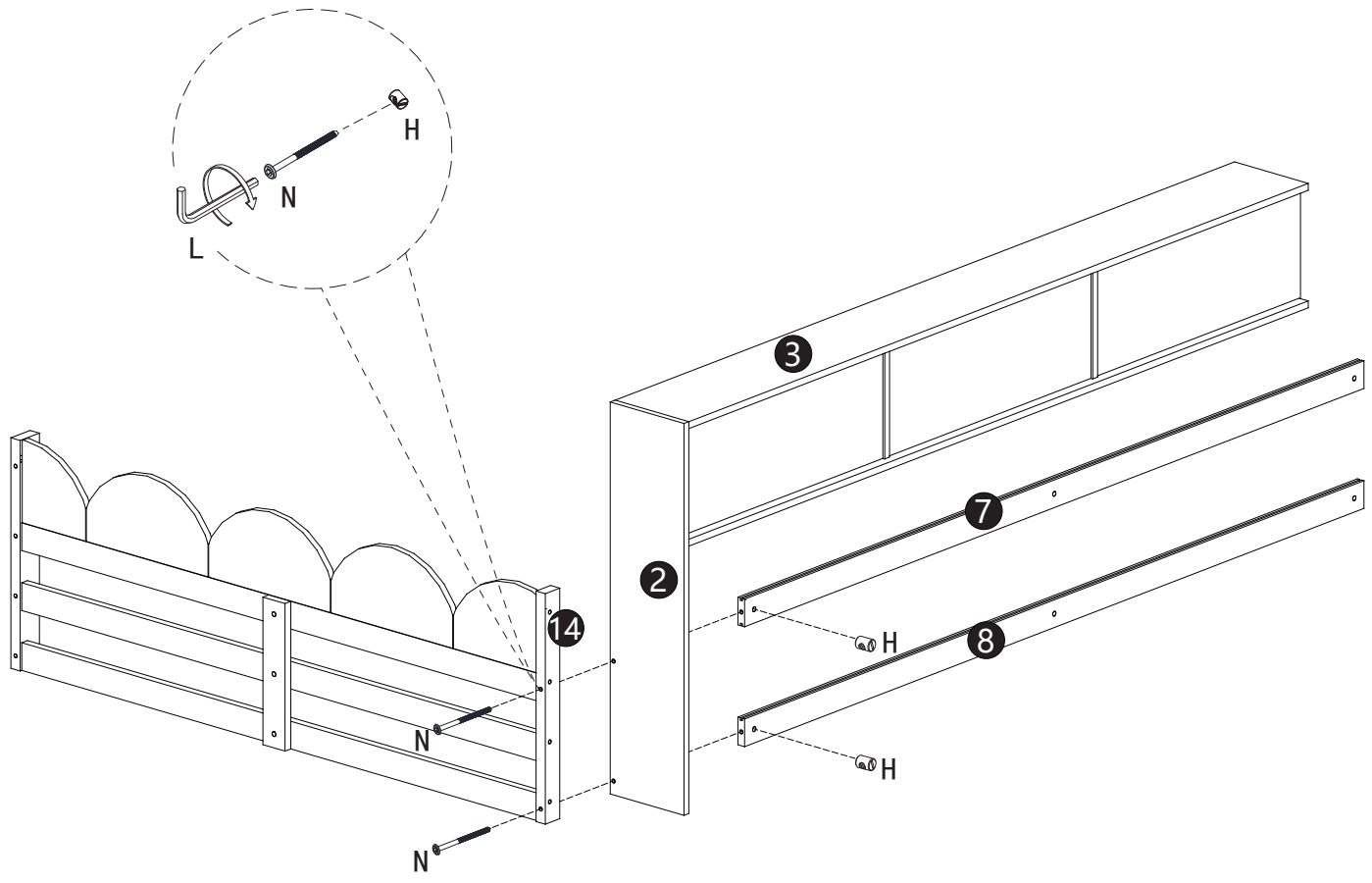

8

H		L		N	
2PCS		1PC		2PCS	





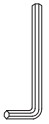

<del>G</del>	<del></del>	N	
<del>M6*60mm</del>		M6*100mm	

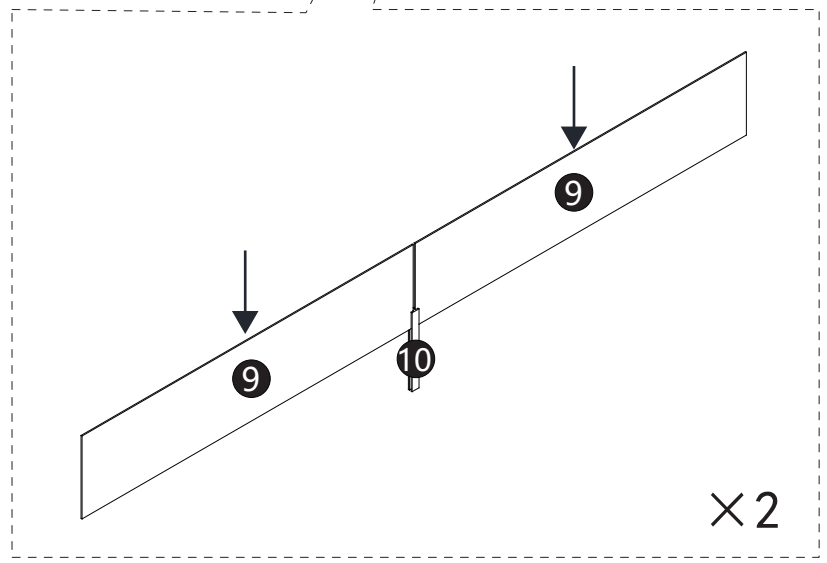
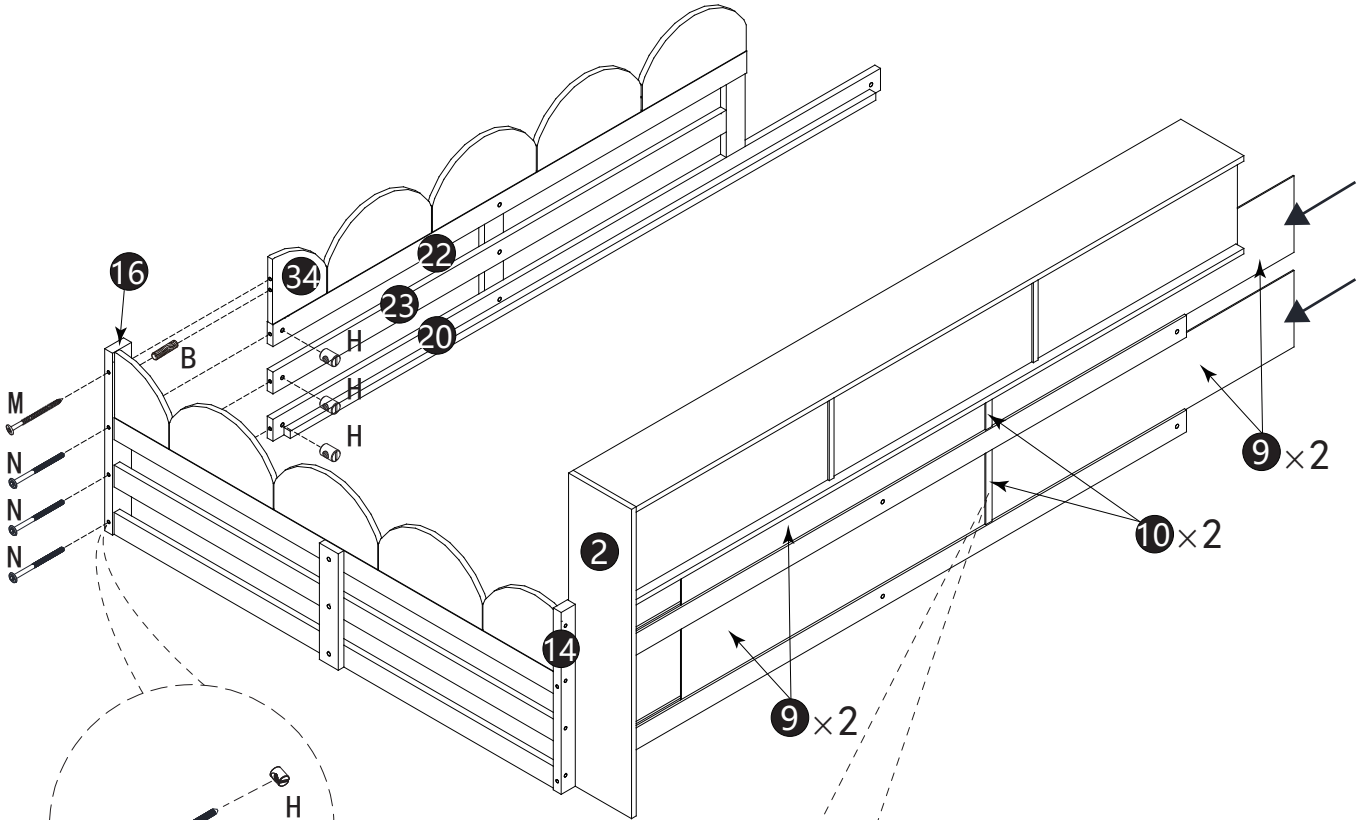
# 9

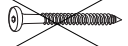





<b>B</b>		<b>H</b>		<b>L</b>	
<b>1 PC</b>		<b>3 PCS</b>		<b>1 PC</b>	
		<b>M</b>		<b>N</b>	
		<b>1 PC</b>		<b>3 PCS</b>	





<b>F</b>		<b>M</b>	
	$\Phi 6 \times 60 \text{mm}$		$\Phi 6 \times 90 \text{mm}$

<b>G</b>		<b>N</b>	
	$M 6 \times 60 \text{mm}$		$M 6 \times 100 \text{mm}$

# 10

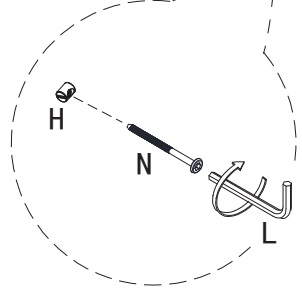
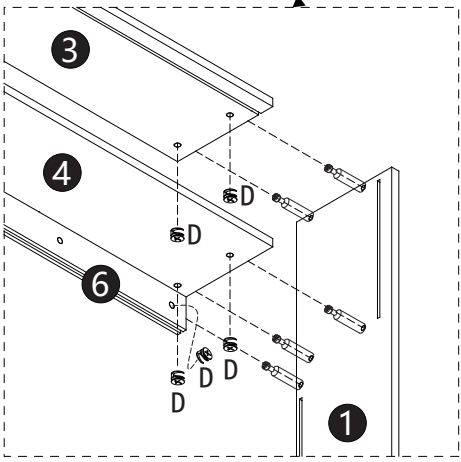
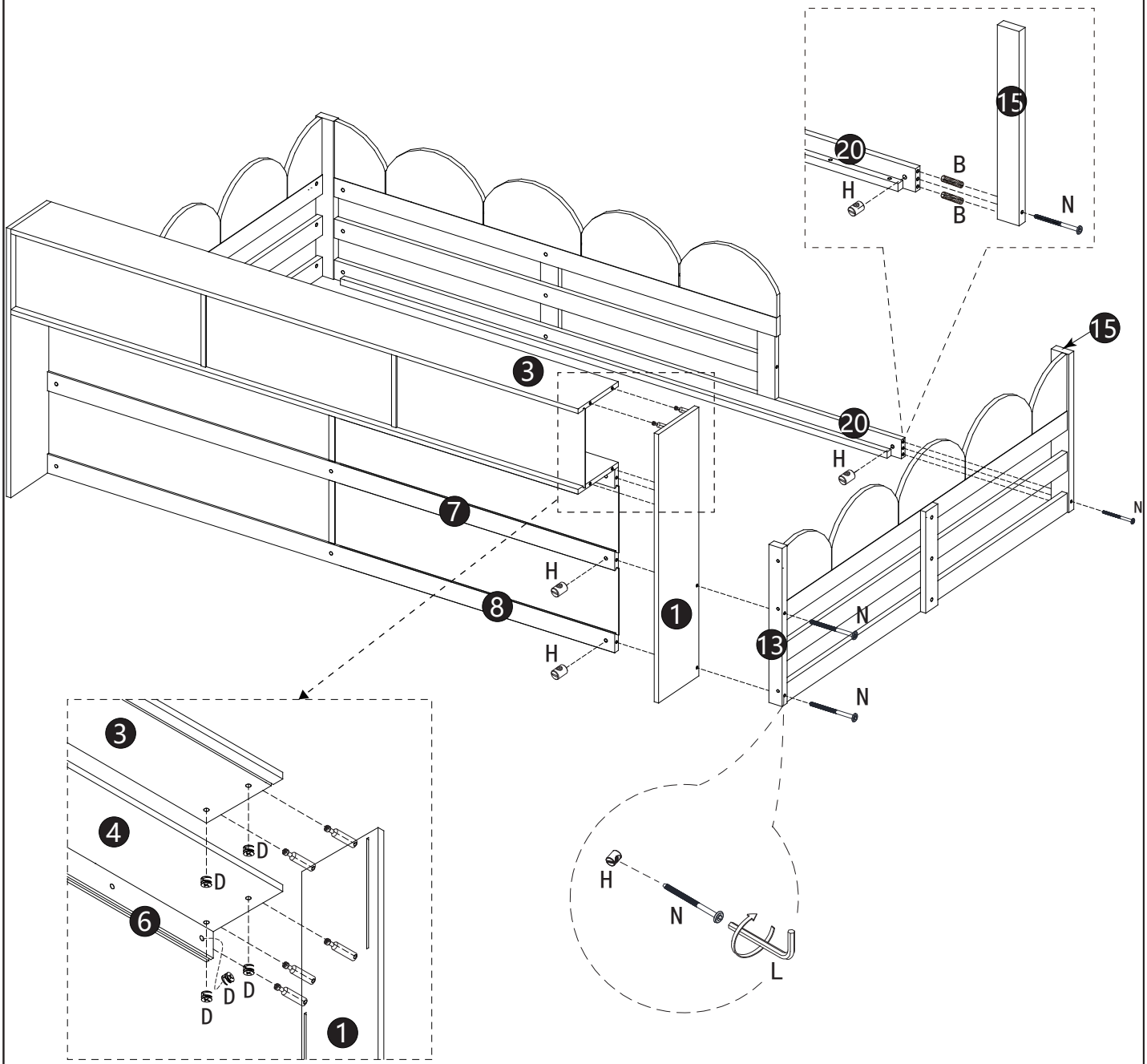

<b>A</b>		<b>D</b>		<b>H</b>	
<b>1PC</b>		<b>5PCS</b>		<b>3PCS</b>	
<b>B</b>		<b>L</b>		<b>N</b>	
<b>2PCS</b>		<b>1PC</b>		<b>3PCS</b>	

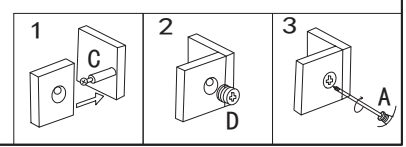

<b>G</b>		<b>N</b>	
	M6*60mm		M6*100mm





# 11

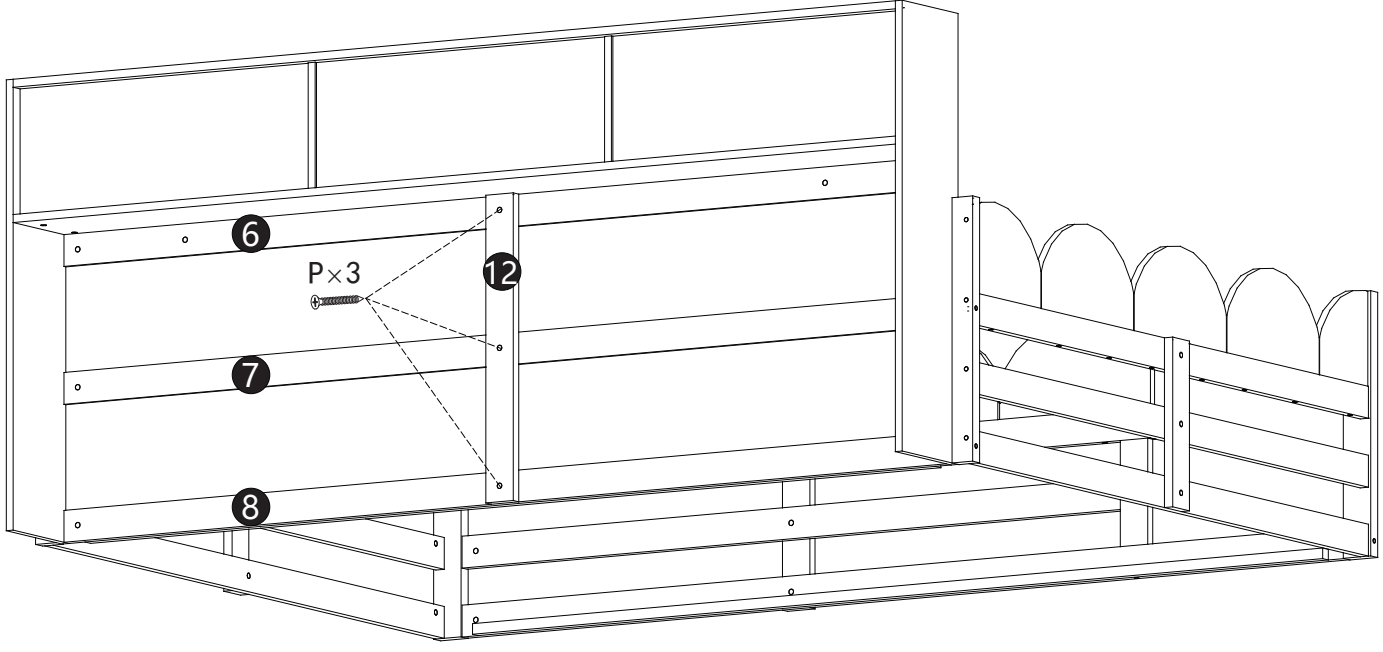

<b>A</b>		<b>P</b>	
	<b>1PC</b>		<b>3PCS</b>





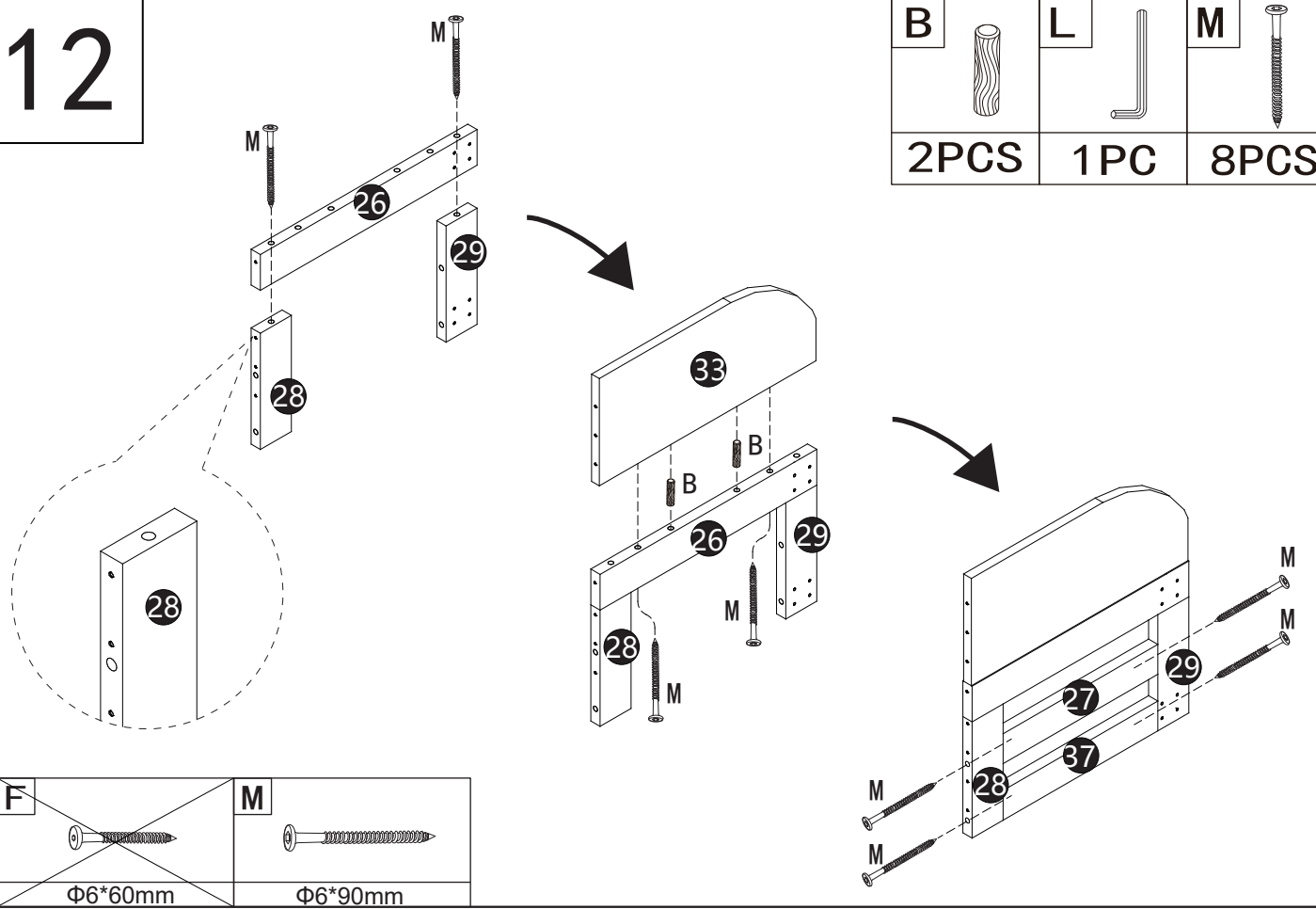

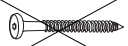
# 12

<b>B</b>		<b>L</b>		<b>M</b>	
	<b>2PCS</b>		<b>1PC</b>		<b>8PCS</b>





<b>F</b>		<b>M</b>	
	$\Phi 6 \times 60\text{mm}$		$\Phi 6 \times 90\text{mm}$

# 13

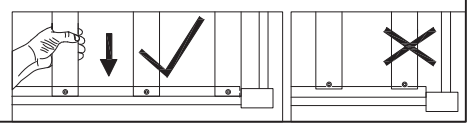
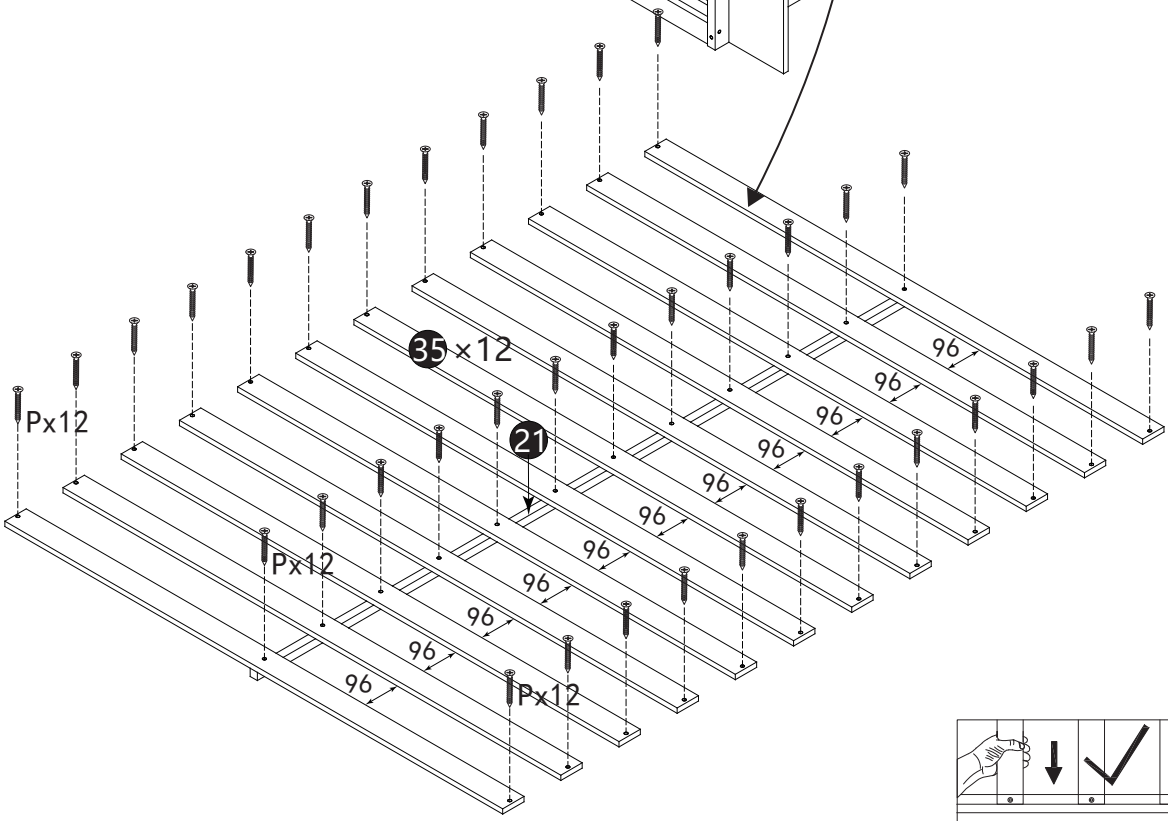
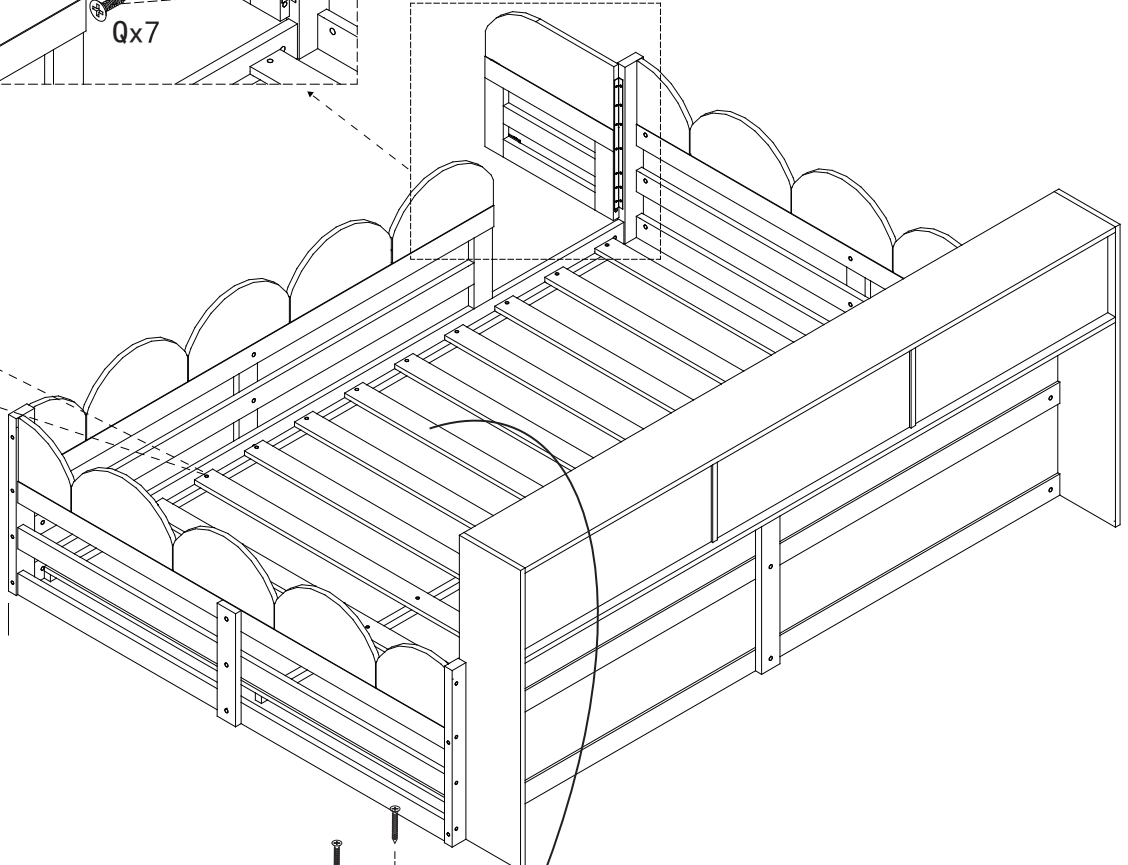
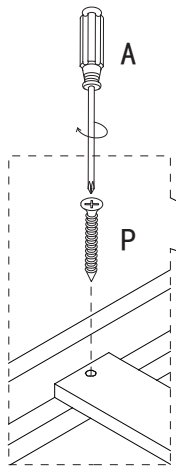
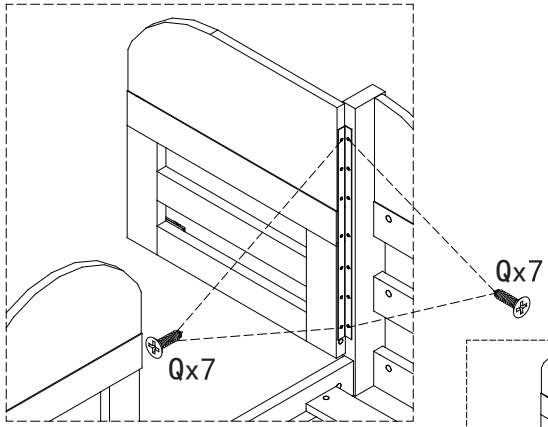

<b>A</b> 	<b>P</b> 	<b>Q</b> 
<b>1 PC</b>	<b>36 PCS</b>	<b>14 PCS</b>
<b>R</b> 		
<b>1 PC</b>		

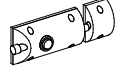

# 14

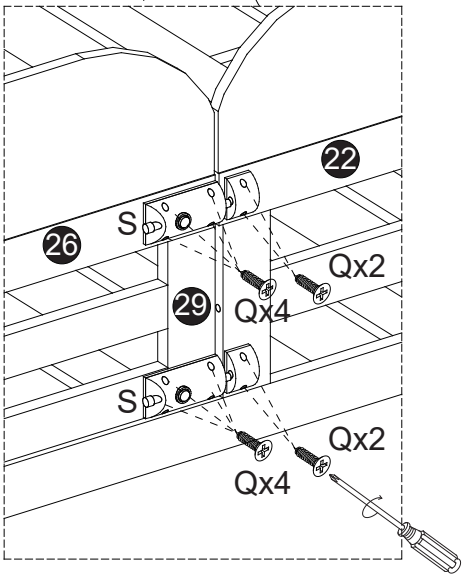
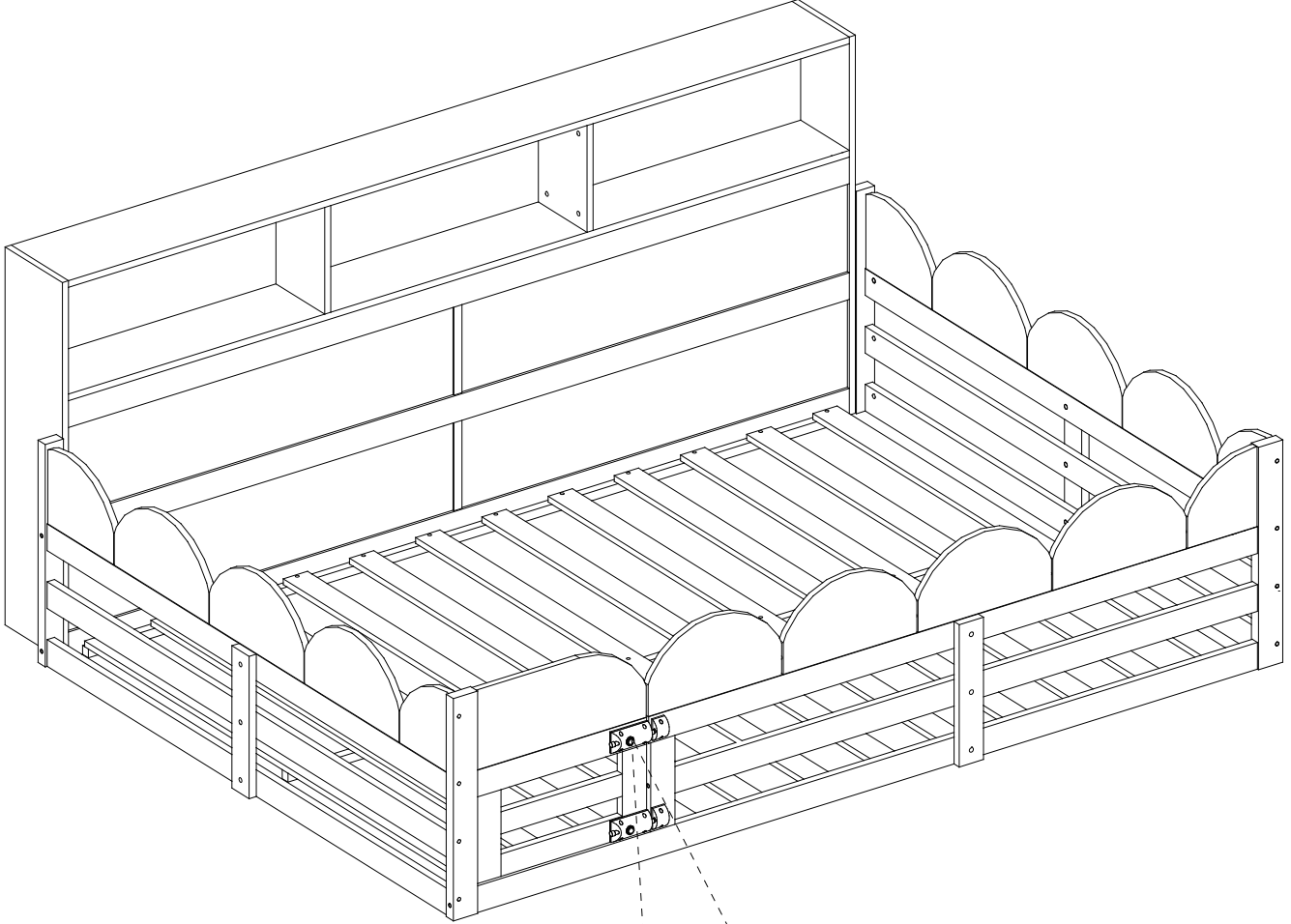
A		Q		S	
1 PC		12 PCS		2 PCS	



<del>P</del>	Q
<del></del>	
<del>Φ4*30mm</del>	Φ3*16mm

15

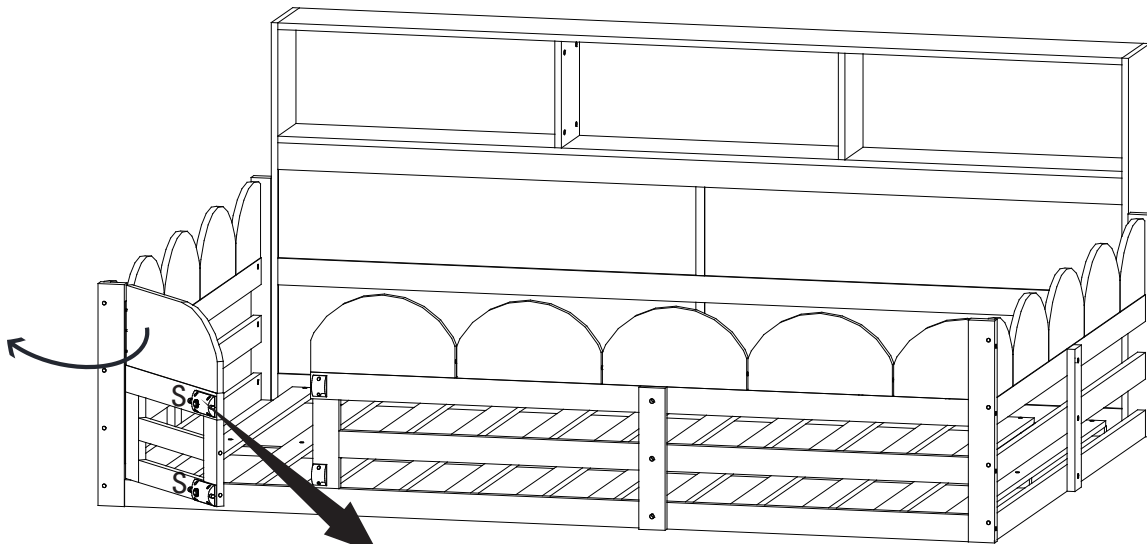
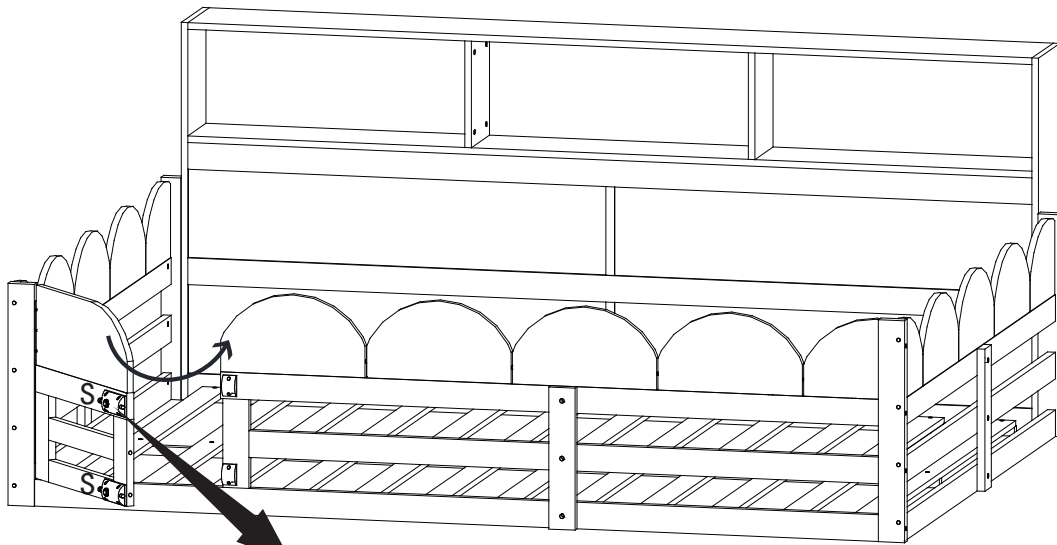

# 16

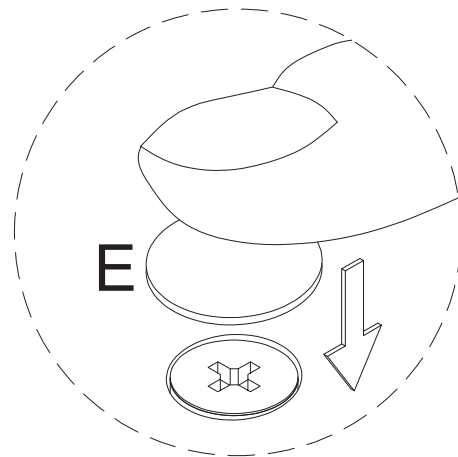
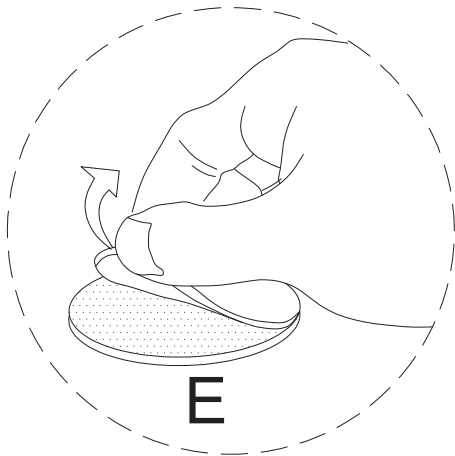
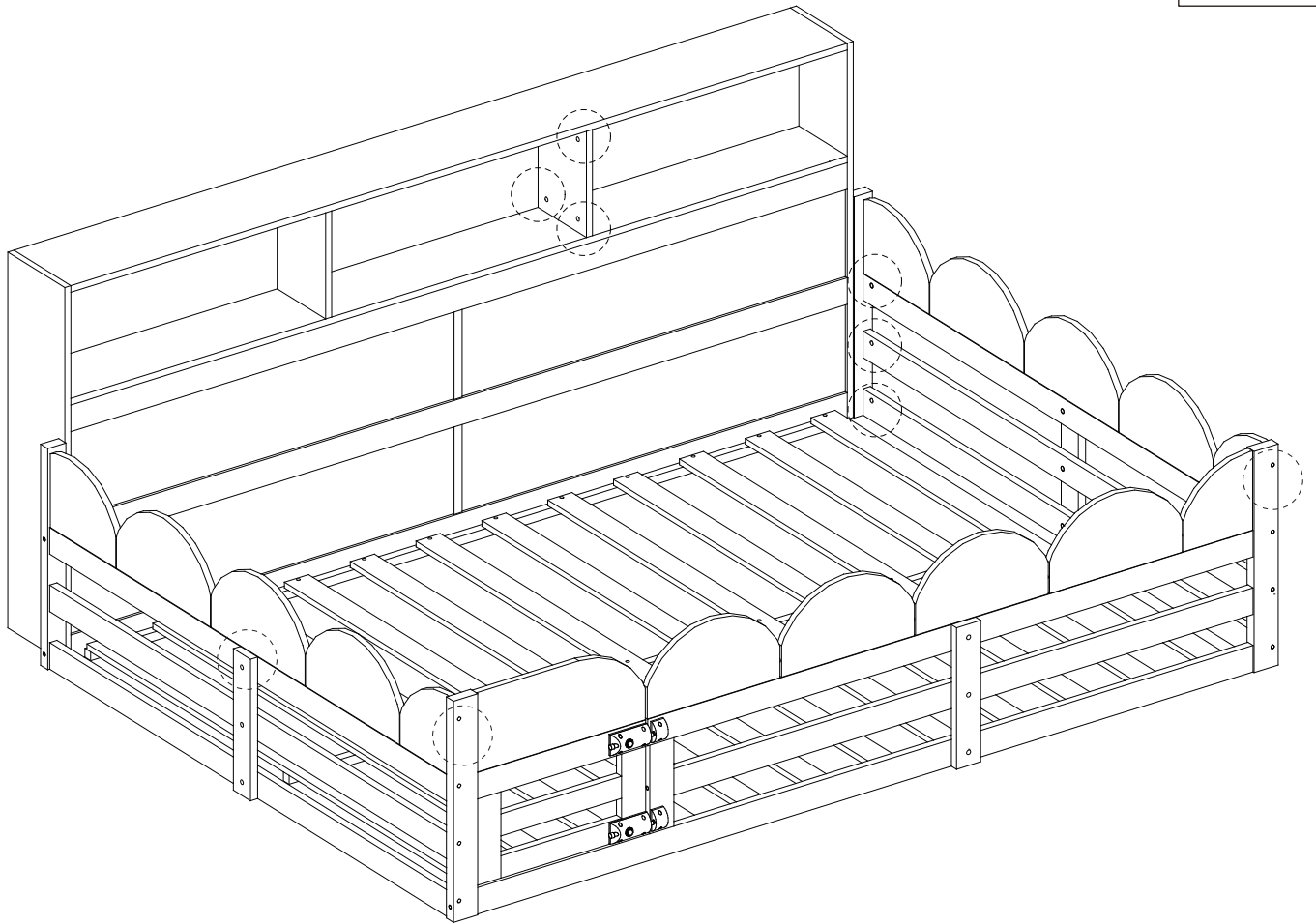
**E****120PCS**

EN: Cover all exposed holes with hole stickers.

DE: Decken Sie alle offenliegenden Öffnungen mit Lochaufklebern zu.

FR: Couvrez tous les trous visibles avec des cache-trous.

IT: Coprire tutti i fori visibili con adesivi copri-fori.

ES: Cubra todos los orificios visibles con pegatinas tapagujeros.