

FR Description du produit

EN Product description

ES Descripción del producto

DE Produktbeschreibung

IT Descrizione del prodotto

NL Productomschrijving

PT Descrição do produto

TILKI

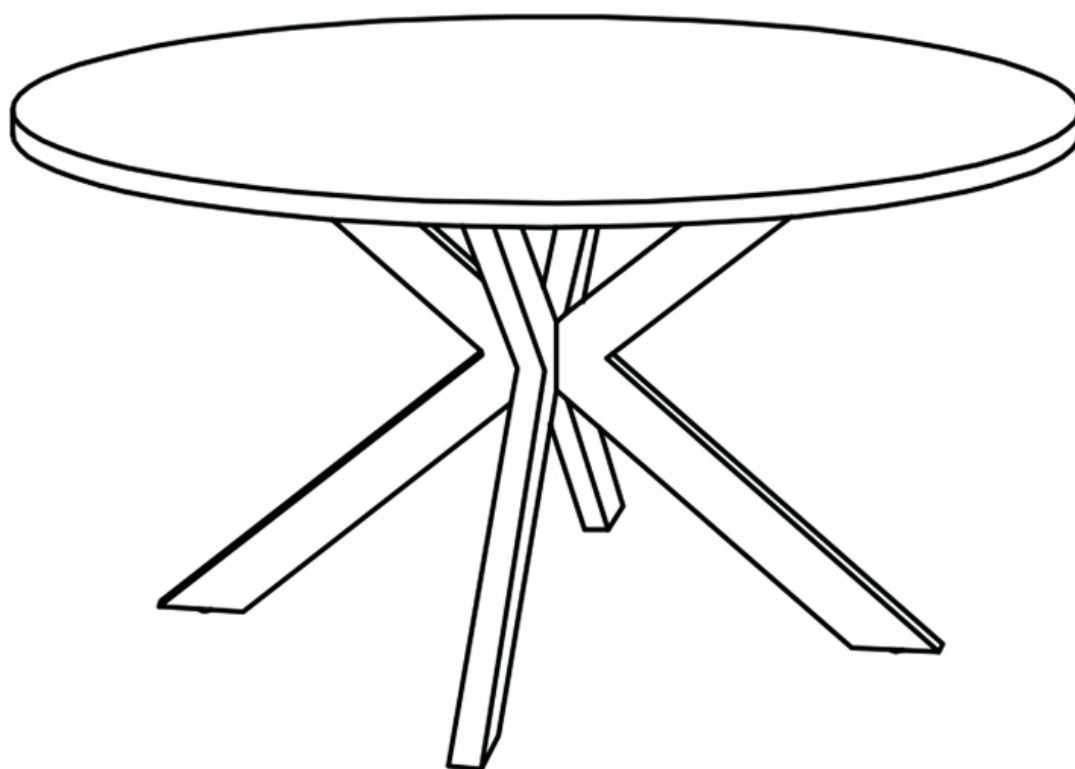

Meuble à usage domestique / Domestic furniture / Meuble a uso domestico / Möbel für den häuslichen Wohngebrauch/
Mobili per la casa/ Huishoudmeubilair / Mobiliário doméstico

3517920931309 175283NATU



1. Repérez les pièces constituant votre meuble.
2. Regroupez et comptez la quincaillerie.
3. Munissez-vous de l'outillage nécessaire.
4. Aménagez-vous une zone de montage, la moquette ou une couverture protégera des rayures.
5. Procédez au montage, ne jamais forcer sur les assemblages, resserrez les vis après quelques temps d'usage.



FR

Gardez votre notice de montage.
Si une pièce venait à manquer elle sera le moyen le plus clair pour communiquer avec votre magasin.
Nous conseillons d'aérer la pièce lors du montage et quelques heures après.

1. Identify the parts which make up your piece of furniture.
2. Gather the hardware parts and count them.
3. Have the necessary tools ready.
4. Organize a space for assembly, wall carpeting or a blanket will protect the furniture against scratches.
5. Mount the furniture, never force the parts to be assembled.



EN

Tighten the screws after it has been used for some time.
Keep the assembly instruction since it will help you when you get in touch with the store if a part should be missing.
We advise ventilating the room during installation and during few hours after.

1. Localice las piezas que componen su mueble.
2. Reagrupe y cuente la tornilleria.
3. Prepare las herramientas necesarias.
4. Prepare una zona de montaje, la moqueta o una manta protegerá de arañazo.
5. Proceda al montaje, no forzar sobre los embalages, apretar los tornillos después de algún tiempo de uso.



ES

Guardar las instrucciones de montaje.
Si una pieza le faltase, sera la manera mas facil de comunicarse con su proveedor.
Aconsejamos ventilar la zona durante la instalación y algunas horas después.

1. Bitte überprüfen Sie, ob alle Einzelteile Ihres Möbelstücks vorhanden sind.
2. Bitte überprüfen Sie, ob alle Schrauben und Verbindungsteile für die Montage vorhanden sind.
3. Halten sie alle notwendigen Montage-Werkzeuge für ihren Einsatz gebrauchsbereit.
4. Bereiten Sie einen passenden Ort für die Montage vor. Ein Teppichboden oder ähnliches schützt vor Kratzern.
5. Beginnen Sie mit der Montage. Lassen Sie sich Zeit und fügen Sie die Einzelteile nie mit Gewalt zusammen.



DE

Um einen langfristigen und einwandfreien Gebrauch zu gewährleisten, ziehen Sie die einzelnen Schrauben regelmäßig nach längerer Nutzung des Möbelstücks fest.
Bitte bewahren Sie diese Montageanleitung auf. Diese gewährleistet im Problemfall einen reibungslosen und schnellen Kommunikationsaustausch mit dem Kundenservice Ihres Geschäfts.
Wir beraten, lüften Sie den Raum während der Installation und ein paar Stunden später.

1. Identificare le parti che compongono il mobile.
2. Raccogliere le parti e contarle.
3. Tenere pronti gli attrezzi necessari.
4. Organizzare uno spazio per il montaggio, un telo da parete o una coperta proteggerà i mobili contro i graffi.
5. Montare il mobile, non forzare mai le parti da assemblare.



IT Serrare le viti dopo che sono state usate per un certo periodo di tempo.
Conservare le istruzioni di montaggio poiché vi torneranno utili quando ricontatterete il negozio se una parte dovesse mancare.

Si consiglia di ventilare la stanza durante l'installazione e durante le ore successive.

1. Identificeer de onderdelen waar uw stuk meubilair uit bestaat.
2. Verzamel de hardwareonderdelen en tel deze.
3. Heb het vereiste gereedschap bijdehand.
4. Organiseer een ruimte voor assemblage; muurtapijt of een deken zal het meubilair beschermen tegen krassen.
5. Monteer het meubilair en forceer hierbij nooit de te monteren onderdelen.



NL Draai de schroeven vast nadat het een tijdje in gebruik is geweest.
Bewaar de assemblage-instructies in het geval dat u contact op moet nemen met de winkel indien er een onderdeel ontbreekt.

Wij raden u aan de kamer te ventileren tijdens en voor enkele uren na de installatie.

1. Identifique as peças que constituem a sua mobília.
2. Junte as ferragens e conte.
3. Tenha prontas as ferramentas necessárias.
4. Organize e arranje espaço para a montagem, colocando um tapete ou manta para proteger a mobília contra riscos.
5. Monte a mobília, nunca force as peças a montar.



PT Aperte os parafusos após a peça de mobília ter sido utilizada durante algum tempo.
Guarde as instruções de montagem, pois serão úteis quando quiser contactar a loja, caso perca alguma peça.
Aconselhamos a ventilar a divisão durante a instalação e algumas horas depois.

**IMPORTANT, A CONSERVER POUR UNE
REFERENCE ULTERIEURE: LIRE
ATTENTIVEMENT**

**IMPORTANT, RETAIN FOR FUTURE REFERENCE:
READ CAREFULLY**

IMPORTANTE, CONSERVAR PARA FUTURAS

CONSULTAS: LEER ATENTAMENTE

**WICHTIG, FÜR SPÄTERES NACHSCHLAGEN
AUFBEWAHREN: SORGFÄLTIG LESEN**

**IMPORTANTE, CONSERVARE PER RIFERIMENTO
FUTURO, LEGGERE CON ATTENZIONE**





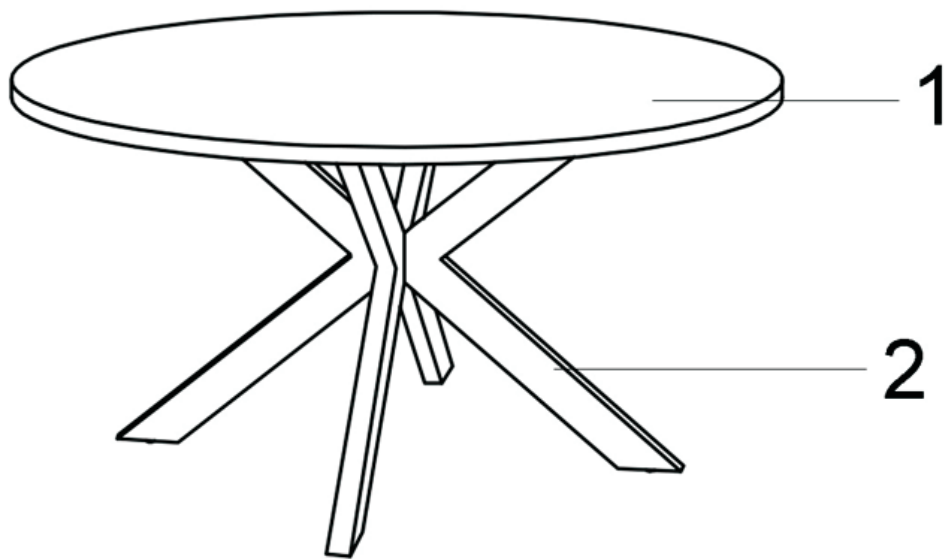

**BELANGRIJK, BEWAARALS EVENTUEEL
NASLAGWERK, ZORGVULDIG LEZEN**

**IMPORTANTE, GUARDAR PARA REFERÊNCIA
FUTURA, LER ATENTAMENTE**





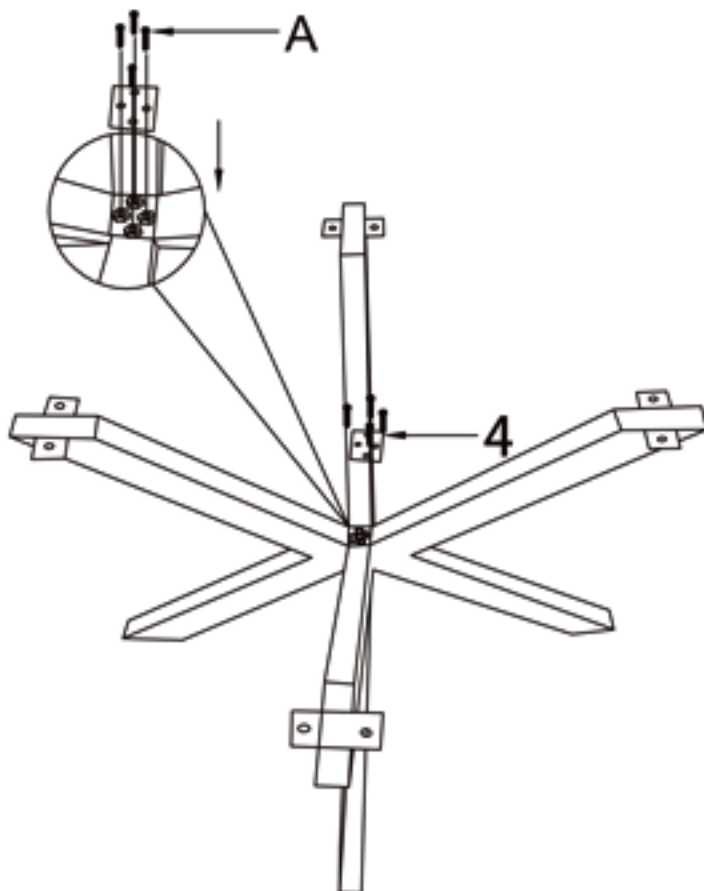
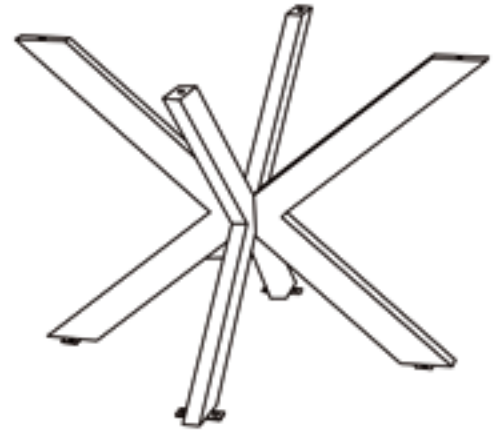
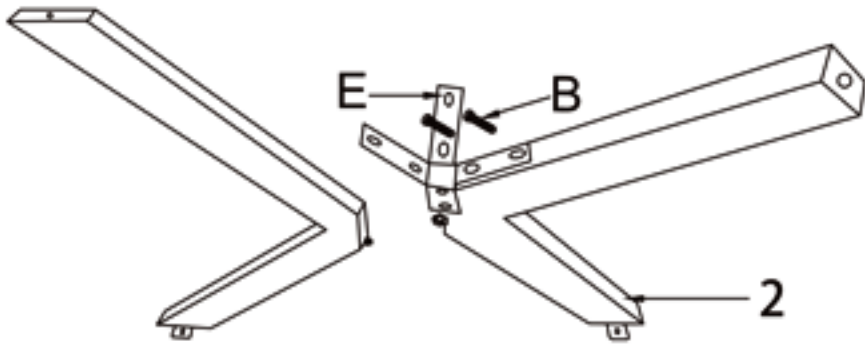

No.	Size	Qty	Ctn no.
1	120X120X3CM	1	1/2
2	100X100X73CM	4	2/2

Hardware Ctn No.	2/2
------------------	-----

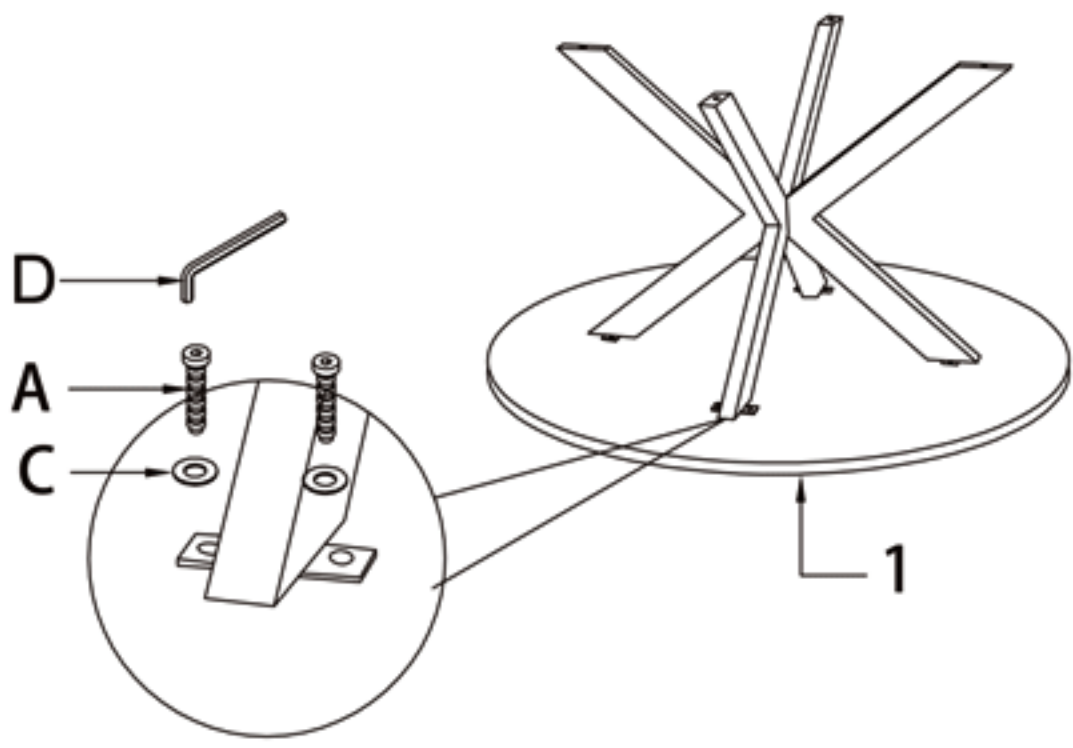
AX12PCS  M8*20mm	B X8PCS  M8*10mm	C X8PCS 	D X1PC 	E X1PC 	F X1PC 
---	---	--	--	---	---





A X8PCS	C X8PCS	D X1PC
		

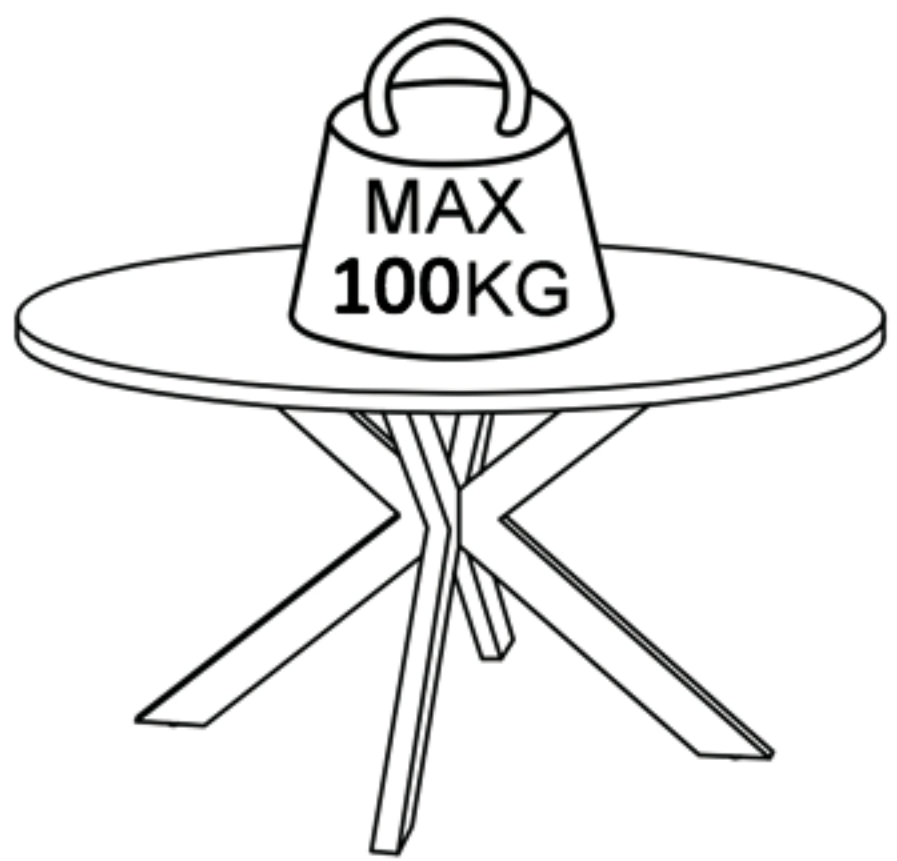

Entretien et maintenance:

Dépeussierer régulièrement avec un chiffon sec.

Nettoyer avec du liquide vaisselle et essuyer avec un chiffon humide.

Ne pas utiliser le produit si l'un des éléments semble endommagé, brisé ou manque.

Eviter de placer ce produit à proximité de feu ouvert et d'autres sources de forte chaleur telle qu'un radiateur.

Care and maintenance:

Remove dust regularly with a dry cloth.

Clean with dishwashing liquid and wipe with a damp cloth.

Do not use the product if any part appears damaged, broken or missing.

Be aware of the risk of open fire and other sources of strong heat, such as electric heaters, in the vicinity of the product.

Cuidado y mantenimiento:

Quite el polvo periódicamente con un paño seco.

Limpiar con líquido para lavar platos y limpie con un paño húmedo.

No utilice el producto si alguna de las piezas está dañada, rota o falta.

Conozca los riesgos de un fuego y de otras fuentes de calor fuerte, como los calefactores eléctricos, en las proximidades del producto.

Pflege und Wartung:

Entfernen Sie den Staub regelmäßig mit einem trockenen Tuch.

Reinigen Sie mit Spülmittel und wischen Sie mit einem feuchten Tuch.

Verwenden Sie das Produkt nicht, wenn Teile beschädigt, defekt sind oder fehlen.

Achten Sie auf die Gefahr von Feuer und anderen starken Wärmequellen in der Nähe des Produkts, wie elektrische Heizkörper.

Cura e manutenzione:

Rimuovere la polvere regolarmente con un panno asciutto.

Pulire con detersivo per piatti e asciugare con un panno umido.

Non utilizzare il prodotto se una parte risulta danneggiata, rotta o mancante.

Essere consapevoli del rischio rappresentato da un camino e da altre fonti di forte calore, come riscaldatori elettrici, in prossimità del prodotto.

Onderhoud en reiniging:

Verwijder regelmatig enigerlei stof met een droge doek.

Reinig met afwasmiddel en veeg af met een vochtig doekje.

Gebruik het product niet als enigerlei onderdelen beschadigd lijken, gebroken zijn of ontbreken.

Houd rekening met de risico's van open vuur en andere krachtige hittebronnen, zoals elektrische verwarmingen, in de buurt van het product.

Cuidado e manutenção:

Remova frequentemente a poeira com um pano seco.

Limpe com detergente da loiça e um pano humedecido.

Não utilize o produto se alguma peça parecer danificada, partida ou em falta.

Tenha em atenção o risco de chama viva e de outras fontes de calor forte, como aquecedores elétricos, perto do produto.



VS-Jul-2017

Imported by - Importé par

CAFOM DISTRIBUTION

9 Rue Jacquart 93310 Le Pré-Saint-Gervais

Made in China/ Fabriqué en Chine