

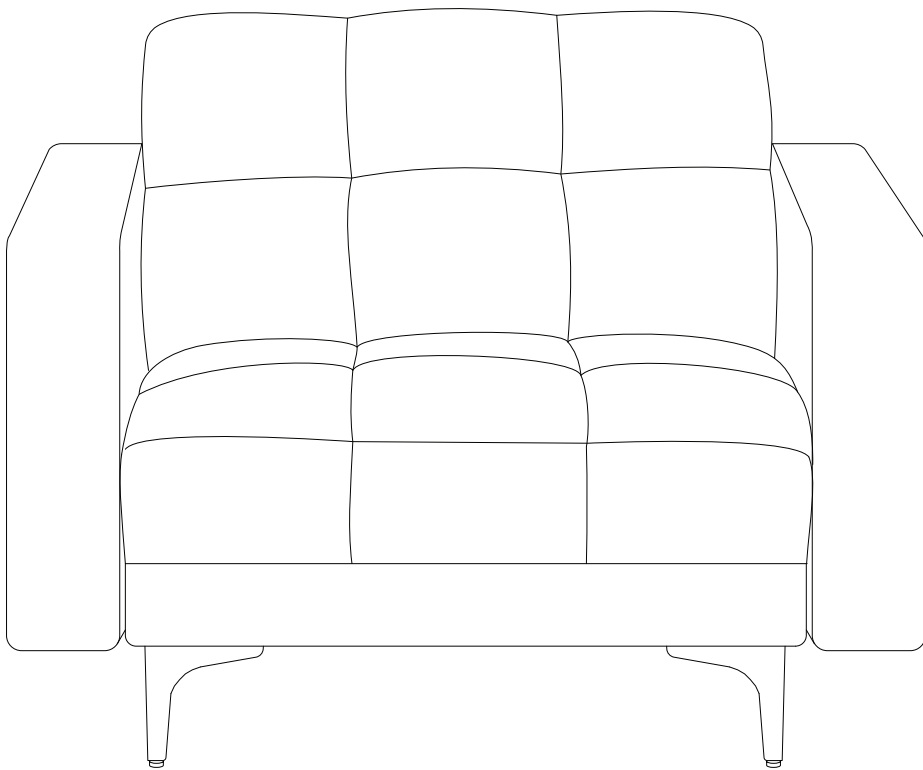

ALNES

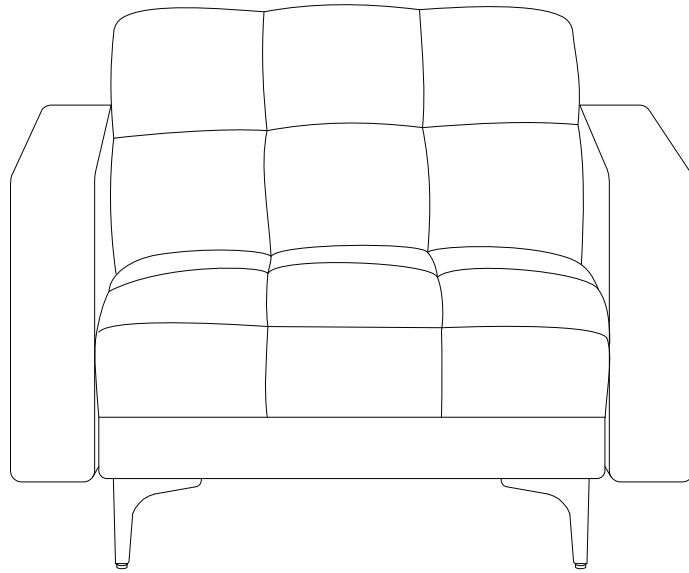

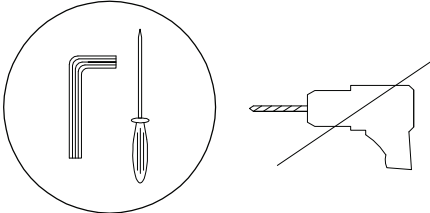

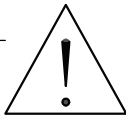
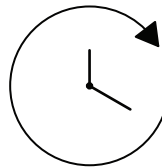
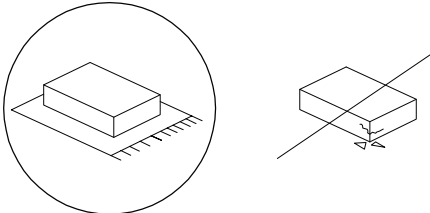
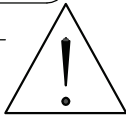

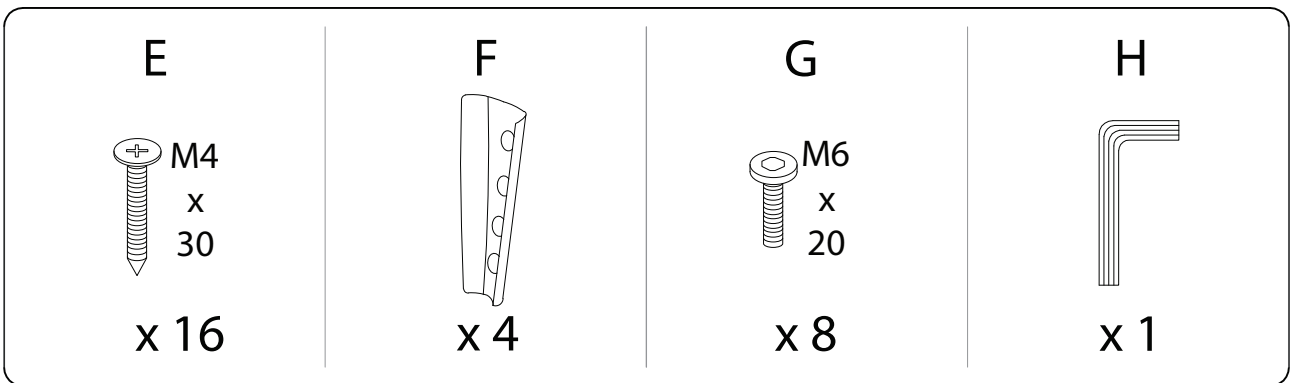
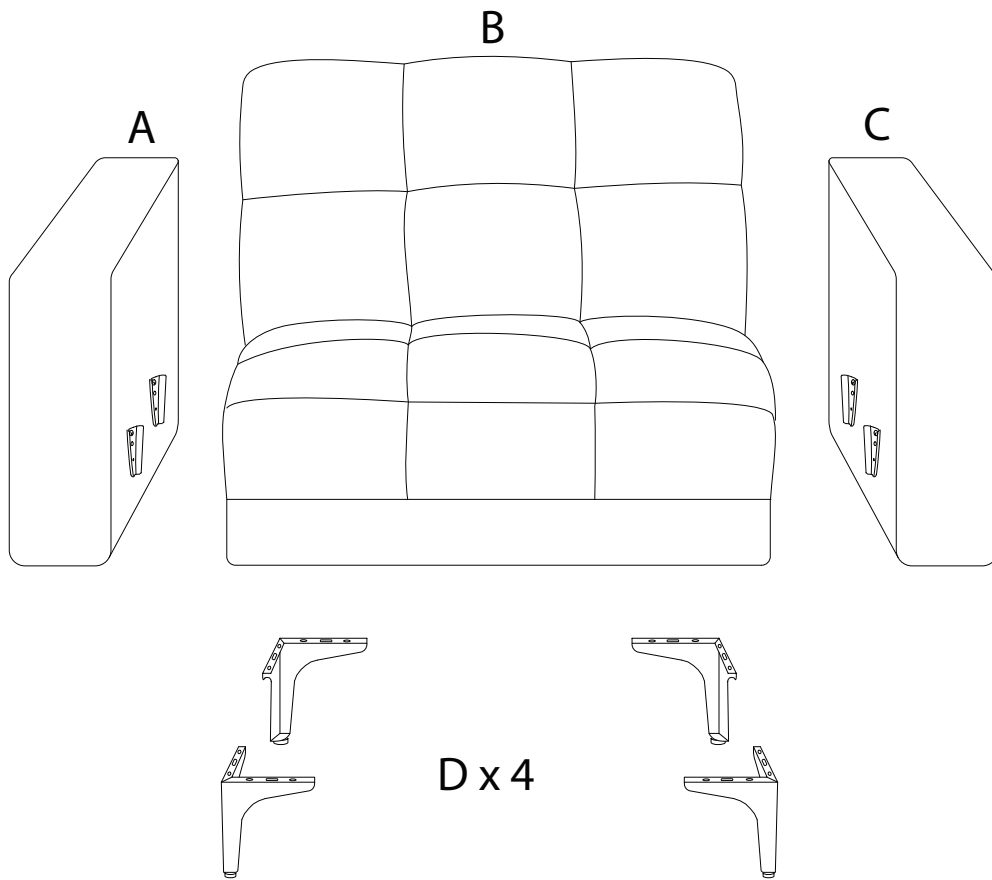
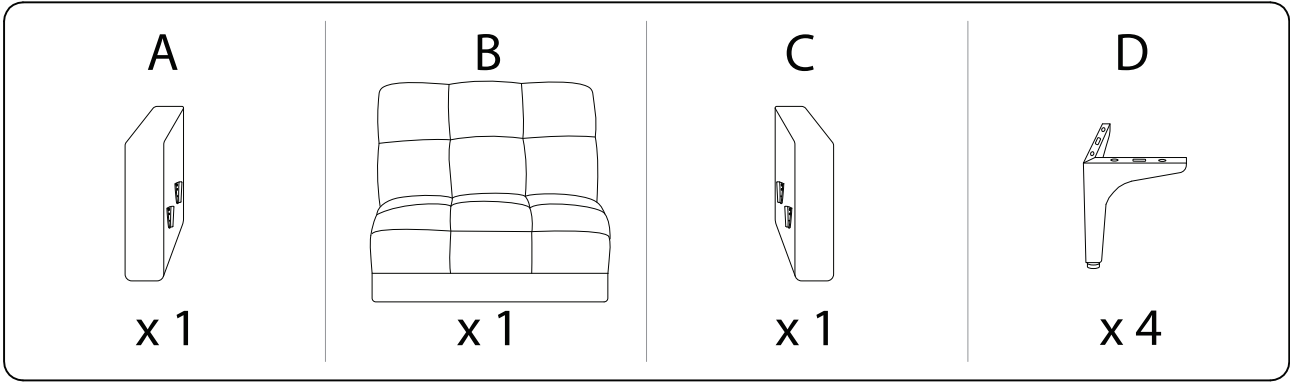
		
		
<p>15'</p>		<p>1</p>

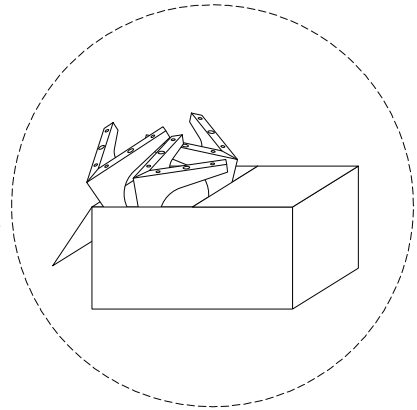
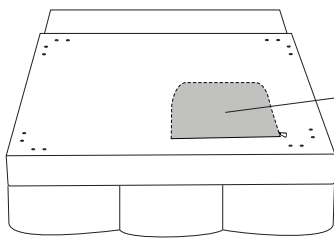
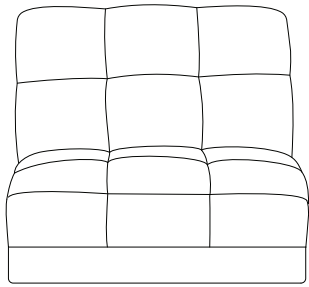

!

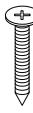

1

<p>B</p>  <p>x 1</p>	<p>D</p>  <p>x 4</p>	<p>E</p>  <p>M4 x 30 x 16</p>
--	--	---

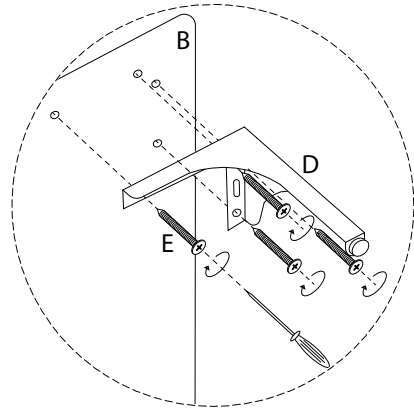
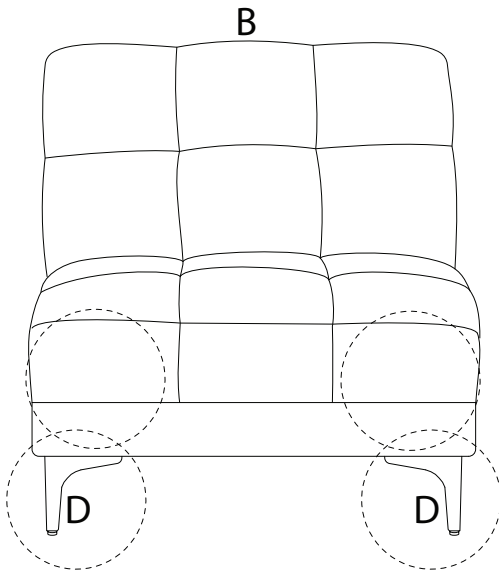

2

F



x 4

G



x 8

H

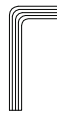

x 1

B

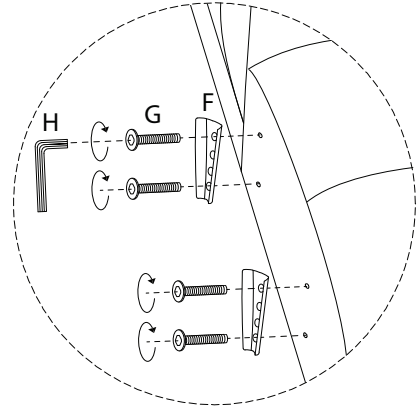
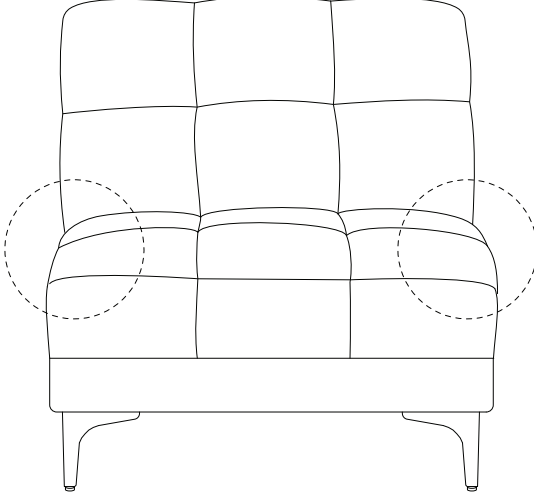

3

A



x 1

C



x 1

B

