

Installation sanleitung Installation Instruction Insturction d'instrallation

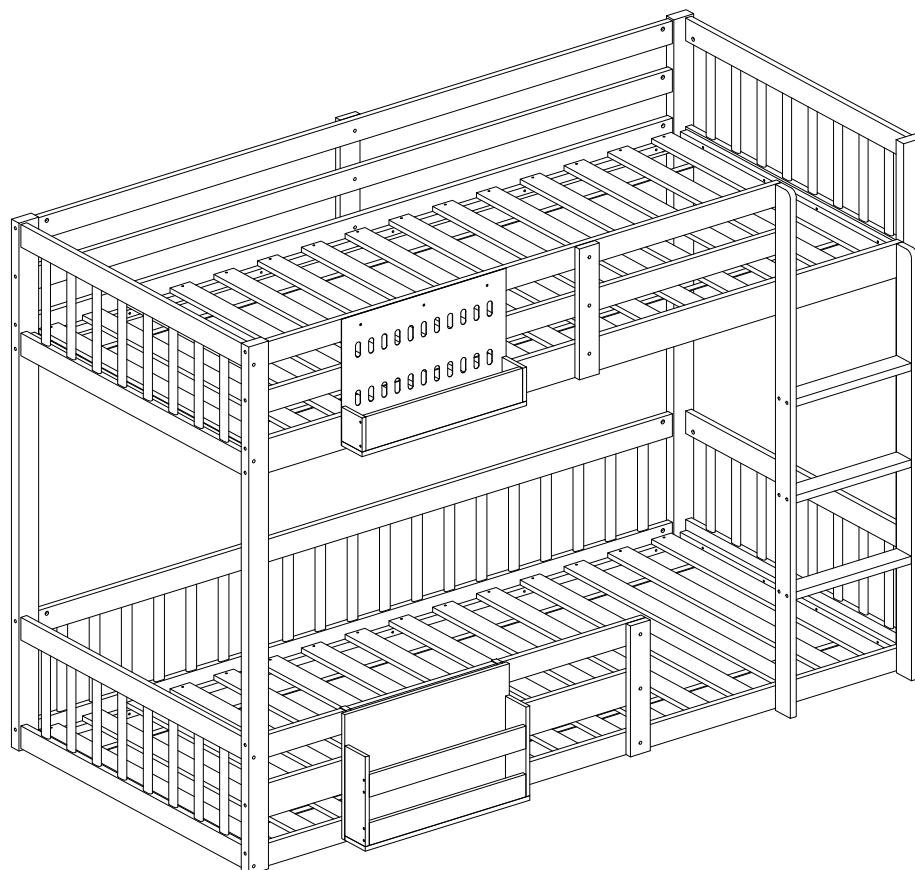

Unser Produkt wird Ihnen in 2 Paketen geliefert. Die Lieferzeiten dieser 2 Pakete können abweichen, bitte haben Sie etwas Geduld und vielen Dank für Ihr Verständnis.

Our product will be delivered to you in 2 packages. The delivery times of these 2 packages may differ, please be patient and thank you for your understanding.

Notre produit vous sera livré en 2 colis. Les délais de livraison de ces 2 colis peuvent différer, soyez patient et merci pour votre compréhension.

N636P446358
N636P446359

ANLEITUNG

WICHTIG - SORGFÄLTIG DURCHLESEN – FÜR ZUKÜNFTIGE REFERENZ BEWAHREN

- a) **WARNUNG** - Hochbetten und das Oberbett von Etagenbetten sind wegen der Verletzungsgefahr durch Stürze nicht für Kinder unter sechs Jahren geeignet.
- b) **WARNUNG** - Etagenbetten und Hochbetten können ein ernstes Verletzungsrisiko darstellen, wenn sie nicht ordnungsgemäß verwendet werden. Befestigen oder hängen Sie niemals Gegenstände an einem Teil des Etagenbetts, die nicht für die Verwendung mit dem Bett vorgesehen sind, zum Beispiel Schnüre, Kordeln, Haken, Gurte und Taschen.
- c) **WARNUNG** - Kinder können zwischen Bett und Wand eingeklemmt werden. Um die Gefahr schwerer Verletzungen zu vermeiden, darf der Abstand zwischen der oberen Sicherheitsbarriere und der angrenzenden Konstruktion 75 mm nicht überschreiten oder mehr als 230 mm betragen.
- d) **WARNUNG** - Verwenden Sie das Etagenbett / Hochbett nicht, wenn ein Bauteil beschädigt ist oder fehlt. Ersatzteile werden zwischendurch beim Hersteller oder beim Händler angefordert.
- e) Befolgen Sie unbedingt die Installationsanweisungen und die Gebrauchsanweisung des Herstellers.
- f) Die empfohlene Größe der Matratze für das Bett beträgt 200 cm x 90 cm, maximale Dicke der Matratze: 12 cm.
- g) Es ist notwendig, den Raum zu lüften, um ein niedriges Feuchtigkeitsniveau aufrechtzuerhalten und das Wachstum von Schimmel im Bett und an dessen Peripherie zu verhindern.
- h) Verbindungselemente sollten immer richtig angezogen und regelmäßig überprüft werden. Bei Bedarf festziehen.
- i) Erfüllt die Anforderungen der europäischen Norm NC-Sicherheit EN 747-1: 2024 & EN 747-2:2024.

INSTRUCTIONS

IMPORTANT - READ CAREFULLY - RETAIN FOR FUTURE REFERENCE

- a) **WARNING** - High beds and the upper bed of bunk beds are not suitable for children under six years due to the risk of injury from falls;
- b) **WARNING** - Bunk beds and high beds can present a serious risk of injury from strangulation if not used correctly. Never attach or hang items to any part of the bunk bed that are not designed to be used with the bed, for example, but not limited to ropes, strings, cords, hooks, belts and bags.
- c) **WARNING** - Children can become trapped between the bed and the wall, a roof pitch, the ceiling adjoining pieces of furniture (e.g. cupboards) and the like. To avoid risk of serious injury the distance between the top safety barrier and the adjoining structure shall not exceed 75 mm or shall be more than 230 mm.
- d) **WARNING** - Do not use the bunk bed/high bed if any structural part is broken or missing; Replacement parts are between requested from the manufacturer or the store.
- e) it is imperative to always follow the installation instructions and manufacturer's use.
- f) The recommended size of the mattress to be used with the bed is 200cm x90cm, maximum thickness mattress:12cm.
- g) It is necessary to ventilate the room in order to maintain a low level moisture and prevent mold growth in the bed and its periphery.
- h) Joining devices should always be tightened properly and regularly verified. Tighten if necessary.
- i) Meets European standard requirements NC safety EN 747-1: 2024 & EN 747-2:2024

INSTRUCTIONS

IMPORTANT - À LIRE ATTENTIVEMENT - CONSERVER POUR RÉFÉRENCE ULTÉRIEURE

- a) **AVERTISSEMENT** - Les lits surélevés et le lit supérieur des lits superposés ne conviennent pas aux enfants de moins de six ans en raison du risque de blessure dû à une chute;
- b) **AVERTISSEMENT** - Les lits superposés et les lits surélevés peuvent présenter un risque sérieux de blessure par strangulation s'ils ne sont pas utilisés correctement. Ne jamais attacher ou suspendre à des parties du lit superposé des objets qui ne sont pas conçus pour être utilisés avec le lit, par exemple, mais ne se limitant pas à des cordes, des ficelles, des cordes, des crochets, des ceintures et des sacs.
- c) **AVERTISSEMENT** - Les enfants peuvent rester coincés entre le lit et le mur, un toit incline les meubles adjacents au plafond (par exemple, des armoires), etc. Pour éviter tout risque de blessure grave, la distance entre la barrière de sécurité supérieure et la structure adjacente ne doit pas dépasser 75 mm ou doit être supérieure à 230 mm.
- d) **AVERTISSEMENT** - N'utilisez pas le lit superposé / le lit surélevé si une partie de la structure est cassée ou manquante. Les pièces de rechange sont demandées au fabricant ou au magasin.
- e) il est impératif de toujours suivre les instructions d'installation et l'utilisation du fabricant.
- f) La taille recommandée du matelas à utiliser avec le lit est 200 cm x 90 cm, épaisseur maximale du matelas: 12 cm.
- g) Il est nécessaire de ventiler la pièce afin de maintenir un faible niveau d'humidité et d'empêcher la formation de moisissure dans le lit et à sa périphérie.
- h) Les dispositifs de jonction doivent toujours être correctement serrés et vérifiés régulièrement. Serrer si nécessaire.
- i) Conforme aux exigences de la norme européenne en matière de sécurité NC EN 747-1: 2024 & EN 747-2:2024 .

ISTRUZIONI

IMPORTANTE - LEGGERE ATTENTAMENTE - CONSERVARE IL FUTURO RIFERIMENTO

- a) **ATTENZIONE** - I letti alti e il letto superiore a castello non sono adatti a bambini di età inferiore ai sei anni a causa del rischio di lesioni da cadute;
- b) **AVVERTENZA** - I letti a castello e i letti alti possono presentare un serio rischio di lesioni a causa di strangolamento se non utilizzati correttamente. Non attaccare o appendere mai oggetti a qualsiasi parte del letto a castello che non sono progettati per essere utilizzati con il letto, ad esempio, ma non limitato a corde, corde, corde, ganci, cinture e borse.
- c) **AVVERTENZA** - I bambini possono rimanere intrappolati tra il letto e la parete, un tetto inclinato il mobile adiacente al soffitto (ad es. armadi) e simili. Per evitare il rischio di gravi lesioni, la distanza tra la barriera di sicurezza superiore a struttura adiacente non deve superare 75 mm o deve essere superiore a 230 mm.
- d) **ATTENZIONE** - Non utilizzare il letto a castello / letto alto se qualche parte strutturale è rotta o mancante; Le parti di ricambio sono tra quelle richieste al produttore o al negozio.
- e) è indispensabile seguire sempre le istruzioni di installazione e l'uso del produttore.
- f) Le dimensioni consigliate del materasso da utilizzare con il letto sono 200 cm x 90 cm, materasso di massimo spessore: 12 cm.
- g) È necessario ventilare l'ambiente per mantenere un'umidità bassa e prevenire la formazione di muffe nel letto e nella sua periferia.
- h) I dispositivi di giunzione devono essere sempre serrati correttamente e regolarmente verificati. Stringere se necessario.
- i) Soddisfa i requisiti della norma europea Sicurezza NCEN 747-1: 2024 & EN 747-2:2024

INSTRUCTIES

BELANGRIJK - LEES AANDACHTIG - BEWAAR VOOR TOEKOMSTIGE REFERENTIE

- a) **WAARSCHUWING** - Hoge bedden en het bovenste bed van stapelbedden zijn niet geschikt voor kinderen jonger dan zes jaar vanwege het risico op letsel door vallen;
- b) **WAARSCHUWING** - Stapelbedden en hoge bedden kunnen een ernstig risico op verwonding vormen als ze niet correct worden gebruikt. Bevestig of hang nooit items aan een deel van het stapelbed die niet zijn ontworpen voor gebruik met het bed, bijvoorbeeld, maar niet beperkt tot touwen, koorden, koorden, haken, riemen en tassen.
- c) **WAARSCHUWING** - Kinderen kunnen vast komen te zitten tussen het bed en de muur, een dakhelling het plafond aangrenzende meubels (bijv. kasten) en dergelijke. Om het risico van ernstig letsel te voorkomen, mag de afstand tussen de bovenste veiligheidsbarrière en de aangrenzende structuur niet groter zijn dan 75 mm of meer dan 230 mm.
- d) **WAARSCHUWING** - Gebruik het stapelbed / hoogbed niet als een structureel onderdeel kapot is of ontbreekt; Vervangende onderdelen worden tussen gevraagd door de fabrikant of de winkel.
- e) het is noodzakelijk om altijd de installatie-instructies en het gebruik van de fabrikant te volgen.
- f) De aanbevolen maat van de matras die met het bed wordt gebruikt, is 200 cm x 90 cm, maximale dikte matras: 12 cm.
- g) Het is noodzakelijk om de kamer te ventileren om een laag vochtgehalte te handhaven en schimmelgroei in het bed en de periferie ervan te voorkomen.
- h) Verbindingsinrichtingen moeten altijd goed worden vastgedraaid en regelmatig worden gecontroleerd. Draai indien nodig vast.
- i) Voldoet aan Europese standaardvereisten NC-veiligheid EN 747-1: 2024 & EN 747-2:2024 .

INSTRUKCE

DŮLEŽITÉ - PŘEČTĚTE SI POZORNĚ - UCHOVÁVAJTE PRO BUDOUCÍ REFERENCIE

- a) **VAROVÁNÍ** - vysoké postele a horní lůžka palandy nejsou vhodné pro děti do šesti let z důvodu rizika zranění pádem;
- b) **VAROVÁNÍ** - Patrové postele a vysoké postele mohou představovat vážné riziko zranění při uškrtní, pokud nebudou správně použity. Nikdy nepřipevňujte ani nezavěšujte předměty na žádnou část palandy, které nejsou navrženy pro použití s postelí, ale neomezují se pouze na lana, provázky, šňůry, háčky, pásy a tašky.
- c) **VÝSTRAHA** - Děti se mohou zachytit mezi postel a zeď, sklonit střechu stropy přilehlé kusy nábytku (např. skříně) a podobně. Aby se zabránilo riziku vážného zranění, nesmí vzdálenost mezi horní bezpečnostní bariérou a sousední konstrukcí překročit 75 mm nebo být větší než 230 mm.
- d) **VÝSTRAHA** - Nepoužívejte patrové lůžko / vysoké lůžko, pokud je některá konstrukční část zlomená nebo chybí; Náhradní díly jsou mezi na vyžádání od výrobce nebo obchodu.
- e) je bezpodmínečně nutné dodržovat instalační pokyny a použití výrobcem.
- f) Doporučená velikost matrace pro použití s postelí je 200 cm x 90 cm, maximální tloušťka matrace: 12 cm.
- g) Místnost je nutné ventilovat, aby se udržela nízká hladina vlhkosti a zabránilo se růstu plísní v loži a jeho obvodu.
- h) Spojovací zařízení by měla být vždy pevně dotažena a pravidelně ověřována. V případě potřeby dotáhněte.
- i) Splňuje požadavky evropské normy NC bezpečnost EN 747-1: 2024 & EN 747-2:2024 .

IINSTRUKCJE

WAŽNE - PRZECZYTAJ UWAGNIE - ZACHOWAJ NA PRZYSZŁOŚĆ

- a) **OSTRZEŻENIE** - Wysokie łózka i górne łózko łózek piętrowych nie są odpowiednie dla dzieci poniżej sześciu lat ze względu na ryzyko obrażeń w wyniku upadku;
- b) **OSTRZEŻENIE** - Łózka piętrowe i wysokie łózka mogą stwarzać poważne ryzyko obrażeń na skutek uduszenia, jeśli nie zostaną właściwie użyte. Nigdy nie mocuj ani nie wieszaj przedmiotów na żadnej części łózka piętrowego, które nie są przeznaczone do użytku z łózkami, na przykład, ale nie ograniczając się do lin, sznurków, sznurków, haczyków, pasów i toreb.
- c) **OSTRZEŻENIE** - Dzieci mogą zostać uwięzione między łózkami a ścianą, nachyleniem dachu pod sufitem przylegającymi meblami (np. szafkami) i tym podobne. Aby uniknąć ryzyka poważnych obrażeń, odległość między górną barierą bezpieczeństwa a przylegającą konstrukcją nie może przekraczać 75 mm lub być większa niż 230 mm.
- d) **OSTRZEŻENIE** - Nie używaj łózka piętrowego / wysokiego łózka, jeśli jakkolwiek część konstrukcyjna jest zepsuta lub brakuje jej; Części zamienne są wymagane od producenta lub sklepu.
- e) bezwzględnie należy przestrzegać instrukcji instalacji i użytkowania producenta.
- f) Zalecany rozmiar materaca do zastosowania z łózkami to 200 cm x 90 cm, maksymalna grubość materaca: 12 cm.
- g) Konieczna jest wentylacja pomieszczenia w celu utrzymania niskiego poziomu wilgoci i zapobiegania rozwojowi pleśni w łózkach i jego obrzeżach.
- h) Urządzenia łączące powinny być zawsze odpowiednio dokręcone i regularnie sprawdzane. Dokręć w razie potrzeby.
- i) Spełnia wymagania norm europejskich Bezpieczeństwo NC EN 747-1: 2024 & EN 747-2:2024 .

INŠTRUKCJE

DÔLEŽITÉ - POZORNE SI PREČÍTAJTE - UCHOVÁVAJTE PRE BUDÚCE REFERENCIE

- a) **VÝSTRAHA** - Vysoké postele a horné postele poschodových postelí nie sú vhodné pre deti do šiestich rokov kvôli riziku zranenia pádom;
- b) **VÝSTRAHA** - poschodové postele a vysoké postele môžu predstavovať vážne riziko zranenia priškrtením, ak sa nebudú správne používať. Nikdy nepřipevňujte ani nevešajte predmety k žiadnej časti poschodovej postele, ktorá nie je určená na použitie s postelou, napríklad, ale nielen, lana, šnúry, šnúry, háčky, pásy a tašky.
- c) **VÝSTRAHA** - Deti sa môžu zachytiť medzi postelou a stenou, sklonom strechy, stropom priliehajúcim kusy nábytku (napr. skrinky) a podobne. Aby sa predišlo riziku vážneho zranenia, vzdialenosť medzi hornou bezpečnostnou bariérou a príľahlou konštrukciou nesmie prekročiť 75 mm alebo byť viac ako 230 mm.
- d) **VÝSTRAHA** - Nepoužívajte poschodovú postel / vysoké lôžko, ak je akákoľvek konštrukčná časť poškodená alebo chýba; Náhradné diely sú potrebné na vyžiadanie od výrobcu alebo skladu.
- e) je bezpodmínečne nutné postupovať podľa pokynov na inštaláciu a podľa pokynov výrobcu.
- f) Odporúčaná veľkosť matrace použitého na lôžko je 200 cm x 90 cm, maximálna hrúbka matrace: 12 cm.
- g) Miestnosť je potrebné vetrať, aby sa udržala nízka úroveň vlhkosti a zabránilo sa rastu plesní v lôžku a jeho obvode.
- h) Spojovacie zariadenia by sa mali vždy pevne dotiahnuť a pravidelne preverovať. V prípade potreby dotiahnite.
- i) Splňa požiadavky európskych noriem NC bezpečnosť EN 747-1: 2024 & EN 747-2:2024 .

UTASÍTÁS

FONTOS - OLVASSA EL FIGYELMESEN - VÁRJON A JÖVŐBEN

- a) **VIGYÁZAT** - A magas ágyak és az emeletes ágyak felső ágya nem alkalmas hat év alatti gyermekek számára az esések sérülésének veszélye miatt;
- b) **FIGYELMEZTETÉS** - Az emeletes ágyak és a magas ágyak súlyos sérülést okozhatnak a fojtogatás következtében, ha nem használják helyesen. Soha ne csatlakoztasson és ne lógjon az emeletes ágy olyan részeire, amelyeket például nem az ágyhoz való felhasználásra terveztek, de ezekre nem korlátozódik: kötelek, húrok, zsinórok, horgok, övek és táskák.
- c) **FIGYELMEZTETÉS** - A gyermekek becsapódhatnak az ágy és a fal közé, tetőtéri a mennyezetet a szomszédos bútorokhoz (például szekrényekhez) és hasonlókat. A súlyos sérülés kockázatának elkerülése érdekében a felső biztonsági akadály és a szomszédos szerkezet közötti távolság nem haladhatja meg a 75 mm-t vagy több, mint 230 mm.
- d) **FIGYELMEZTETÉS** - Ne használja az emeletes ágyat / magas ágyat, ha valamelyik szerkezeti elem törött vagy hiányzik; A cserealkatrészeket a gyártótól vagy a bolttól kérheti.
- e) feltétlenül kövesse a telepítési utasításokat és a gyártó általi felhasználást.
- f) Az ágyhoz használni kívánt matrac ajánlott mérete 200 cm x 90 cm, a matrac maximális vastagsága: 12 cm.
- g) Szellőztetni kell a helyiséget, hogy fennmaradjon az alacsony nedvességtartalom, és megakadályozzák a penész növekedését az ágyban és annak peremén.
- h) A csatlakozóberendezéseket mindig megfelelően meg kell húzni és rendszeresen ellenőrizni kell. Szükség esetén húzza meg.
- i) Megfelel az európai szabvány követelményeinek NC biztonsági EN 747-1: 2024 & EN 747-2:2024.

INSTRUCȚIUNI

IMPORTANT - CITIȚI CU ATENȚIE - PĂȚIȚI PENTRU REFERINȚĂ VIITORĂ

- a) **AVERTIZARE** - Paturile înalte și patul superior al paturilor nu sunt potrivite pentru copiii sub șase ani din cauza riscului de rănire din cauza căderilor;
- b) **AVERTIZARE** - Paturile suprapuse și paturile înalte pot prezenta un risc grav de rănire din cauza strangulării dacă nu sunt utilizate corect. Nu atașați și nu agățați niciodată articole pe nicio parte a patului care nu sunt concepute pentru a fi utilizate cu patul, de exemplu, dar fără a se limita la frânghii, corzi, șnururi, cârlige, curele și saci.
- c) **AVERTIZARE** - Copiii pot deveni prinși între pat și perete, pot acoperi acoperișul pe piesele de mobilier alăturate (de ex. dulapuri) și altele asemenea. Pentru a evita riscul de rănire gravă, distanța dintre bariera de siguranță superioară și structura alăturată nu trebuie să depășească 75 mm sau să fie mai mare de 230 mm.
- d) **AVERTIZARE** - Nu folosiți patul supraetajat / patul înalt dacă o parte structurală este ruptă sau lipsește; Piesele de schimb se fac între solicitarea producătorului sau a magazinului.
- e) este obligatoriu să respectați întotdeauna instrucțiunile de instalare și utilizarea producătorului.
- f) Dimensiunea recomandată a saltelei care va fi folosită cu patul este de 200cm x90cm, grosimea maximă a saltelei:12 cm.
- g) Este necesară ventilarea camerei pentru a menține o umiditate la nivel scăzut și a preveni creșterea mucegaiului în pat și la periferia acesteia.
- h) Dispozitivele de îmbinare trebuie întinse întotdeauna corect și verificate regulat. Strângeți dacă este necesar.
- i) Îndeplinește cerințele standardelor europene privind siguranța NC EN 747 -1: 2024 & EN 747-2:2024.

TALİMATLAR

ÖNEMLİ - DİKKATLE OKUYUN - GELECEK REFERANS İÇİN TUTUN

- a) **UYARI** - Yüksek yataklar ve ranzaların üst yatağı, düşme nedeniyle yaralanma tehlikesi nedeniyle altı yaşın altındaki çocuklar için uygun değildir;
- b) **UYARI** - Ranzalar ve yüksek yataklar, doğru kullanılmadığı takdirde boğulma nedeniyle ciddi yaralanma riski oluşturabilir. Hiçbir zaman ranza yatağının, yatakla birlikte kullanılmak üzere tasarlanmamış, ancak ipler, kordonlar, kancalar, kayışlar ve çantalar ile sınırlı olmamak üzere herhangi bir parçasına takmayın veya asılmayın.
- c) **UYARI** - Çocuklar yatakla duvar arasında sıkışıp kalabilir, tavana bitişik mobilya parçaları (örneğin dolaplar) ve benzeri bir tavan döşenir. Ciddi yaralanma riskini önlemek için üst güvenlik bariyeri ve bitişik yapı arasındaki mesafe 75 mm'yi geçmemelidir veya 230 mm'den fazla olmalıdır.
- d) **UYARI** - Herhangi bir yapısal parça kırılmış veya eksikse ranza / yüksek yatak kullanmayın; Yedek parçalar üretici veya mağazadan talep arasındadır.
- e) her zaman kurulum talimatlarını ve üreticinin kullanımını takip etmek zorunludur.
- f) Yatak ile birlikte kullanılması tavsiye edilen yatak boyutu 200 cm x 90 cm, maksimum kalınlık yatağı: 12 cm'dir.
- g) Düşük seviyede nem sağlamak ve yatak ve çevresinde küf oluşumunu önlemek için odanın havalandırılması gerekir.
- h) Birleştirme cihazları her zaman uygun şekilde sıkılmalı ve düzenli olarak kontrol edilmelidir. Gerekirse sıkın.
- i) EN 747-1: 2024 & EN 747-2:2024 Avrupa standardı gerekliliklerini karşılar.

ИНСТРУКЦИИ

ВАЖНО - ПРОЧИТАЙТЕ ВНИМАТЕЛЬНО - СОХРАНИТЕ БУДУЩУЮ ССЫЛКУ

- a) **ПРЕДУПРЕЖДЕНИЕ** - Высокие кровати и верхняя кровать двухъярусных кроватей не подходят для детей младше шести лет из-за риска получения травмы в результате падения;
- b) **ПРЕДУПРЕЖДЕНИЕ** - двухъярусные кровати и высокие кровати могут представлять серьезную опасность травмирования от удушья, если их неправильно использовать. Никогда не прикрепляйте и не подвешивайте предметы к какой-либо части двухъярусной кровати, например, которые не предназначены для использования с кроватью, но не ограничиваются веревками, веревками, шнурами, крючками, ремнями и сумками.
- c) **ПРЕДУПРЕЖДЕНИЕ** - Дети могут оказаться в ловушке между кроватью и стеной, крышей, наклонить потолок к смежным предметам мебели (например, шкафам) и т.п. Во избежание риска получения серьезных травм расстояние между верхним защитным барьером и прилегающей конструкцией не должно превышать 75 мм или должно быть более 230 мм.
- d) **ПРЕДУПРЕЖДЕНИЕ** - не используйте двухъярусную кровать / высокую кровать, если какая-либо конструктивная часть сломана или отсутствует; Запасные части между запросами от производителя или магазина.
- e) обязательно всегда следовать инструкциям по установке и использованию изготовителем.
- f) Рекомендуемый размер матраса, который будет использоваться с кроватью, составляет 200 см x 90 см, максимальная толщина матраса: 12 см.
- g) Необходимо проветривать помещение, чтобы поддерживать низкий уровень влаги и предотвращать образование плесени в ложе и на его периферии.
- h) Соединительные устройства всегда должны быть надежно затянуты и регулярно проверяться. Затянуть при необходимости.
- i) Соответствует требованиям Европейского стандарта NC Safety EN 747-1: 2024 & EN 747-2:2024.

English

IMPORTANT ! KEEP FOR FUTURE REFERENCE : READ CAREFULLY

- To be assembled by an adult. Assembly must be checked by an adult before use
 - WARNING ! Keep all screws, small parts and plastic bags out of the reach of children
 - Properly identify all parts before assembling
 - Never use your item if any of its parts are broken or missing
 - Should any problems arise, please contact our After Sales Service
 - Manufacturer's instructions shall be followed at all times
 - Care: Clean with a soft, dry cloth. In case of larger stains, carefully rub with a slightly damp, non-abrasive sponge
 - Avoid the risk of fire by not placing furniture near sources of ignition or hot items
- Do not jump on the bed

Deutsch

WICHTIG ! ZUM SPÄTEREN NACHSCHLAGEN AUFBEWAHREN: SORGFÄLTIG LESEN

- Muss von einem Erwachsenen zusammengebaut werden. Der Zusammenbau muss vor dem Gebrauch von einem Erwachsenen überprüft werden
 - WARNUNG! Bewahren Sie alle Schrauben, Kleinteile und Plastikbeutel außerhalb der Reichweite von Kindern auf
 - Kennzeichnen Sie vor dem Zusammenbau alle Teile richtig
 - Benutzen Sie Ihren Artikel niemals, wenn Teile gebrochen sind oder fehlen
 - Sollten Probleme auftreten, wenden Sie sich bitte an unseren Kundendienst
 - Die Anweisungen des Herstellers sind stets zu befolgen
 - Pflege: Mit einem weichen, trockenen Tuch reinigen. Bei größeren Flecken vorsichtig mit einem leicht feuchten, nicht scheuernden Schwamm abreiben. nicht scheuernden Schwamm
 - Vermeiden Sie die Gefahr eines Brandes, indem Sie die Möbel nicht in der Nähe von Zündquellen oder heißen Gegenständen aufstellen
- Nicht auf das Bett springen

Français

IMPORTANT ! CONSERVER POUR RÉFÉRENCE ULTÉRIEURE : LIRE ATTENTIVEMENT

- Le montage doit être effectué par un adulte. Le montage doit être vérifié par un adulte avant Utilisation
 - ATTENTION ! Tenir les vis, les petites pièces et les sachets en plastique hors de portée des enfants
 - Identifiez correctement toutes les pièces avant de les assembler
 - N'utilisez jamais votre article si l'une de ses pièces est cassée ou manquante
 - En cas de problème, veuillez contacter notre service après-vente
 - Les instructions du fabricant doivent être respectées à tout moment
 - Entretien : nettoyer avec un chiffon doux et sec. En cas de taches plus importantes, frotter soigneusement avec une éponge non abrasive légèrement humide. légèrement humide et non Abrasive
 - Évitez les risques d'incendie en ne plaçant pas les meubles à proximité de sources d'inflammation ou d'objets chauds
- Ne pas sauter sur le lit

Italiano

IMPORTANTE! CONSERVARE PER RIFERIMENTO FUTURO: LEGGERE ATTENTAMENTE

- Deve essere assemblato da un adulto. L'assemblaggio deve essere controllato da un adulto prima dell'uso
- **ATTENZIONE!** Tenere tutte le viti, le piccole parti e i sacchetti di plastica fuori dalla portata dei bambini
- Identificare correttamente tutte le parti prima dell'assemblaggio
- Non utilizzare mai l'articolo se alcune parti sono rotte o mancanti
- In caso di problemi, si prega di contattare il nostro Servizio Post Vendita
- Le istruzioni del produttore devono essere sempre seguite
- Cura: Pulire con un panno morbido e asciutto. In caso di macchie più estese, strofinare accuratamente con una spugna leggermente umida e nonspugna leggermente umida e non abrasiva
- Evitare il rischio di incendio, non collocando i mobili vicino a fonti di accensione o a oggetti caldi
- Non saltare sul letto

Español

¡ IMPORTANTE ! CONSERVELO PARA FUTURAS CONSULTAS: LEA ATENTAMENTE

- Debe ser montado por un adulto. El montaje debe ser comprobado por un adulto antes del uso
- ADVERTENCIA** Mantenga todos los tornillos, piezas pequeñas y bolsas de plástico fuera del alcance de los niños.
- Identifique correctamente todas las piezas antes de montarlas
 - Nunca utilice su artículo si alguna de sus piezas está rota o falta
 - Si surge algún problema, póngase en contacto con nuestro Servicio Postventa
 - Las instrucciones del fabricante deben seguirse en todo momento
 - Cuidado: Limpiar con un paño suave y seco. En caso de manchas más grandes, frote cuidadosamente con una esponja no abrasiva ligeramente humedecida.
 - Evite el riesgo de incendio no colocando los muebles cerca de fuentes de ignición u objetos calientes.
 - No saltar sobre la cama.

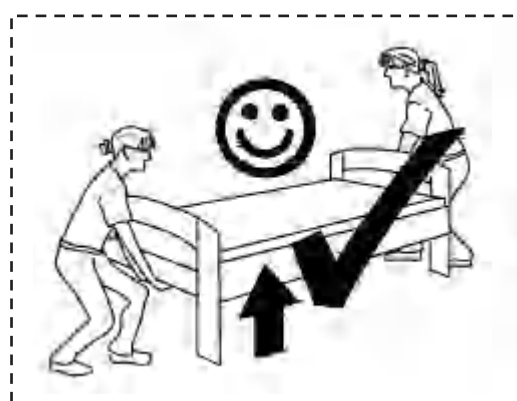
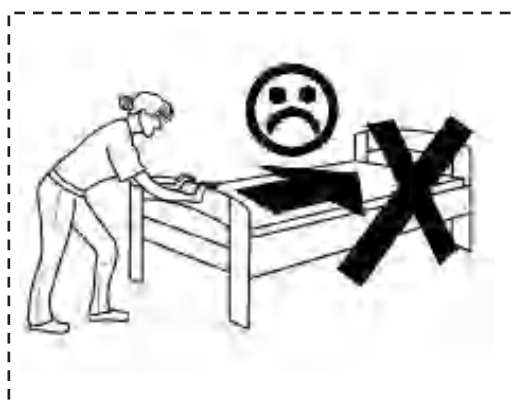



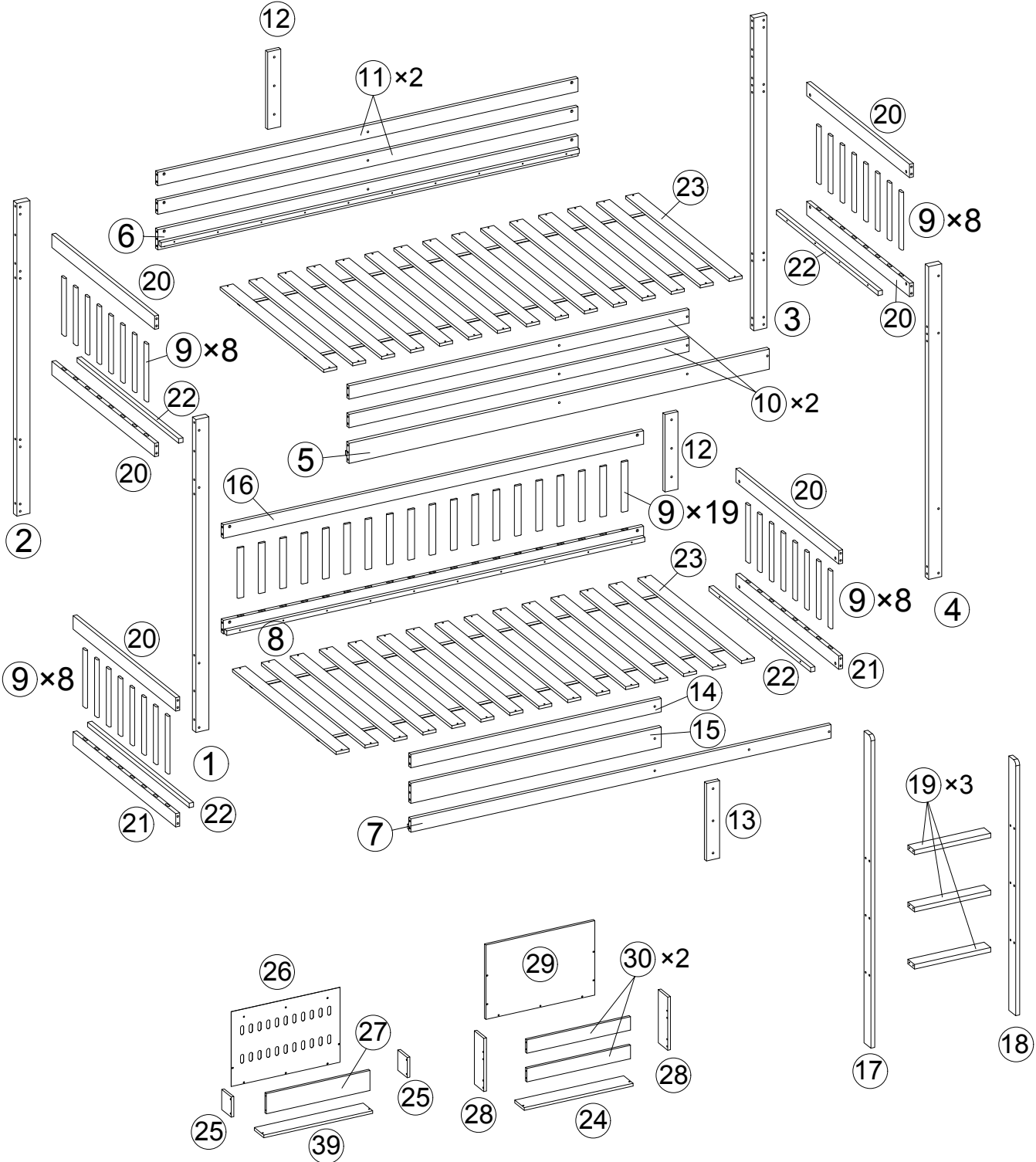





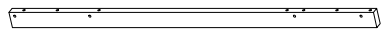

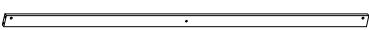



MONTAGEANLEITUNG/ASSEMBLY INSTRUCTIONS

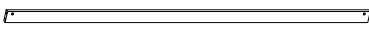



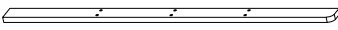







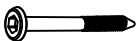
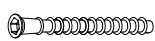

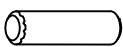

MONTAGEANLEITUNG/ASSEMBLY INSTRUCTIONS

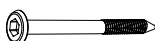
N636P446358

1		1PC	10		2PCS
2		1PC	11		2PCS
3		1PC	14		1PC
4		1PC	15		1PC
5		1PC	16		1PC
6		1PC	17		1PC
7		1PC	18		1PC
8		1PC	22		4PCS
Hardware box		1PC			











MONTAGEANLEITUNG/ASSEMBLY INSTRUCTIONS

N636P446358 — Hardware box

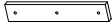
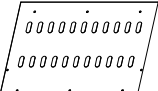
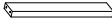
A	6x70		16PCS	I	7x60		18PCS
B	4x30		76PCS	J	3x12		9PCS
C	8x30		35PCS	K			2PCS
D			38PCS	L	M3		1PC
E	6x110		22PCS	M	M4		2PCS
F	6x25		9PCS	N			1PC
G	6x20		9PCS	O			2PCS
H	5x40		23PCS	P	3x16		5PCS

MONTAGEANLEITUNG/ASSEMBLY INSTRUCTIONS

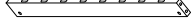
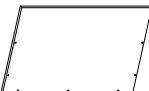
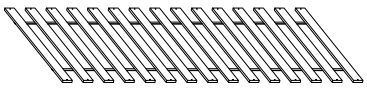
N636P446359

9		51PCS	24		1PC
12		2PCS	25		2PCS
13		1PC	26		1PC
19		3PCS	27		1PC
20		6PCS	28		2PCS
21		2PCS	29		1PC
23		2PCS	30		2PCS
			39		1PC

MONTAGEANLEITUNG/ASSEMBLY INSTRUCTIONS

E

22PCS

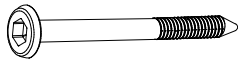

M6x110

A

16PCS



M6x70

Bitte beachten Sie, dass die Formen der Schrauben E und A ähnlich sind. Bitte installieren Sie entsprechend der Anleitung und unterscheiden Sie sie!

Please note that the shapes of screws E and A are similar.

Please install according to the instructions and distinguish them!

Notez que les vis E et A ont des formes similaires. Veuillez les installer en suivant les instructions pour les séparer!

J

9PCS

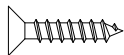

M3x12

B

76PCS

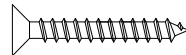

M4x30

Bitte beachten Sie, dass die Formen der Schrauben J und B ähnlich sind. Bitte installieren Sie entsprechend der Anleitung und unterscheiden Sie sie!

Please note that the shapes of screws J and B are similar.

Please install according to the instructions and distinguish them!

Notez que les vis J et B ont des formes similaires. Veuillez les installer en suivant les instructions pour les séparer!

MONTAGEANLEITUNG/ASSEMBLY INSTRUCTIONS

H **23PCS**

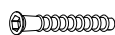

ø5x40

I **18PCS**

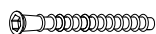

ø7x60

Bitte beachten Sie, dass die Formen der Schrauben H und I ähnlich sind. Bitte installieren Sie entsprechend der Anleitung und unterscheiden Sie sie!

Please note that the shapes of screws H and I are similar.

Please install according to the instructions and distinguish them!

Notez que les vis H et I ont des formes similaires. Veuillez les installer en suivant les instructions pour les séparer!

Vor dem Einbau die Schrauben in die Löcher stecken und festziehen, aber nicht bis 100%, 70% bis 80% anziehen reicht aus. Schließlich, nachdem alle Schrauben installiert sind, ziehen Sie alle Schrauben auf 100%.

Wenn Sie auf diese Probleme stoßen, wie z. B. Fehlausrichtung der Löcher oder Unfähigkeit, bestimmte Teile zu installieren, überprüfen Sie bitte, ob die Schrauben korrekt verwendet werden und passen Sie die Dichtigkeit der Schrauben an.

Before installation, insert the screws into the holes and tighten them, but do not tighten them to 100%, 70% to 80% is sufficient. Finally, after all screws are installed, tighten all screws to 100%. If you encounter these issues, such as if the holes cannot be aligned or some parts cannot be installed, please check if the screws are used correctly and adjust the tightness of the screws.

Insérer la vis dans le trou avant la fin de l'assemblage, serrer la vis, mais ne pas serrer à 100%, 70% ~ 80% est correct. Enfin, une fois que toutes les vis sont bien serrées, toutes les vis sont serrées à 100%.

Si vous rencontrez ces problèmes, par exemple si les trous ne sont pas alignés ou si certaines pièces ne peuvent pas être montées, vérifiez que les vis sont utilisées correctement et Ajustez leur serrage.

MONTAGEANLEITUNG/ASSEMBLY INSTRUCTIONS

1

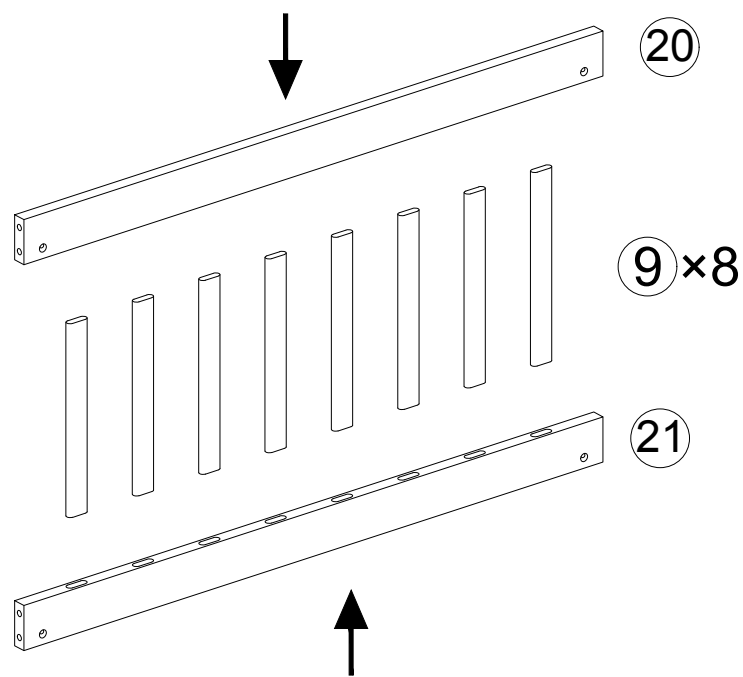
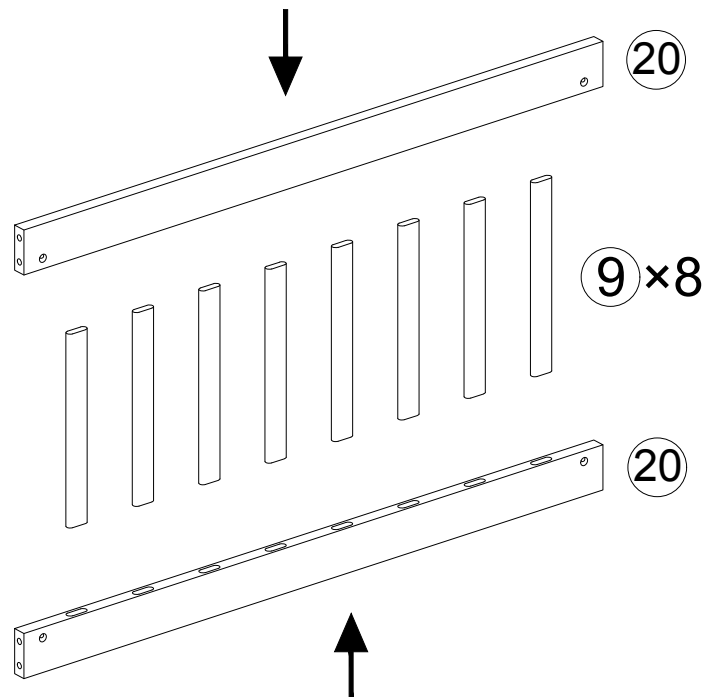

x2

MONTAGEANLEITUNG/ASSEMBLY INSTRUCTIONS

2

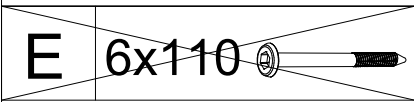
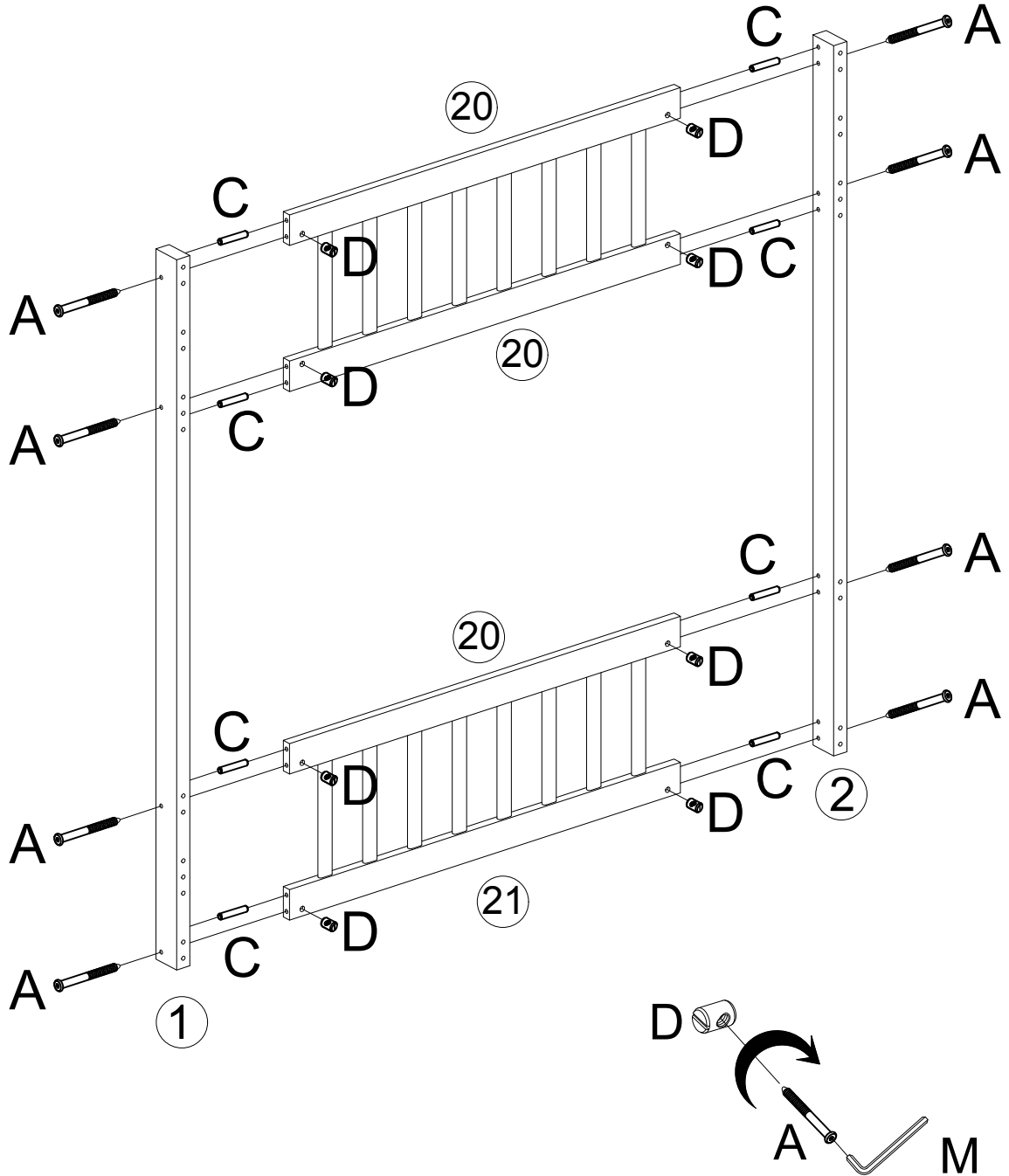



A	6x70		8PCS	D		8PCS
C	8x30		8PCS	M	M4	1PC

MONTAGEANLEITUNG/ASSEMBLY INSTRUCTIONS

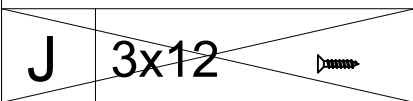
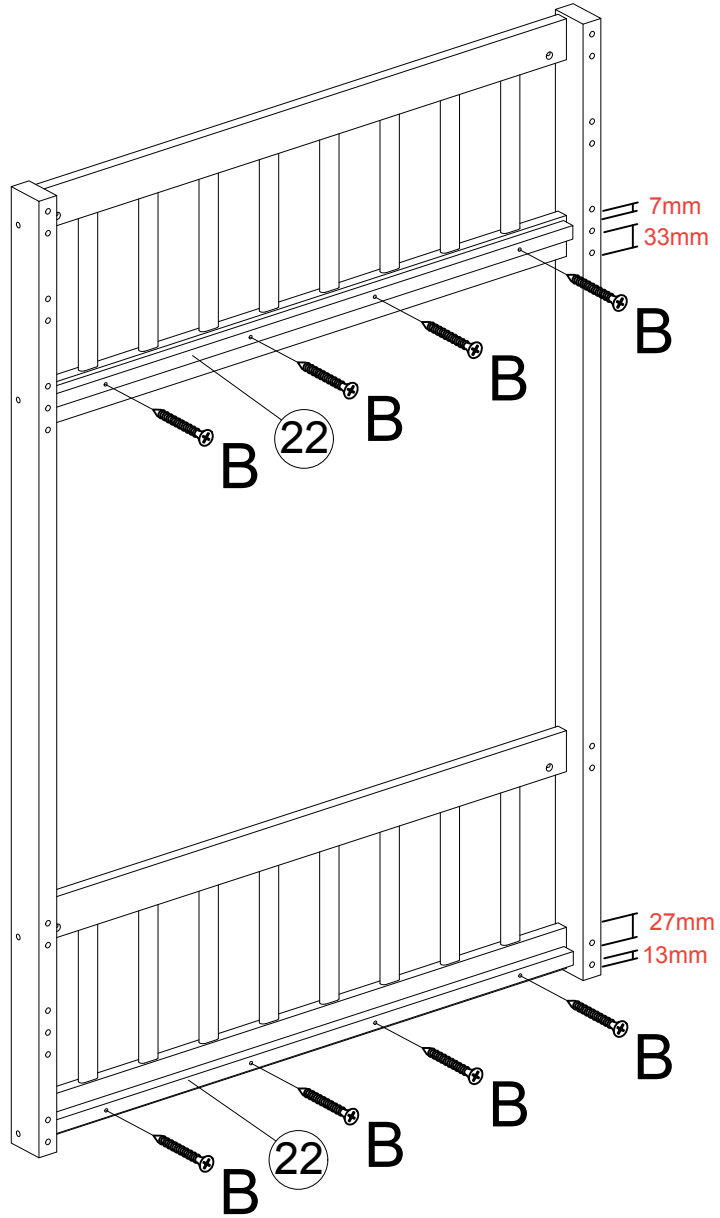
3



B	4x30		8PCS	N		1PC
---	------	---	------	---	--	-----

MONTAGEANLEITUNG/ASSEMBLY INSTRUCTIONS

4

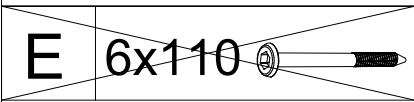
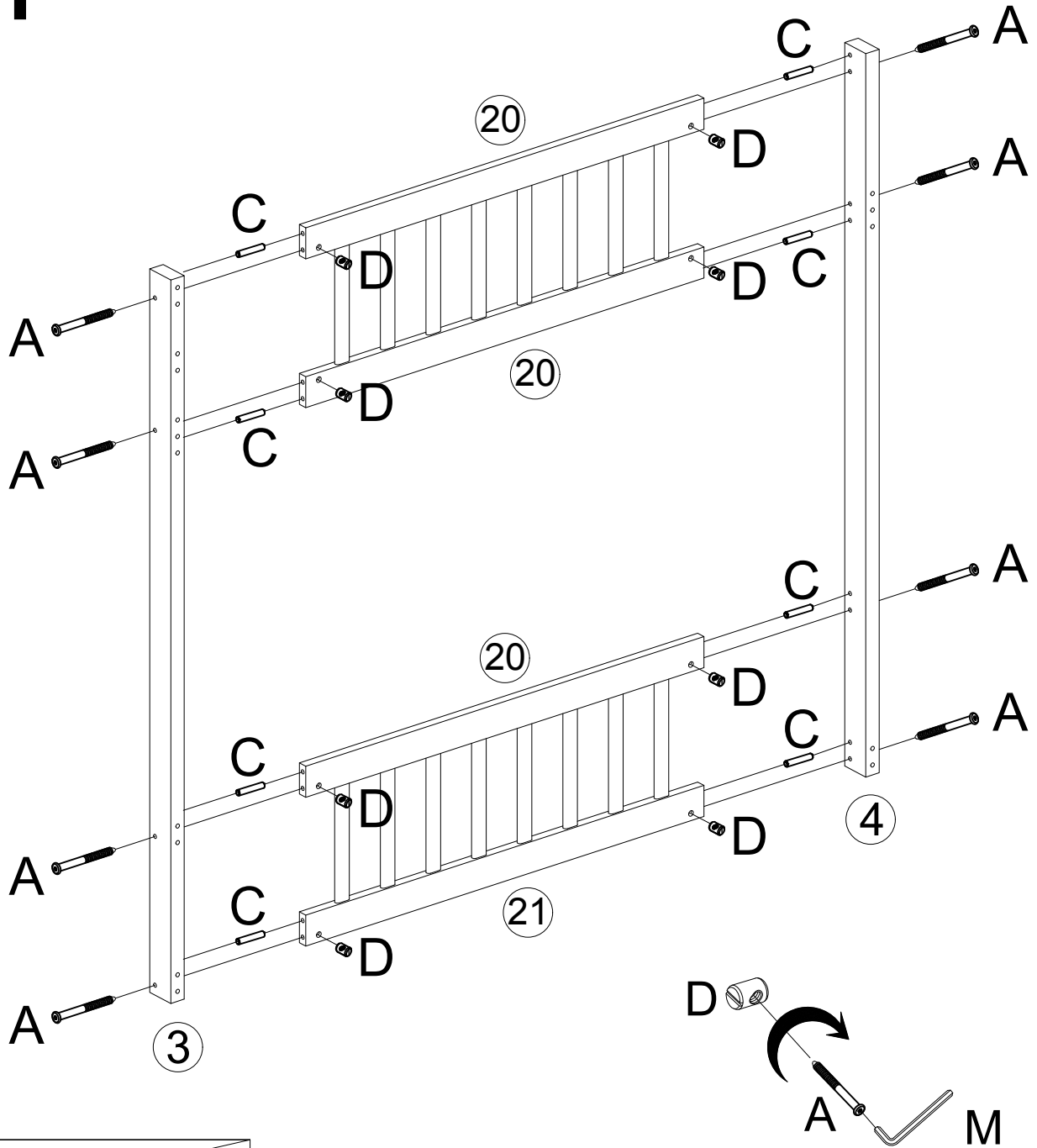



A	6x70		8PCS	D		8PCS
C	8x30		8PCS	M	M4	1PC

MONTAGEANLEITUNG/ASSEMBLY INSTRUCTIONS

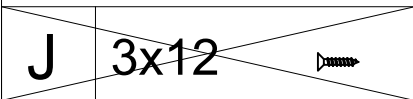
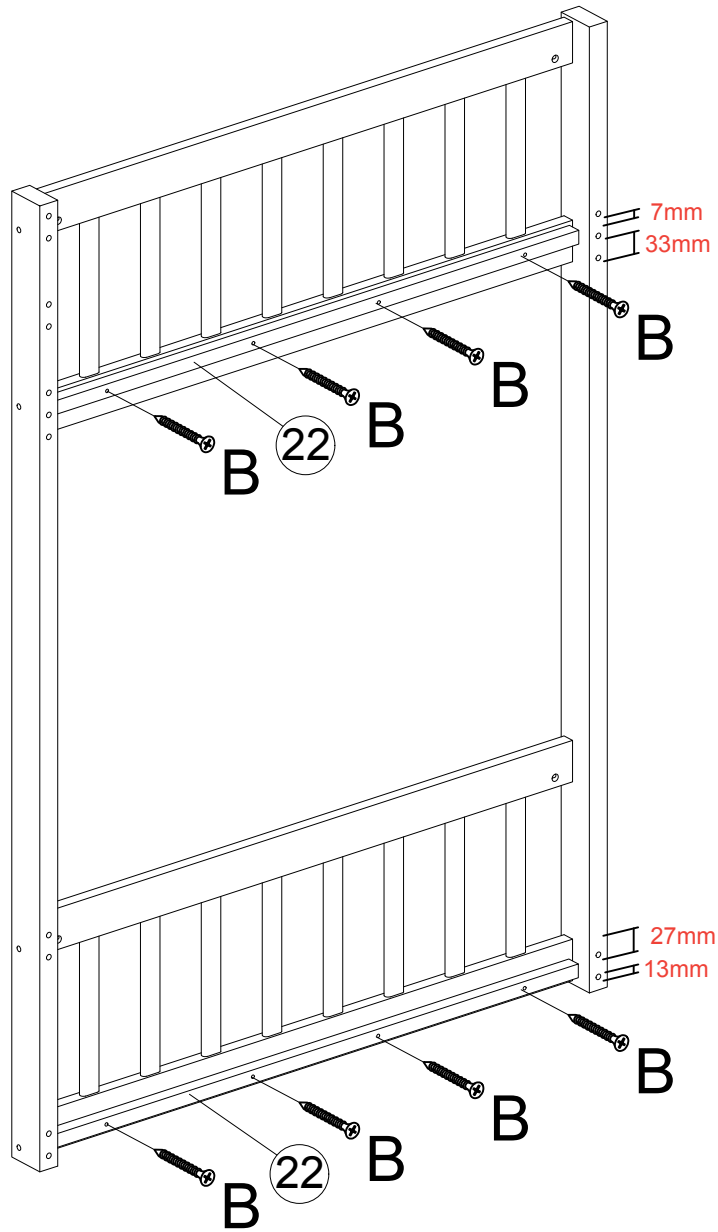
5



B	4x30		8PCS	N		1PC
---	------	---	------	---	--	-----

MONTAGEANLEITUNG/ASSEMBLY INSTRUCTIONS

6

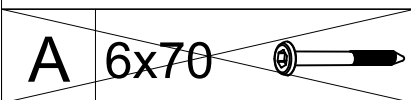
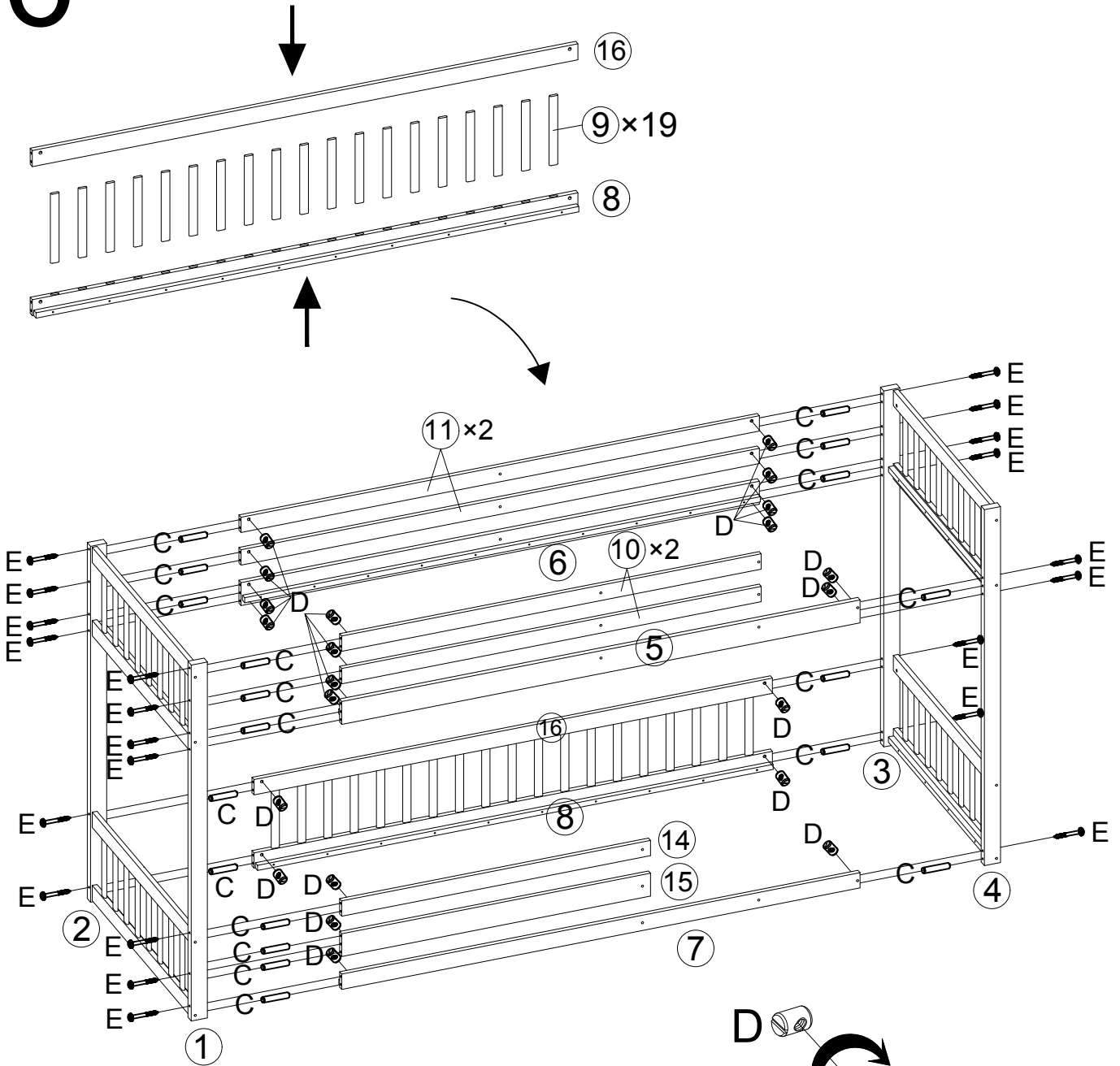



E	6x110		22PCS	D		22PCS	
C	8x30		19PCS	M	M4		1PC

MONTAGEANLEITUNG/ASSEMBLY INSTRUCTIONS

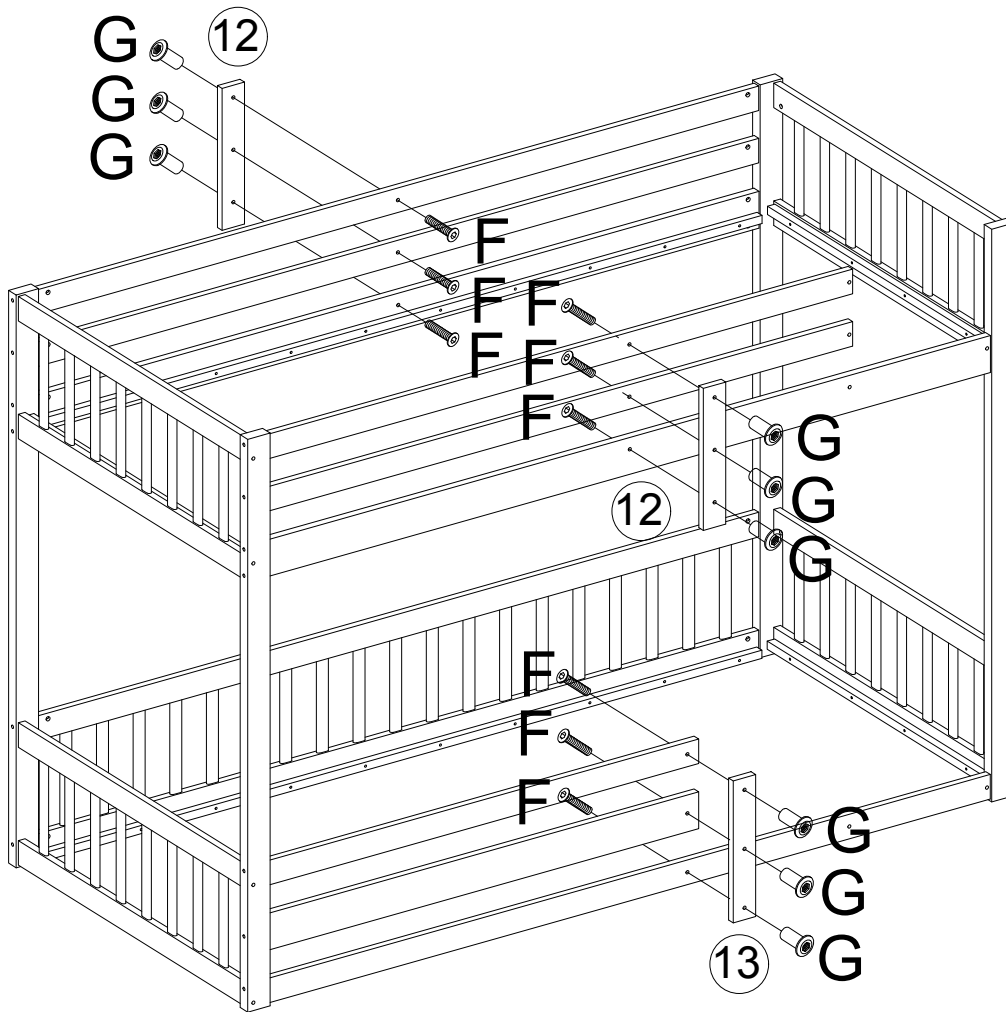
7





F	6x25		9PCS			
G	6x20		9PCS	M	M4	 2PCS

MONTAGEANLEITUNG/ASSEMBLY INSTRUCTIONS

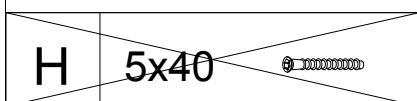
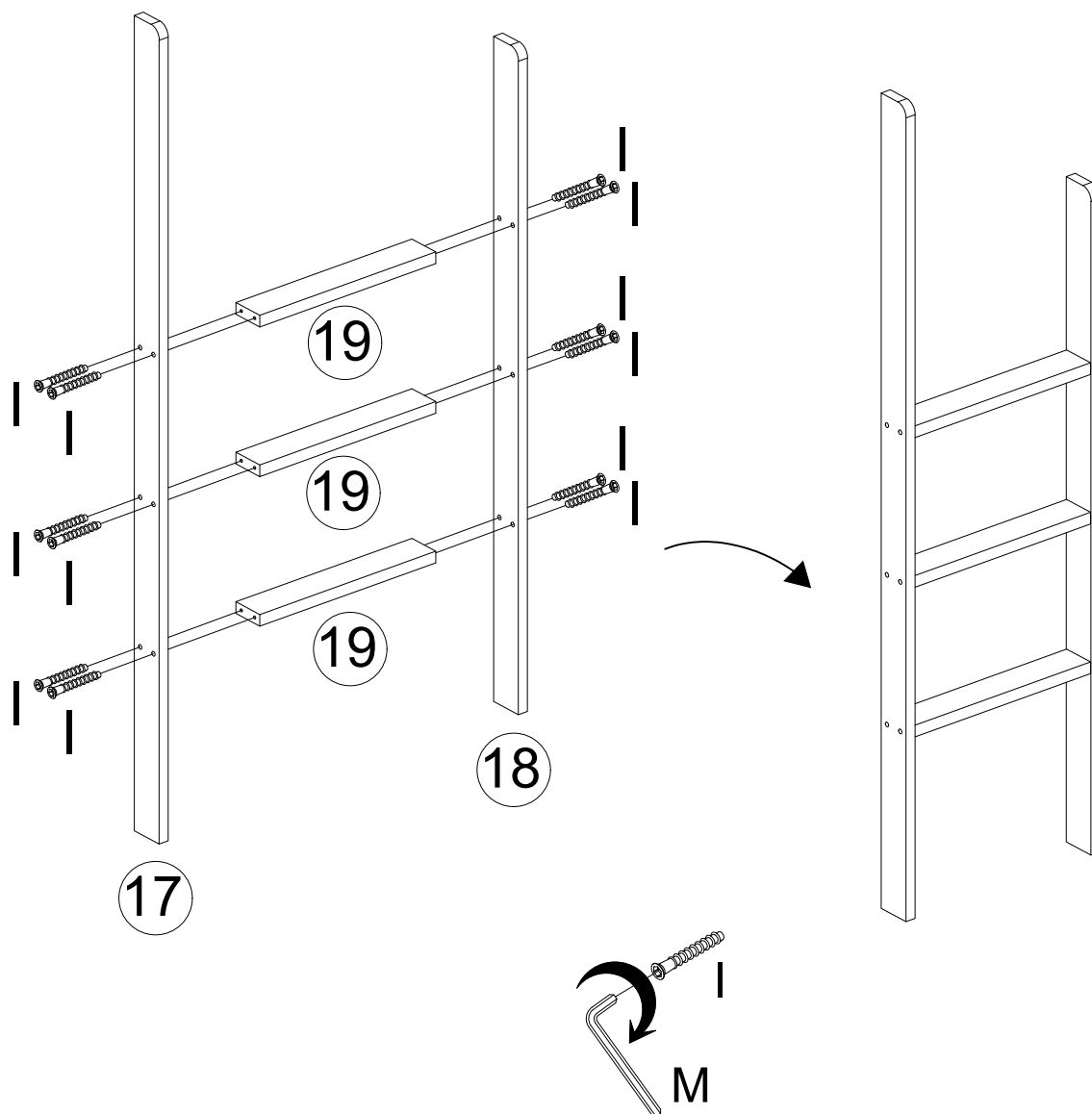
8





I	7x60		12PCS	M	M4		1PC
---	------	---	-------	---	----	--	-----

MONTAGEANLEITUNG/ASSEMBLY INSTRUCTIONS

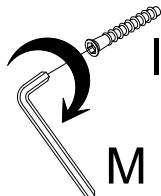
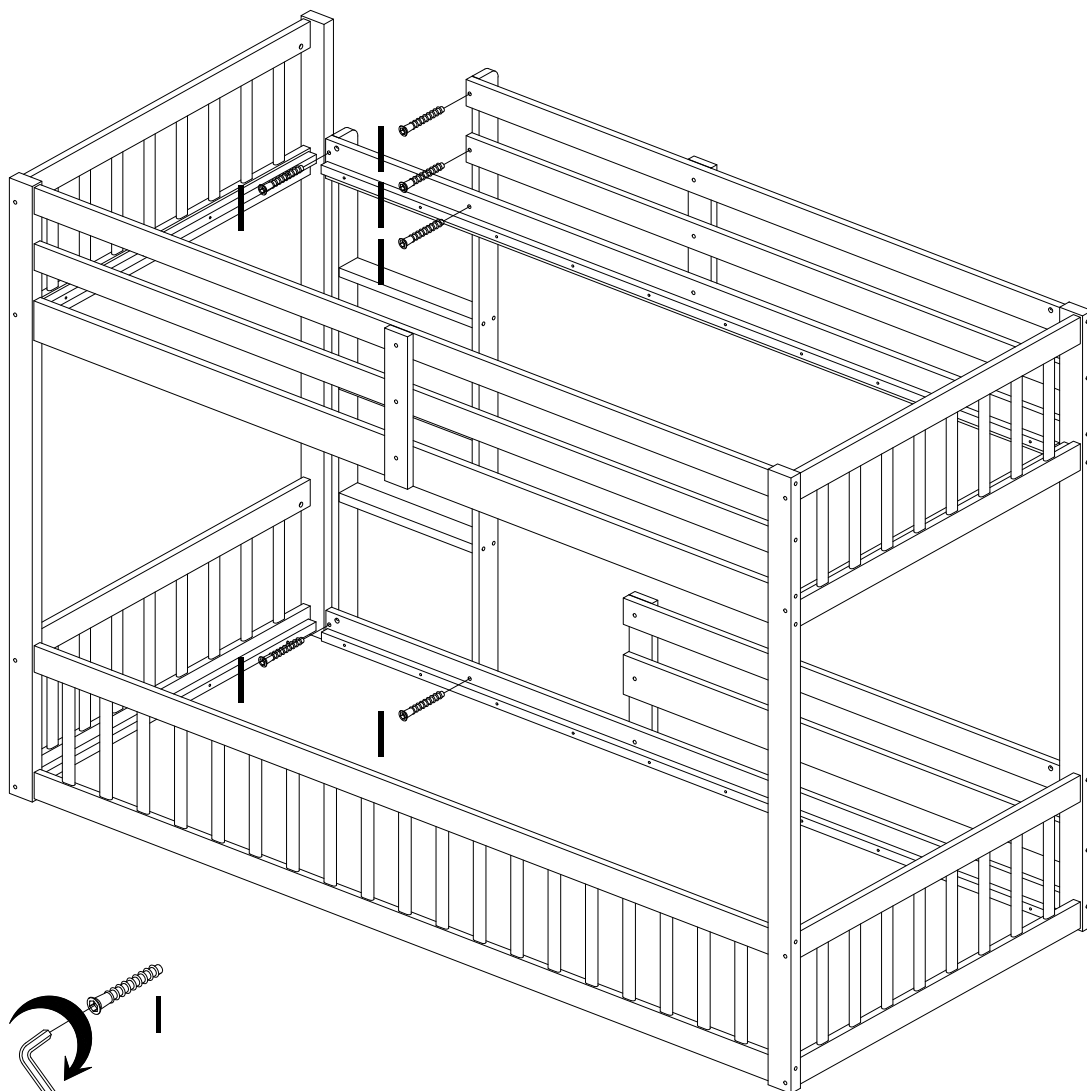
9





H	5x40	
---	------	---

I	7x60		6PCS	M	M4		1PC
---	------	---	------	---	----	--	-----

MONTAGEANLEITUNG/ASSEMBLY INSTRUCTIONS

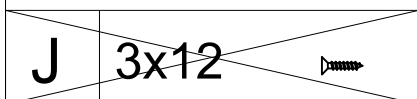
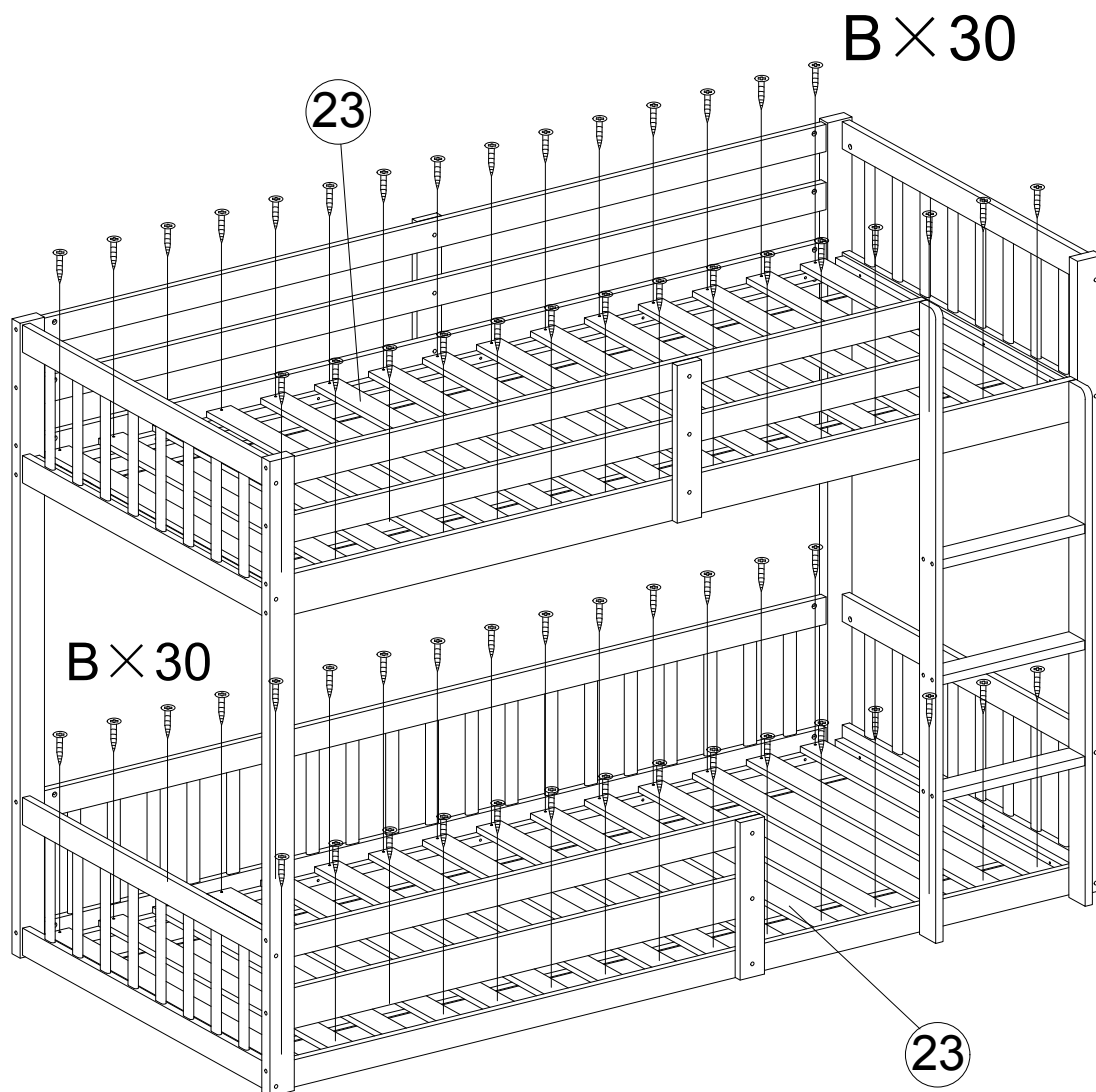
10





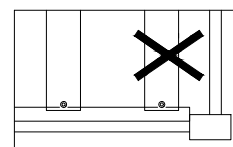
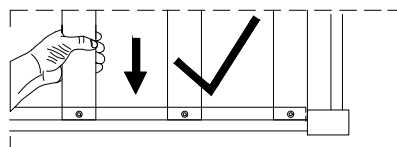

B	4x30		60PCS
N			1PC

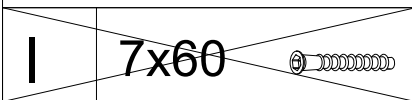
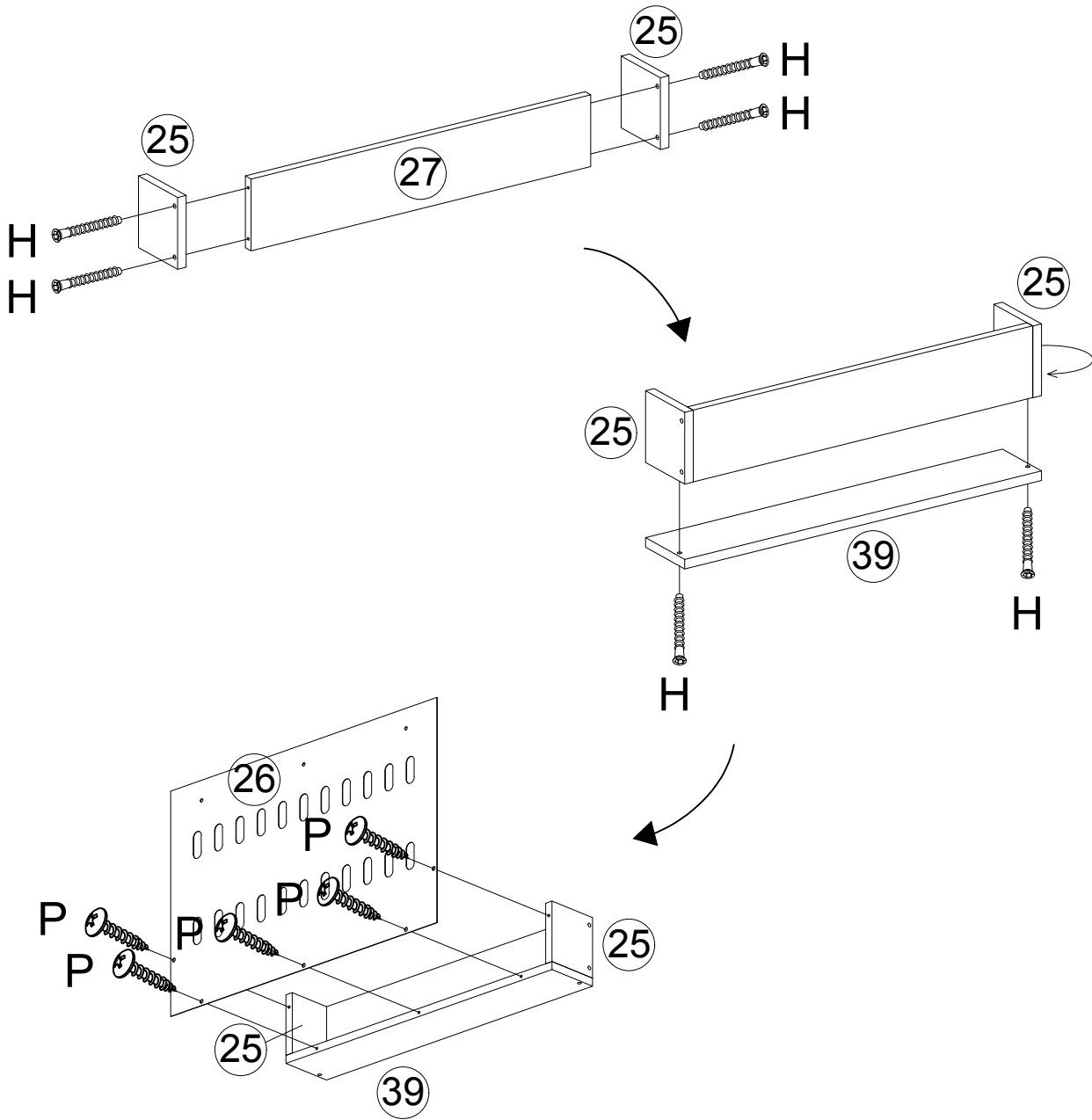

MONTAGEANLEITUNG/ASSEMBLY INSTRUCTIONS

11





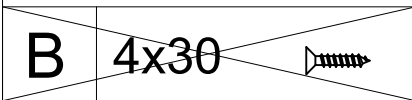
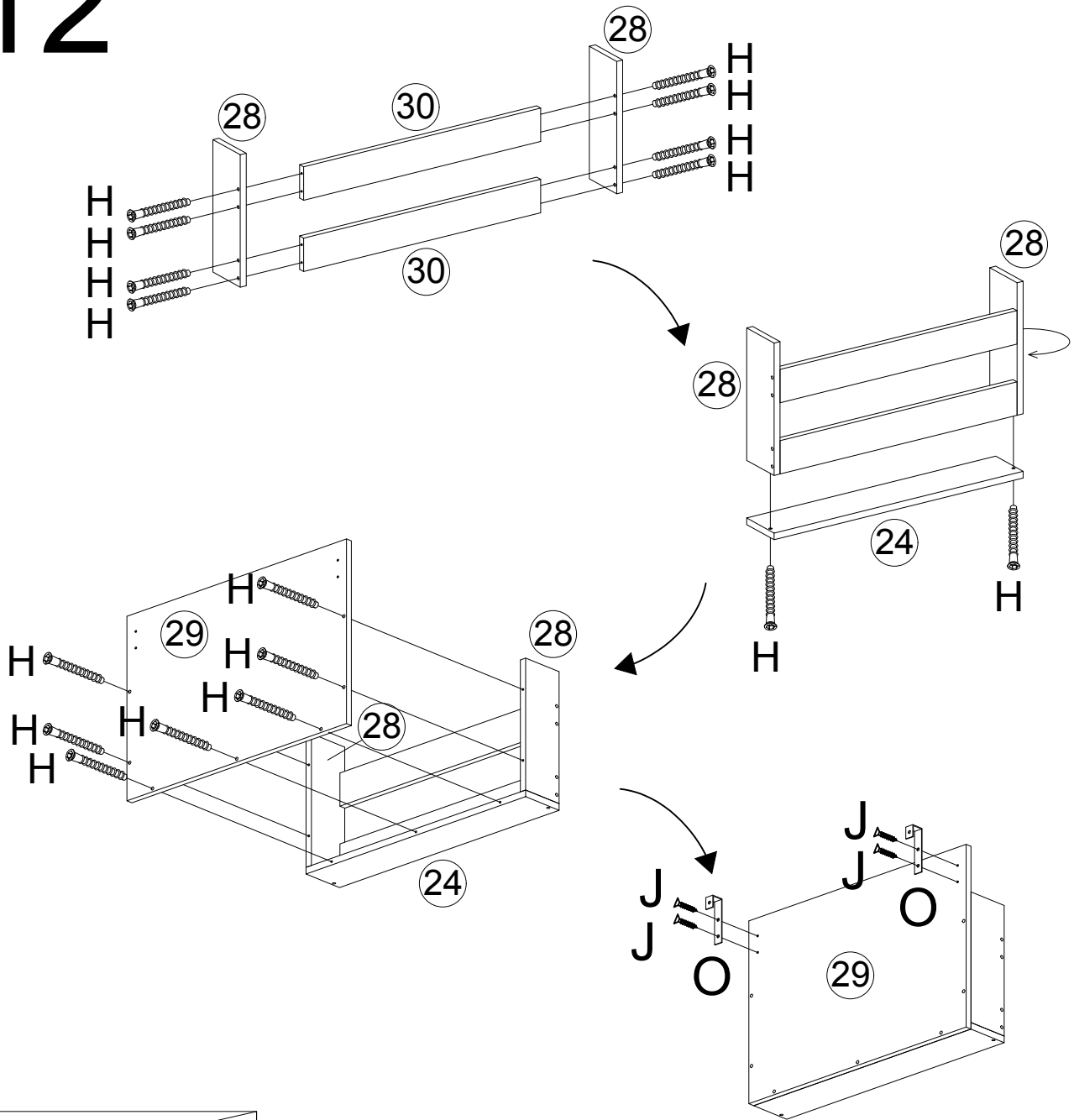

H	5x40		6PCS	P	3x16		5PCS
L	M3		1PC	N			1PC

MONTAGEANLEITUNG/ASSEMBLY INSTRUCTIONS

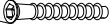
12





J	3x12		4PCS	I	7x60	
N			1PC	H	5x40	
O			2PCS	L	M3	

MONTAGEANLEITUNG/ASSEMBLY INSTRUCTIONS

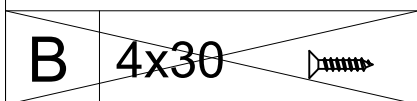
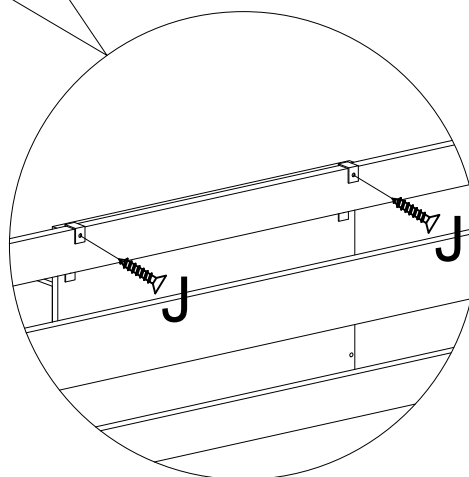
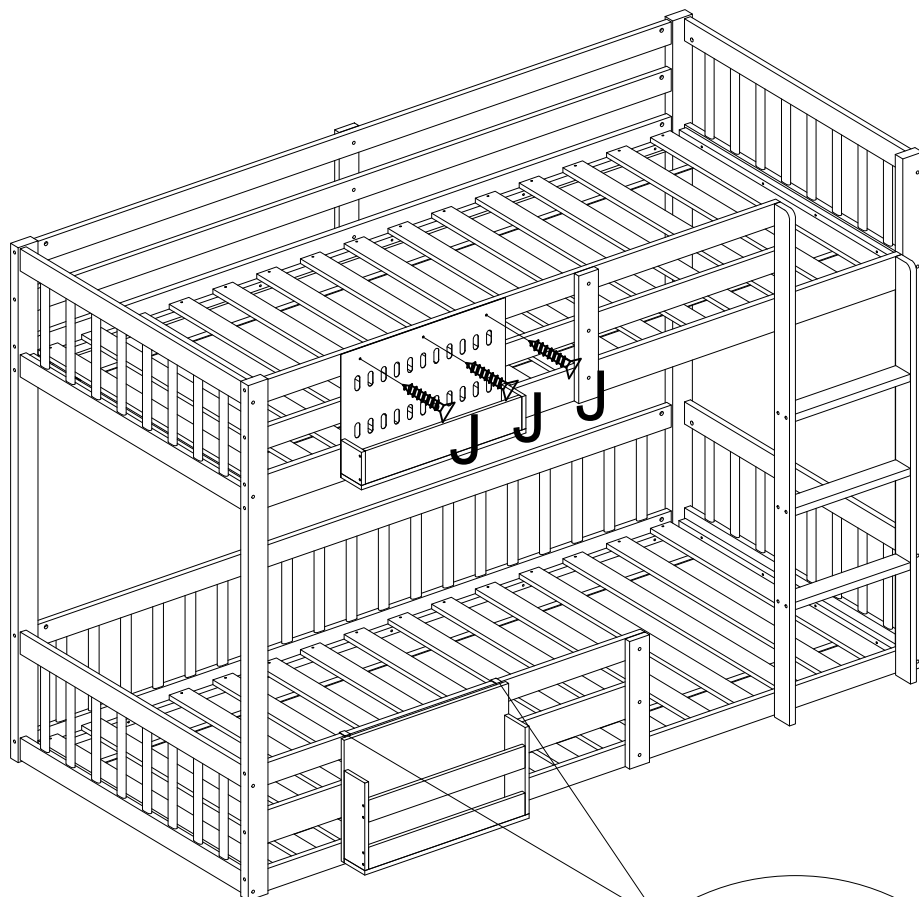
13



J	3x12		5PCS
N			1PC

MONTAGEANLEITUNG/ASSEMBLY INSTRUCTIONS

14

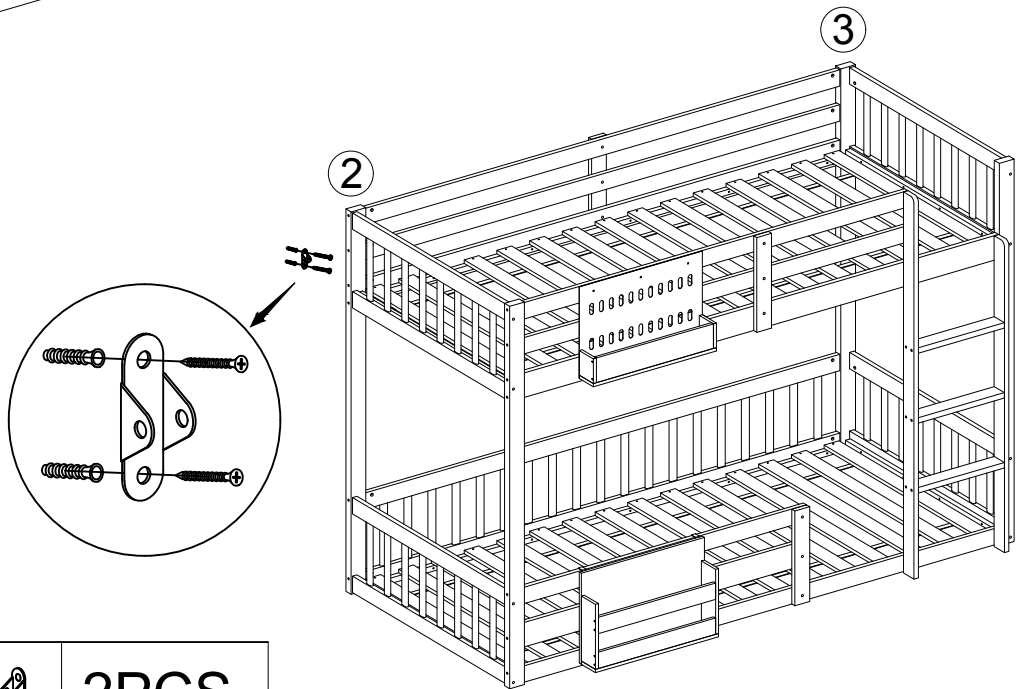
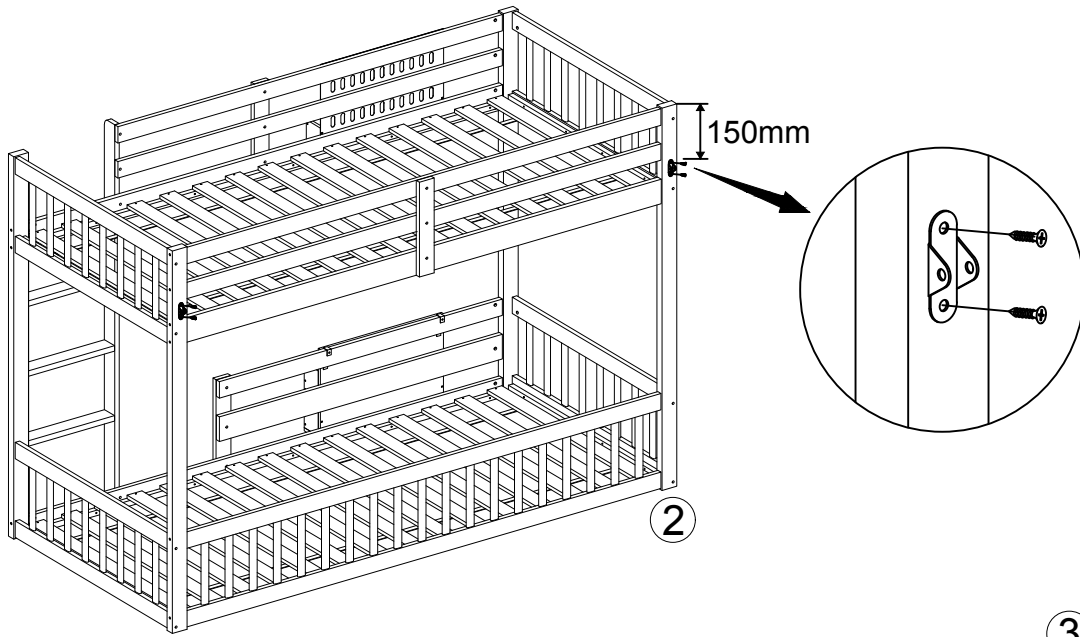
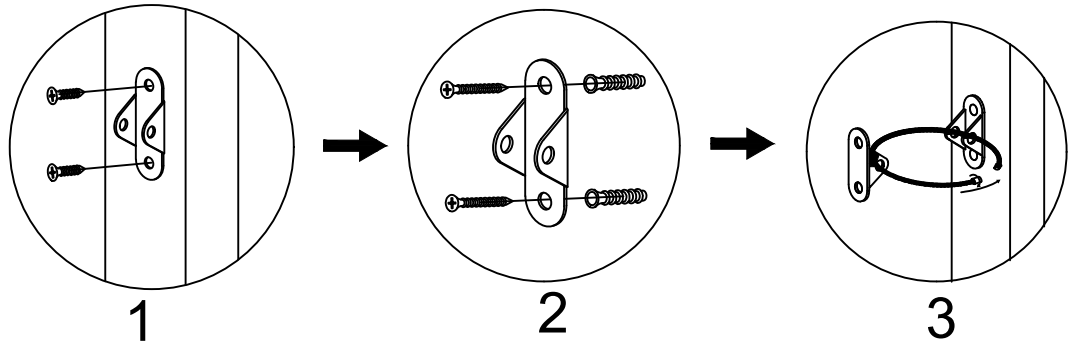

K		2PCS
N		1PC