

# SŁUPEK WYSOKI 1D 80-01-B-1D

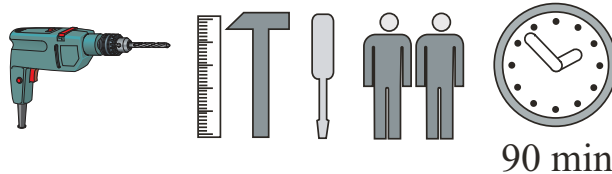

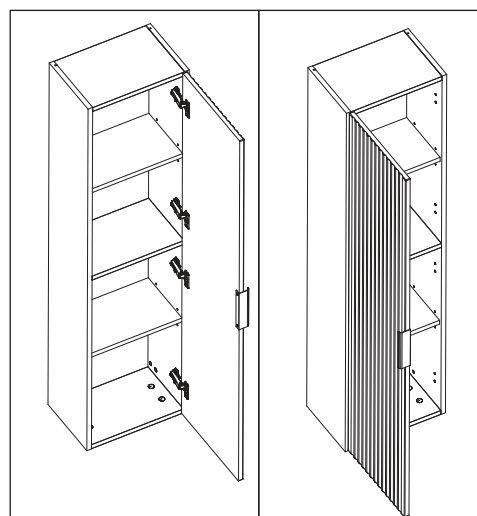

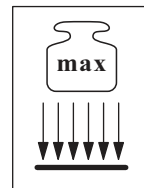

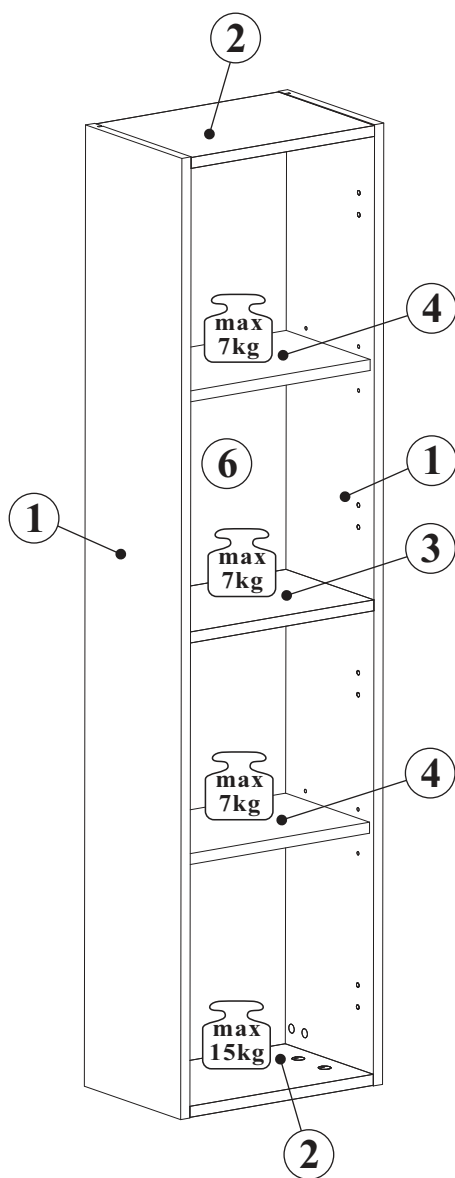
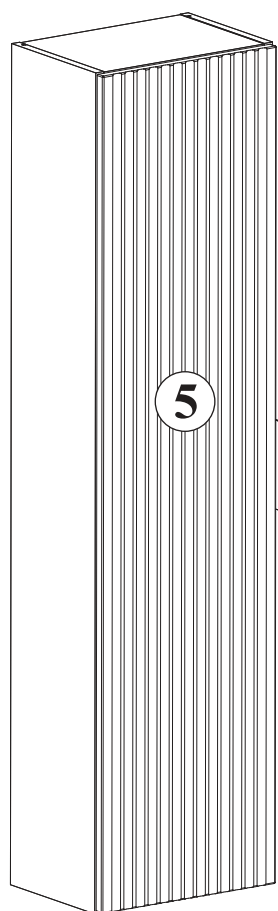
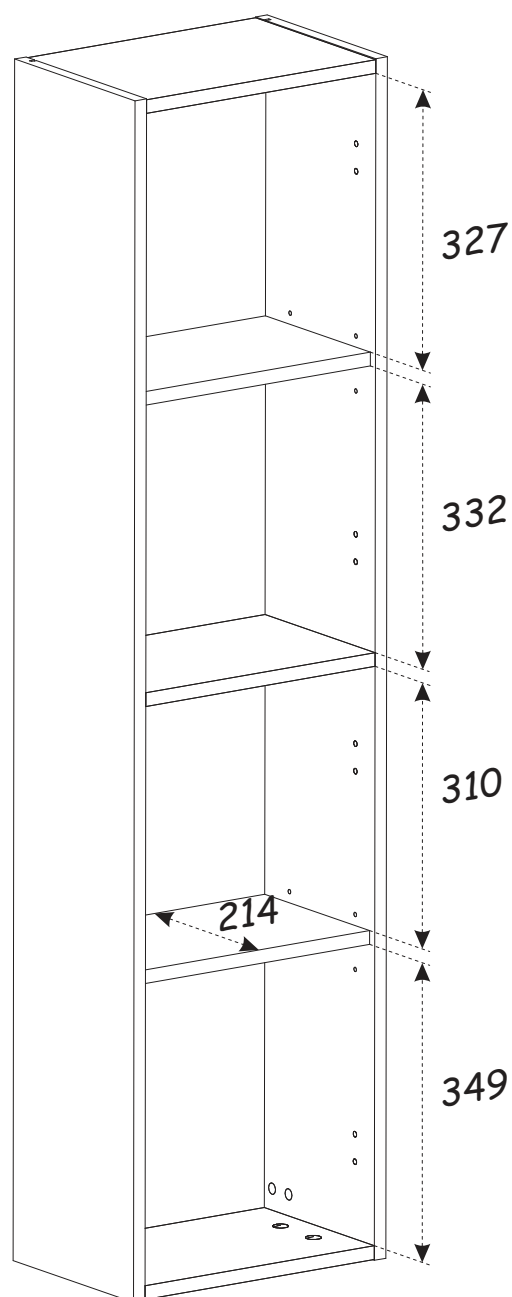
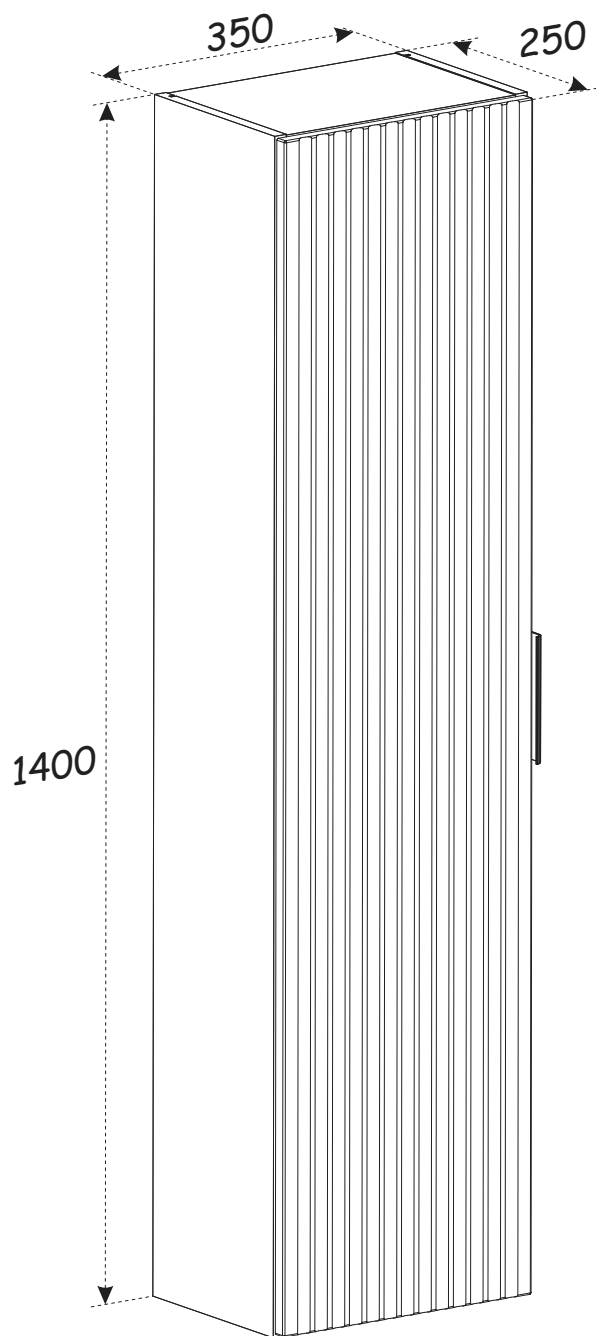

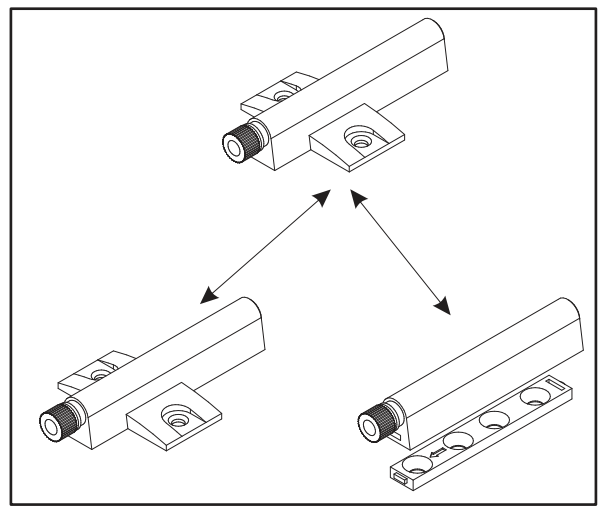
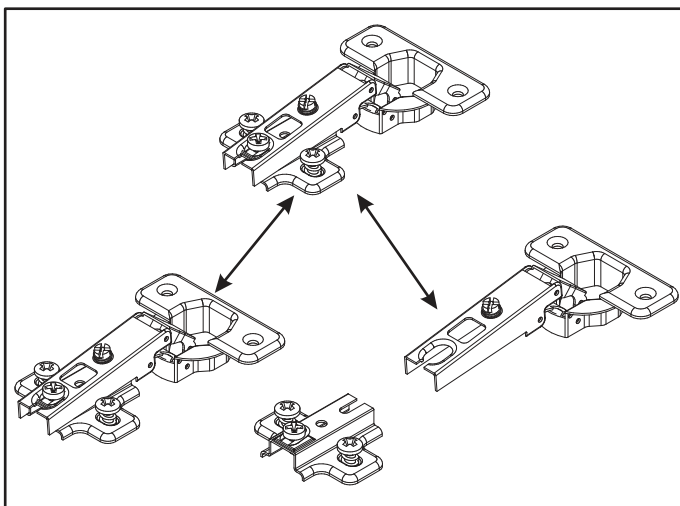
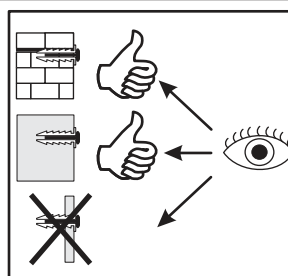
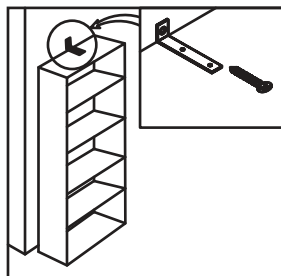
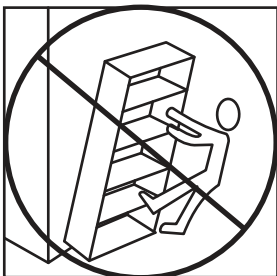
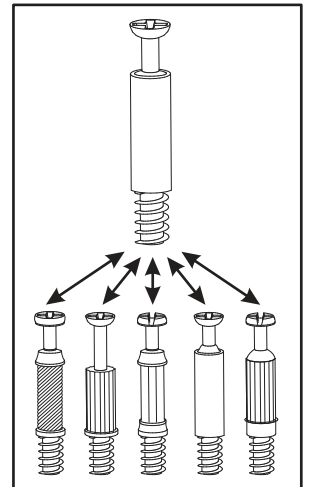
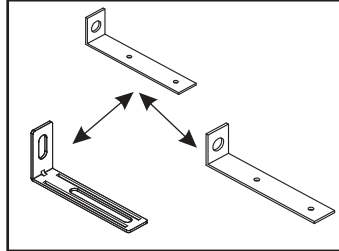
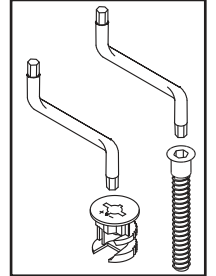
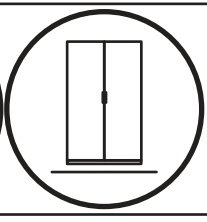
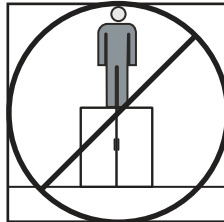
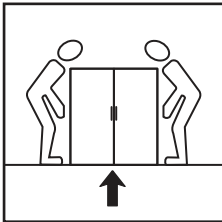
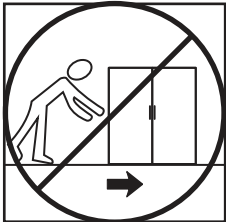
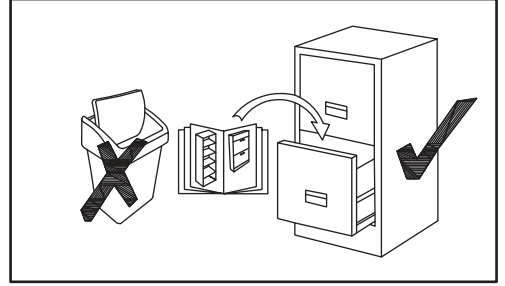
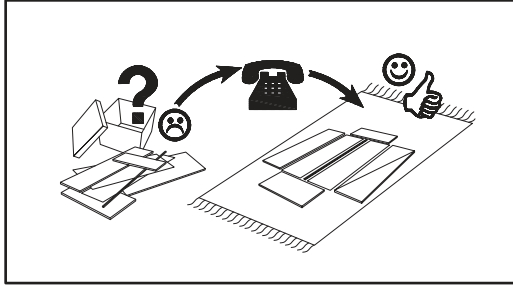
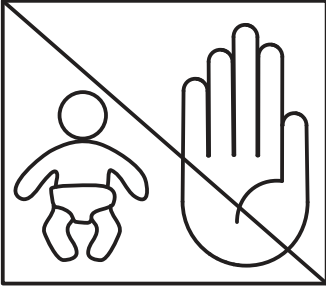
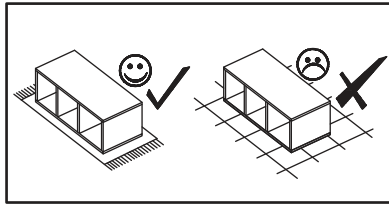
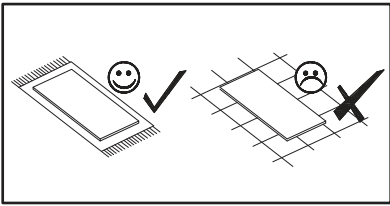



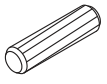
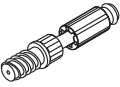

NO	Dim.			Col.-No	Qty
1	1400	234	16	1	2
2	318	234	16	1	2
3	318	214	16	1	1
4	318	204	16	1	2
5	1394	344	16	1	1
6	1378	330	3	1	1

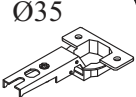
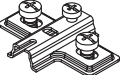
# SŁUPEK WYSOKI 1D 80-01-B-1D

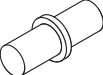

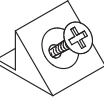

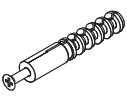
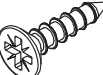
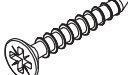
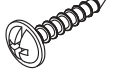

SŁUPEK WYSOKI 1D 80-01-B-1D

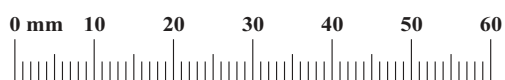
A1 x12 ø8x36		B4 x12		B5 x12 ø15x12		G5 x12		ZXP x1		ZXL x1	
E21 x4 Ø35 H=0		E2 x4 H=0		D10 x8 USØ3,5x13		G7 x8		Z2 x8 Ø5		Z5 x4 Ø10	
S1 x8		G04 x1 L-148mm.		SZ7 x2		KR1 x4		D7 x2 USØ3x16		D6 x4 USØ3,5x30	
UP13 x3 UPØ3x16		G2 x1									





1

D6	
x4	USØ3,5x30

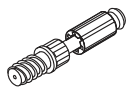
Z5	
x4	Ø10

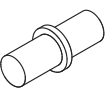
B4	
x12	

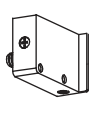

G7	
x8	

ZXP	
x1	

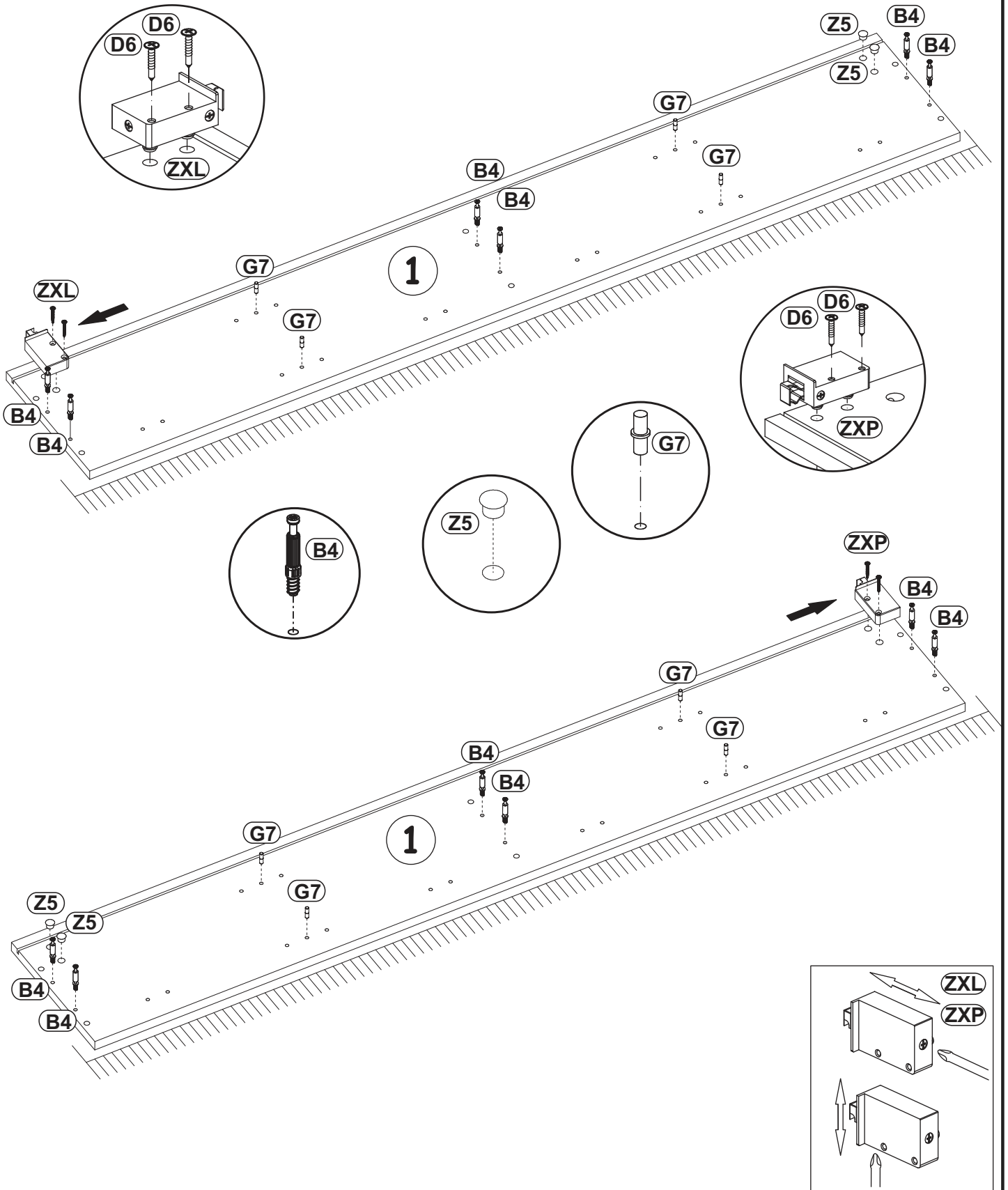
ZXL	
x1	



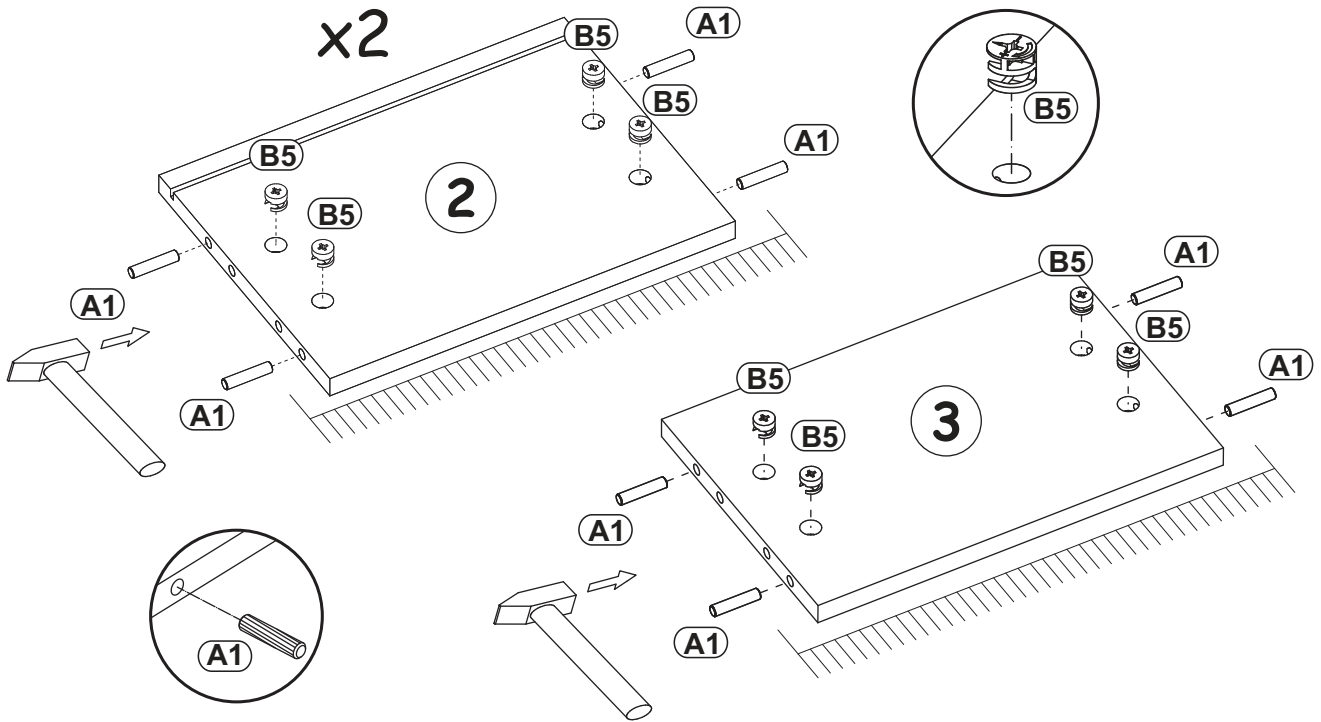

2

A1		B5	
x12	ø8x36	x12	ø15x12



3

D10		E21	
x8	USØ3,5x13	x4	Ø35 H=0

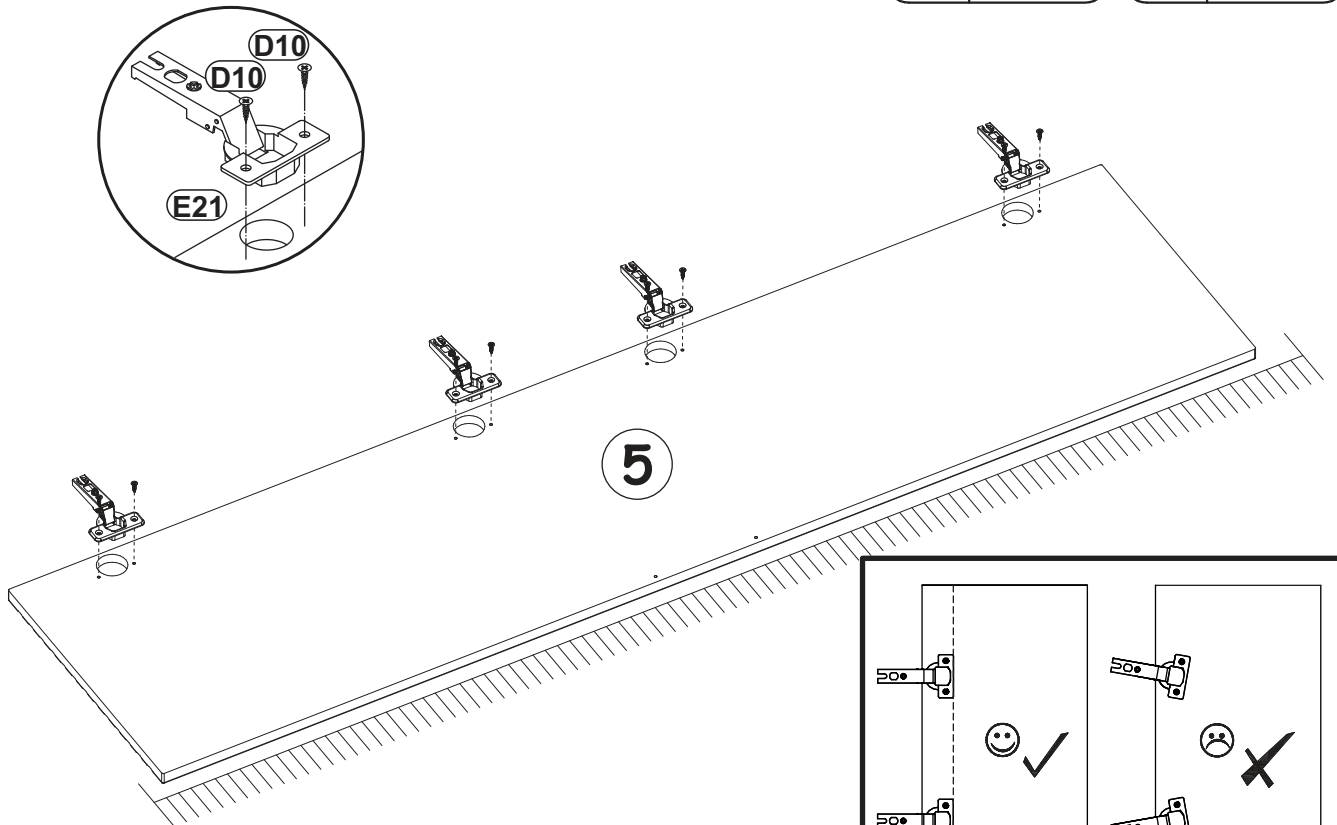

4

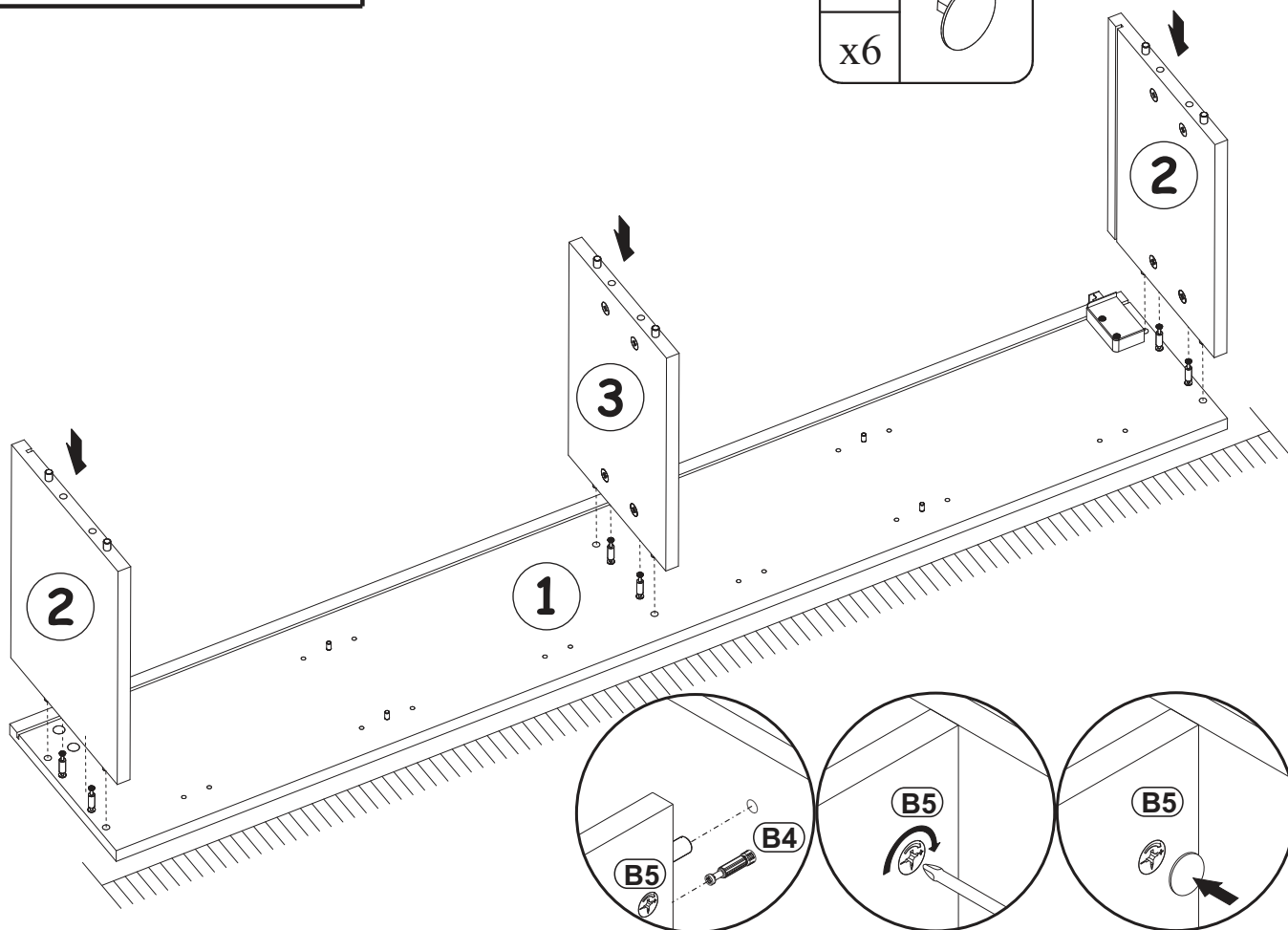
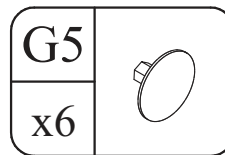

5

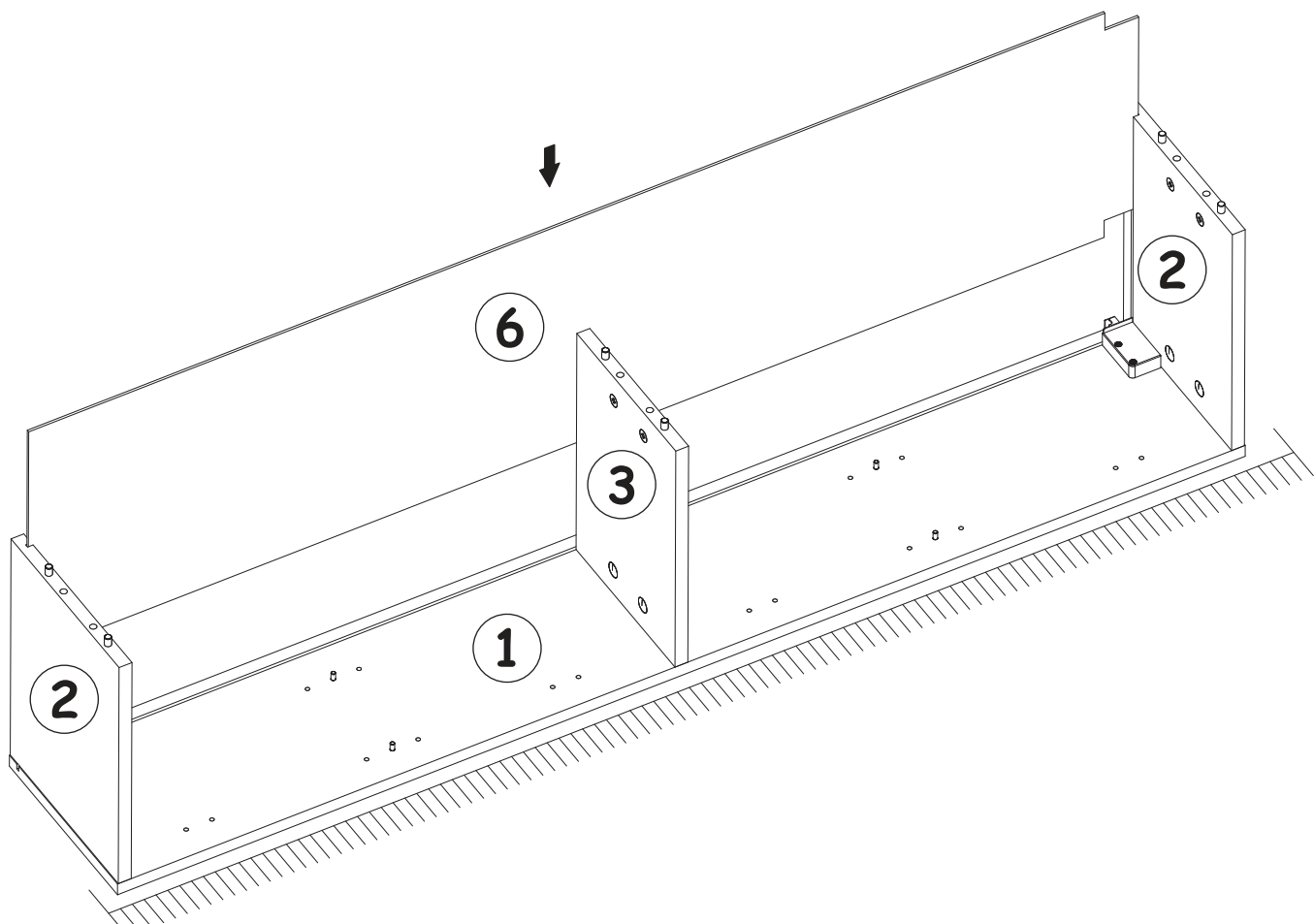

6

G5	
x6	

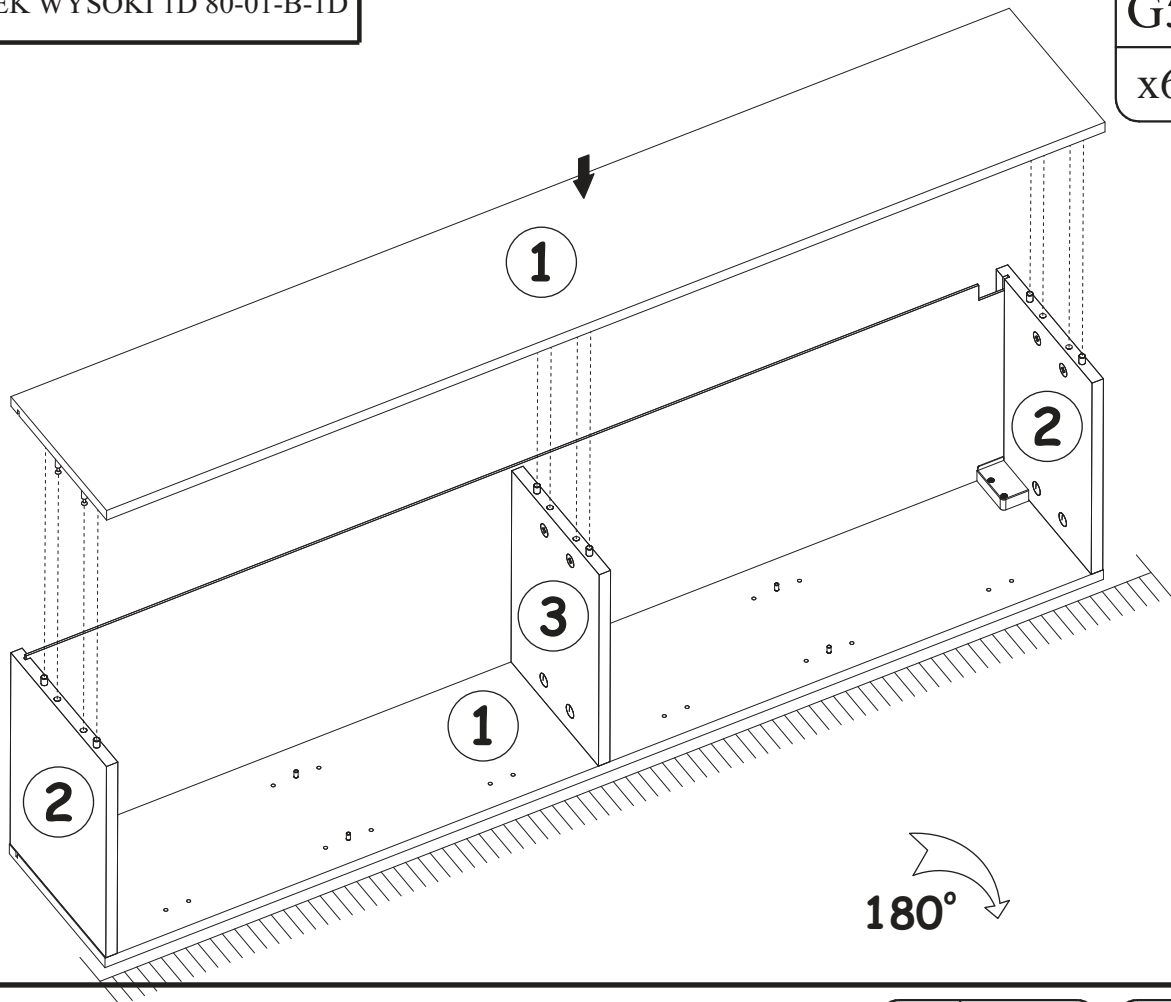

7

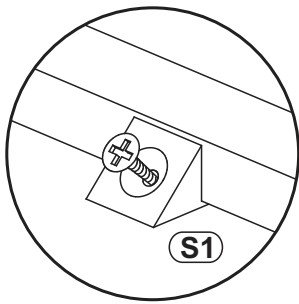

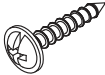
UP13	
x3	UP03x16

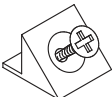
S1	
x8	

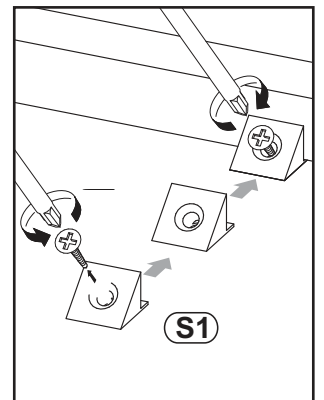
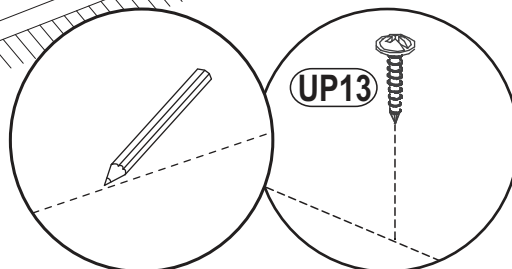
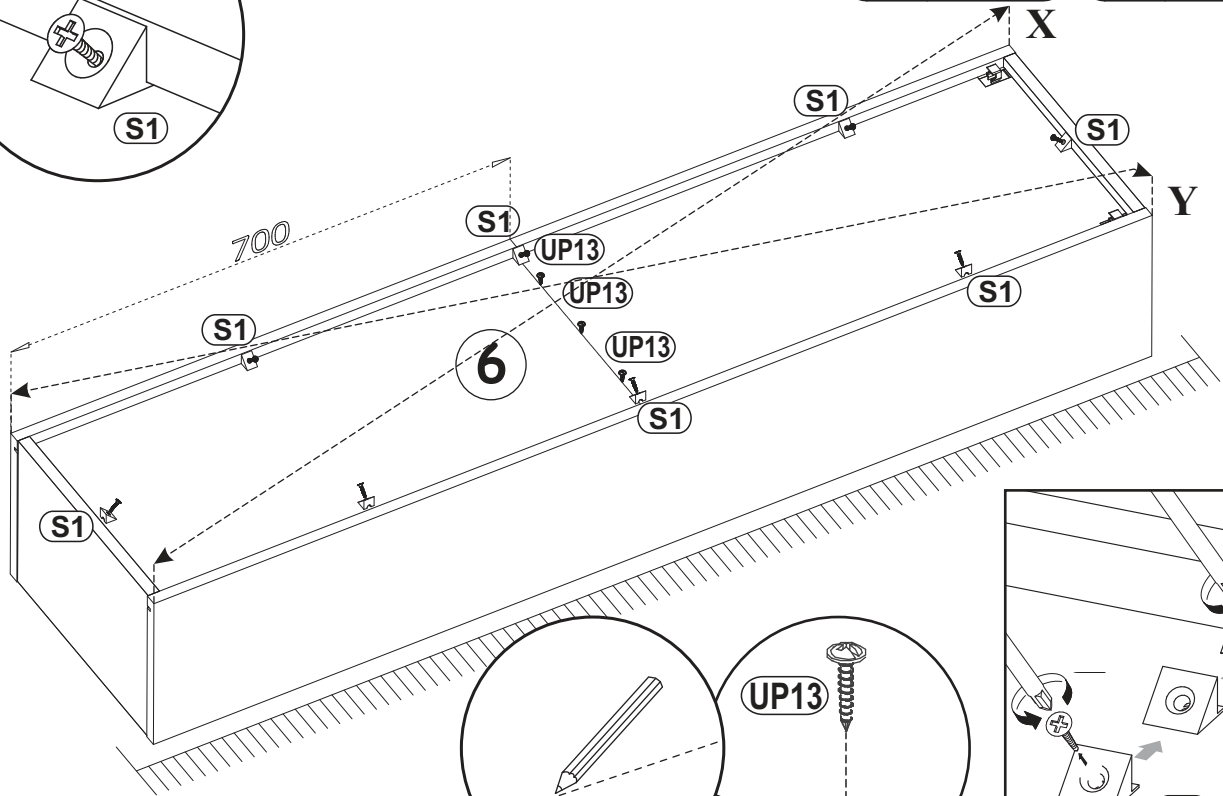

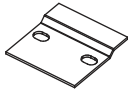
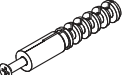

SZ7		KR1	
x2		x4	

8

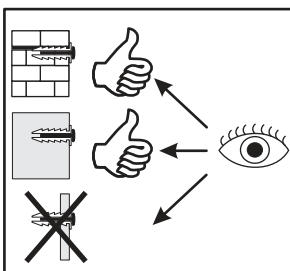
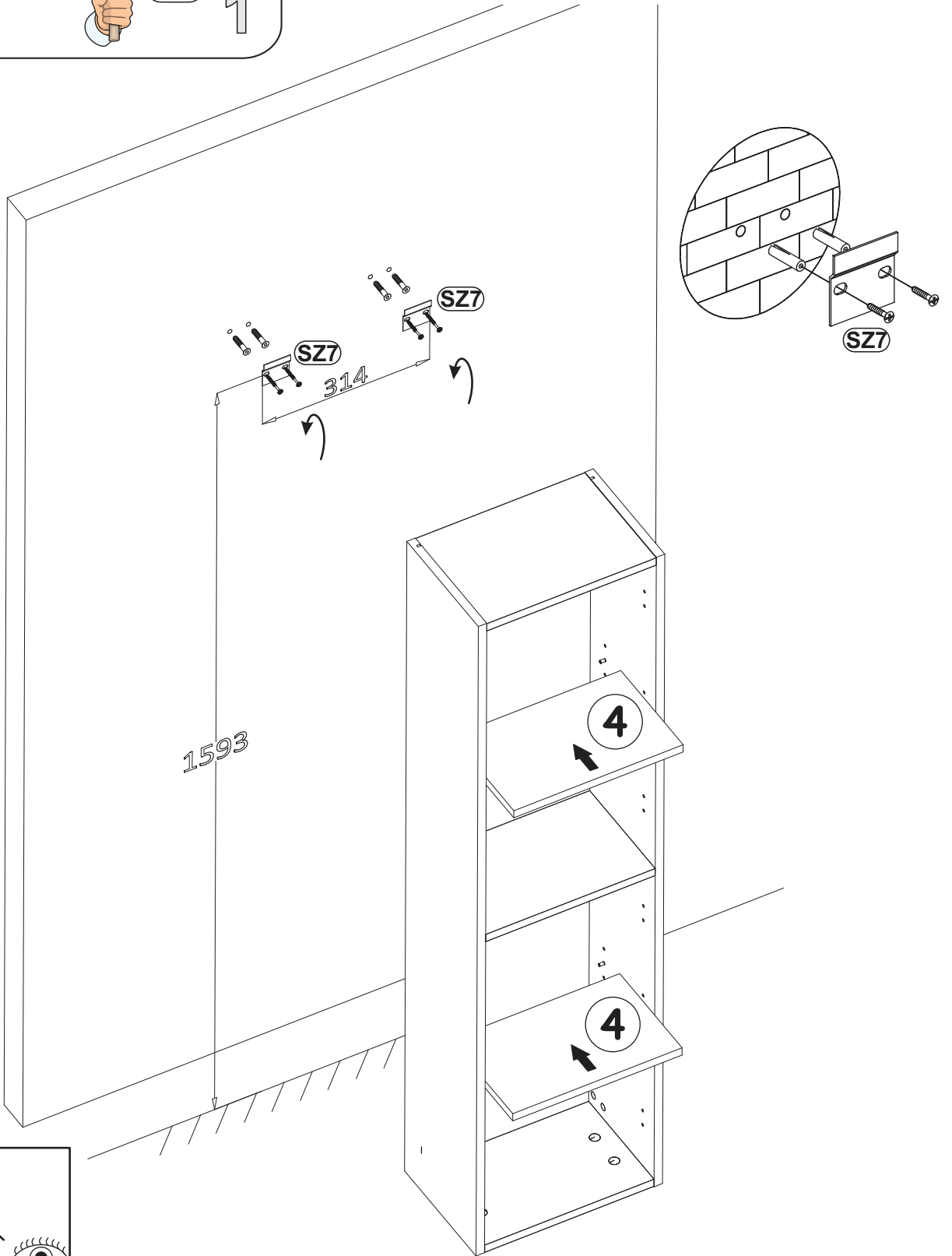
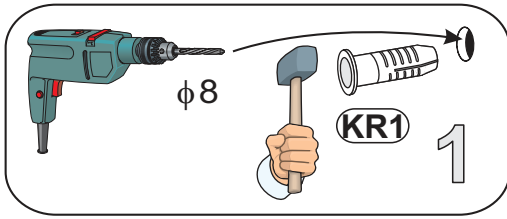

**9-11**

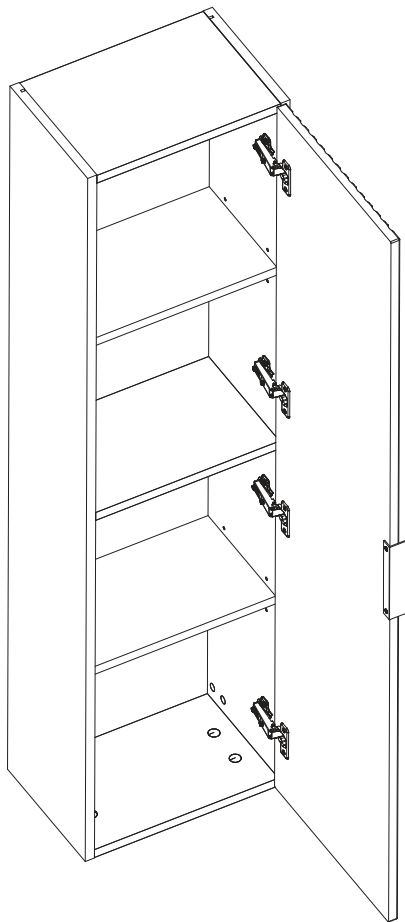

**12-14**

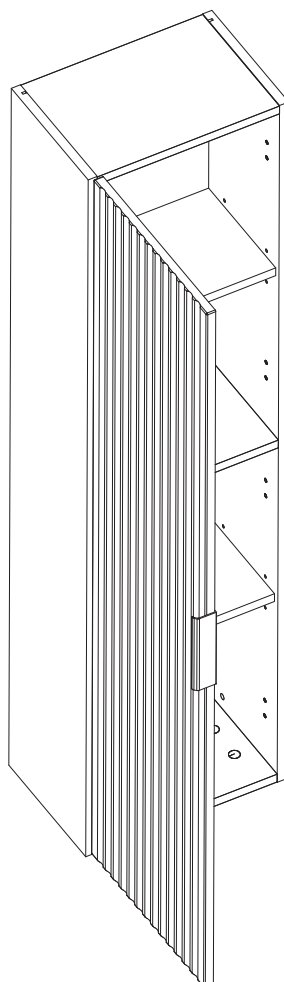

9

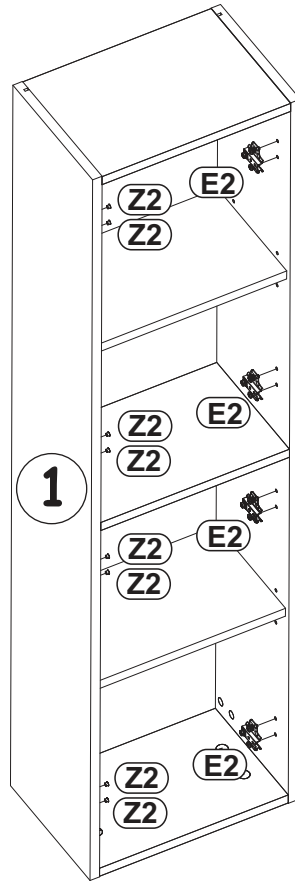
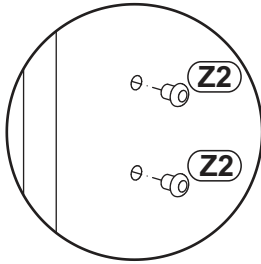
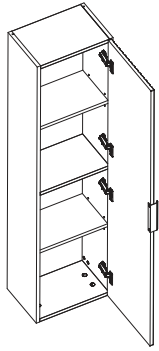

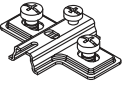
Z2		E2	
x8	Ø5	x4	H=0

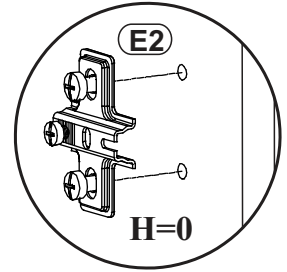

10

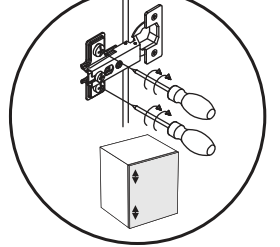
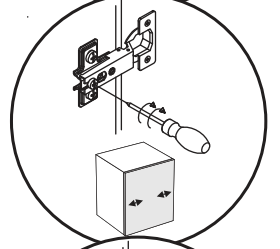
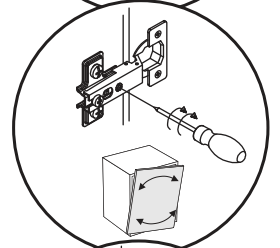
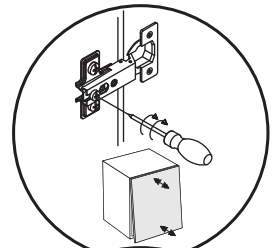
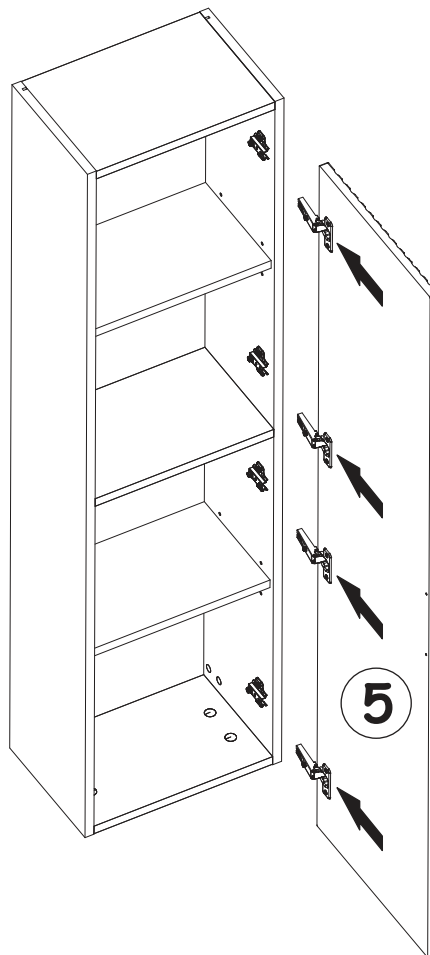
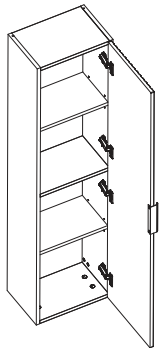

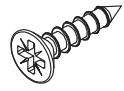
D7	
x2	USØ3x16

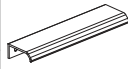
G04	
x1	L-148mm.

11

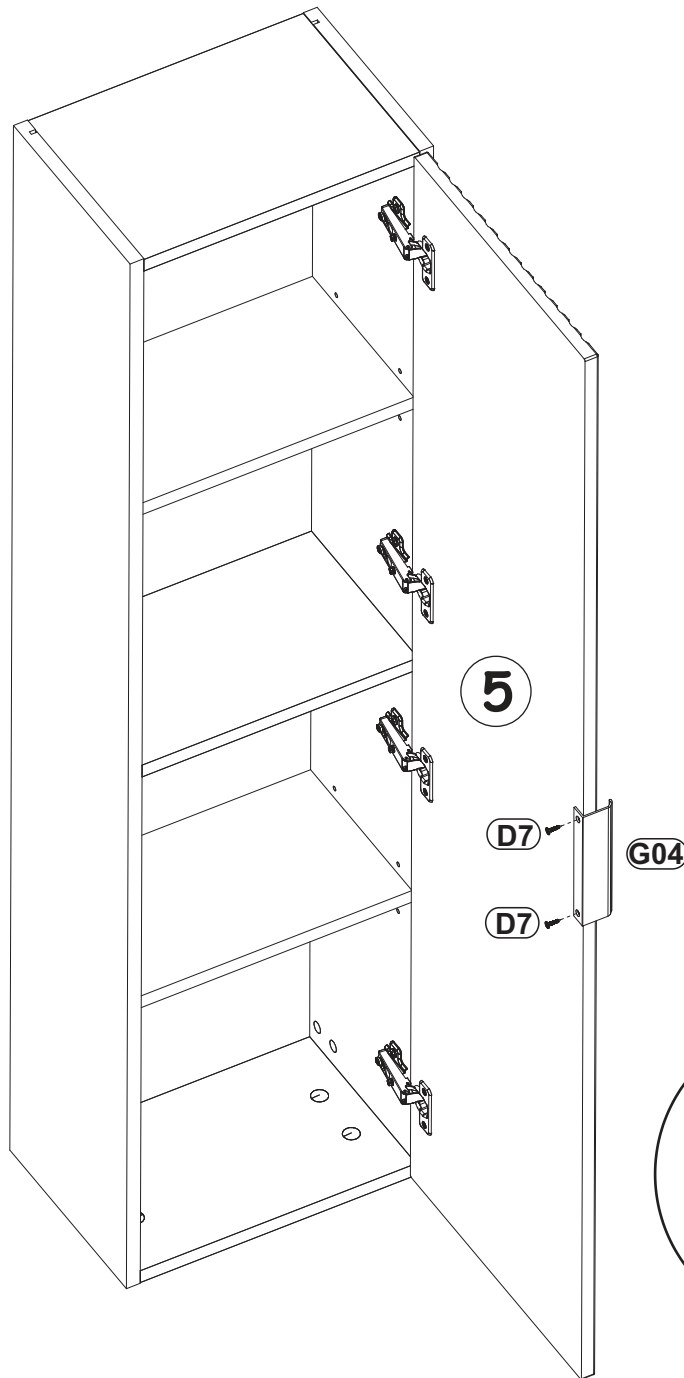
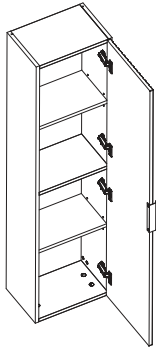

12

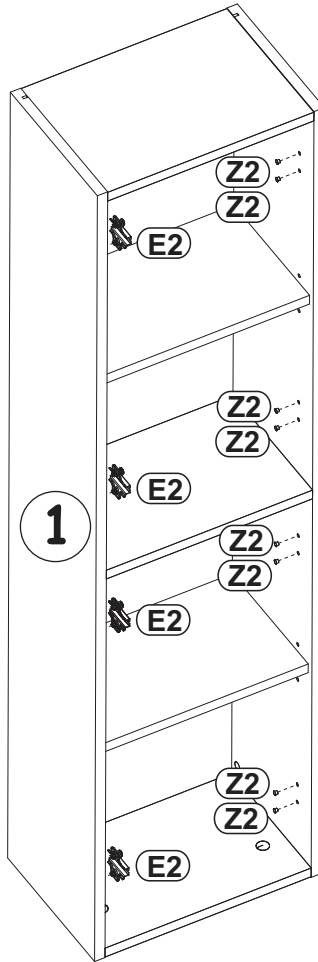
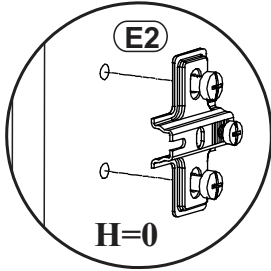
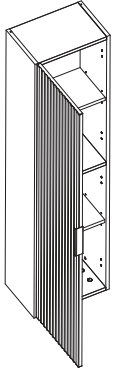

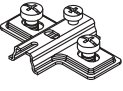
Z2		E2	
x8	Ø5	x4	H=0

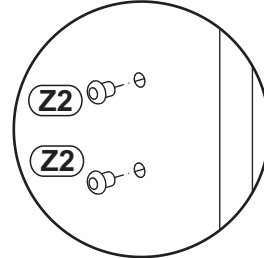

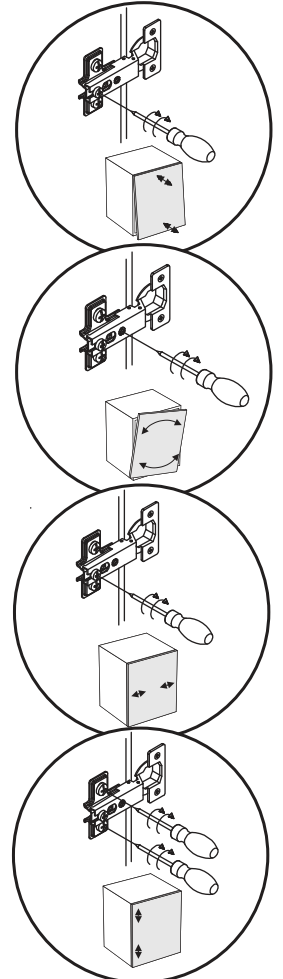
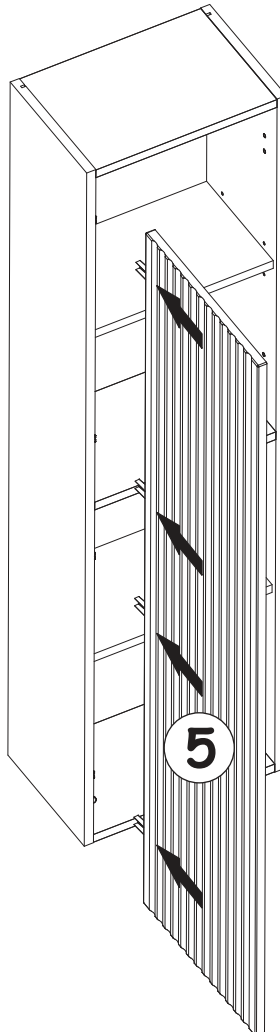
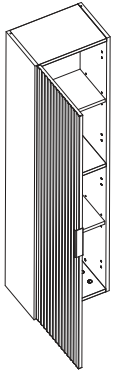

13

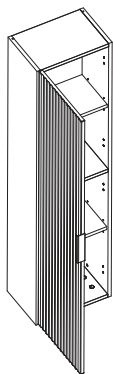

14

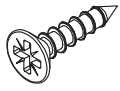

D7		G04	
x2	USØ3x16	x1	L-148mm.

