

ITEM NO.

① X 1	② X 1	③ X 1	④ X 1
⑤ X 1	⑥ X 1	⑦ X 2	⑧ X 2
⑨ X 2	⑩ X 2	⑪ X 2	⑫ X 1

A X 24 	B X 24 	C X 16 	D X 8 	E X 32
F X 4 	G X 2 	H X 2 		

1

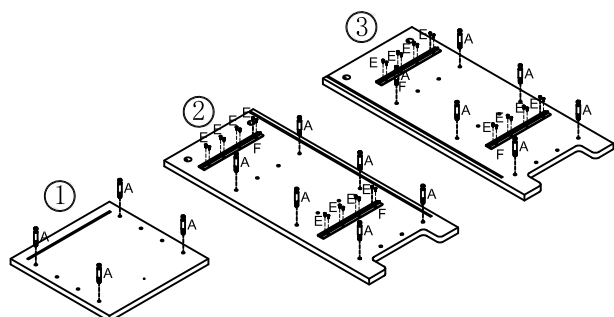

2

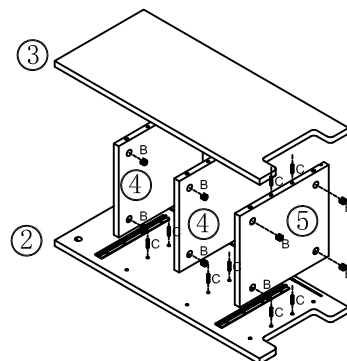

3

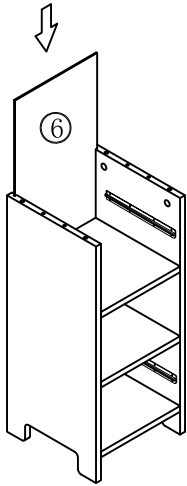

4

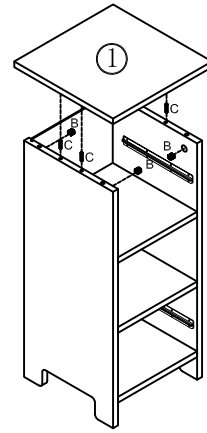

5

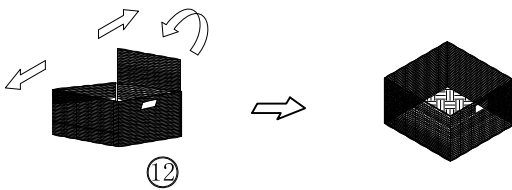
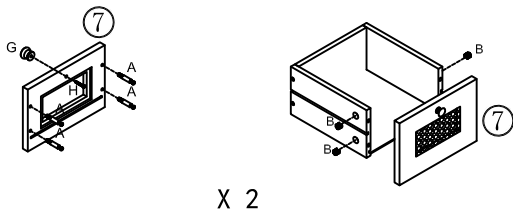
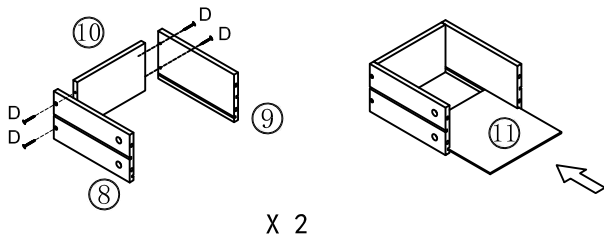

6

