

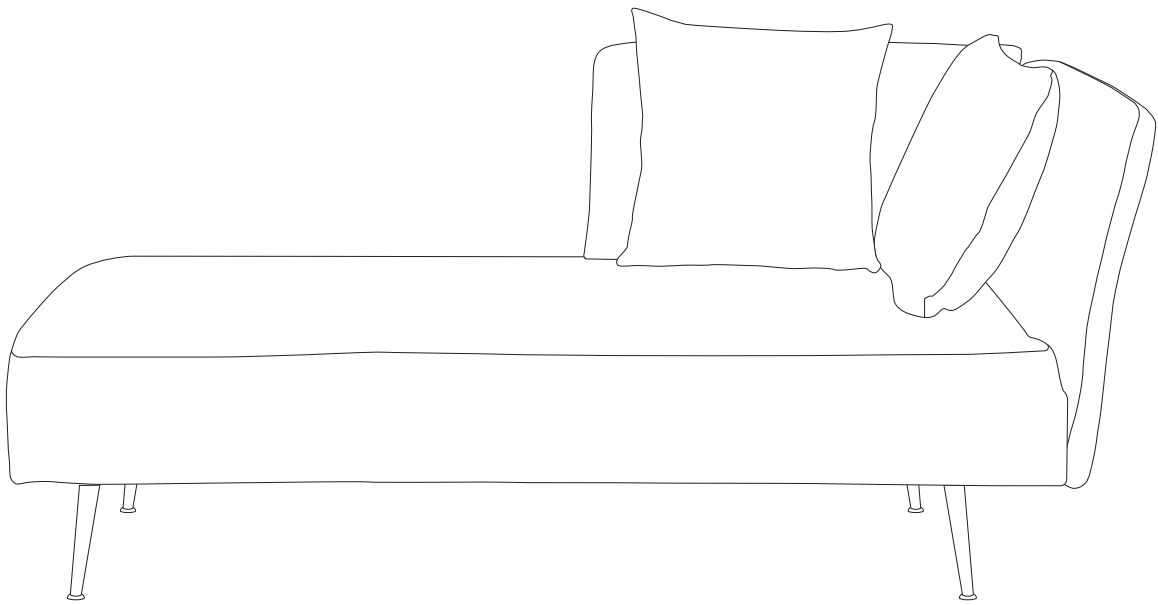

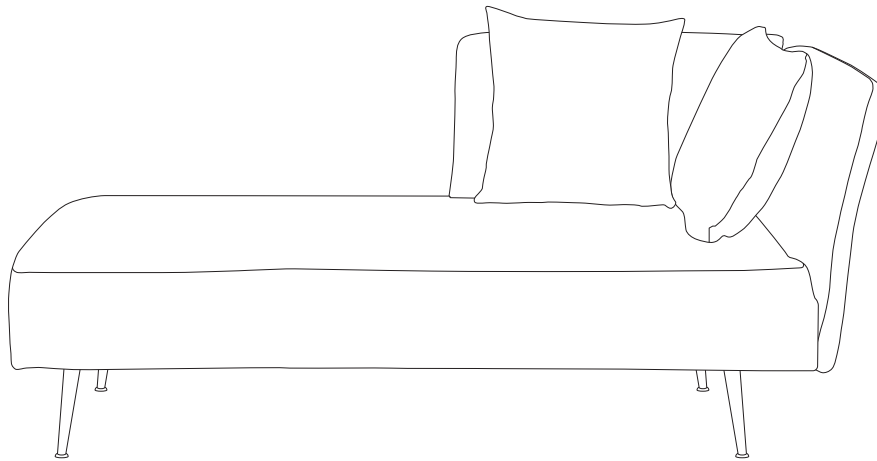

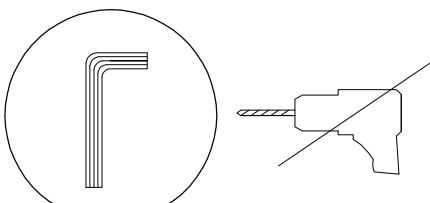

RIOM



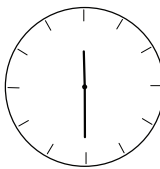
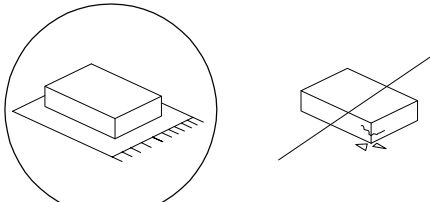

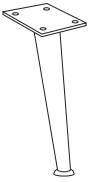
		
		<p>30'</p>
		
		<p>2</p>

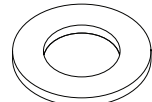
<p>A</p>  <p>x 4</p>	<p>B</p>  <p>x 1</p>	<p>C</p>  <p>x 16</p>	<p>D</p>  <p>x 16</p>
---	---	---	--

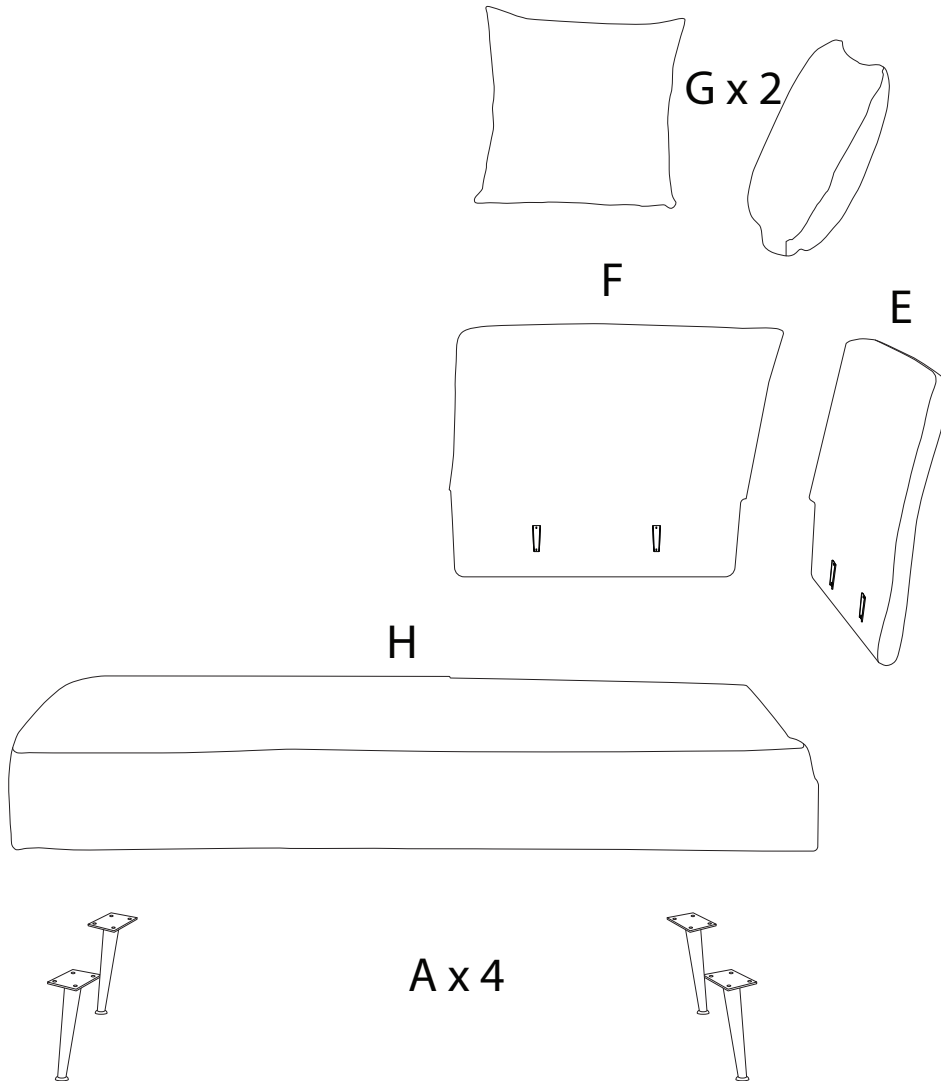

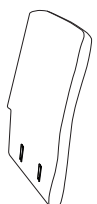
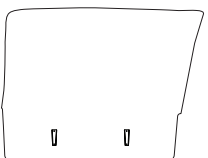
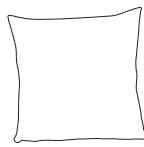
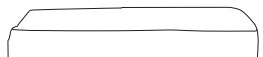

<p>E</p>  <p>x 1</p>	<p>F</p>  <p>x 1</p>	<p>G</p>  <p>x 2</p>	<p>H</p>  <p>x 1</p>
---	---	--	---

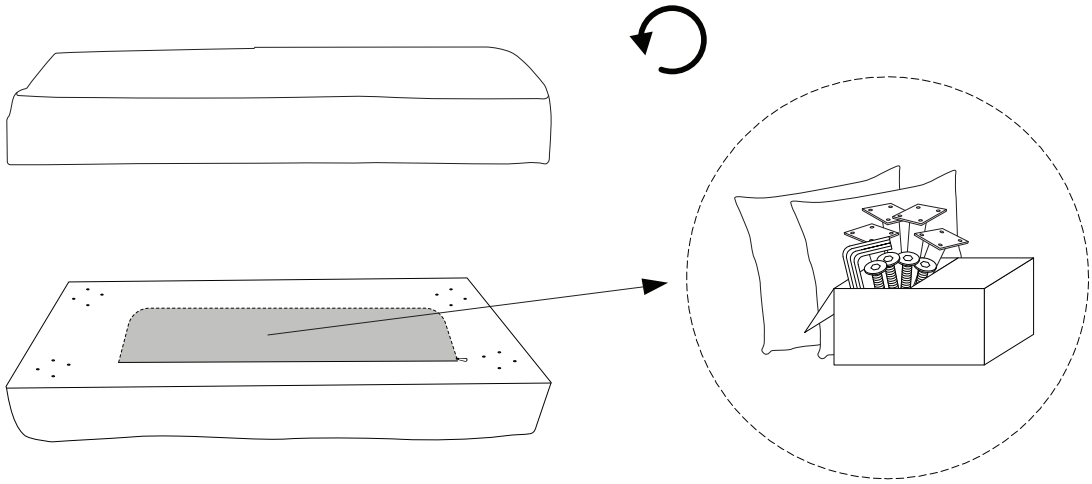
!

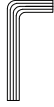
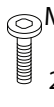

1

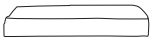
A  x 4	B  x 1	C  M6 x 20 x 16	D  x 16	H  x 1
--	--	---	---	--

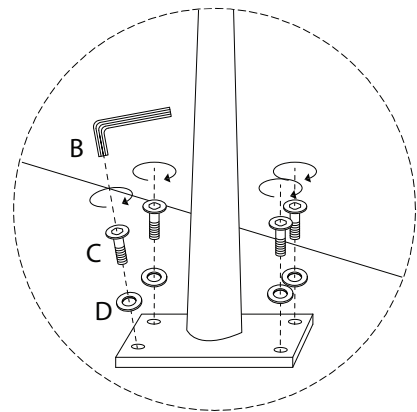
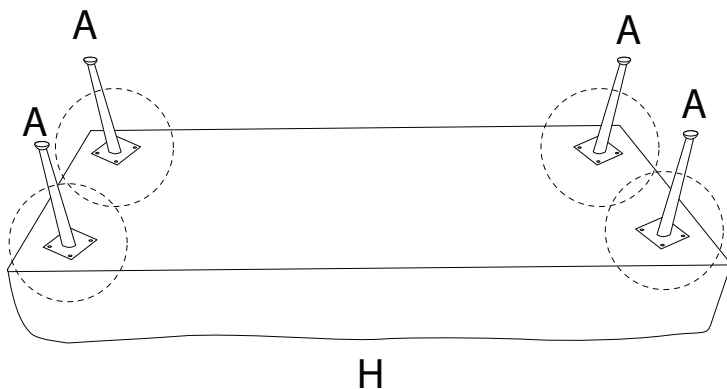

2

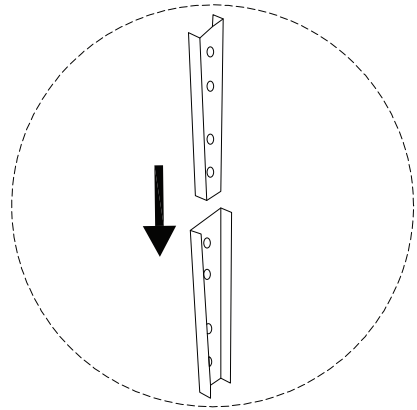
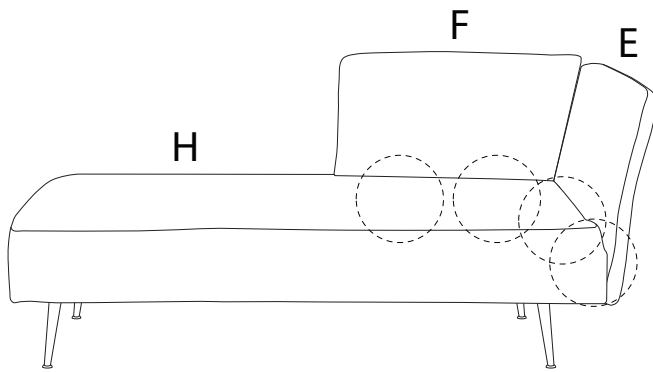
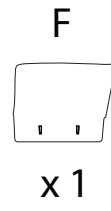

3

