

Installationsanleitung Installation Instruction Instructions d'installation

N623P433591
N623P433592
N623P433593
N623P433594

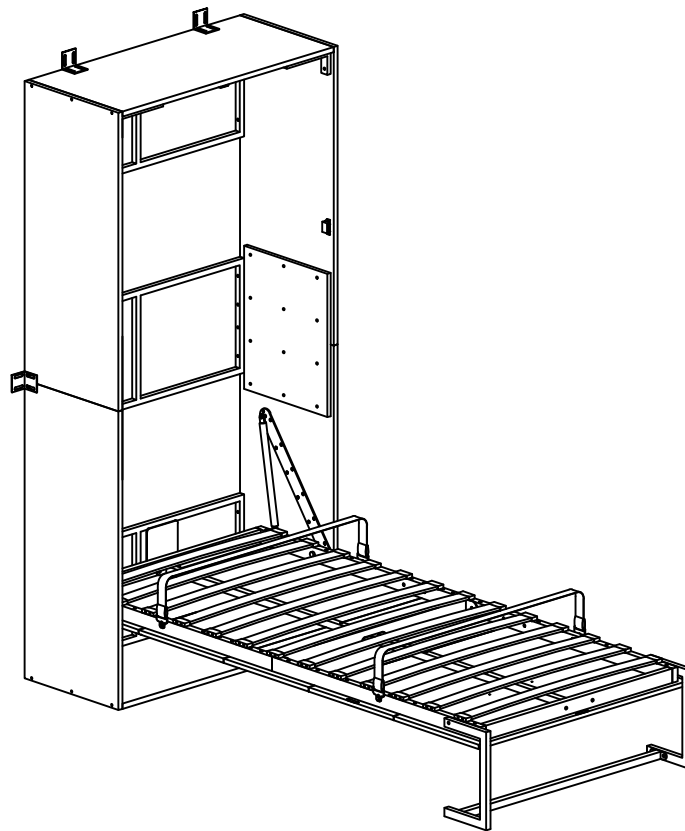

V3.0

DE: Unser Produkt wird Ihnen in 4 Paketen geliefert. Die Lieferzeiten dieser 4 Pakete können abweichen, bitte haben Sie etwas Geduld und vielen Dank für Ihr Verständnis.

UK: Our product will be delivered to you in 4 packages. The delivery times of these 4 packages may differ, please be patient and thank you for your understanding.

FR: Notre produit vous sera livré en 4 colis. Les délais de livraison de ces 4 colis peuvent différer, soyez patient et merci pour votre compréhension.

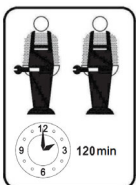

DE:Vor dem Einbau die Schrauben in die Löcher stecken und festziehen, aber nicht bis 100%, 70% bis 80% anziehen reicht aus. Schließlich, nachdem alle Schrauben installiert sind, ziehen Sie alle Schrauben auf 100%.Wenn Sie auf diese Probleme stoßen, wie z. B. Fehlausrichtung der Löcher oder Unfähigkeit, bestimmte Teile zu installieren, überprüfen Sie bitte, ob die Schrauben korrekt verwendet werden und passen Sie die Dichtigkeit der Schrauben an.

UK:Before installation, insert the screws into the holes and tighten them, but do not tighten them to 100%, 70% to 80% is sufficient. Finally, after all screws are installed, tighten all screws to 100%.If you encounter these issues, such as if the holes cannot be aligned or some parts cannot be installed, please check if the screws are used correctly and adjust the tightness of the screws.

FR:Insérer la vis dans le trou avant la fin de l'assemblage, serrer la vis, mais ne pas serrer à 100%, 70% ~ 80% est correct. Enfin, une fois que toutes les vis sont bien serrées, toutes les vis sont serrées à 100%.Si vous rencontrez ces problèmes, par exemple si les trous ne sont pas alignés ou si certaines pièces ne peuvent pas être montées, vérifiez que les vis sont utilisées correctement et Ajustez leur serrage.

English

IMPORTANT FOR GAS LIFT BEDS&MAINTAINCE

- Please place the mattress on top of the bed frame.
- Please do not pull on the strap handles.
- Please press heavily to release the compressed gas.
- Periodically check all screw & fixings to ensure they are secure.
- When moving your product, carefully lift into place.
- Wipe clean with a slightly damp cloth- please do not use abrasive chemicals or bleach.
- Do NOT allow children to operate the lift mechanism.
- Do NOT allow children near the lift base when operating the mechanism.
- Do NOT stand inside the bed or the internal storage base.
- Do NOT overload the internal storage base.
- DO NOT jump on the product or any of its parts.

Deutsch

WICHTIG FÜR GASLIFT-BETTEN&WARTUNG

- Bitte legen Sie die Matratze oben auf den Bettrahmen.
- Bitte ziehen Sie nicht an den Gurtgriffen.
- Bitte drücken Sie kräftig, um das komprimierte Gas freizusetzen.
- Überprüfen Sie regelmäßig alle Schrauben und Befestigungen, um sicherzustellen, dass sie sicher sind.
- Wenn Sie Ihr Produkt bewegen, heben Sie es vorsichtig an seinen Platz.
- Mit einem leicht feuchten Tuch abwischen - bitte keine scheuernden Chemikalien oder Bleichmittel verwenden.
- Erlauben Sie Kindern NICHT, den Hebemechanismus zu bedienen.
- Lassen Sie Kinder NICHT in die Nähe des Liftsockels, wenn Sie den Mechanismus bedienen.
- Stellen Sie sich NICHT in das Bett oder in die Innenablage.
- Überlasten Sie den internen Liftsockel NICHT.
- Springen Sie NICHT auf das Produkt oder eines seiner Teile.

Français

IMPORTANT POUR LES LITS À RELEVAGE DE GAZ&MAINTENANCE

- Veuillez placer le matelas sur le dessus du cadre de lit.
- Ne tirez pas sur les poignées de la sangle.
- Appuyez fortement pour libérer le gaz comprimé.
- Vérifiez régulièrement que toutes les vis et fixations sont bien en place.
- Lorsque vous déplacez votre produit, soulevez-le avec précaution pour le mettre en place.
- Nettoyez avec un chiffon légèrement humide - n'utilisez pas de produits chimiques abrasifs ou d'eau de Javel.
- Ne laissez pas les enfants utiliser le mécanisme de levage.
- Ne laissez pas les enfants s'approcher de la base de levage lorsqu'ils actionnent le mécanisme.
- Ne vous tenez PAS à l'intérieur du lit ou de la base de stockage interne.
- Ne surchargez pas la base de stockage interne.
- Ne pas sauter sur le produit ou l'une de ses parties.

- Posizionare il materasso sopra la struttura del letto.
- Non tirare le maniglie della cinghia.
- Premere con forza per rilasciare il gas compresso.
- Controllare periodicamente tutte le viti e i fissaggi per assicurarsi che siano saldi.
- Quando si sposta il prodotto, sollevarlo con cautela.
- Pulire con un panno leggermente umido, senza usare prodotti chimici abrasivi o candeggina.
- **NON** permettere ai bambini di azionare il meccanismo di sollevamento.
- **NON** permettere ai bambini di avvicinarsi alla base di sollevamento quando si aziona il meccanismo.
- **NON** sostare all'interno del letto o della base di contenimento interna.
- **NON** sovraccaricare la base di contenimento interna.
- **NON** saltare sul prodotto o sulle sue parti.



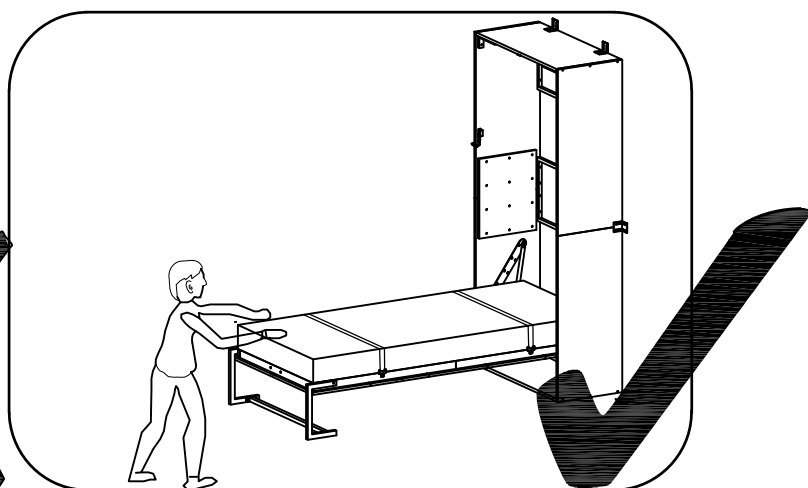
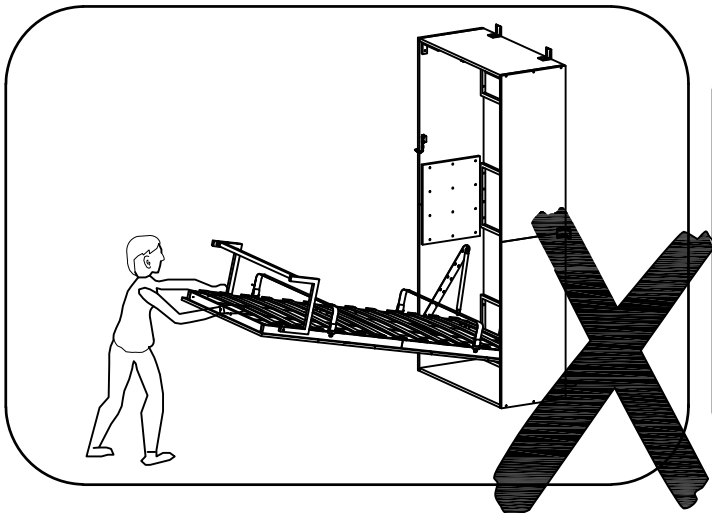

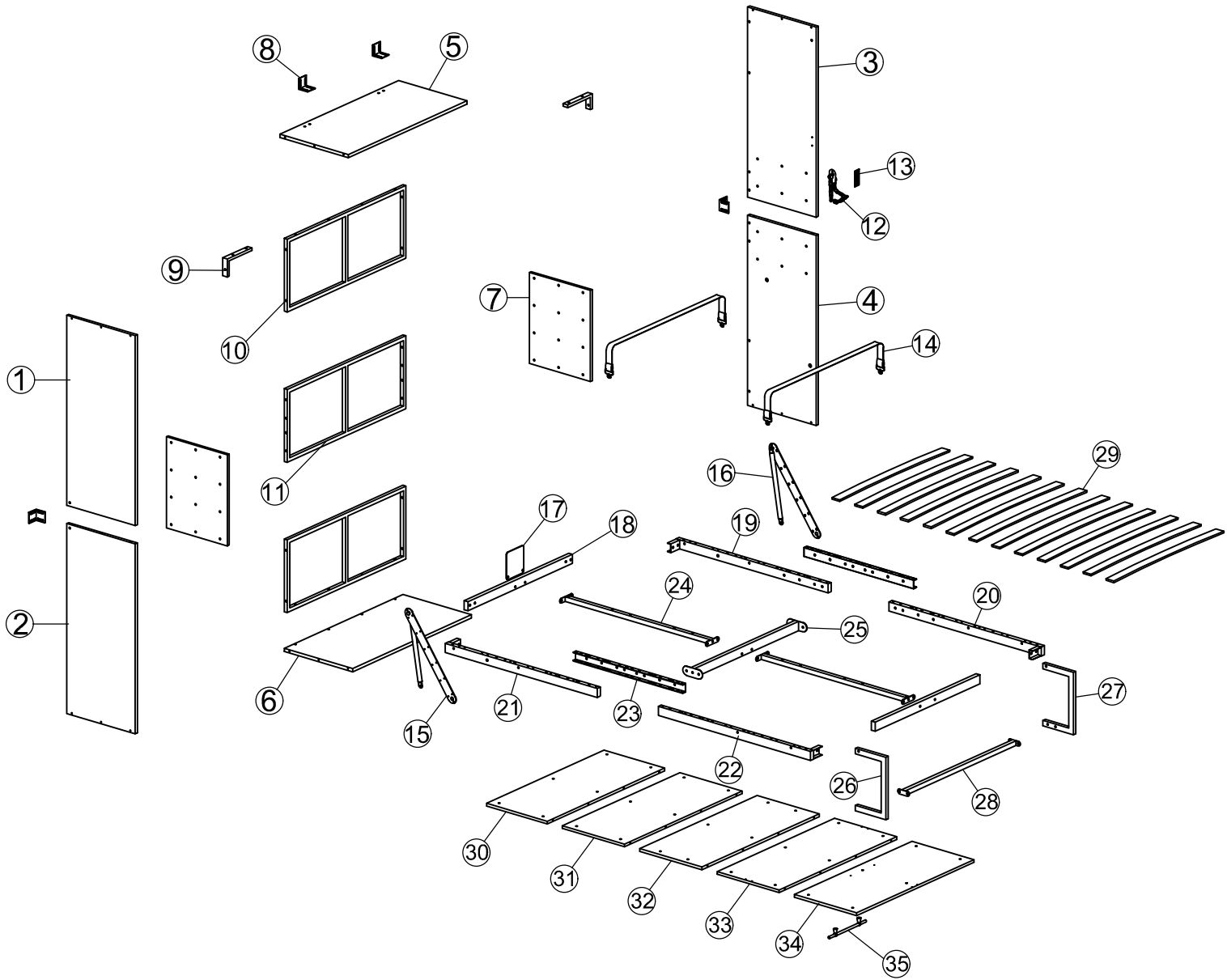
- Coloque el colchón sobre el somier.
- No tire de las asas de la correa.
- Presione con fuerza para liberar el gas comprimido.
- Compruebe periódicamente que todos los tornillos y fijaciones estén bien sujetos.
- Al mover el producto, levántelo con cuidado para colocarlo en su sitio.
- Limpie con un paño ligeramente humedecido; no utilice productos químicos abrasivos ni lejía.
- **NO** permita que los niños accionen el mecanismo de elevación.
- **NO** permita que los niños se acerquen a la base elevadora cuando accionen el mecanismo.
- **NO** se ponga de pie dentro de la cama o de la base de almacenamiento interna.
- **NO** sobrecargue el somier.
- **NO** salte sobre el producto ni sobre ninguna de sus piezas.



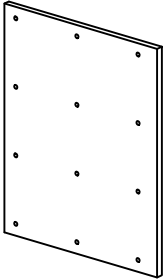
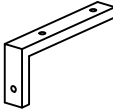
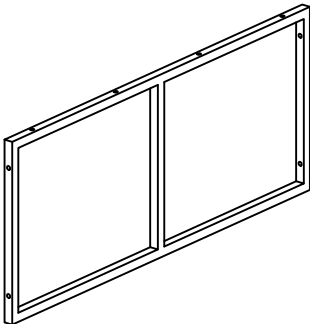
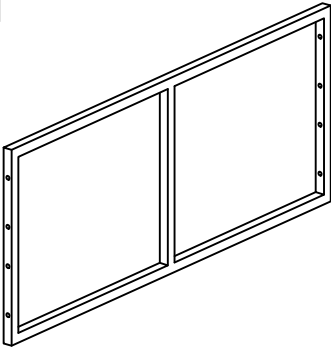

Part List-Teileliste-Liste des pièces

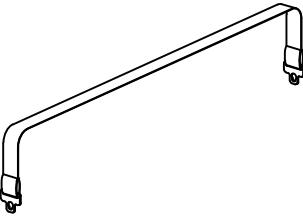
N623P433591

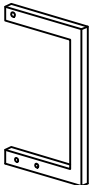
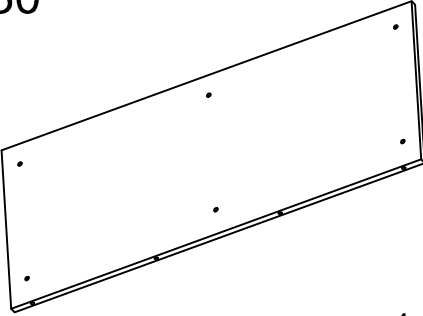
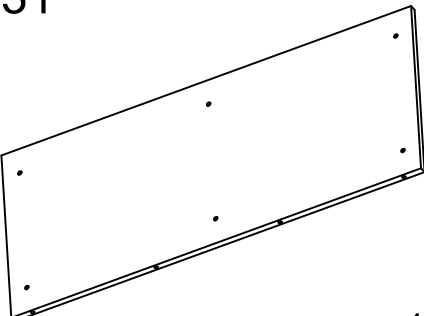
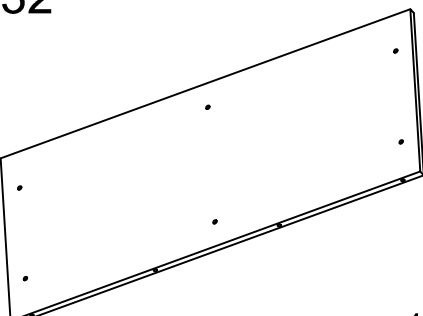
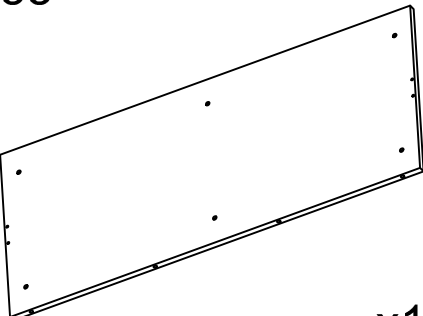
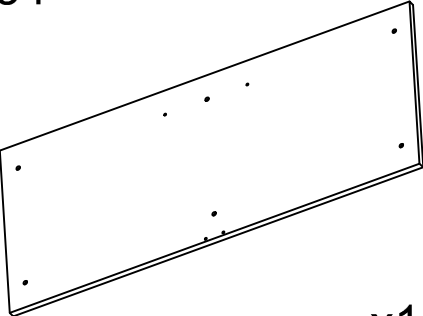
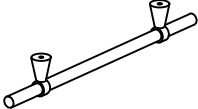
7  x2	9  x2	10  x2
11  x1	12  x1	13  x1
14  x2	26  x1	27  x1
30  x1	31  x1	32  x1
33  x1	34  x1	35  x1

Part List-Teileliste-Liste des pièces

N623P433592

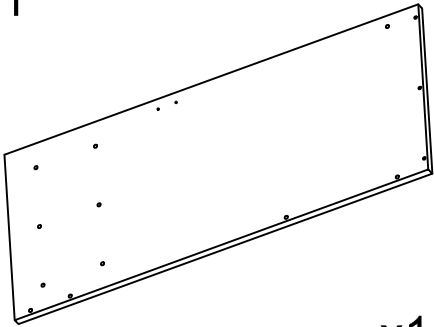
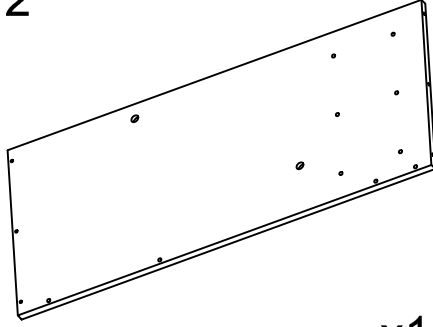
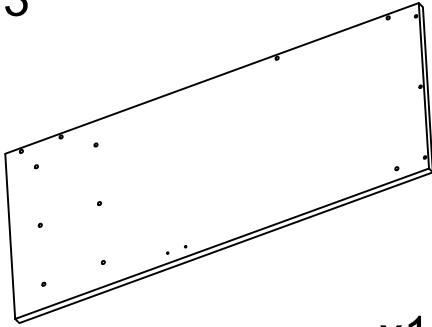
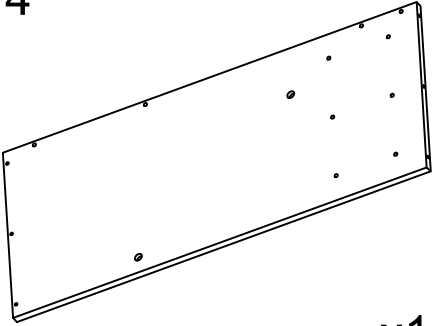
1  x1	2  x1	3  x1
4  x1		

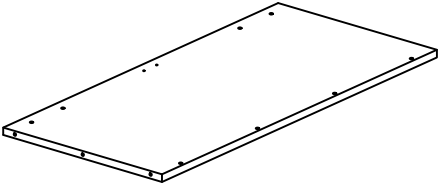
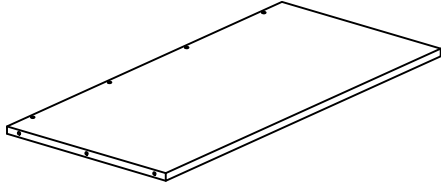
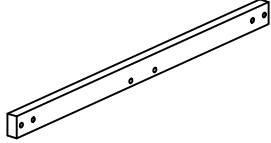
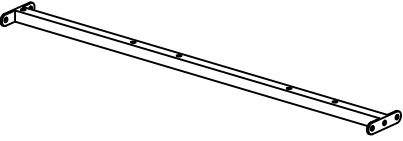
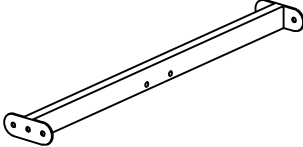
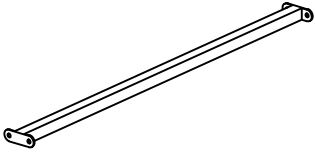
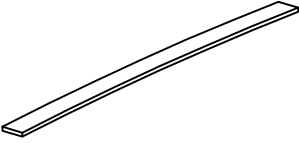

Part List-Teileliste-Liste des pièces

N623P433593

5  x1	6  x1	18  x2
24  x2	25  x1	28  x1
29  x13		



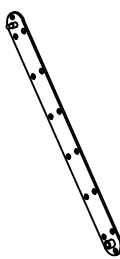

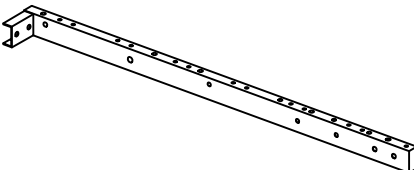
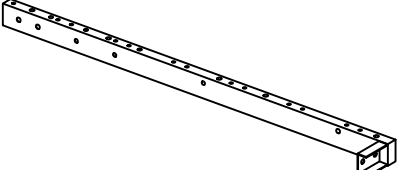
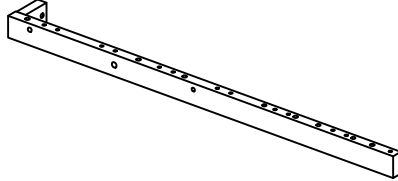
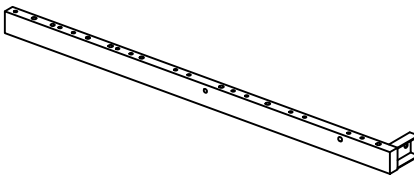
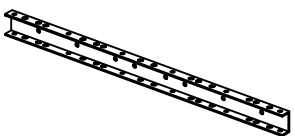











Part List-Teilleiste-Liste des pièces

















N623P433594







8  x4	15  x2	16  x2
17  x1	19  x1	20  x1
21  x1	22  x1	23  x2

Hardware List-Hardware-Liste-Liste du matériel

N623P433594

A		M6X10	X8
B		M6X20	X24
C		M6X25	X6
D		M6X30	X24
E		M6X60	X20
F		M8X15	X50
H		M8X35	X4
I		M8X65	X2
J		M6X16	X70
K		M8X18	X6
L		M6X35	X10
M		M8	X6
N1			X3
N2			X3
O		M3X20	X2
P		M4X14	X28



Q1		M3X12	X10
Q2		M3X14	X2
R		M3X12	X6
S		M7X38	X12
T		M6X30	X22
U1		M6	X1
U2		M8	X1
U3		M10	X1
V		M8	X1
W			X26
X1		M8X10	X2
X2		M10X12	X2
Y1		M8X35	X2
Y2		M10X40	X2
Z1			X4
Z2			X2

A		M6X10	X8
B		M6X20	X24
C		M6X25	X6
D		M6X30	X24
E		M6X60	X30
L		M6X35	X10

DE:Bitte beachten Sie, dass die Formen der Schrauben A und B und C und D und E und L ähnlich sind. Bitte installieren Sie entsprechend der Anleitung und unterscheiden Sie sie!

UK:Please note that the shapes of screws A and B and C and D and E and L are similar. Please install according to the instructions and distinguish them!

FR:Notez que les vis A et B et C et D et E et L ont des formes similaires. Veuillez les installer en suivant les instructions pour les séparer!

F		M8X15	X50
H		M8X35	X4
I		M8X65	X2

DE:Bitte beachten Sie, dass die Formen der Schrauben F und H und I ähnlich sind. Bitte installieren Sie entsprechend der Anleitung und unterscheiden Sie sie!

UK:Please note that the shapes of screws F and H and I are similar. Please install according to the instructions and distinguish them!

FR:Notez que les vis F et H et I ont des formes similaires. Veuillez les installer en suivant les instructions pour les séparer!

1

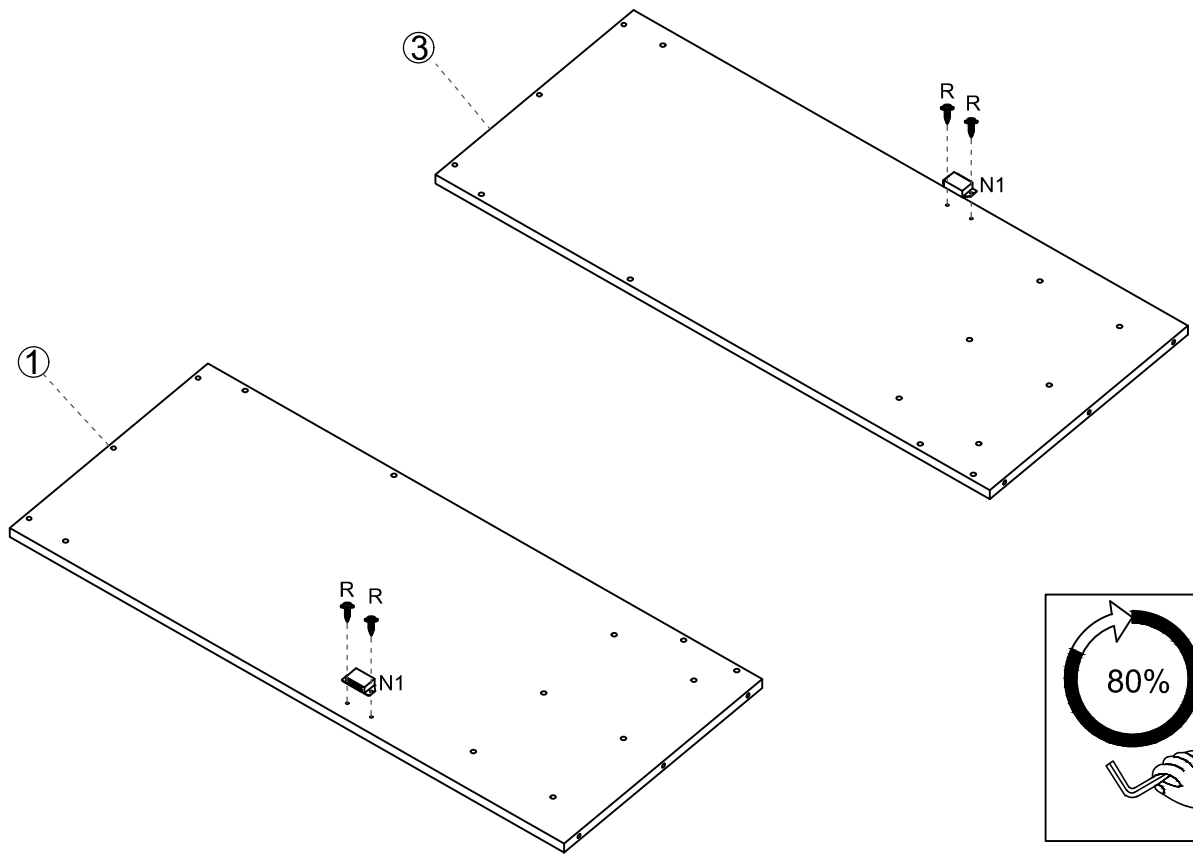

N1		X2
R	 M3X12	X4

2

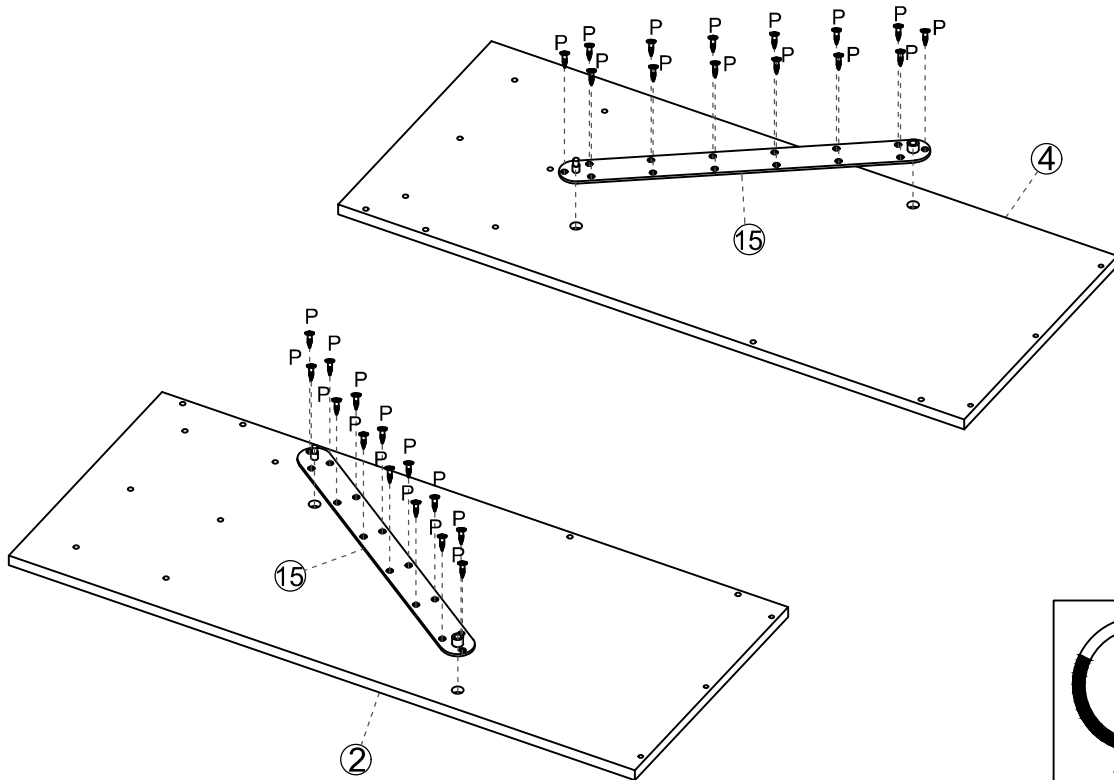

P	 M4X14	X28
---	---	-----

3

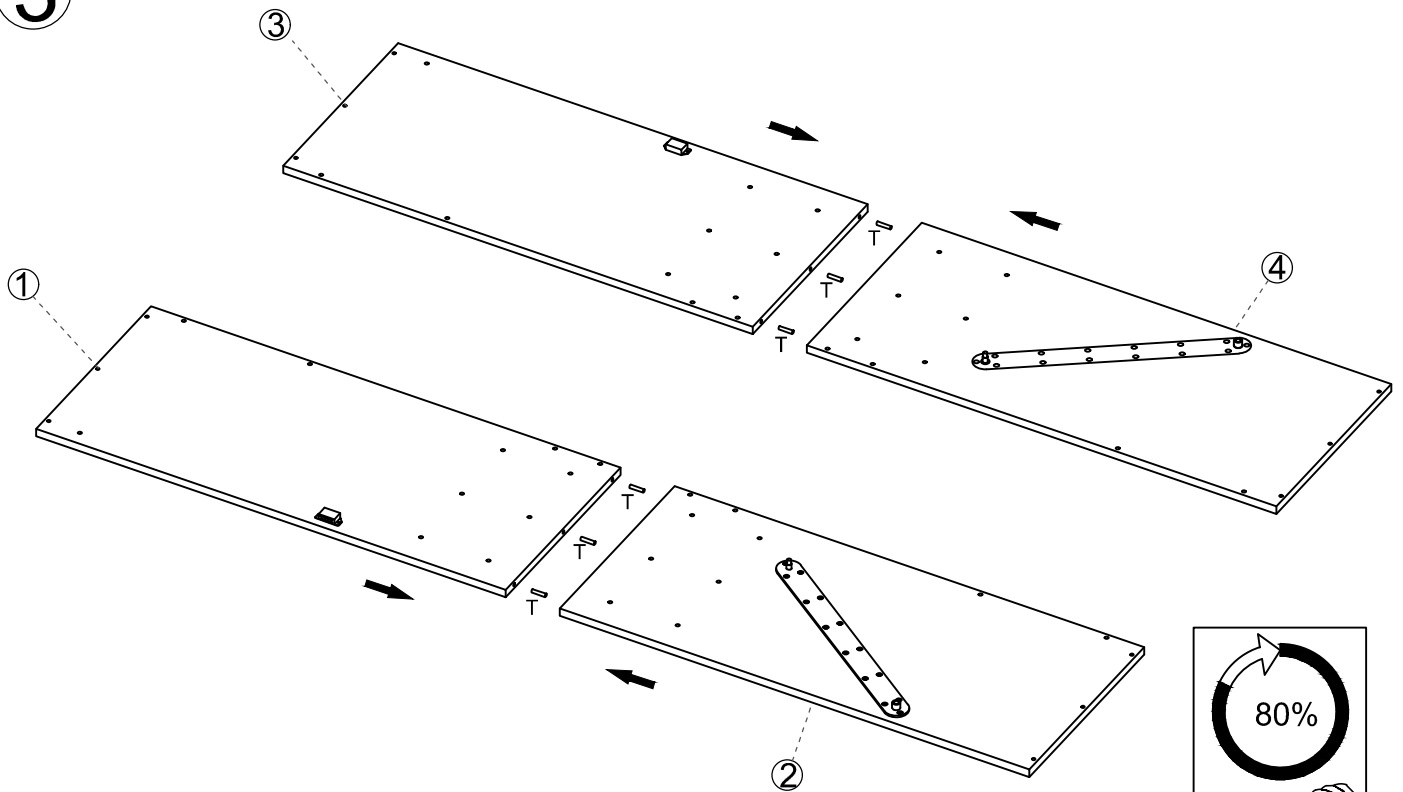

T  M6X30 X6

4

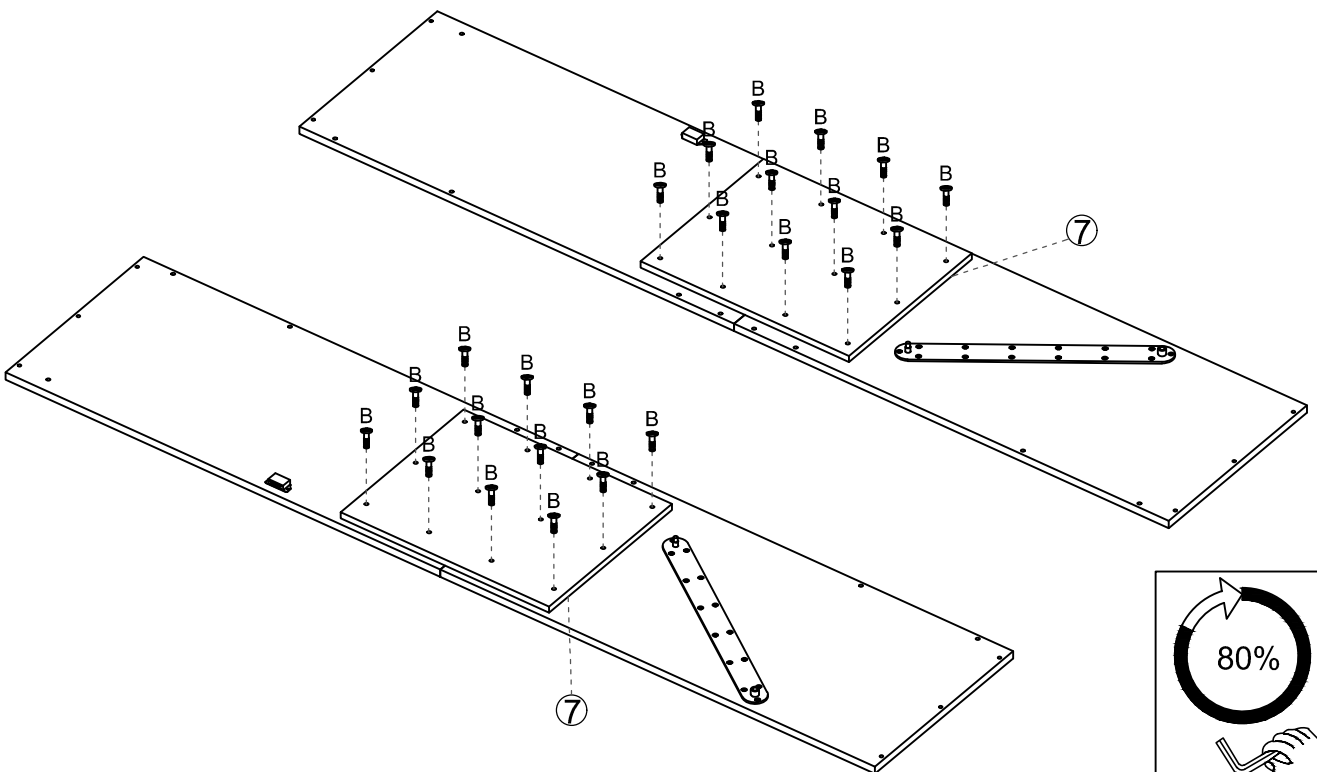

B  M6X20 X24

5

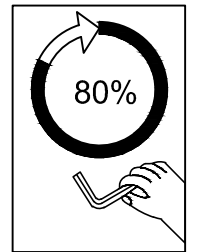
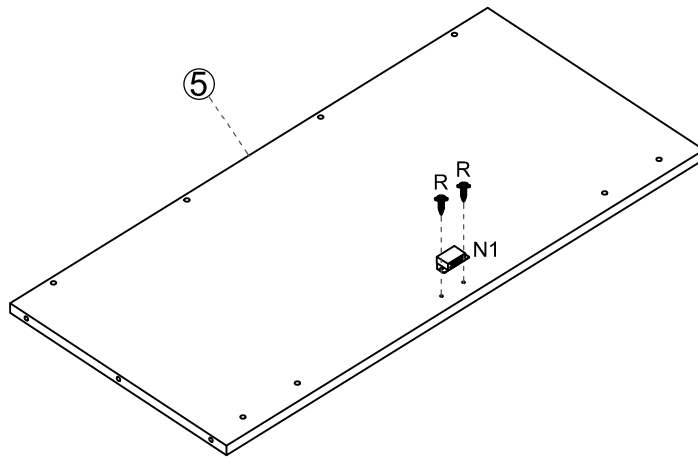

N1		X1
R	M3X12	X2

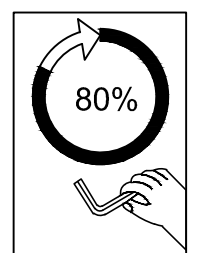
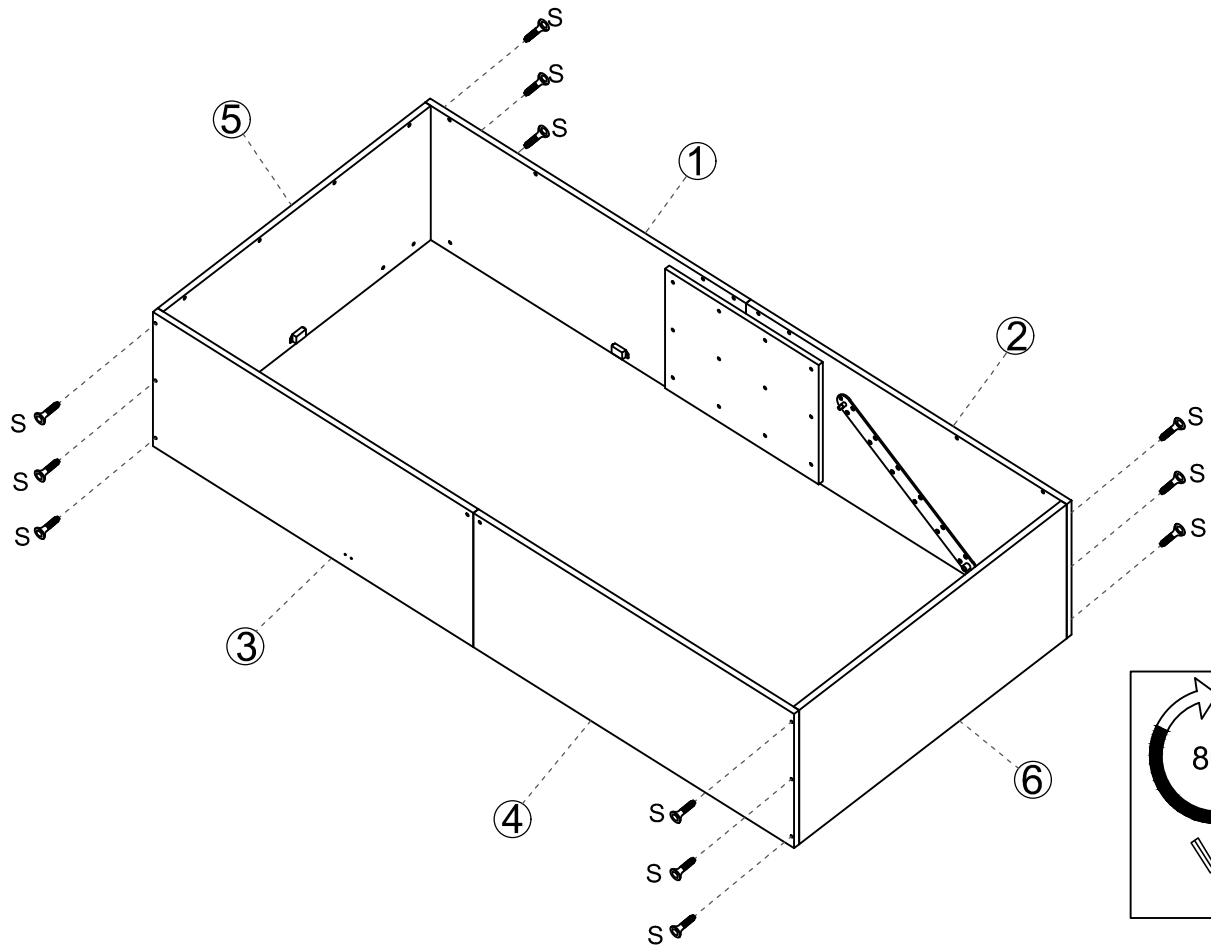

6

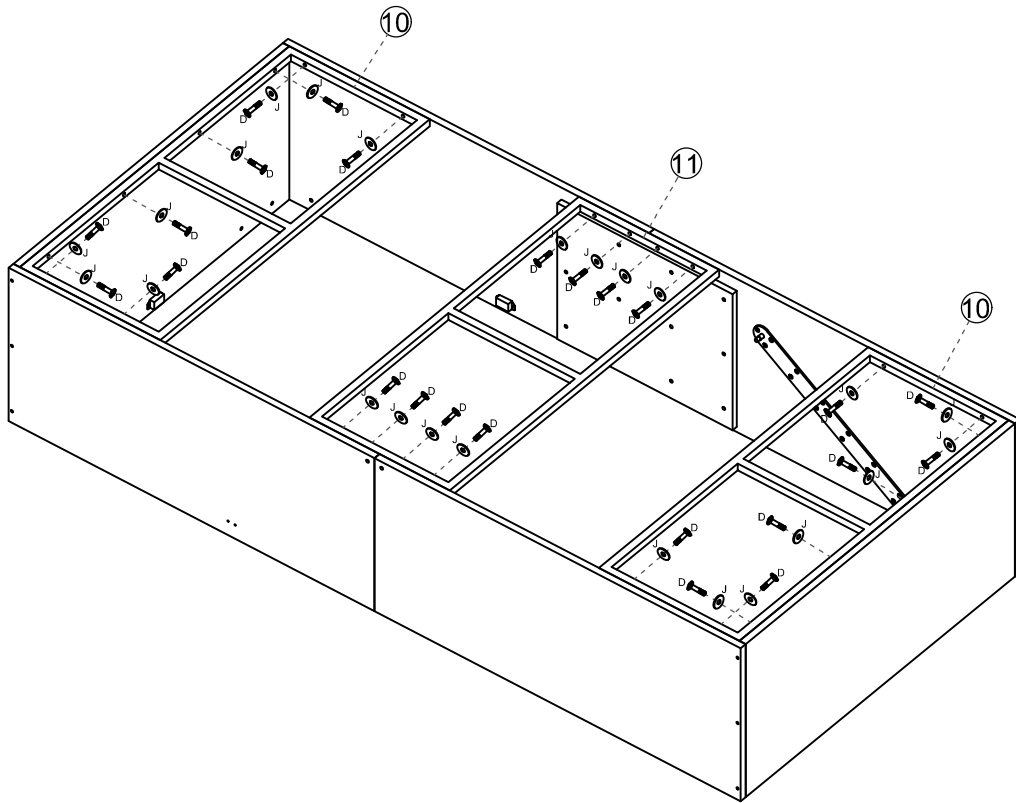

S	M7X38	X12
---	-------	-----

7



D		M6X30	X24
J		M6X16	X24

8

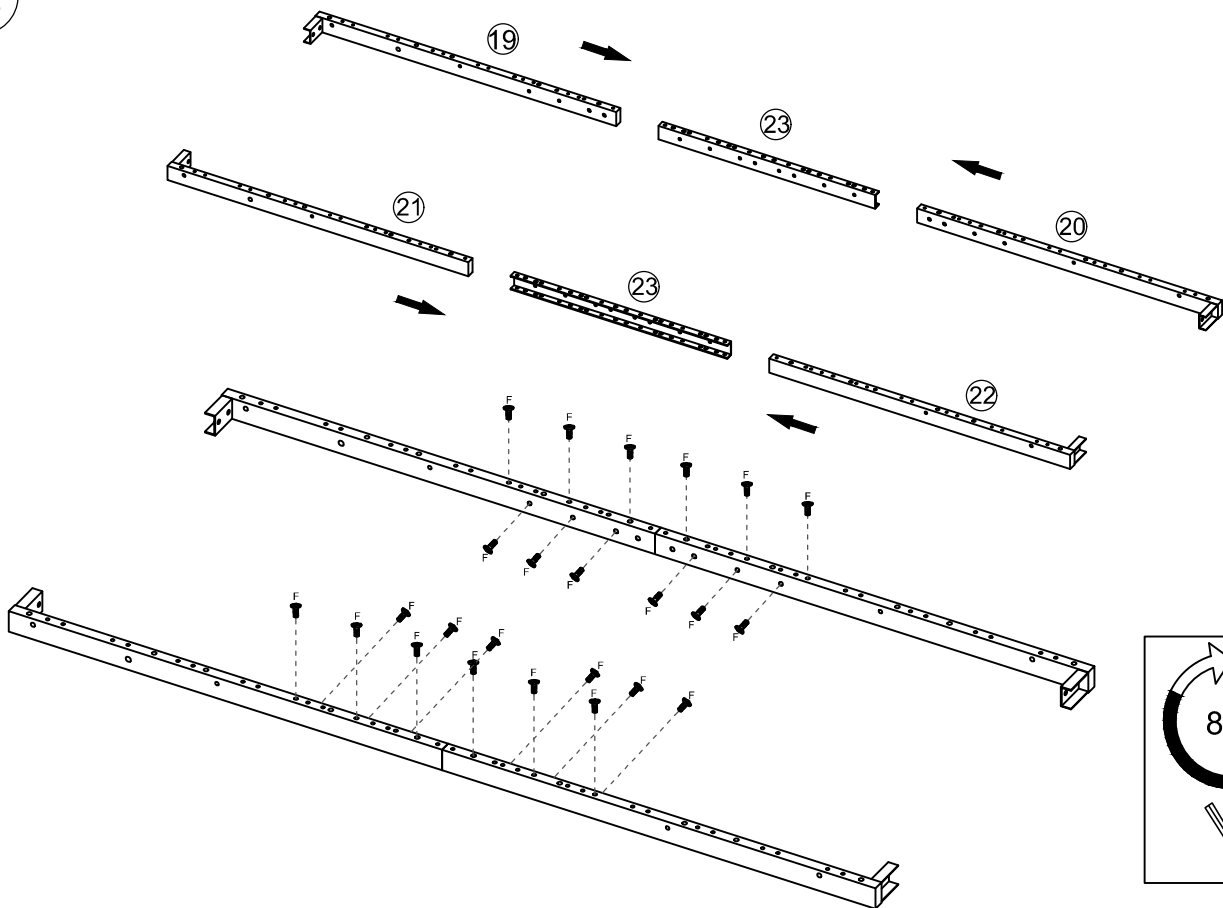

F		M8X15	X24
---	---	-------	-----

9

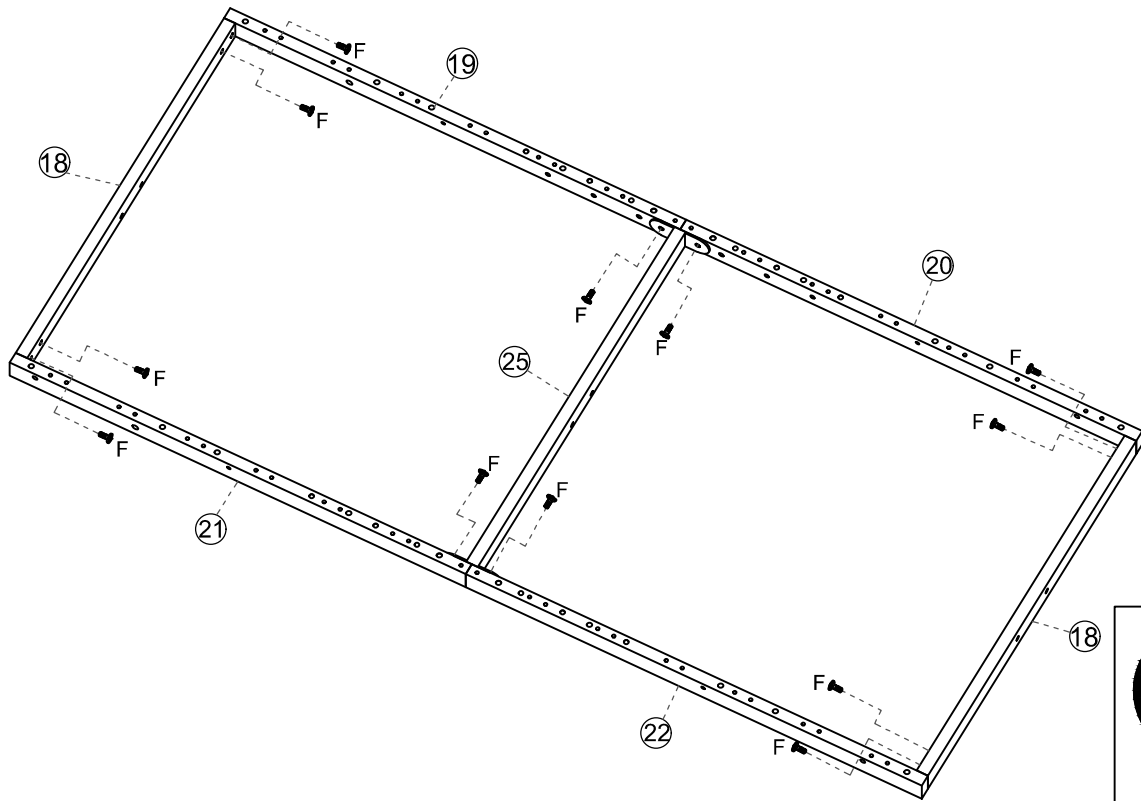

F  M8X15 X12

10

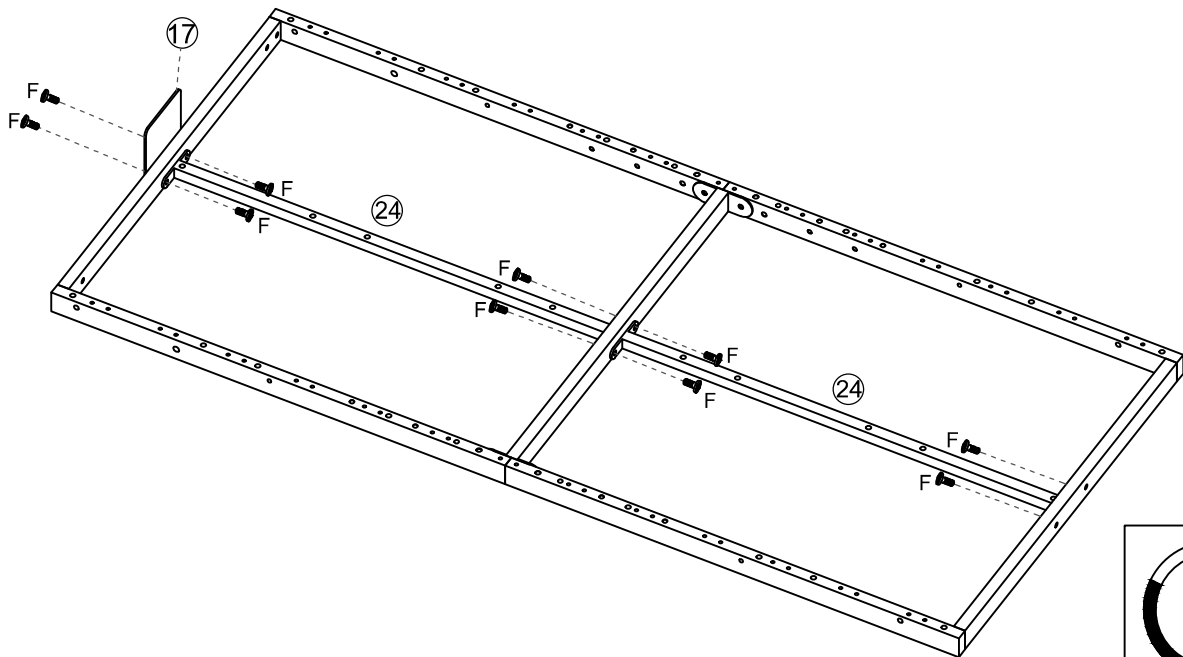

F  M8X15 X10

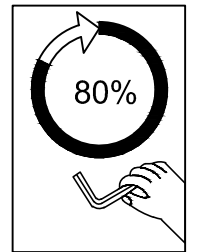
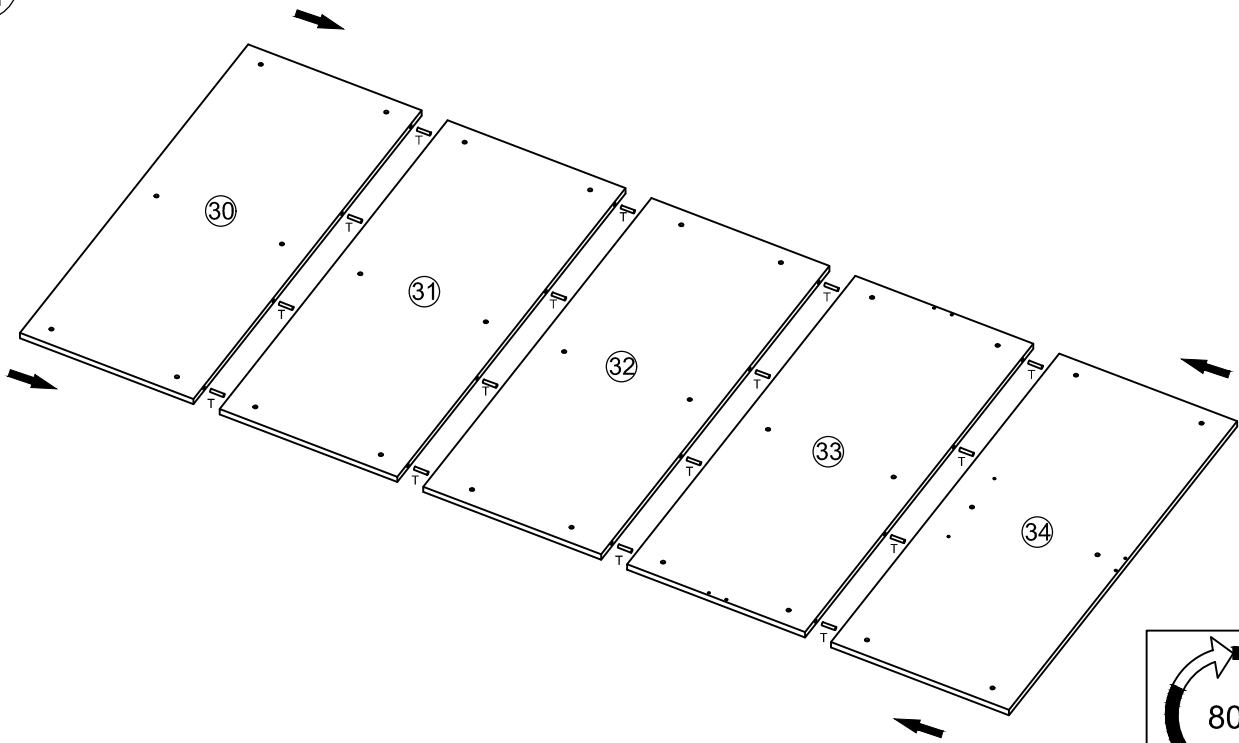

11



T		M6X30	X16
---	---	-------	-----

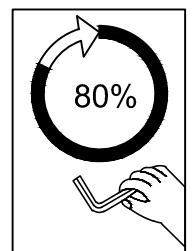
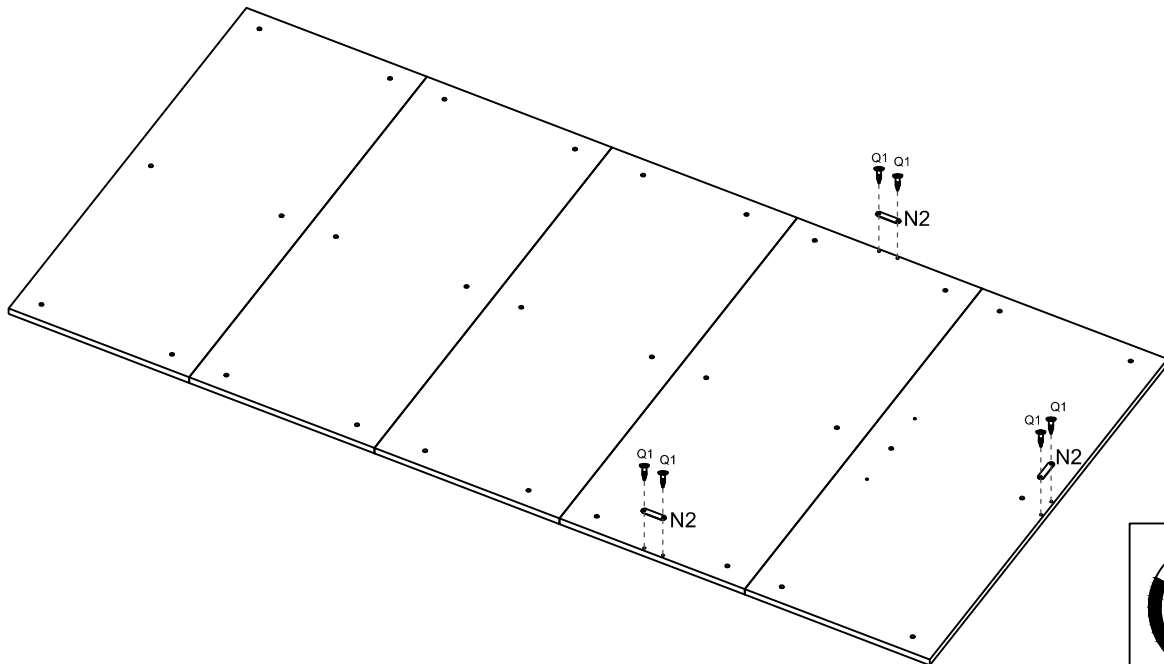

12



N2			X3
Q1		M3X12	X6

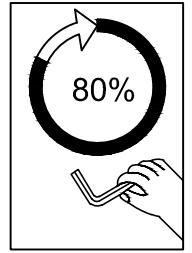
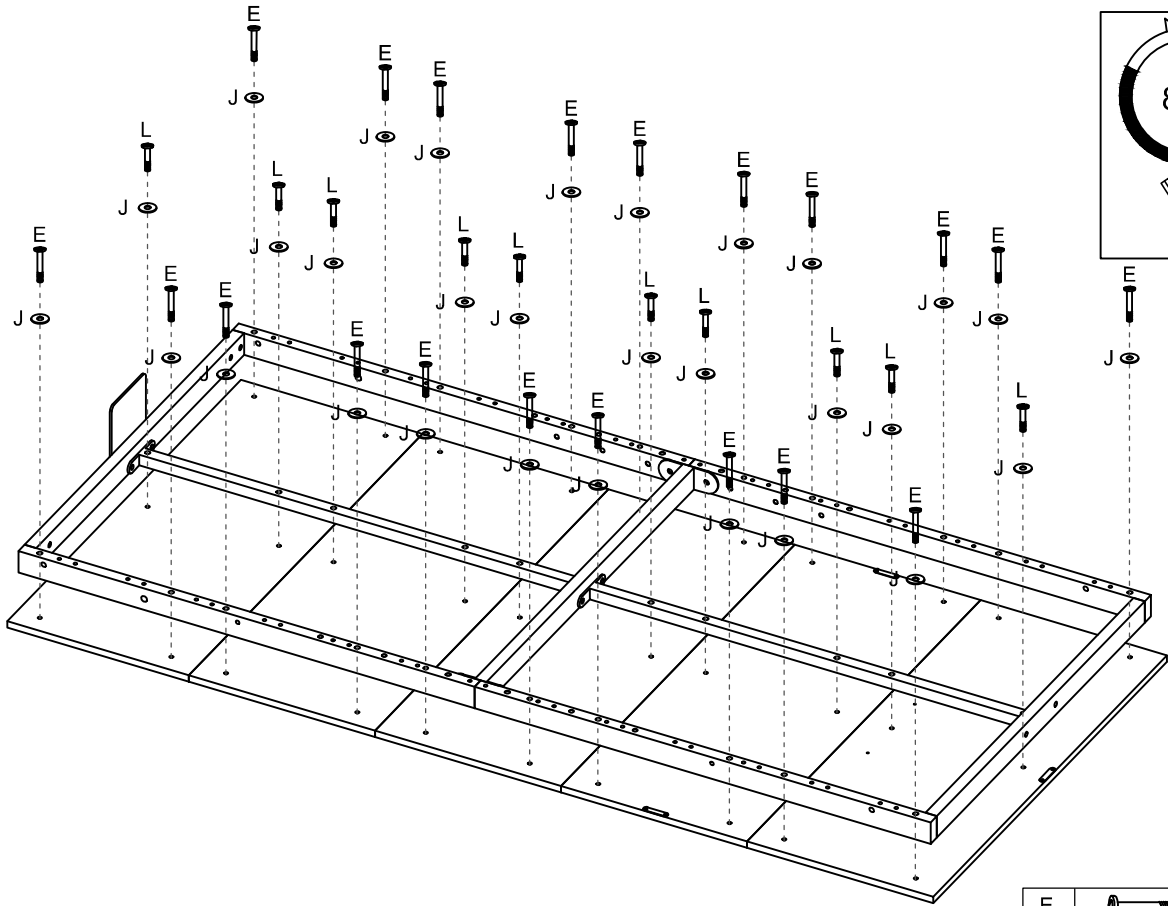

13



E		M6X60	X20
J		M6X16	X30
L		M6X35	X10

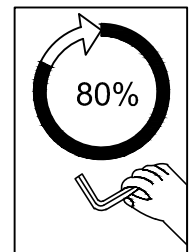
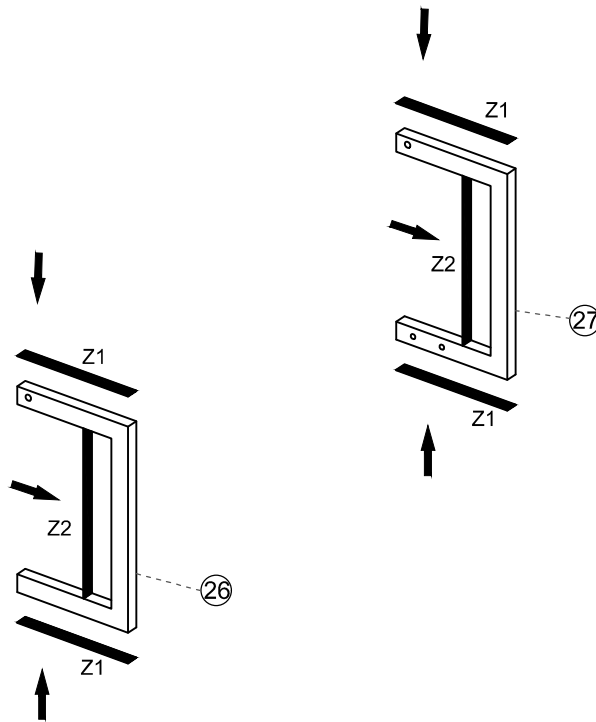

14

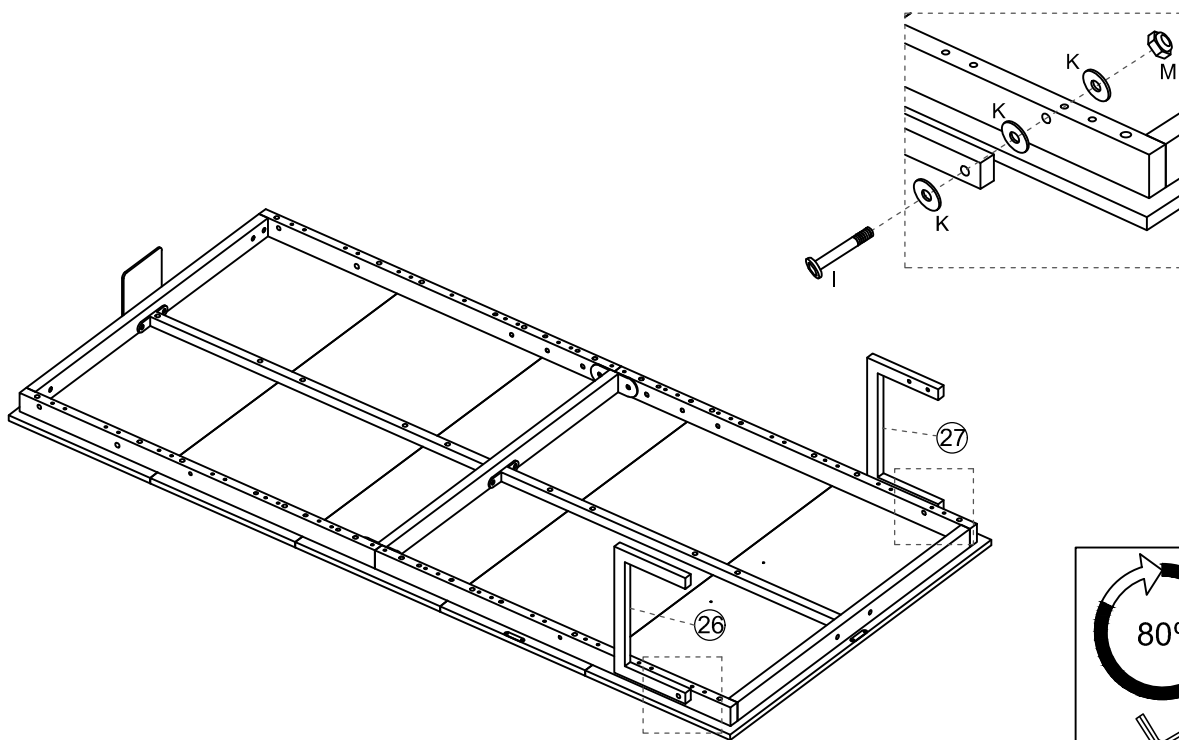

Z1		X4
Z2		X2

15



I		M8X65	X2
K		M8X18	X6
M		M8	X2

16

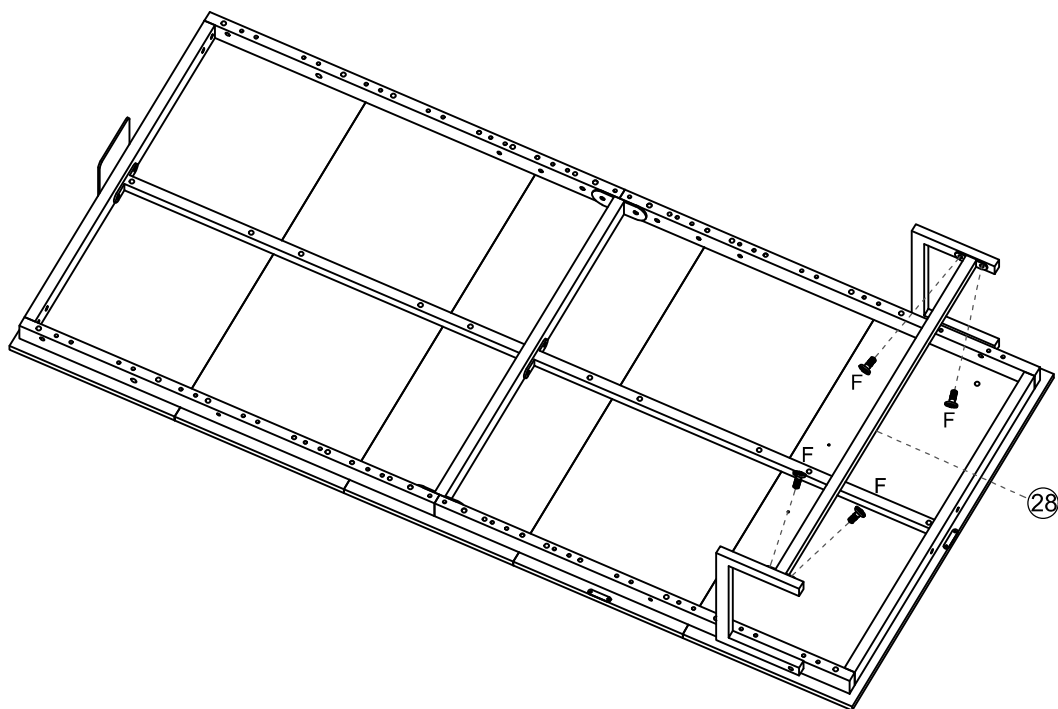

F		M8X15	X4
---	---	-------	----

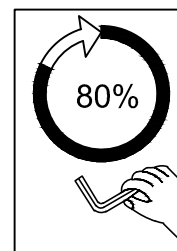
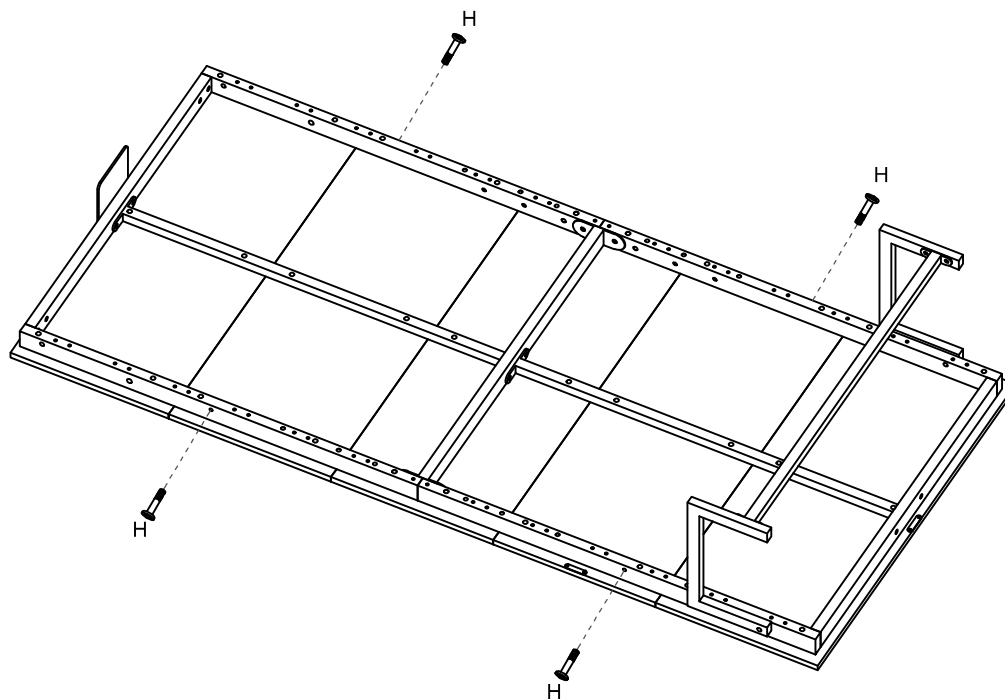

17

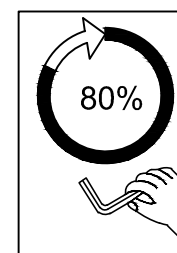
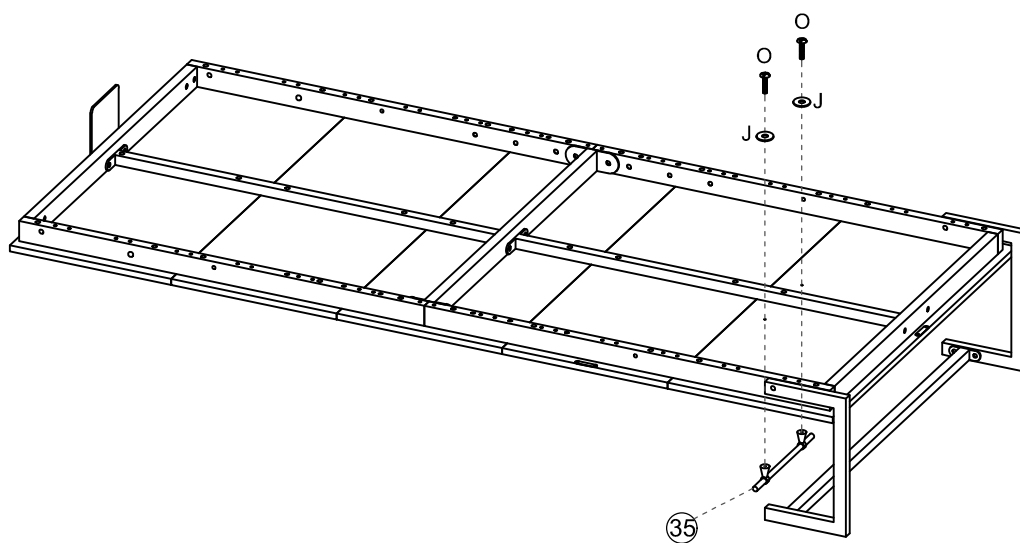

H		M8X35	X4
---	---	-------	----

18



J		M6X16	X2
O		M3X20	X2

19

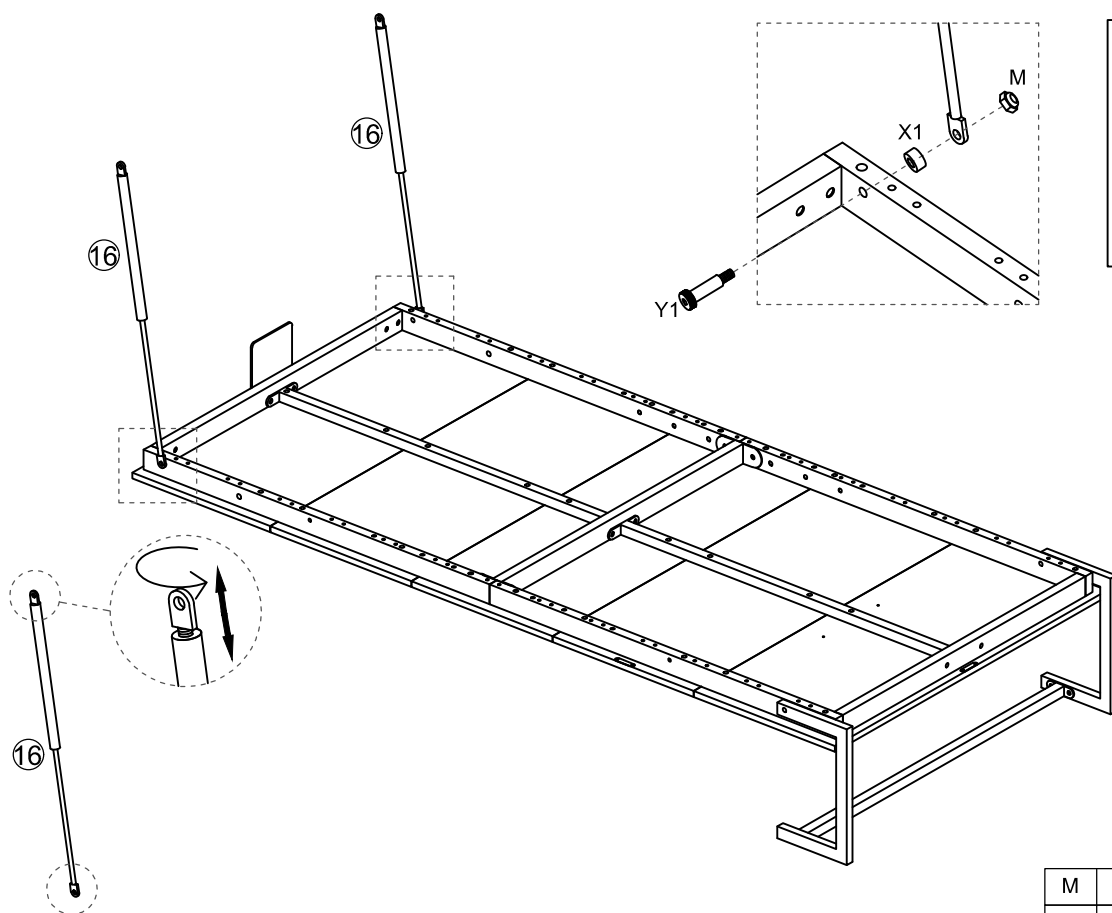

M		M8	X2
X1		M8X10	X2
Y1		M8X35	X2

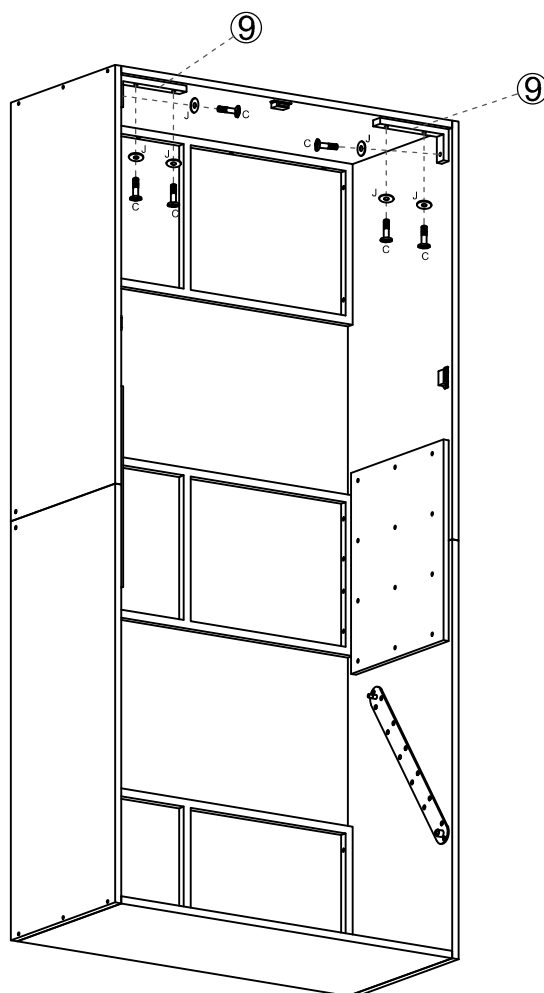

20

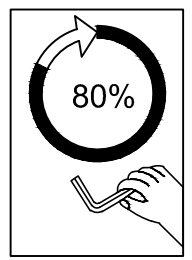
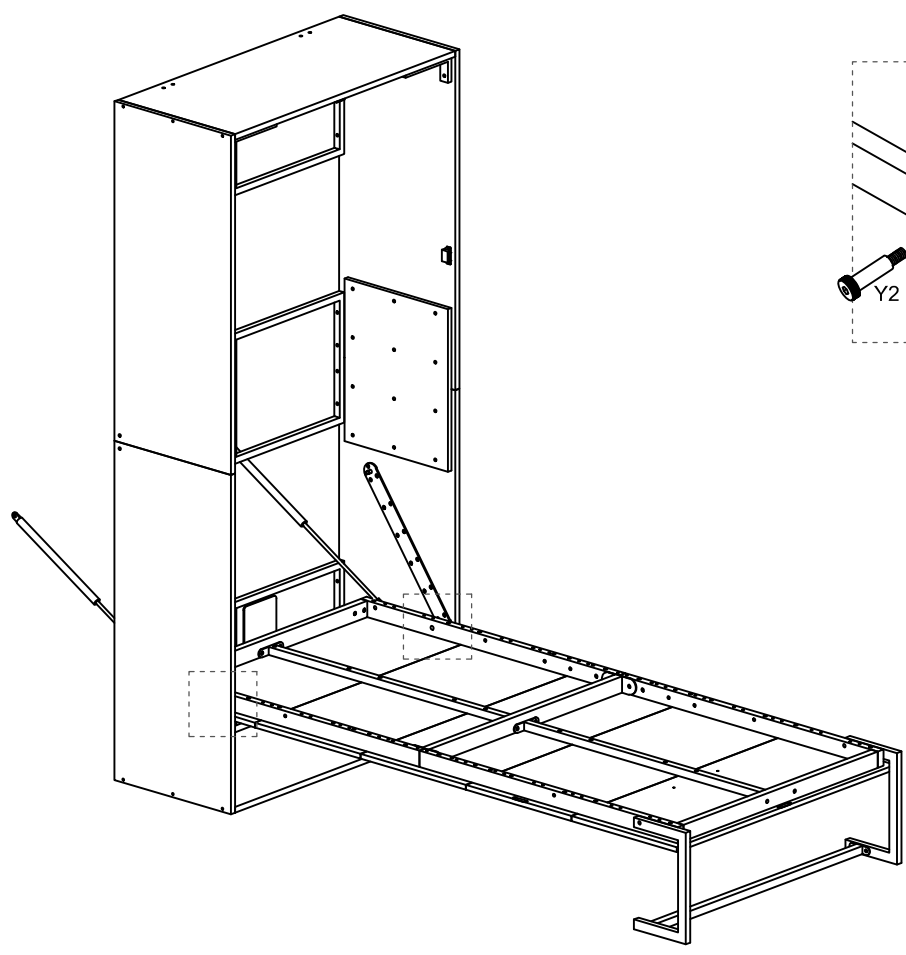

C		M6X25	X6
J		M6X16	X6

21



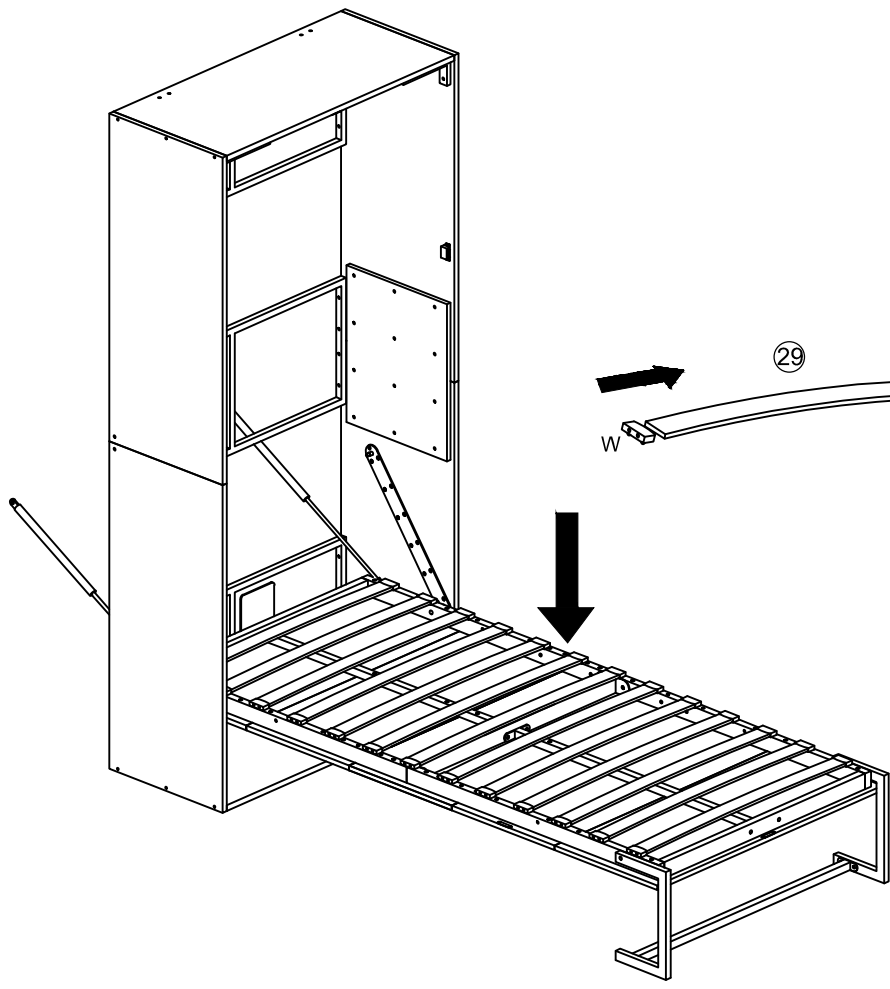

X2		M10X12	X2
Y2		M10X40	X2

22

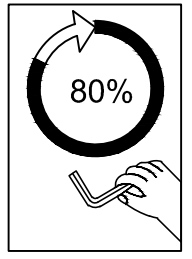

x13



W		X26
---	---	-----

23

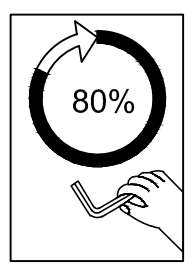
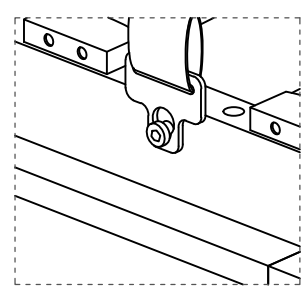
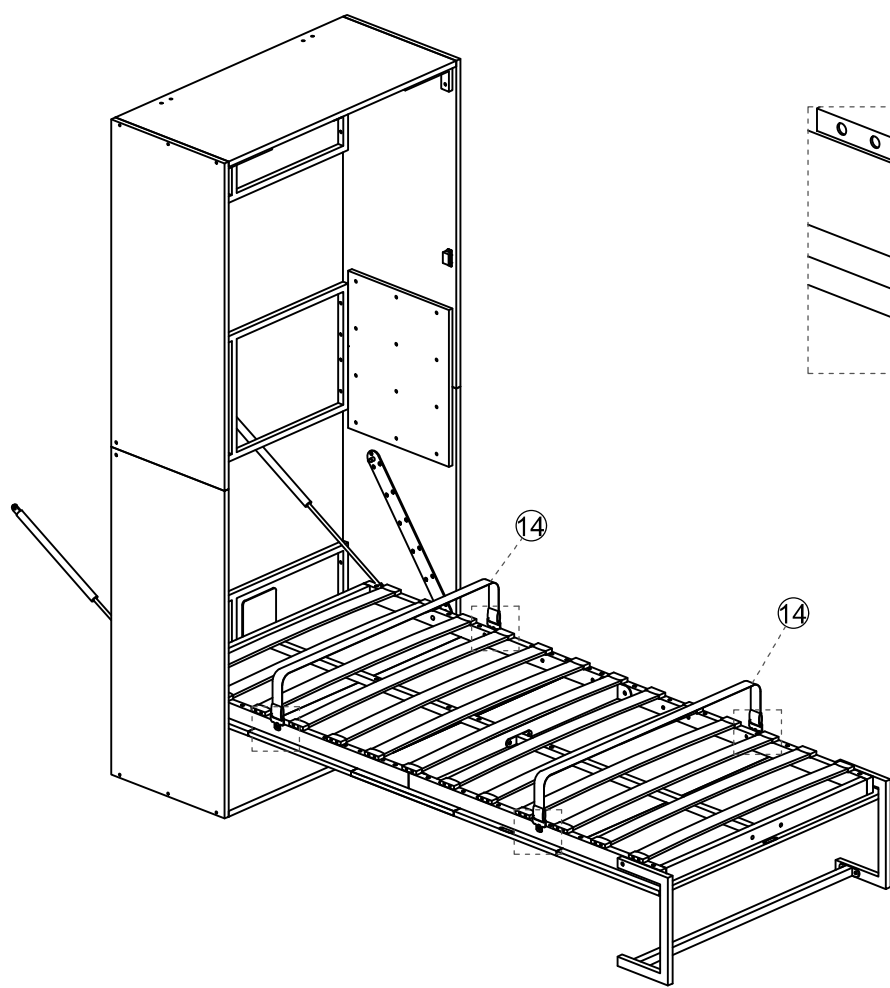

24

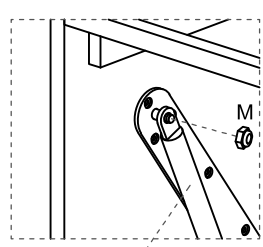
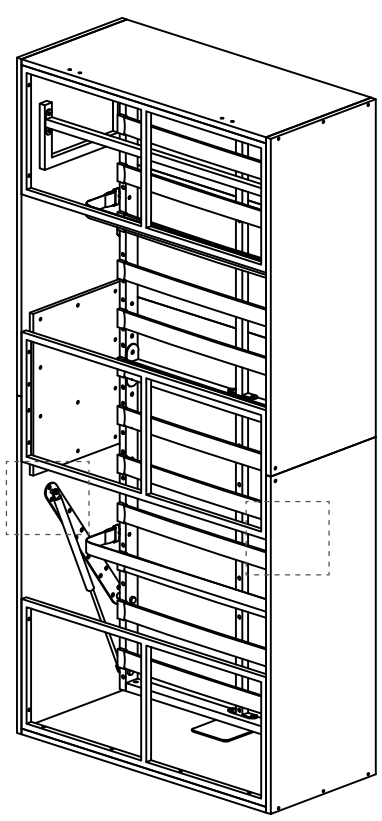

16

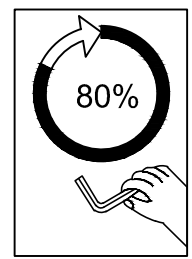

M Ⓜ M8 X2

25

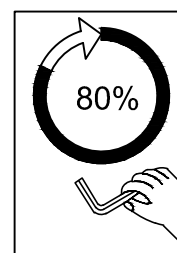
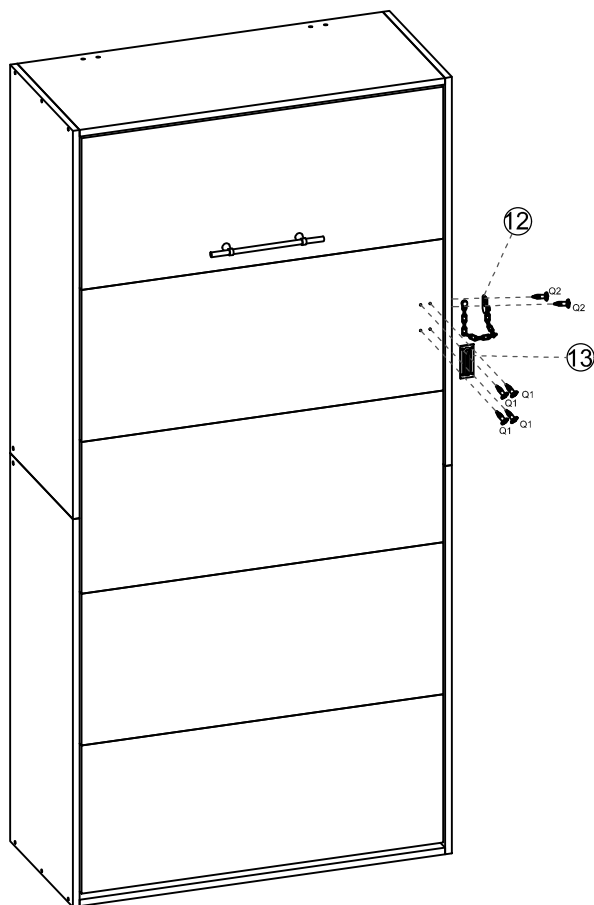

Q1		M3X12	X4
Q2		M3X14	X2

26

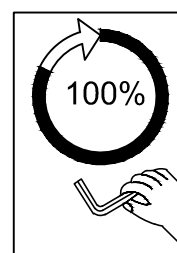
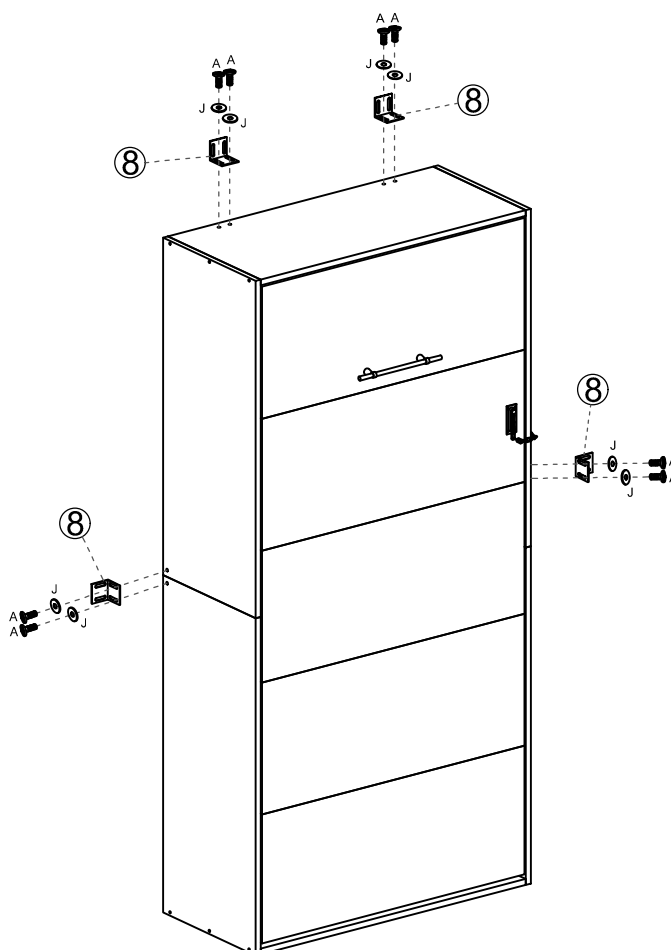

A		M6X10	X8
J		M6X16	X8

27

