

STEELSON

Gartenliege 'Solaria'

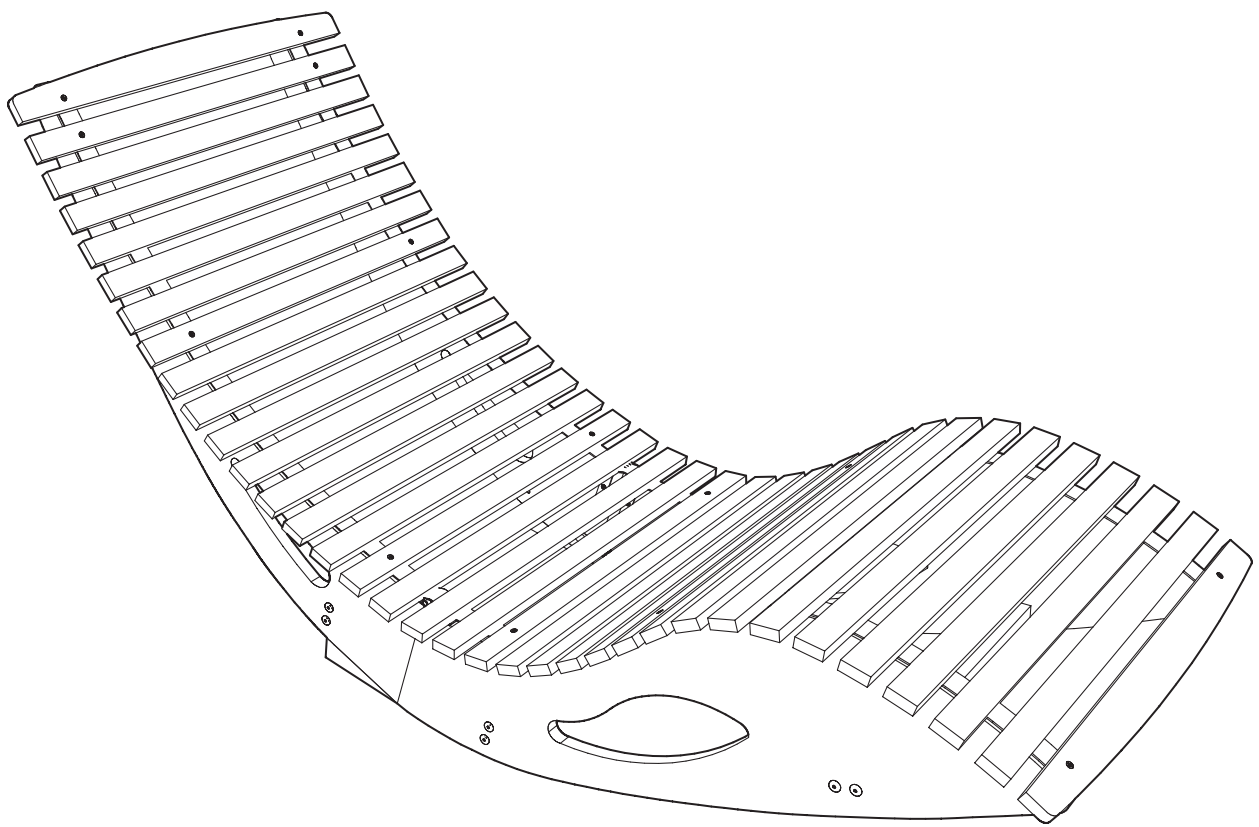



Hey,

wir freuen uns, dass Du Dich für unser Produkt entschieden hast. Beachte die kommenden Hinweise, um den Aufbau problemlos zu gestalten.

Viel Spaß mit Deinem Produkt!

50%

weniger Fehler beim Aufbau durch sorgfältiges Lesen der Anleitung



30-45

min

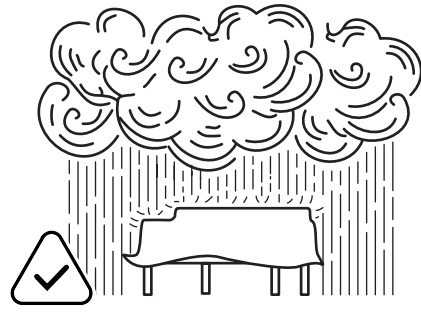
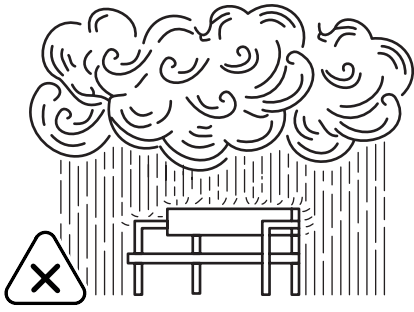

Um die Lebensdauer des Produkts zu verlängern,
schütze es vor Regen und Sonneneinstrahlung.

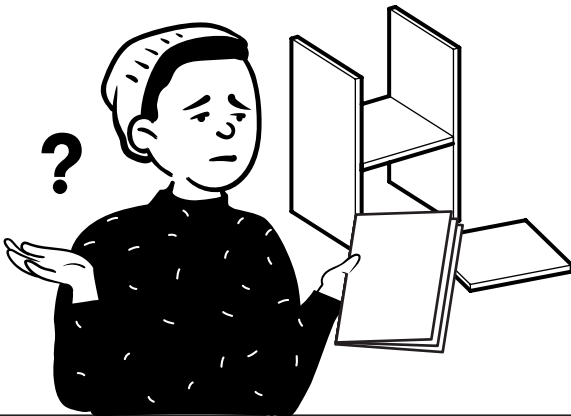

Fragen?

Wir sind für Dich da!

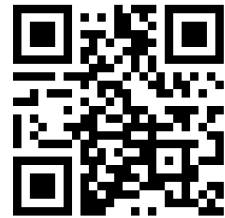

✉ service@bela-living.de

1.

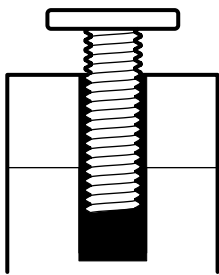

Ziehe die Schrauben während
des gesamten Aufbaus
zunächst per Hand an.

2.

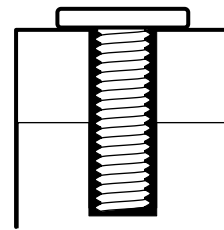

Justiere das Produkt final
und ziehe die Schrauben
vollständig an.

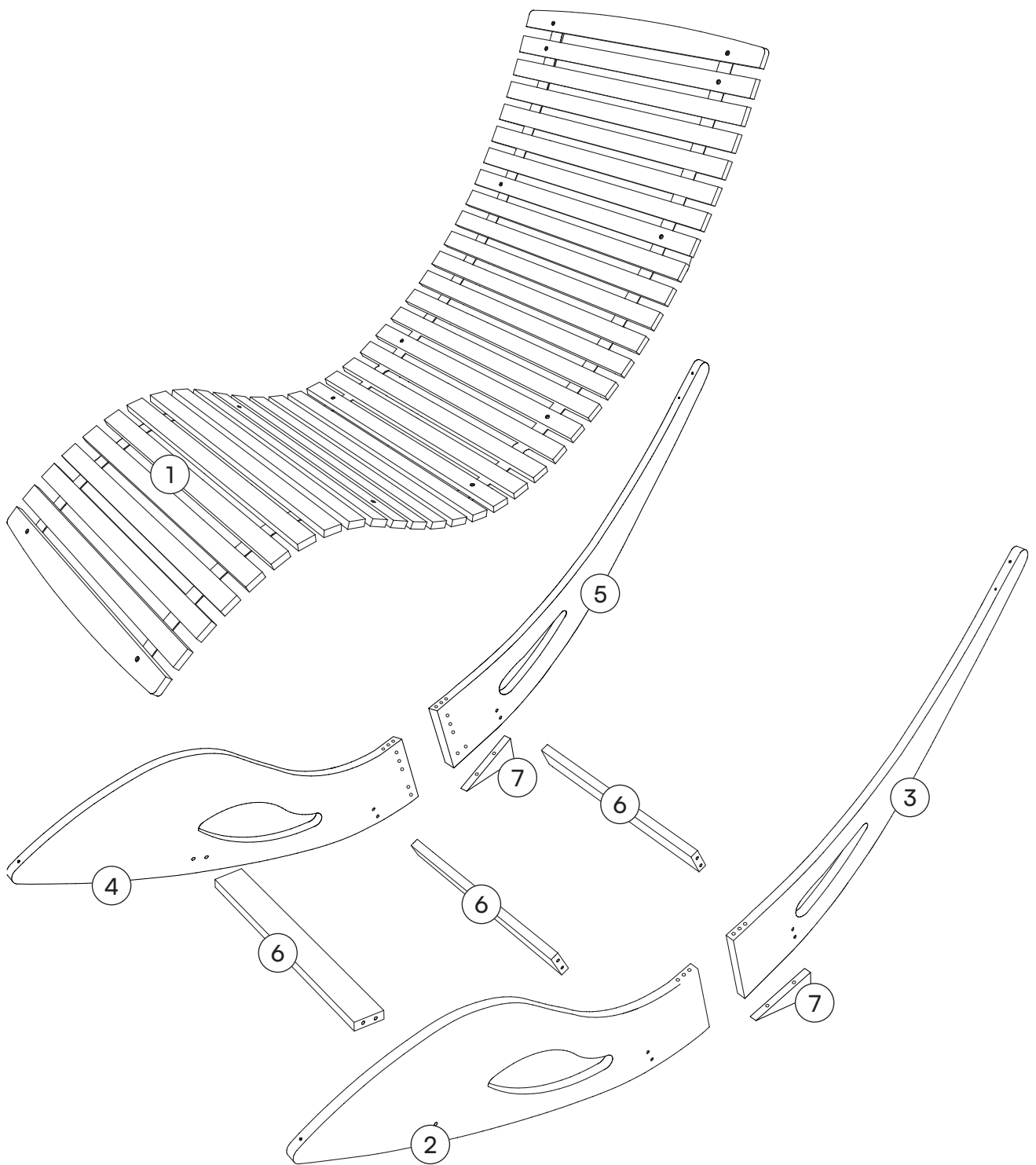

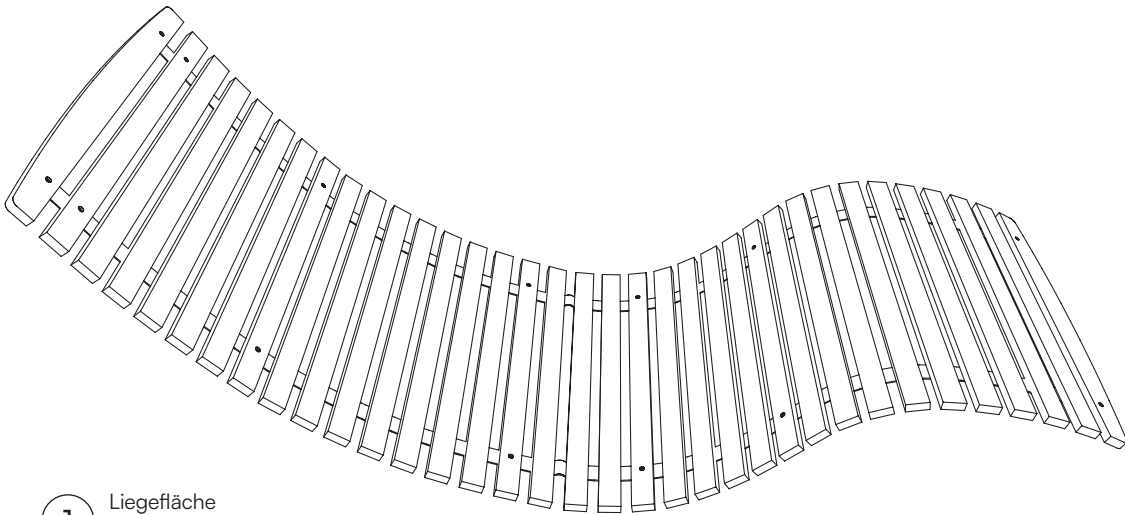

1 Liegefläche
1x

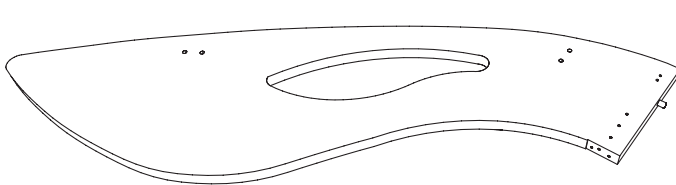

2 Seitenteil Sitz, rechts
1x

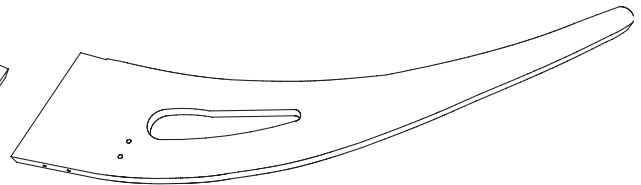

3 Seitenteil Lehne, rechts
1x

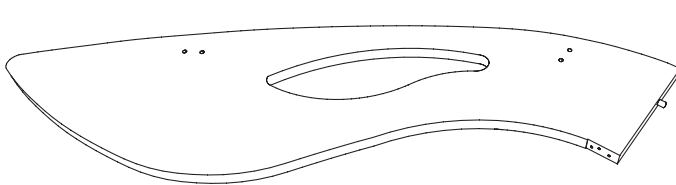

4 Seitenteil Sitz, links
1x

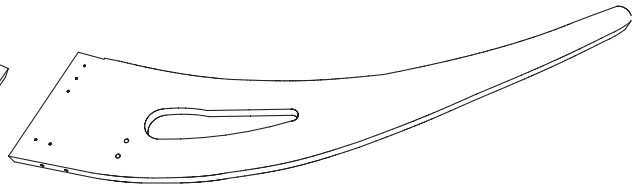

5 Seitenteil Lehne, links
1x



6 Querstrebe
3x

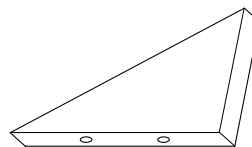

7 Kippschutz
2x



W65 - Schraube 6 x 50

12x



W41 - Schraube 4 x 35

18x

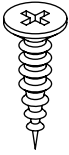

W26 - Schraube 4 x 20

12x



W102 - Schraube 4 x 15

20x

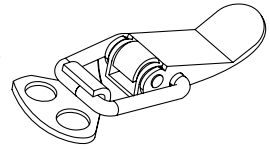

H50 - Spannverschluss

2x

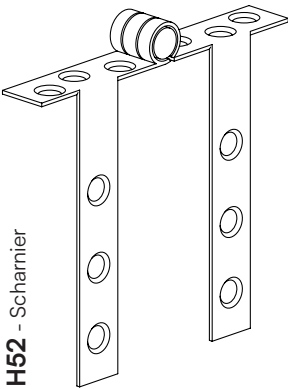

H52 - Scharnier

2x

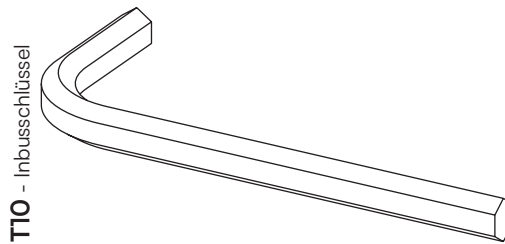

T10 - Inbusschlüssel

1x

Ein letzter Check:

Bitte überprüfe, ob Du alle Teile hast.

Viel Spaß beim Aufbau!

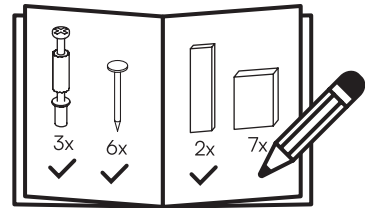

1

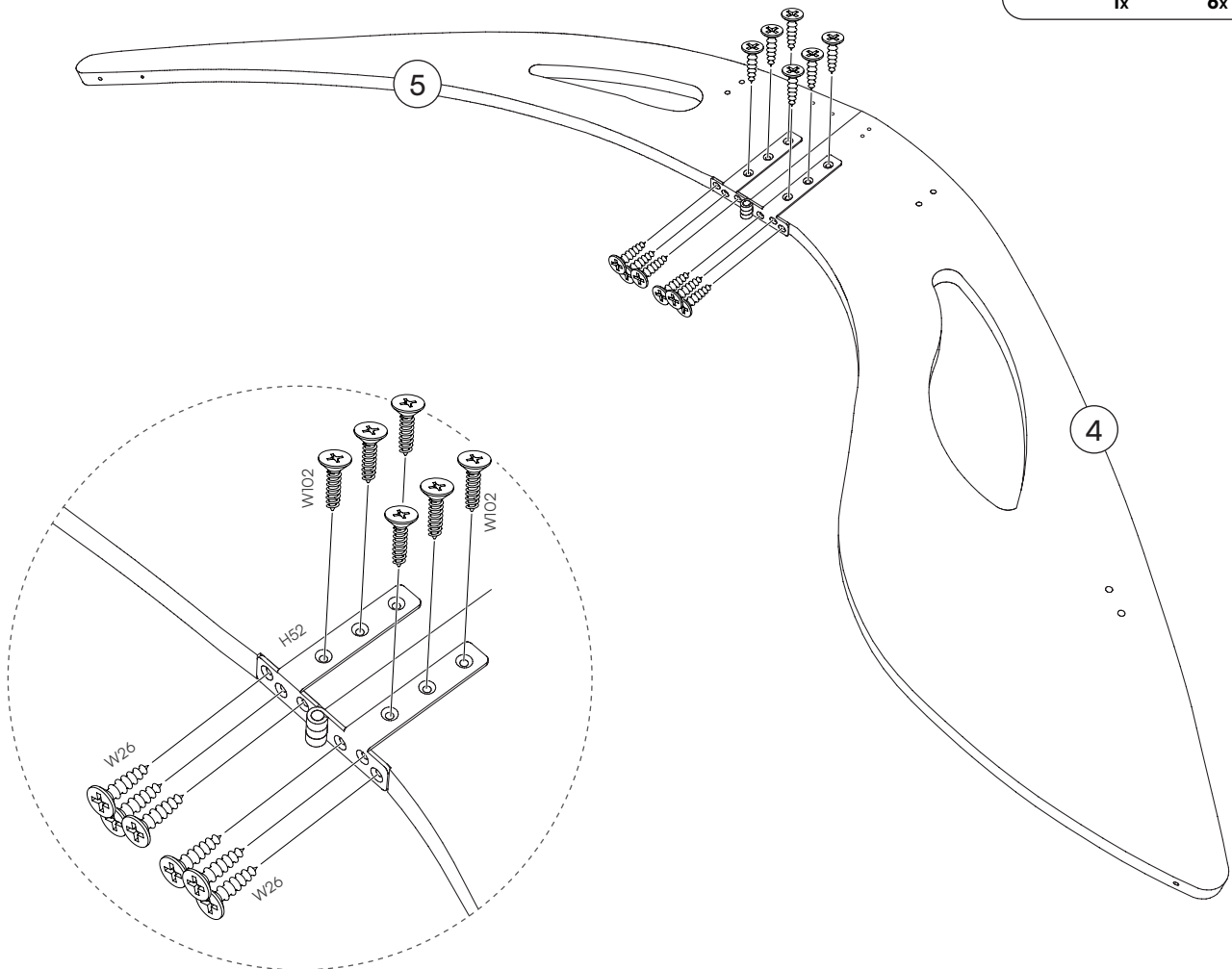
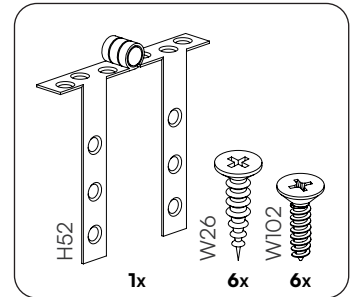

2

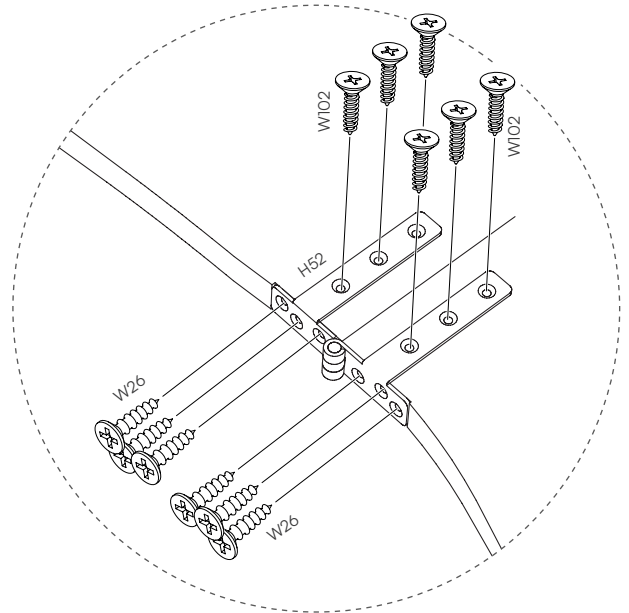
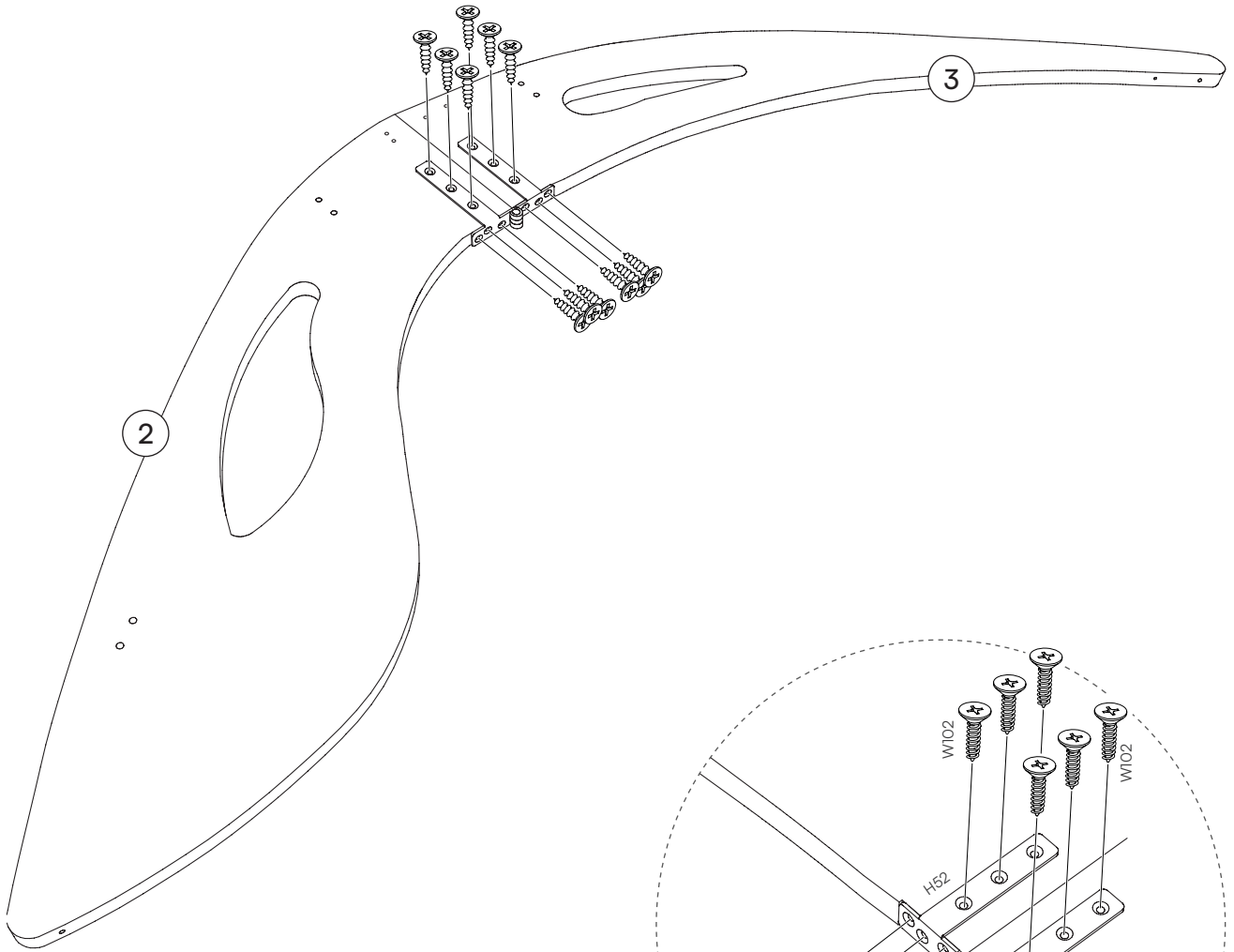
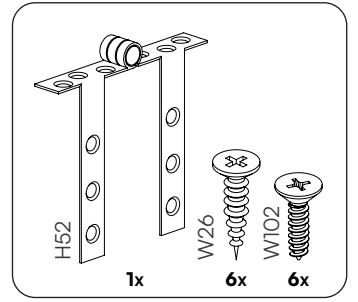

3

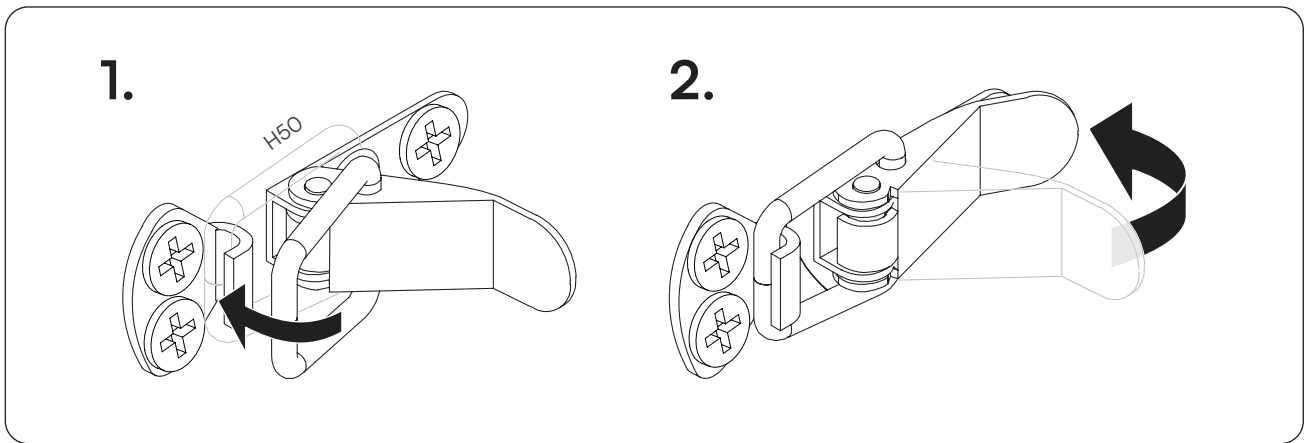
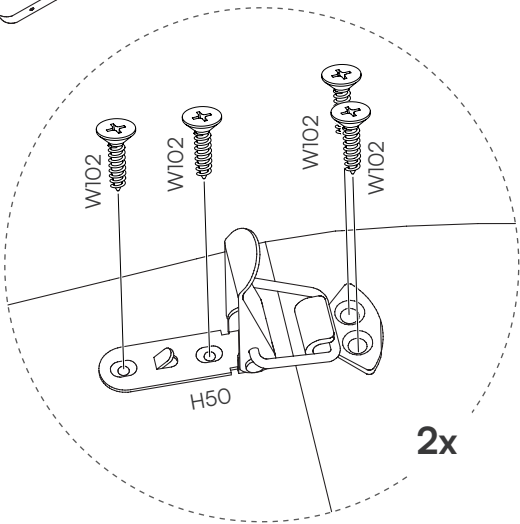
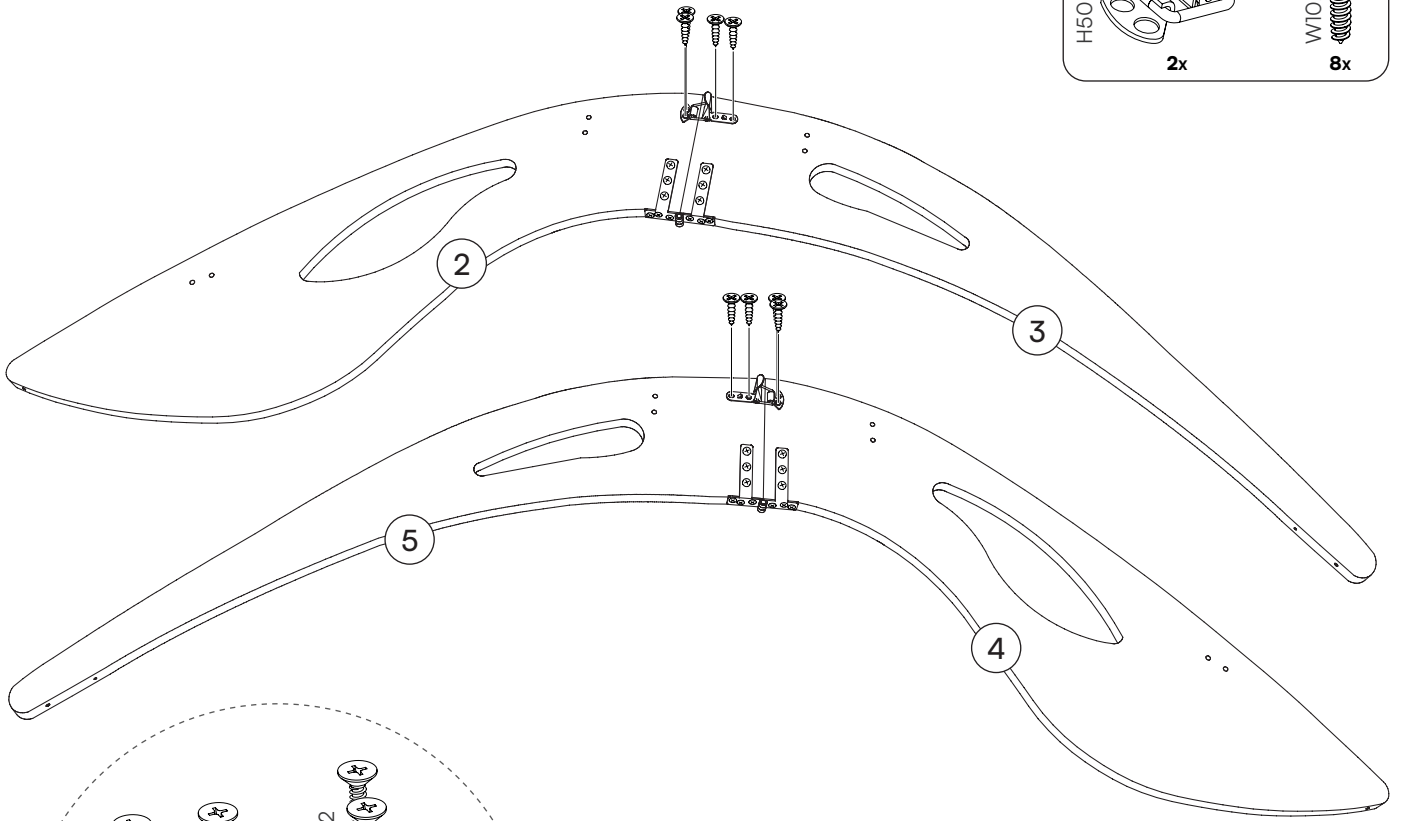
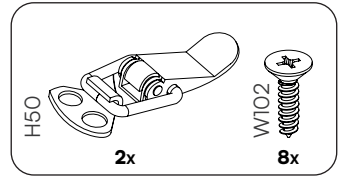

4

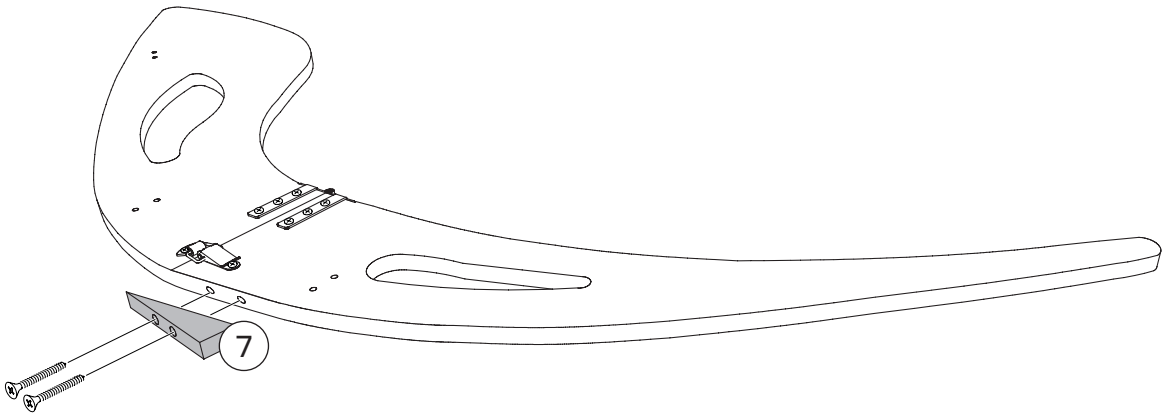
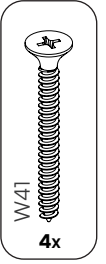
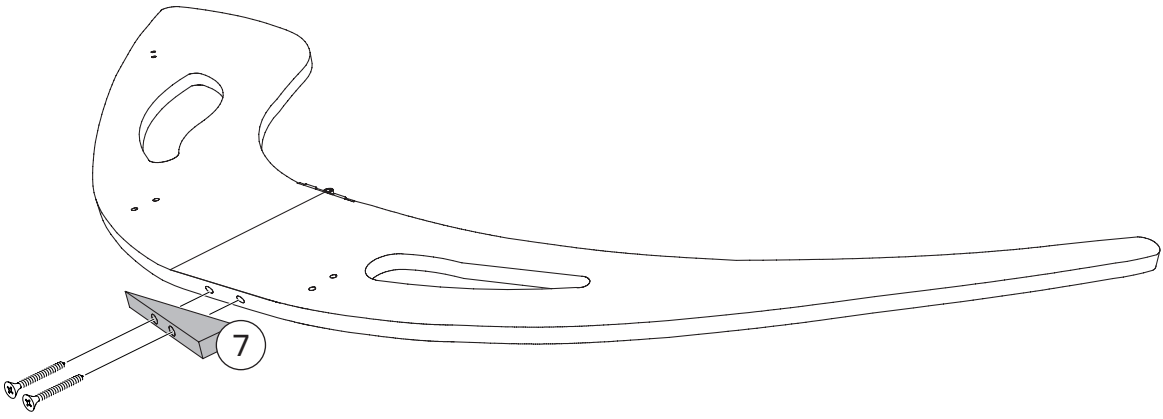

5

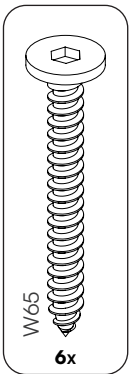
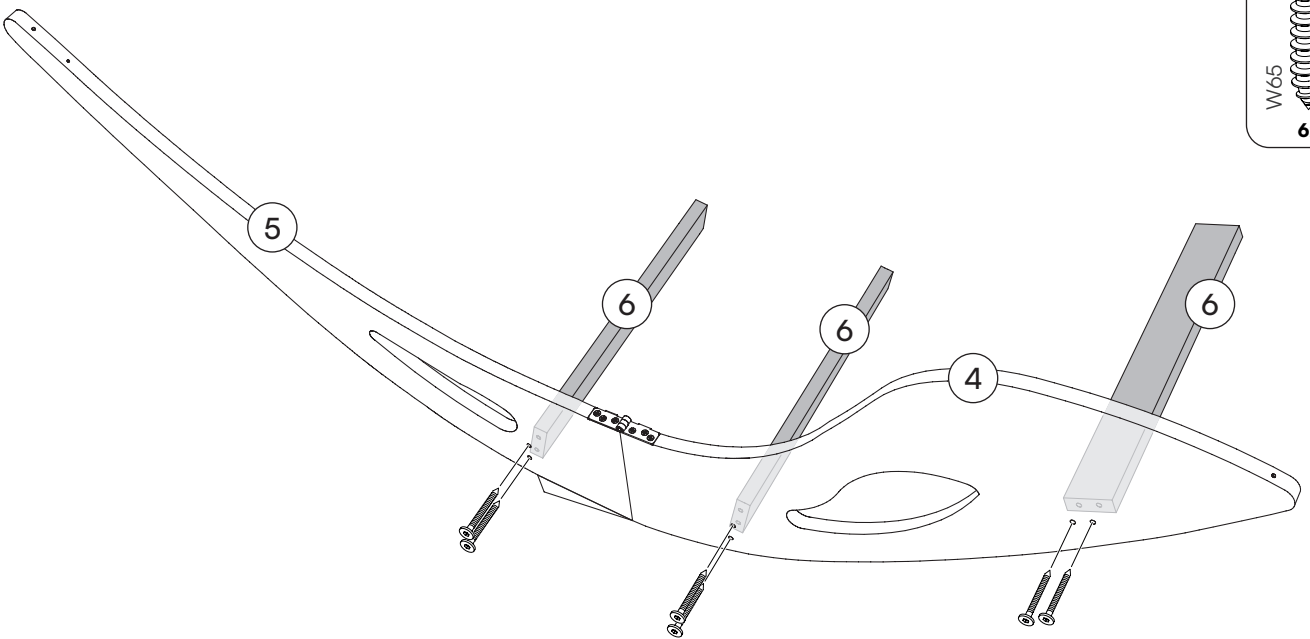

6

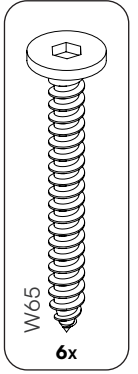
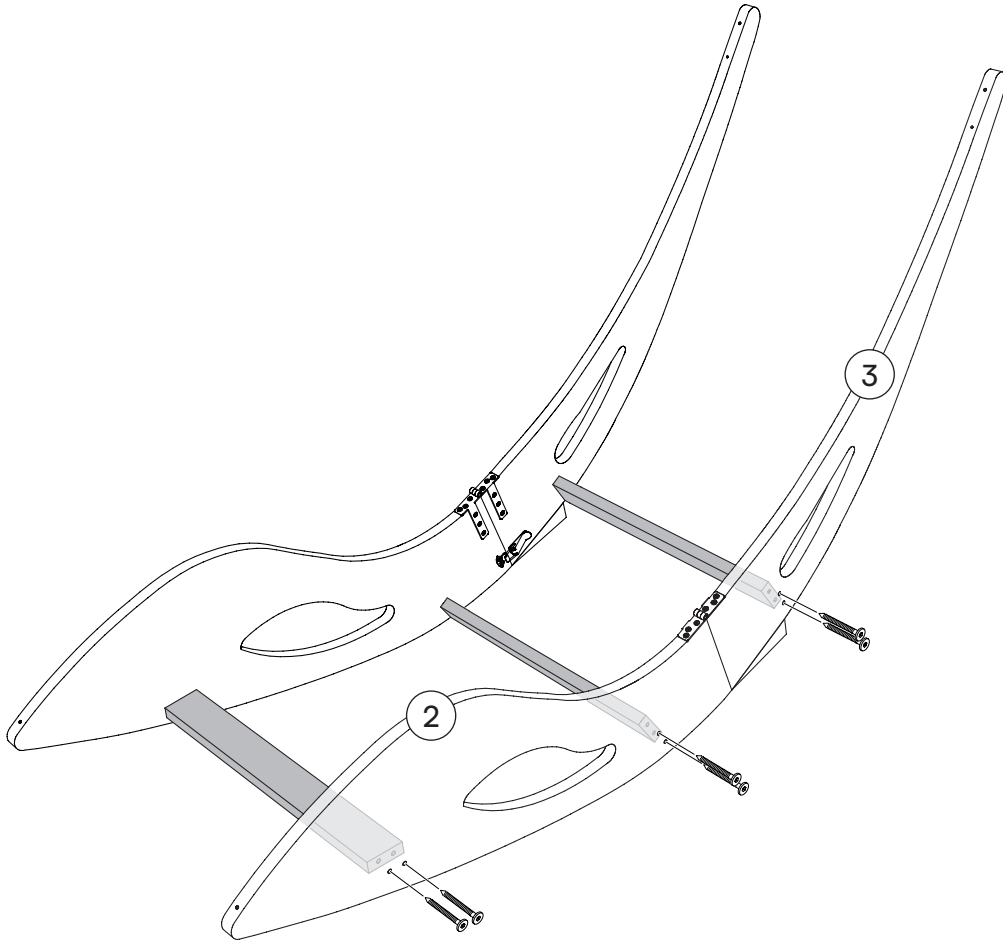

7

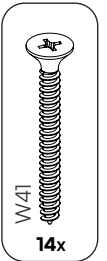
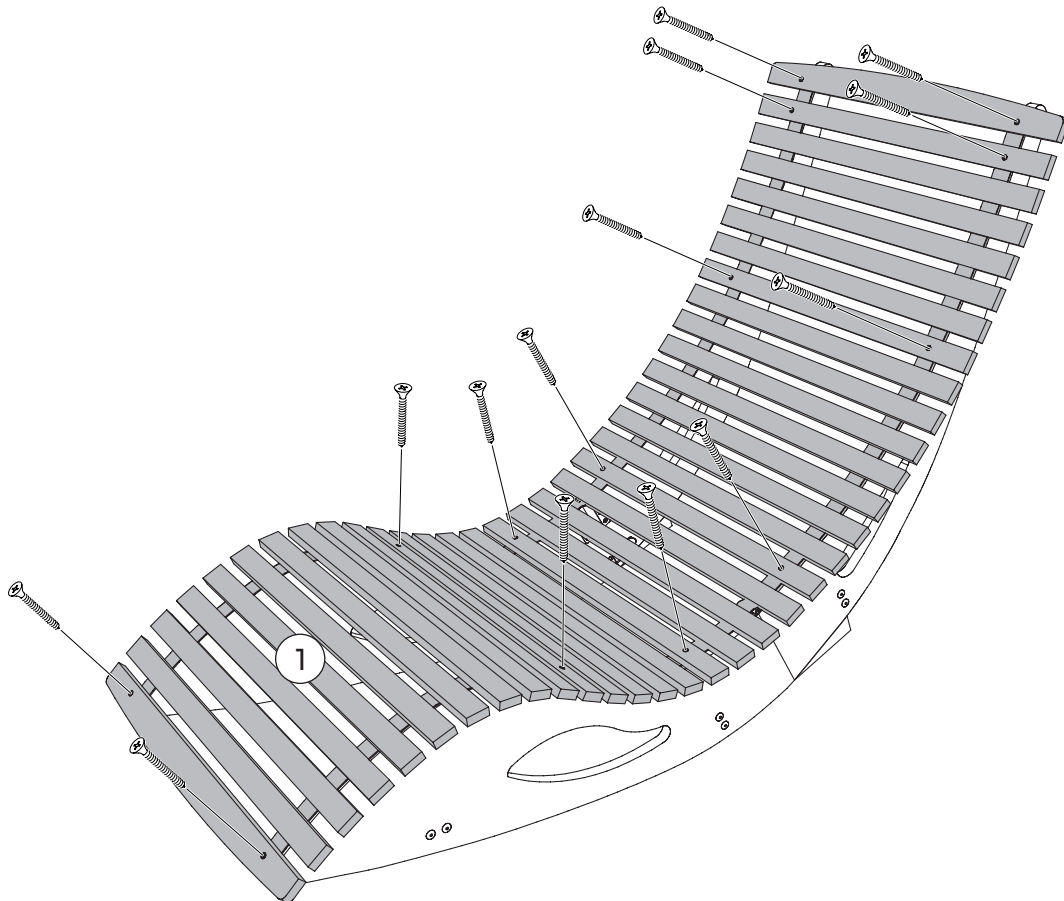

Geschafft!
●●●●●

STEELSON

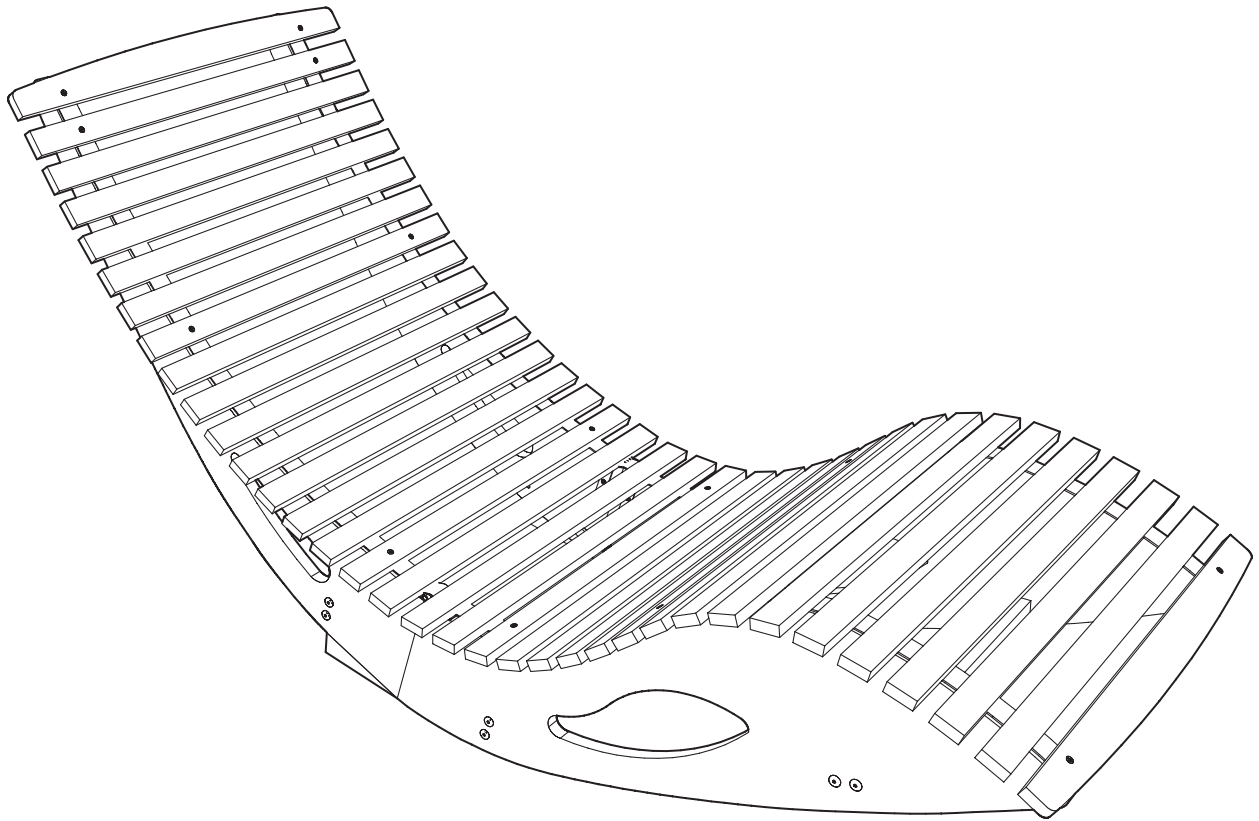

Fragen?

Wir sind für Dich da!

Scanne den QR-Code oder schreib uns an service@bela-living.de.
Gemeinsam kriegen wir jedes Problem gelöst!

