

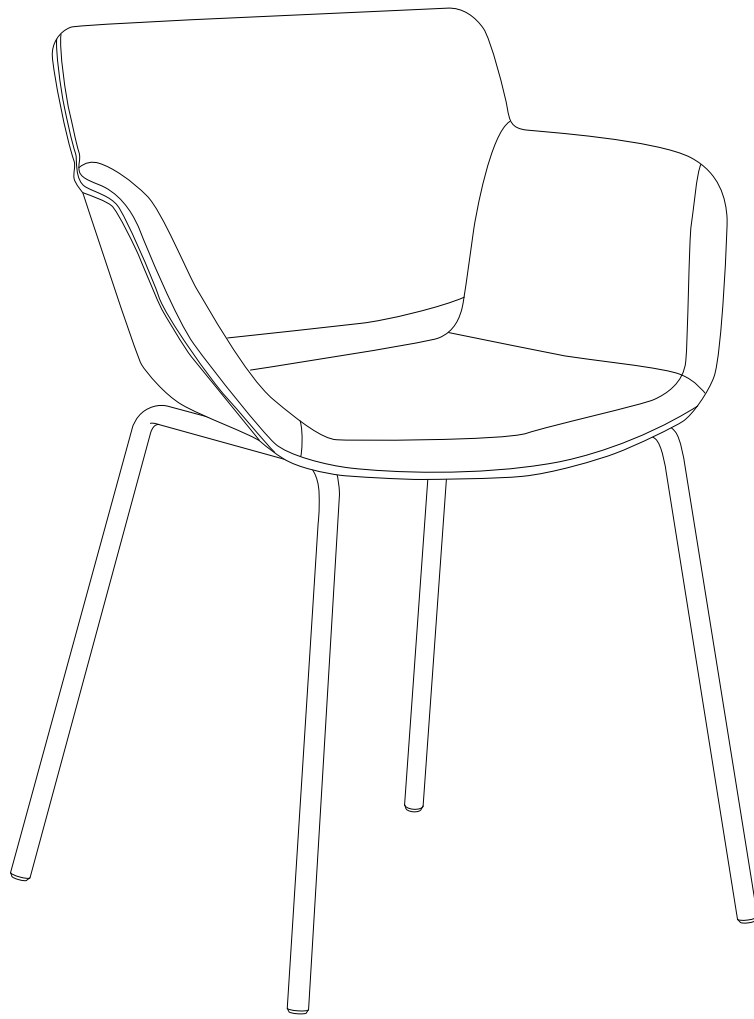

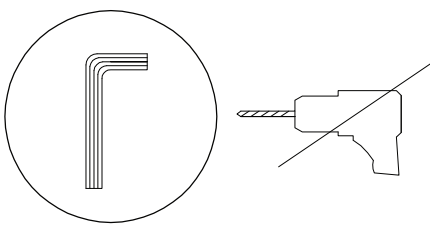



AXTEL



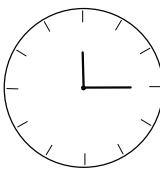
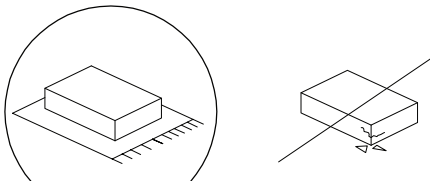

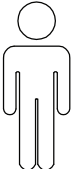
		
		15'
		
		2

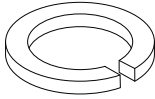
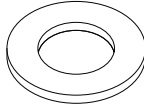
<p>A</p>  <p>M6 x 18</p> <p>x 4</p>	<p>B</p>  <p>x 4</p>	<p>C</p>  <p>x 4</p>
--------------------------------------------------------------------------------------------------------------------------------------------	---------------------------------------------------------------------------------------------------------------------	-----------------------------------------------------------------------------------------------------------------------

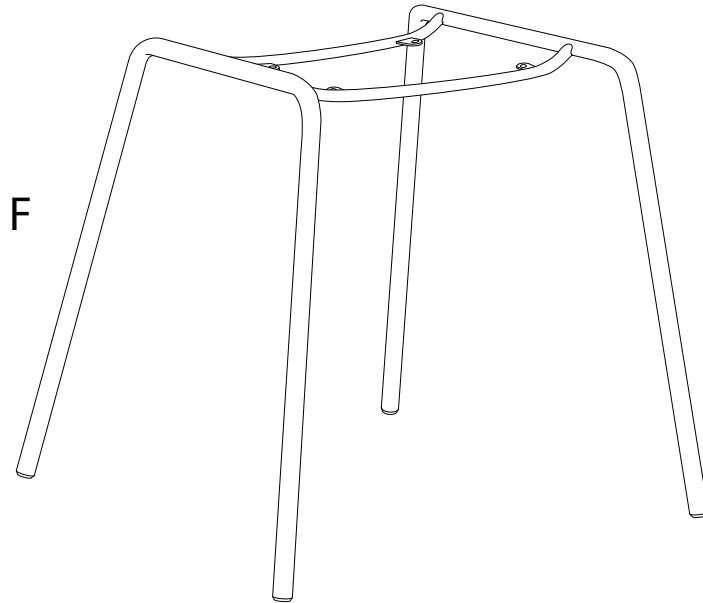
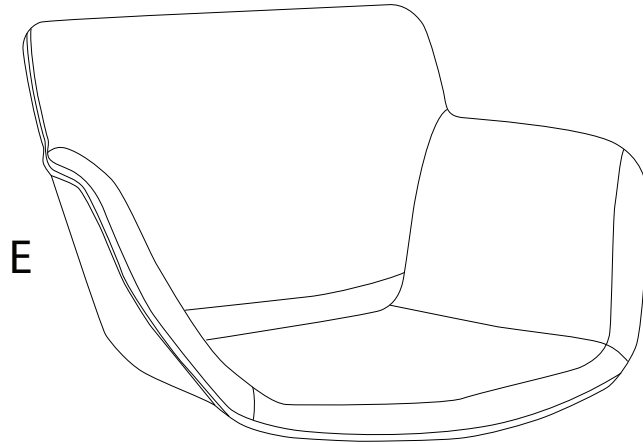

<p>D</p>  <p>x 1</p>	<p>E</p> <p>x 1</p>	<p>F</p> <p>x 1</p>
-----------------------------------------------------------------------------------------------------------------------	-----------------------------------	-----------------------------------

!

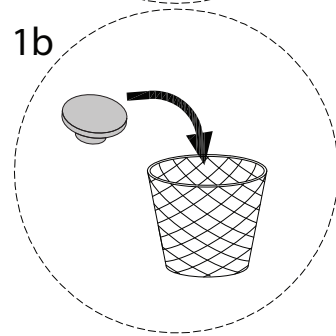
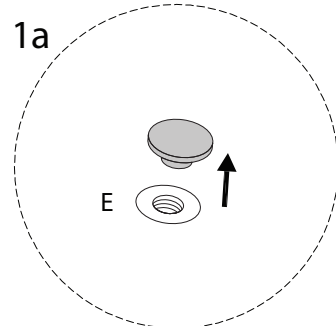
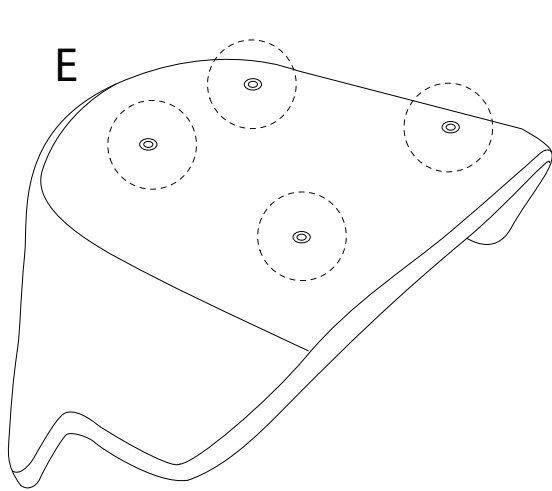

1

