

BESOS

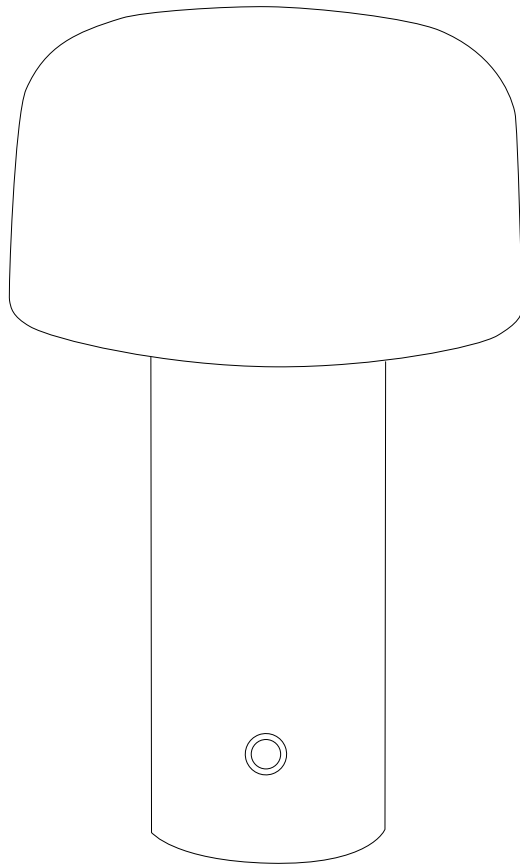

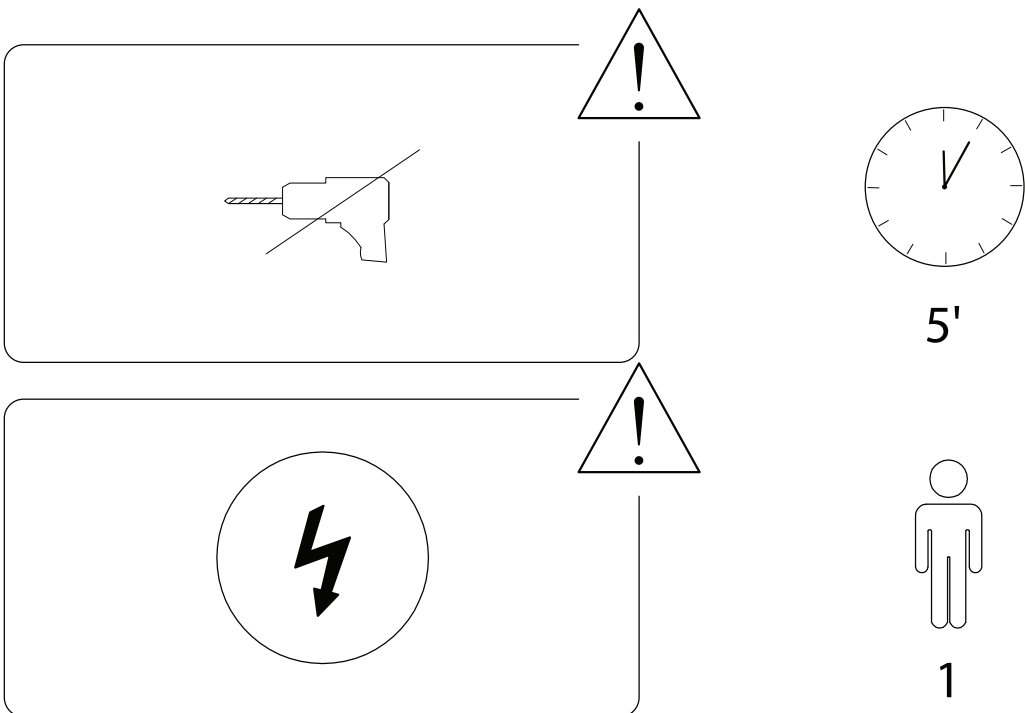
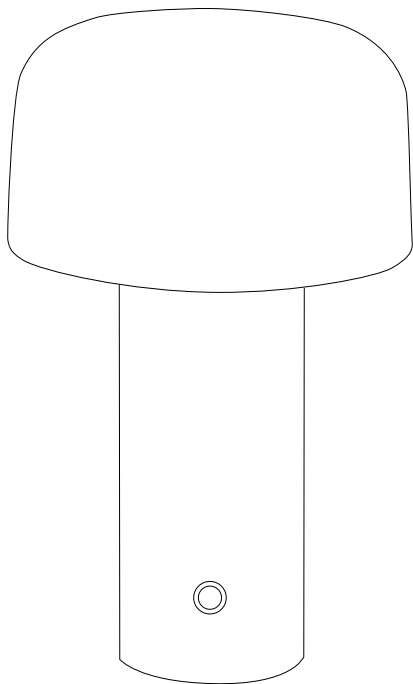

1/4

A

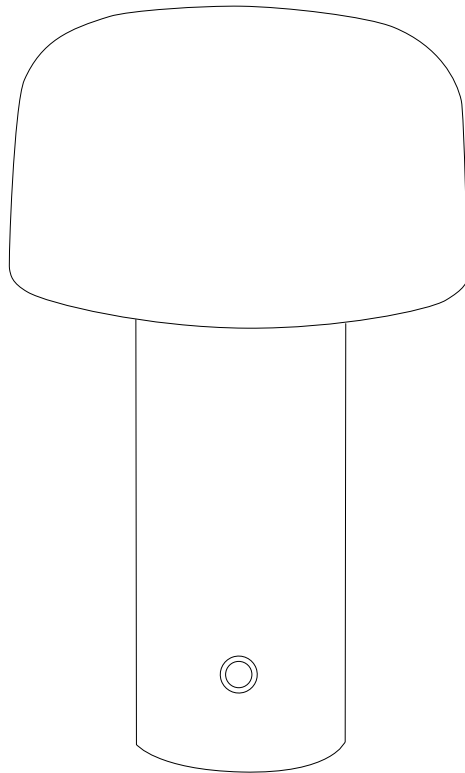

B

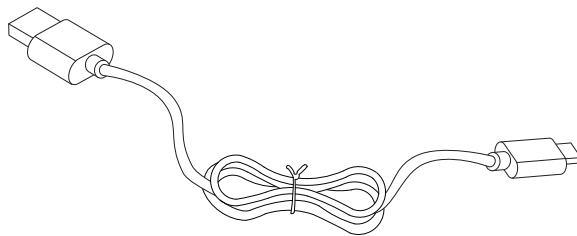

A

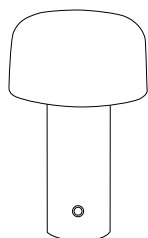

x 1

B

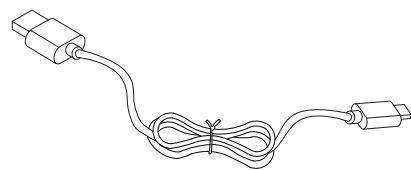

x 1

1

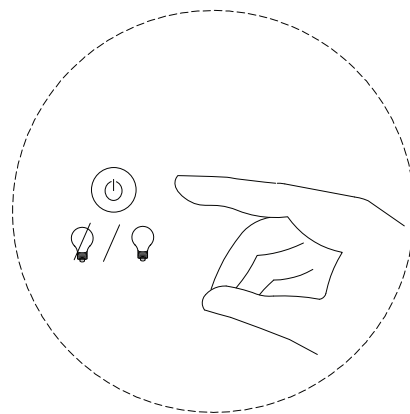
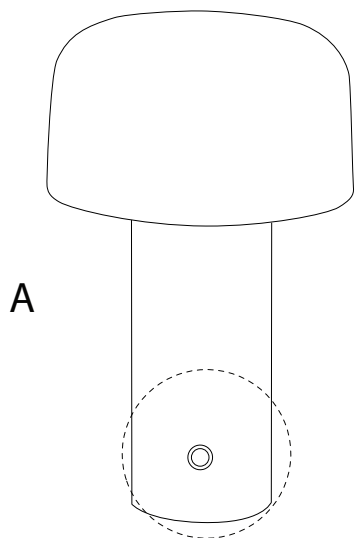
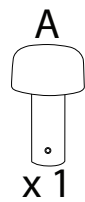

2

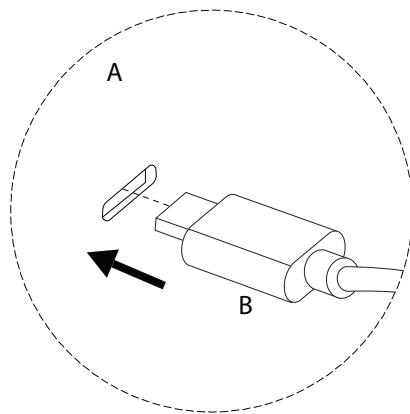
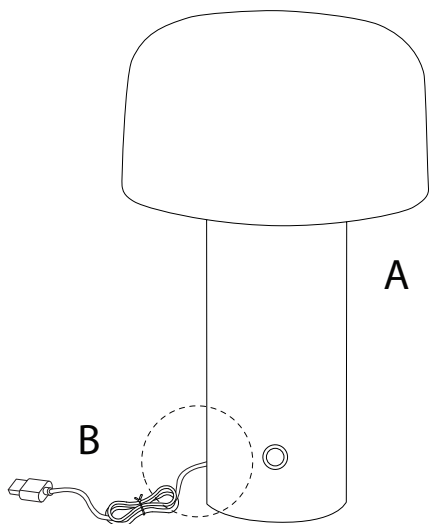
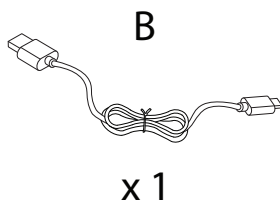

!

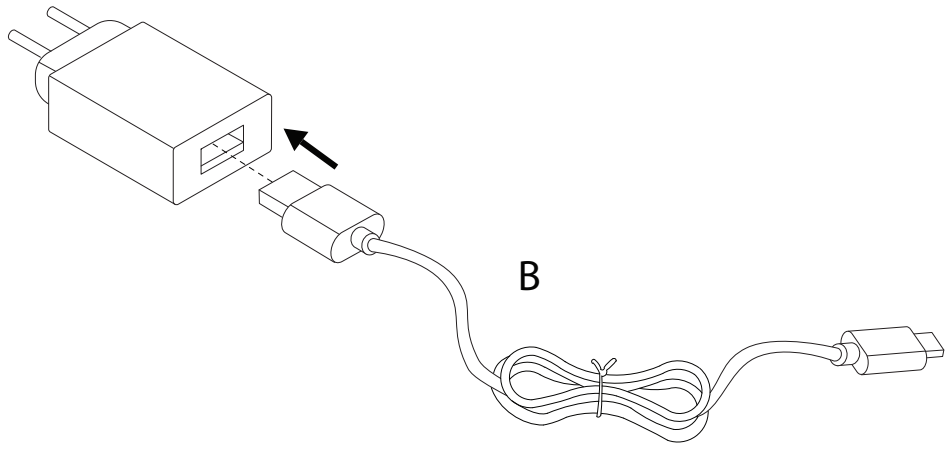

3

