

ALNES

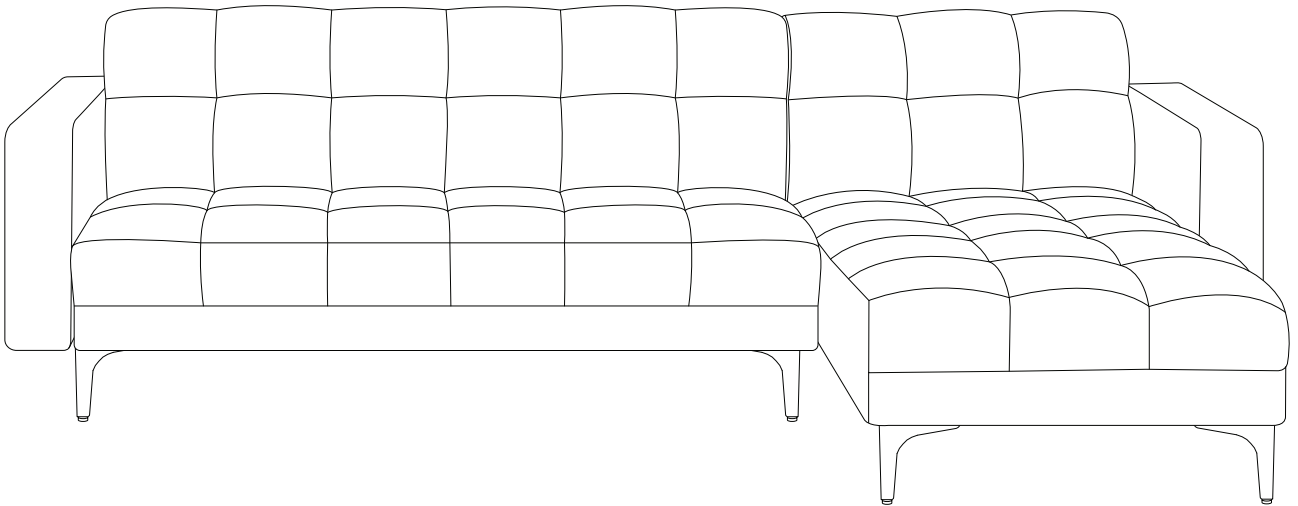

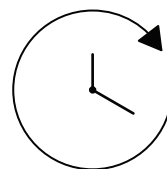

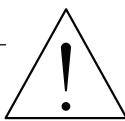

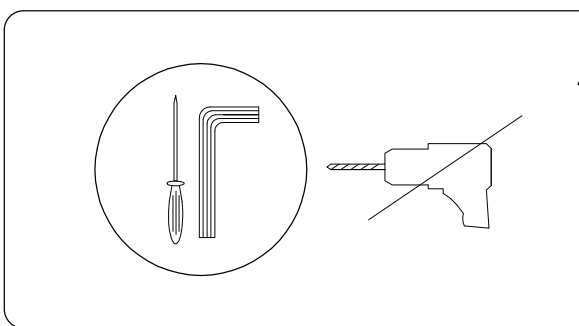
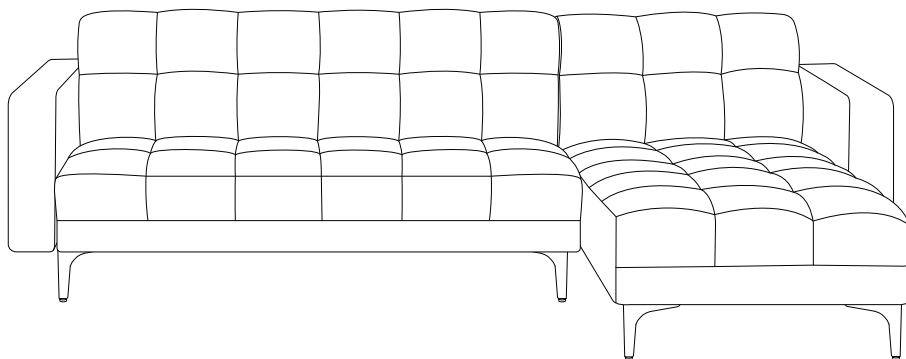
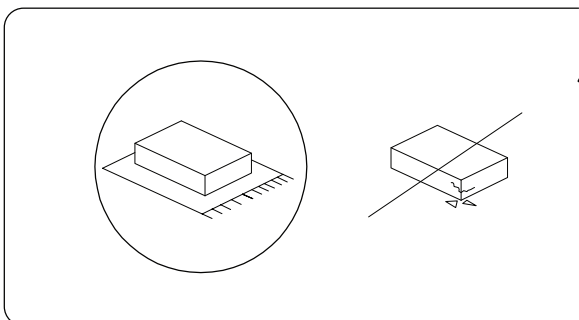

30'

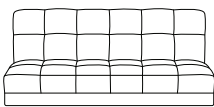
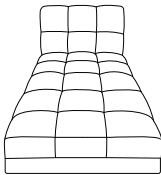

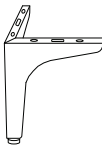
2

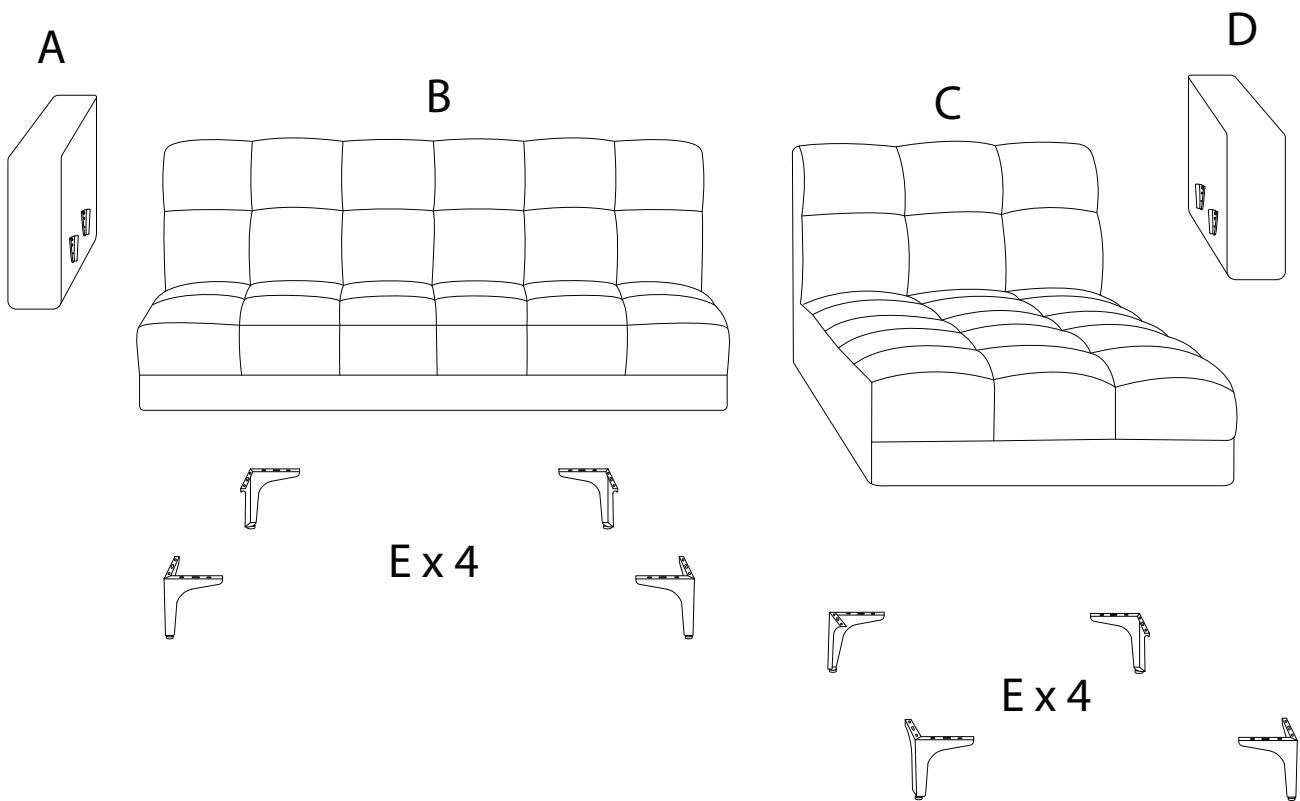
A	B	C	D	E
				
x 1	x 1	x 1	x 1	x 8

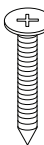
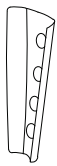

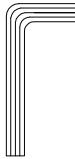
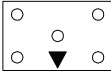
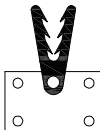
F	G	H	I	J	K
 M4 x 30		 M6 x 20			
x 52	x 4	x 8	x 1	x 2	x 2

!

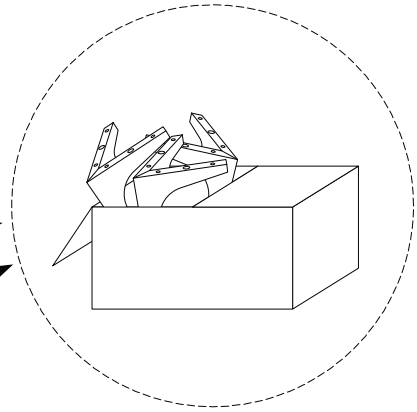
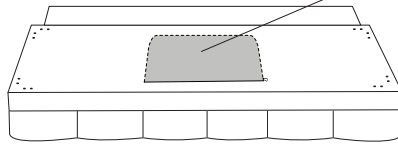
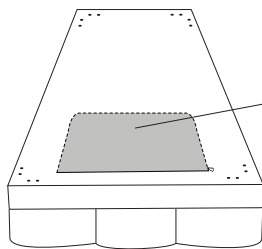
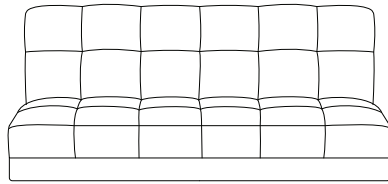
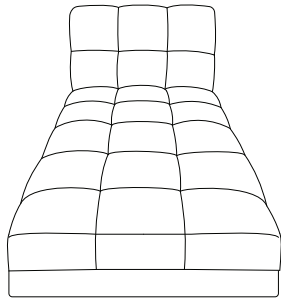

1

B

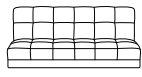

x 1

C

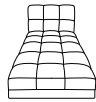

x 1

F

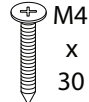

M4
x
30

x 20

J

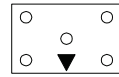

x 2

K

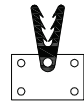

x 2

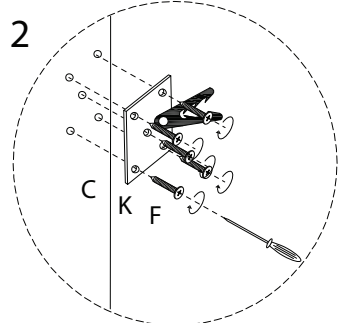
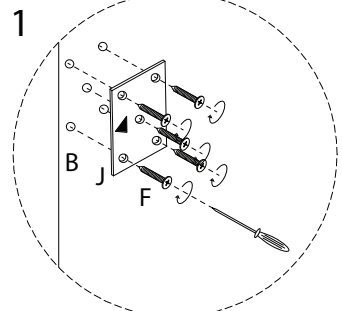
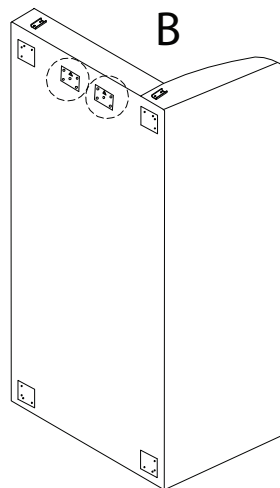
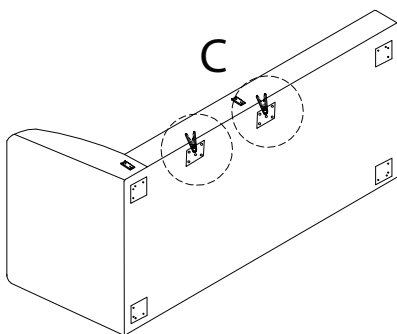

2

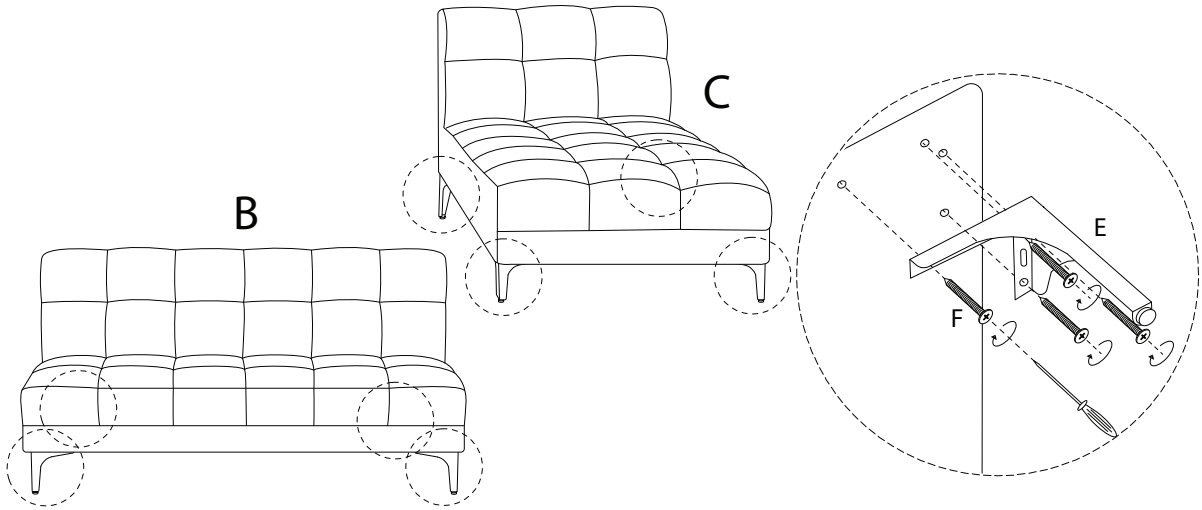
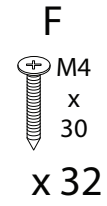

3

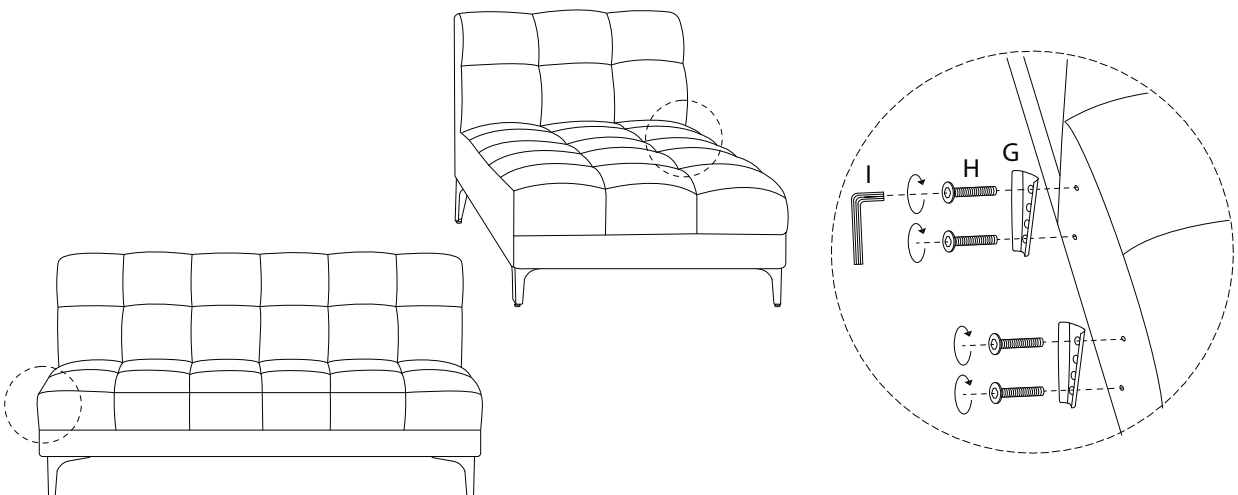
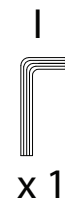
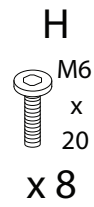
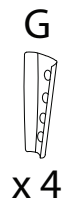

4

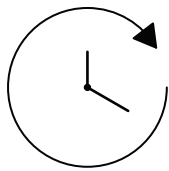
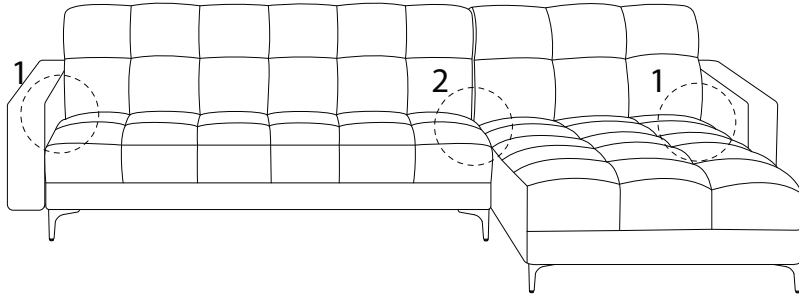

30'

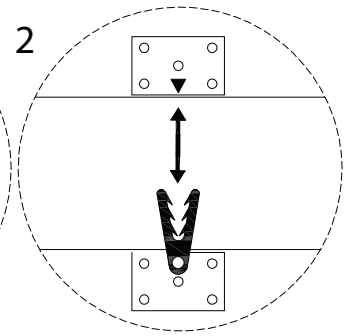
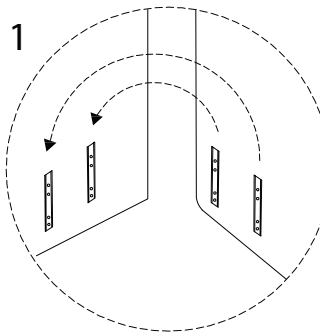

!

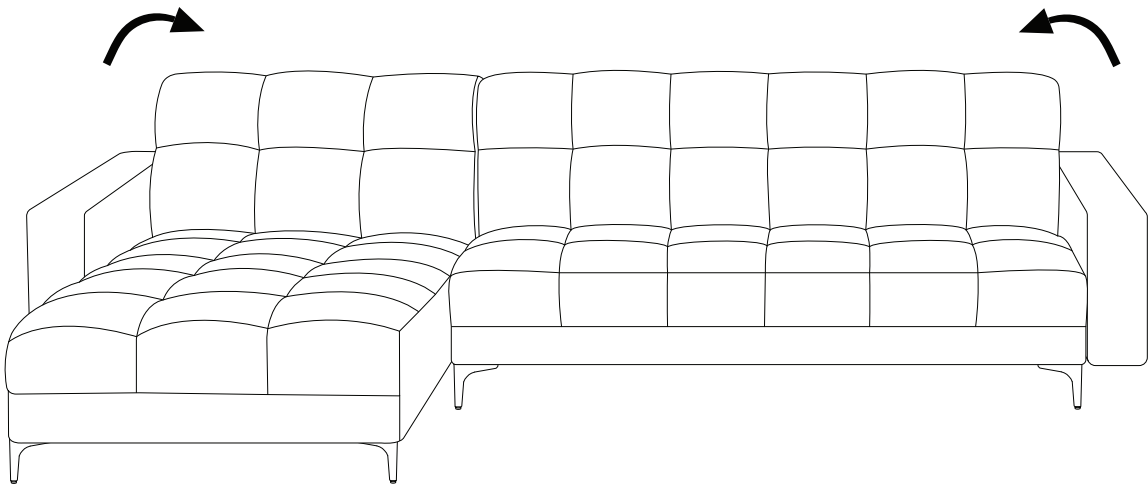

!

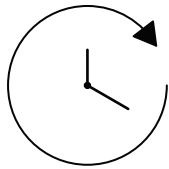
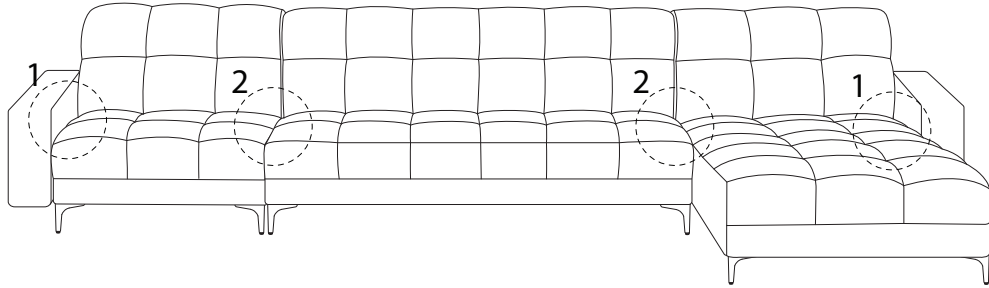

45'

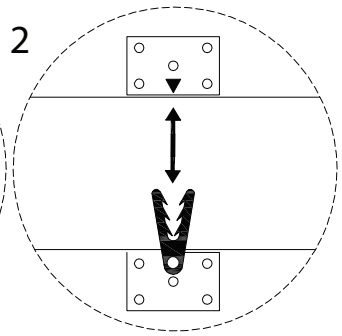
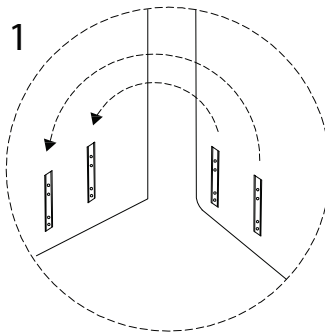

!

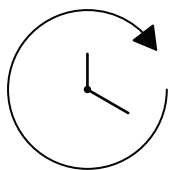
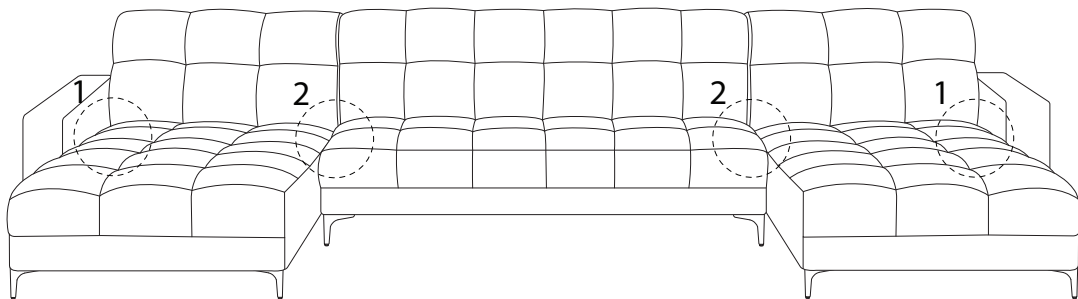

45'

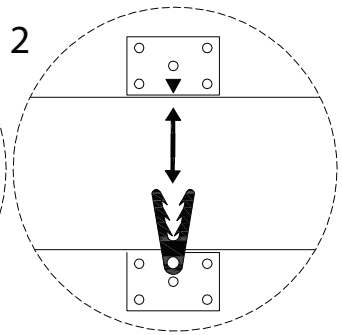
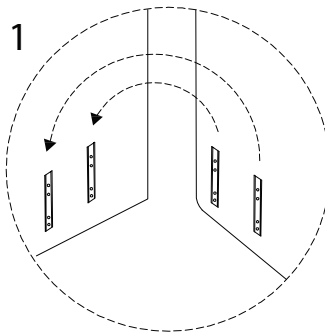

!

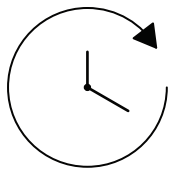
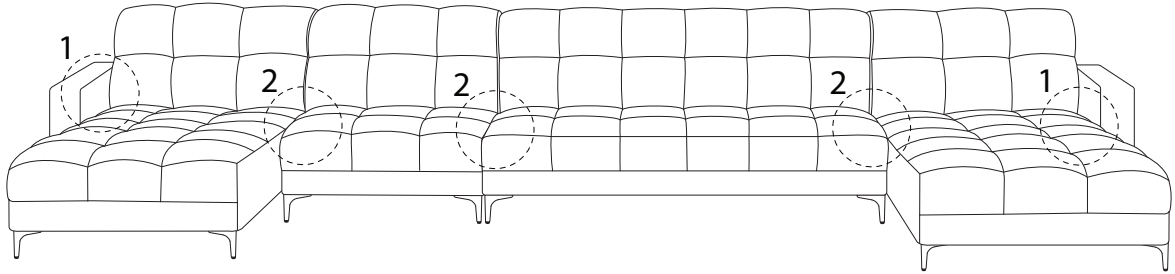

60'

